

ESPID 2022 ABSTRACT BOOK



40TH ANNUAL MEETING OF THE
**EUROPEAN SOCIETY FOR
PAEDIATRIC INFECTIOUS
DISEASES**

Organised jointly by ESPID and the ESPID Foundation



ATHENS
& ONLINE
9-13 MAY
2022



#ESPID2022

espidmeeting.org

RISK FACTORS FOR SEVERE COVID-19 IN HOSPITALIZED CANADIAN CHILDREN: A NATIONAL PROSPECTIVE STUDY

Parallel Symposium

PARALLEL SYMPOSIUM: COVID-19 IN CHILDREN

Daniel Farrar¹, Olivier Drouin², Charlotte Moore Hepburn³, Krista Baerg⁴, Kevin Chan⁵, Claude Cyr⁶, Elizabeth Donner⁷, Joanne Embree⁸, Catherine Farrell⁹, Sarah Forgie¹⁰, Ryan Giroux¹¹, Kristopher Kang¹², Melanie King¹³, Melanie Laffin¹³, Thuy Mai Luu², Julia Orkin³, Naim Ouldali¹⁴, Jesse Papenburg¹⁵, Catherine Pound¹⁶, Victoria Price¹⁷, Rupeena Purewal⁴, Jean-Phillippe Proulx-Gauthier¹⁸, Manish Sadarangani¹⁹, Marina Salvadori²⁰, Roseline Thibeault²¹, Karina Top²², Isabelle Viel-Thériault²³, Fatima Kakkar¹⁴, Shaun Morris²⁴

¹Hospital for Sick Children, Centre For Global Child Health, Toronto, Canada, ²CHU Sainte-Justine, Division Of General Pediatrics, Department Of Pediatrics, Montreal, Canada, ³Hospital for Sick Children, Division Of Paediatric Medicine, Toronto, Canada, ⁴University of Saskatchewan, Department Of Pediatrics, Saskatoon, Canada, ⁵University of Toronto, Department Of Pediatrics, Temerty Faculty Of Medicine, Toronto, Canada, ⁶Centre Hospitalier Universitaire de Sherbrooke, Service De Soins Intensifs Pédiatriques, Sherbrooke, Canada, ⁷Hospital for Sick Children, Division Of Neurology, Toronto, Canada, ⁸University of Manitoba, Department Of Paediatrics And Child Health, Winnipeg, Canada, ⁹CHU Sainte-Justine, Division Of Paediatric Intensive Care, Department Of Pediatrics, Montreal, Canada, ¹⁰University of Alberta, Division Of Infectious Diseases, Department Of Pediatrics, Edmonton, Canada, ¹¹Unity Health Toronto, Women's And Children's Health Program, St. Michael's Hospital, Toronto, Canada, ¹²University of British Columbia, Department Of Pediatrics, Vancouver, Canada, ¹³Canadian Paediatric Society, Canadian Paediatric Surveillance Program, Ottawa, Canada, ¹⁴CHU Sainte-Justine, Division Of Infectious Diseases, Montreal, Canada, ¹⁵Montreal Children's Hospital, Division Of Pediatric Infectious Diseases, Department Of Pediatrics, Montreal, Canada, ¹⁶Children's Hospital of Eastern Ontario, Division Of General Pediatrics, Department Of Pediatrics, Ottawa, Canada, ¹⁷Dalhousie University, Division Of Paediatric Hematology/oncology, Department Of Pediatrics, Halifax, Canada, ¹⁸CHU de Québec-Université Laval, Department Of Pediatrics, Quebec City, Canada, ¹⁹BC Children's Hospital, Vaccine Evaluation Center, Vancouver, Canada, ²⁰Public Health Agency of Canada, N/a, Ottawa, Canada, ²¹Centre Mère-Enfant Soleil du CHU de Québec, Département De Pédiatrie, Quebec City, Canada, ²²Dalhousie University, Department Of Pediatrics, Halifax, Canada, ²³CHU de Québec-Université Laval, Division Of Infectious Diseases, Department Of Pediatrics, Quebec City, Canada, ²⁴The Hospital for Sick Children, Infectious Disease, Toronto, Canada

Backgrounds: Comorbid conditions are a recognized risk factor for severe COVID-19 disease in children, though there is limited evidence regarding the risks associated with specific conditions. The objective of this study was to identify factors associated with severe COVID-19 among hospitalized children with SARS-CoV-2 infection in Canada.

Methods: We conducted a national prospective study on hospitalized children with microbiologically confirmed SARS-CoV-2 infection via the Canadian Paediatric Surveillance Program from March 2020-May 2021. Cases were reported voluntarily by a network of >2800 paediatricians and paediatric subspecialists. SARS-CoV-2 hospitalizations were classified as COVID-19-related, incidental infection, or infection control/social admissions. Severe disease was defined as intensive care, ventilatory, or hemodynamic requirements, select organ system complications, or death. Risk factors for severe disease were identified using multivariable Poisson regression, adjusting for child age and sex, coinfections, and timing of hospitalization.

Results: We identified 541 children hospitalized with SARS-CoV-2 infection, including 329 (60.8%) with COVID-19-related disease. Median age at admission was 2.8 years (IQR 0.3-13.5) and 42.9% (n=232) had at least one comorbidity. Among COVID-19-related hospitalizations, severe disease occurred in 29.5% of children (n=97/329), including a higher proportion of children aged 1-4 years (42.6%) and 12-17 years (41.3%). Comorbidities associated with severe disease are described in Figure 1, and included

technology dependence (adjusted risk ratio [aRR] 1.96, 95% confidence interval [CI] 1.31-2.95), neurologic conditions (aRR 1.87 95% CI 1.34-2.61), and pulmonary conditions (aRR 1.66, 95% CI 1.13-

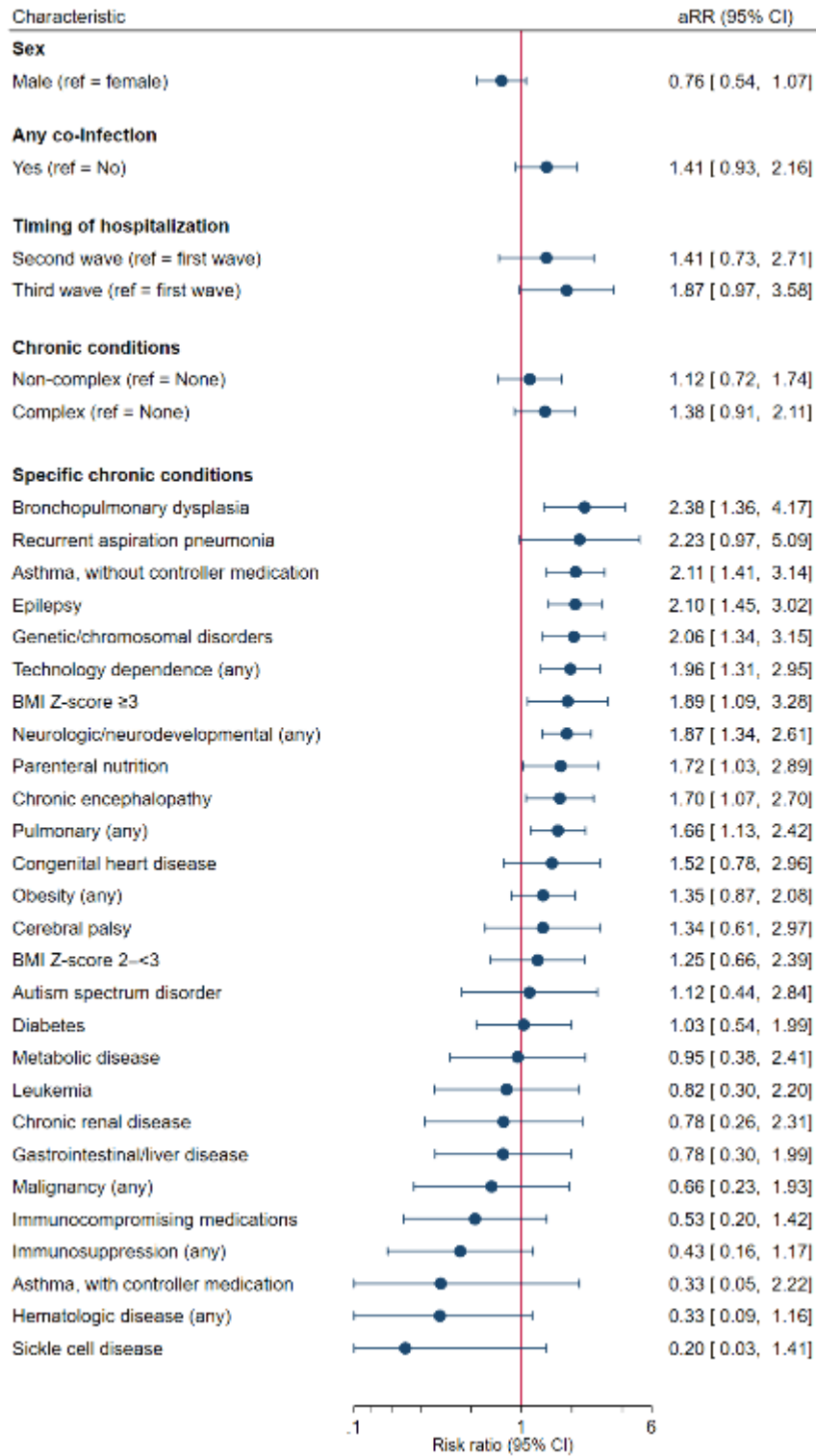

2.42).

Conclusions/Learning Points: While severe outcomes were detected at all ages and among patients with and without comorbidities, neurologic and pulmonary conditions as well as technology dependence were associated with increased risk of severe COVID-19. These findings may help guide vaccination programs and prioritize targeted COVID-19 therapies for children.

T CELL EXHAUSTION IS A FEATURE OF MIS-C RELATED IMMUNE RESPONSES

Parallel Symposium

PARALLEL SYMPOSIUM: COVID-19 IN CHILDREN

Harsita Patel¹, Michael Carter², Oliver Powell¹, Samuel Nichols¹, Matt Fish³, Paul Wellman⁴, Leire Estramiana-Elorrieta¹, Giselle D'Souza¹, Victoria Wright¹, Elizabeth Whittaker⁵, Shane Tibby⁴, Manu Shankar-Hari⁶, Michael Levin¹

¹Imperial College London, Department Of Infectious Disease, London, United Kingdom, ²King's College London, Department Of Women And Children's Health, London, United Kingdom, ³King's College London & NHS Guys Hospital, Peter Gorer Department Of Immunobiology, London, United Kingdom, ⁴Evelina London Children's Hospital, Paediatric Intensive Care, London, United Kingdom, ⁵Imperial Healthcare NHS Trust, Paediatric Infectious Diseases, London, United Kingdom, ⁶The Queen's Medical Research Institute, University of Edinburgh, Centre For Inflammation Research, Edinburgh, United Kingdom

Backgrounds: T cell lymphopaenia, and activation are well described features of MIS-C. We evaluated whether T cell exhaustion alongside T cell activation reported in childhood viral infections, occurs in children with a clinical diagnosis of MIS-C.

Methods: Clinical cohort: Children with febrile illnesses and healthy controls were recruited from two tertiary London hospitals between 01/09/2020-31/12/21, as part of the EU-funded DIAMONDS study. 162 participants were included: MIS-C (n=80), COVID-19 pneumonitis (n=7), Kawasaki disease (n=3), severe viral (n=7), and bacterial (n=19) illness, other inflammatory (n=8), paediatric controls (n=13), and adult vaccinated controls (n=25). Eighty-two of 124 patients (66%) required intensive care. Samples were collected at two time-points: acute illness at admission and convalescence. Qiagen SARS-CoV-2 QuantiFERON kits were used for stimulation of whole blood with mitogen and SARS-CoV-2 antigens, to stimulate CD4+ and CD8+ T cells, and subsequent measurement in the supernatant of IFN γ levels.

Results: The QuantiFERON assay was performed on 132 samples (acute n=59, convalescence n=19, paediatric controls n=11, adult controls n=25). MIS-C patients had raised baseline IFN γ levels, with lower increase after stimulation with SARS-CoV-2 antigens compared to vaccinated adults. The absolute increase in IFN γ in response to mitogen was lower in MIS-C compared to vaccinated adults, healthy children or bacterial infection. There was recovery in mitogen response in MIS-C in convalescence (Figure 1).

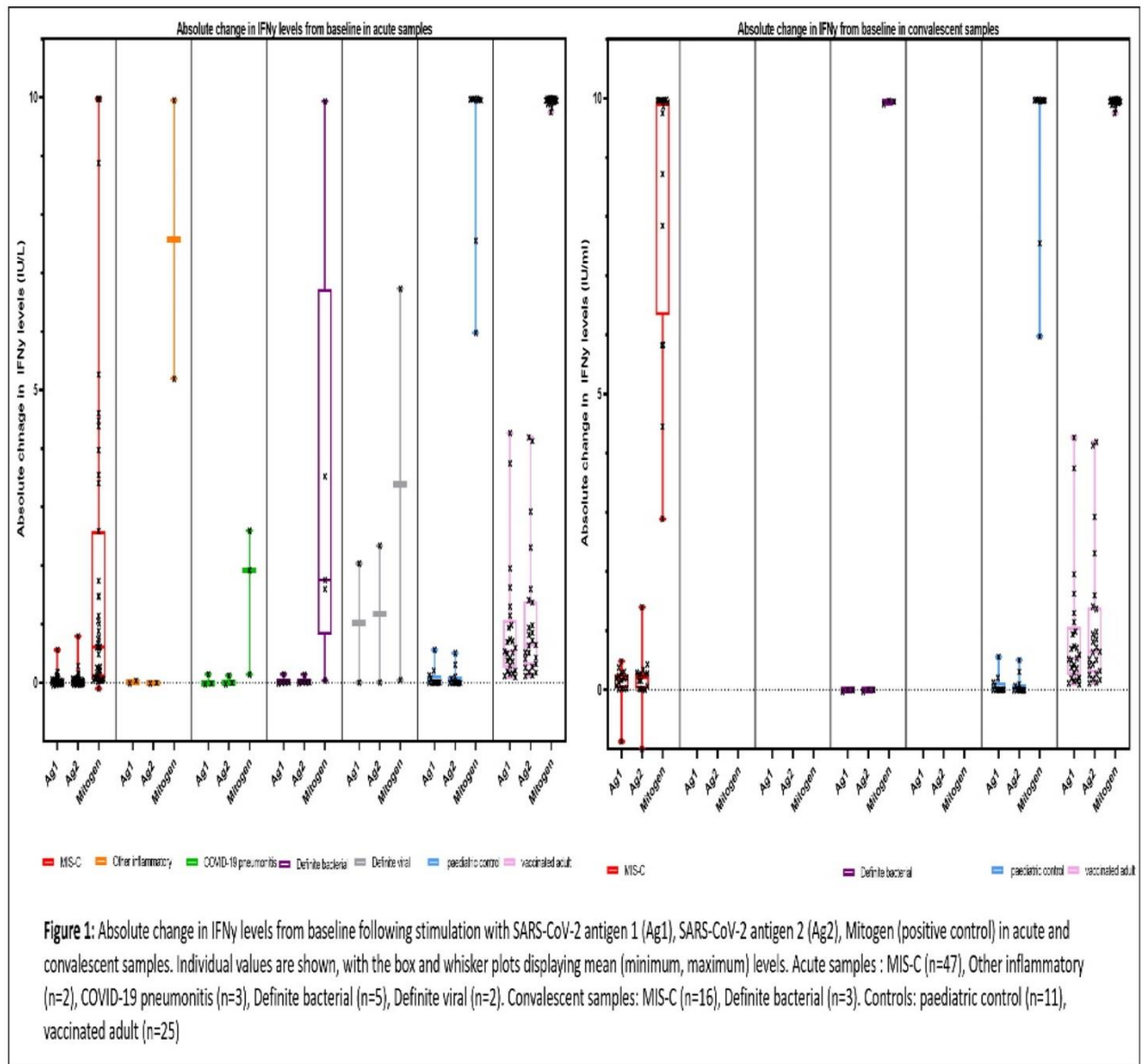

Conclusions/Learning Points: We report a high baseline IFN γ and low activation by SARS-CoV-2 peptides and mitogen, which suggests T cell exhaustion coexists with features of T cell activation in MIS-C. Further studies on molecular mechanisms of T cell exhaustion are warranted.

OP003 / #903

RISK OF SARS-COV-2 REINFECTIONS IN CHILDREN: PROSPECTIVE NATIONAL SURVEILLANCE, JANUARY 2020 TO JULY 2021, ENGLAND

Parallel Symposium

PARALLEL SYMPOSIUM: COVID-19 IN CHILDREN

Anna Mensah

UK Health Security Agency, Immunisation And Vaccine Preventable, London, United Kingdom

Backgrounds: Reinfection after primary SARS-CoV-2 infection is uncommon in adults, but little is known about the risks, characteristics, severity or outcomes of reinfection in children.

Methods: We used national SARS-CoV-2 testing data in England to estimate the risk of reinfection ≥ 90 days after primary infection from 01 January 2020 to 31 July 2021, which encompassed both the Alpha and Delta waves in England. Disease severity was assessed by linking reinfection cases to national hospitalisation, intensive care admission and death registrations datasets.

Results: Reinfection rates closely followed community infection rates, with a small peak during the Alpha wave and a larger peak during the Delta wave. In children aged ≤ 16 years, there were 688,418 primary infections and 2,343 reinfections. The overall reinfection rate was 66.88/100,000 population, being higher in adults (72.53/100,000) than in children (21.53/100,000). Reinfection rates after primary infection were 0.68% overall, 0.73% in adults and 0.34% in children. Of the 109 reinfections in children admitted to hospital, 78 (72%) had underlying comorbidities. Hospitalisation rates were similar for the first (64/2343, 2.73%) and second episode (57/2343, 2.43%). Intensive care admission was rare after primary infection ($n=7$) or reinfection ($n=4$), mainly in children with comorbidities. 44 deaths occurred after primary infection within 28 days of diagnosis (44/688,418, 0.01%), none after possible reinfections.

Conclusions/Learning Points: The risk of SARS-CoV-2 reinfection is strongly related to exposure due to community infection rates, especially during the Delta variant wave. Children had a lower risk of reinfection than adults, but reinfections were not associated with more severe disease or fatal outcomes.

MULTIDRUG RESISTANT BACTERIA COLONIZATIONS IN PAEDIATRIC PATIENTS WITH CANCER OR HEMATOPOIETIC STEM CELL TRANSPLANTATION IN SPAIN

Parallel Symposium

PARALLEL SYMPOSIUM: TREATMENT OF MDR GRAM (-) INFECTIONS IN CHILDREN - PREVENTION IS BEST

Angela Manzanares¹, David Aguilera², Pablo Escribano³, Eloísa Cervantes⁴, Mónica Camacho¹, Raquel Olivas⁵, Laura Calle-Miguel⁶, Serafín Castellano⁷, Alba González Guerrero⁷, Carmen Rodríguez-Vigil³, Yurena Aguilar De La Red³, Mercedes Plaza Fornieles⁴, Maria Baro⁸, Cristina Epalza⁹, Javier Fernández Domínguez¹⁰, Yasmina Mozo¹¹, Luis Escosa-García¹², Carmen Garrido², Teresa Vicente¹³, Jesús Saavedra Lozano²

¹HOSPITAL 12 DE OCTUBRE, Paediatrics, MADRID, Spain, ²Hospital General Universitario Gregorio Marañón, Paediatrics, Madrid, Spain, ³HOSPITAL MIGUEL SERVET, Pediatrics, ZARAGOZA, Spain, ⁴HOSPITAL CLÍNICO UNIVERSITARIO VIRGEN DE LA ARRIXACA, Pediatrics, MURCIA, Spain, ⁵HOSPITAL CLINICO UNIVERSITARIO DE VALENCIA, Paediatrics, VALENCIA, Spain, ⁶HOSPITAL UNIVERSITARIO CENTRAL DE ASTURIAS, Pediatrics, OVIEDO, Spain, ⁷HOSPITAL UNIVERSITARIO LA PAZ, Pediatrics, MADRID, Spain, ⁸HOSPITAL 12 DE OCTUBRE, Paediatric Hematooncology, MADRID, Spain, ⁹Hospital 12 Octubre, Pediatrics, Madrid, Spain, ¹⁰HOSPITAL UNIVERSITARIO CENTRAL DE ASTURIAS, Microbiology, OVIEDO, Spain, ¹¹Hospital Universitario La Paz, Paediatric Infectious Diseases Unit, Department Of Paediatrics, Madrid, Spain, ¹²Hospital La Paz, Pediatric Infectious Diseases, Madrid, Spain, ¹³HOSPITAL UNIVERSITARIO GREGORIO MARAÑÓN, Microbiology, MADRID, Spain

Backgrounds: Multidrug resistant bacteria (MDRB) infections are a rising concern, especially those associated with healthcare environments. The aims of this study were to describe the characteristics of MDRB colonizations in paediatric patients admitted to a Haemato-Oncology ward and to establish the risk of having a MDRB infection in a patient previously colonised.

Methods: Multicentre prospective observational study from May 2021-March 2022 in Spain. Patients < 18 years with diagnosis of cancer or hematopoietic stem cell transplantation (HSCT) admitted to Hemato-Oncology wards, were included. Rectal and nasal swabs for MDRB detection were performed at inclusion and periodically during a 90-day follow-up period. Active infection surveillance was performed during follow-up. Data of colonization at baseline is presented.

Results: 111 patients were included: Median age was 8 (± 5) years and 60 (54,1%) were women. Most common diagnosis were leukemia (52;46.8%), solid tumour (43;38.7%), sickle cell disease (SCD) (6;5.4%) and lymphoma (4;3.6%). 20 (18%) had undergone a HSCT. 14 (12.6%) had a MDRB colonization at baseline and 3 (2.7%) a double colonization. MDRB detected were ESBL-producing enterobacteria (7;50%), carbapenemase-producing enterobacteria (6;42.9%), MDR-Pseudomonas (2;14.3%) and MRSA (1;7.1%). No MDR-Acinetobacter or vancomycin-resistant Enterococcus were detected. The main ESBL-producing enterobacteria was E. coli (75%) and the main carbapenemase detected, VIM (66.7%). Risk factors for MDRB colonization were SCD diagnosis ($p=0.03$) and a previous colonization ($p<0.01$). Children with colonizations were more likely to have a HSCT and their father's were more likely to have been born abroad, with no statistical significance.

| Characteristics in patients with vs. without MDRB colonisation | | | |
|--|-----------------------------|-------------------------|-----------------|
| | Non MDRB-colonized n= 91 | MDRB-colonized n= 14 | p |
| Age (years) | 7.9 (2.9-13) | 6.2 (3.5-9.5) | 0.70 |
| Women | 51 (52.6) | 9 (64.3) | 0.41 |
| Medical condition: | | | |
| • Leukemia | 46 (47.4) | 6 (42.9) | 0.74 |
| • Lymphoma | 4 (4.1) | 0 | 1.00 |
| • Solid tumour | 38 (39.2) | 5 (35.7) | 0.84 |
| • Sickle cell disease | 3 (3.1) | 3 (21.4) | 0.03 |
| • Others | 6 (6.2) | 0 | |
| Stem cell transplantation | 15 (16.5) | 5 (35.7) | 0.06 |
| Born abroad | 10 (10.3) | 2 (14.3) | 0.65 |
| Mother born abroad | 33 (34.0) | 7 (50) | 0.24 |
| Father born abroad | 33 (34.0) | 8 (61.5) | 0.07 |
| Pets at home | 34 (35.4) | 3 (21.4) | 0.21 |
| Number of cohabitants at home | 4 (3-4.5) | 4 (3-5.5) | 0.98 |
| Previous known colonization | 8 (8.2) | 9 (64.3) | <0.01 |
| Medical history (90 days previous to inclusion) | | | |
| Number of admissions | 2 (1-4) | 2.5 (1-5) | 0.54 |
| Days of admission | 17 (6-29) | 15 (7.5-59.2) | 0.69 |
| Central venous catheter (cvc) | 78 (80.4) | 13 (92.9) | 0.26 |
| - Days with cvc | 90 (24.5-90) | 90 (82-90) | 0.16 |
| ICU admission | 22 (22.7) | 3 (21.4) | 1.00 |
| - Days of ICU admission | 3 (1-9.5) | 8 (1-8) | 0.53 |
| Severe neutropenia (< 500 nt mm ³) | 3 (0-18.5) | 0 (0-1.5) | 0.86 |
| Surgery | 34 (35.1) | 3 (21.4) | 0.54 |
| Total days receiving antibiotics | 12.4 (± 21) | 13.6 (±19) | 0.87 |
| Use of: | | | |
| - Anti-Pseudomonal cephalosporins | 27 (27.8) | 3 (21.4) | 0.75 |
| - Anti-Pseudomonal carbapenems | 14 (14.4) | 3 (21.4) | 0.44 |
| - Aminoglycosides | 8 (8.2) | 2 (14.3) | 0.61 |
| - Glycopeptides | 19 (19.6) | 3 (21.4) | 1.00 |
| - Piperacilin-tazobactam | 26 (26.8) | 2 (14.3) | 0.25 |
| - Fluoroquinolones | 17 (17.5) | 2 (14.3) | 1.00 |

continuous variables: median (SD); categorical variables: count (%)

Conclusions/Learning Points: Rates of ESBL and carbapenemase-producing enterobacteria colonization in a cohort of paediatric patients with cancer or SCT in Spain was high. Children with SCD and a previous colonization have a higher risk

OP005 / #362

EPIDEMIOLOGY AND OUTCOMES OF GRAM-NEGATIVE BACTEREMIA IN A TERTIARY UNIVERSITY HOSPITAL IN MADRID, SPAIN (2018-2020).

Parallel Symposium

PARALLEL SYMPOSIUM: TREATMENT OF MDR GRAM (-) INFECTIONS IN CHILDREN - PREVENTION IS BEST

Alberto Muñoz¹, Sara Domínguez², Sara Villanueva², Cristina Epalza¹, Daniel Blázquez-Gamero¹, Elisa Fernández¹, Cinta Moraleda³, Angela Manzanares¹, David Torres¹, Serena Villaverde¹, Silvia Corrales¹, Luis Prieto¹

¹HOSPITAL 12 DE OCTUBRE, Paediatrics, MADRID, Spain, ²HOSPITAL 12 DE OCTUBRE, Clinical Trials Unit, MADRID, Spain, ³Foundation for Biomedical Research Hospital 12 de Octubre, Instituto De Investigación 12 De Octubre (imas12), Madrid, Spain

Backgrounds: Gram-negative bacteremia (GNB) is associated with a significant rate of morbidity and mortality in adults. Moreover, resistances to antibiotics are increasingly described in surveillance reports. However, the epidemiology and outcomes of GNB in children are not well known. We aimed to analyze GNB bacteremia in pediatric patients in a tertiary hospital over a three years period.

Methods: A retrospective, observational study of bacteremia episodes caused by Enterobacteriaceae or non-fermentative GNB in pediatric patients between January of 2018 and December 2020 in a Tertiary Hospital from Madrid, Spain, was carried out through microbiology charts and clinical records.

Demography, comorbidities, risk factors and infection characteristics were recorded, and bacterial strain and antibiotic resistance were registered. Three primary endpoints were defined: mortality, bacteremia persistence and recurrence. A statistical analysis was applied to assess differences in these outcomes according to the risk factors. A multivariable logistic regression analysis was used to assess the association between bacteria resistance and mortality.

Results: One hundred eighteen cases of GNB in one hundred and seven patients were included. The characteristics of the patients are shown in Table 1. In fifty-three cases (44.9%) GNB presented resistance to at least one group of antibiotic and in nine (7.6%) were multidrug-resistant (Table 1). The incidence of resistance rates by years were stable. Indwelling urinary catheterization was a risk factor associated to mortality [OR 3.48 (1.20-10.6)] and parenteral nutrition was related to persistent bacteremia [OR 7.69 (1.1-209)]. No relation between drug resistance and mortality was observed in multivariable analysis.

TABLE 1. DEMOGRAPHIC AND CLINICAL CHARACTERISTICS OF PATIENTS AND ISOLATED PATHOGENS.

| DEMOGRAPHIC AND CLINICAL DATA OF PATIENTS | | | | | |
|---|------------|-----------------|----------|-----------|--------------------|
| Total number of patients n | 107 | | | | |
| Gender n (%) | | | | | |
| Male | 60 (56%) | | | | |
| Female | 47(44%) | | | | |
| Age | | | | | |
| Months (median [IQR]) | 1 [0-9] | | | | |
| Years (mean) | 1.39 | | | | |
| Comorbidities n (%) | | | | | |
| Congenital cardiopathy | 22 (20%) | | | | |
| Prematurity | 37 (34.5%) | | | | |
| Leukemia/ lymphoma | 6 (5.6%) | | | | |
| Solid organ tumor | 3 (2.8%) | | | | |
| Primary immunodeficiency | 4 (3.7%) | | | | |
| Immunosuppression | 6 (5.6%) | | | | |
| Risk factors n (%) | | | | | |
| Previous hospitalization (three months) | 87 (81.3%) | | | | |
| Surgery (previous month) | 50 (46.7%) | | | | |
| Antibiotherapy (previous three months) | 75 (70%) | | | | |
| MDR bacteria colonization | 16 (14.9%) | | | | |
| Urinary catheter | 35 (32.7%) | | | | |
| Parenteral nutrition | 41 (38.3%) | | | | |
| Endpoints n (%) | | | | | |
| Mortality | 17 (15.8%) | | | | |
| Bacteremia persistence | 6 (5.6%) | | | | |
| Bacteremia recurrence | 3 (2.8%) | | | | |
| CHARACTERISTICS OF ISOLATED PATHOGENS | | | | | |
| Pathogen | Number (%) | Resistant n(%)* | MDR n(%) | ESBL n(%) | Carbapenemase n(%) |
| Total positive BC | 118 | 53 (44.9%) | 9 (7.6%) | - | - |
| Escherichia Coli | 30 (25.4%) | 13 (43.3%) | 1 (3.3%) | - | - |
| Klebsiella pneumoniae | 24 (20.3%) | 7 (29.1%) | 2 (8.3%) | 3 (12.5%) | 1 (4.1%) |
| Serratia marescens | 19 (16.1%) | 16 (84%) | 3(15.7%) | - | - |
| Pseudomonas aeruginosa | 12 (10.1%) | 4 (33.3%) | 1 (8%) | - | - |
| Enterobacter cloacae | 12 (10.1%) | 3 (25%) | - | - | - |
| Stenotrophomonas m | 8 (6.7%) | 5 (62.5%) | 2 (25%) | - | - |
| Other species | 13 (11%) | 5 (38.4%) | - | - | - |

ABBREVIATIONS. IQR: Interquartile Range. MDR: Multi-drug Resistance (resistant to at least one antibiotic in three or more antibiotic categories). ESBL: Extended spectrum beta-lactamase. BC: Blood cultures.

*Resistant to at least one antibiotic.

Conclusions/Learning Points: GNB represented an important problem in our institution, mainly related to neonatal intensive care and heart surgery. Antibiotic resistance was common. Patients that carried invasive care devices presented higher rates of bacteremia persistence and mortality.

EPIDEMIOLOGY AND CLINICAL OUTCOMES OF GRAM-NEGATIVE BLOODSTREAM INFECTIONS IN HOSPITALISED AUSTRALIAN CHILDREN

Parallel Symposium

PARALLEL SYMPOSIUM: TREATMENT OF MDR GRAM (-) INFECTIONS IN CHILDREN - PREVENTION IS BEST

Sophie Wen¹, Sonia Dougherty¹, Gabrielle Haeusler², Vanessa Clifford³, Peter Richmond⁴, Brendan McMullan⁵, Philip Britton⁶, Brian Forde⁷, Scott Beatson⁸, Henry Chambers⁹, Julia Clark¹, Luregn Schlapbach¹⁰, Patrick Harris⁷, Colleen Lau¹¹, Geoffrey Spurling¹², Luis Furuya-Kanamori⁷, Mark Chatfield⁷, David Paterson⁷, Adam Irwin¹

¹Queensland Children's Hospital, Infection Management Prevention Service, Brisbane, Australia, ²Royal Children's Hospital Melbourne, Infectious Diseases, Melbourne, Australia, ³Royal Children's Hospital Melbourne, Microbiology, Melbourne, Australia, ⁴Perth Children's Hospital, Child Health Research, Perth, Australia, ⁵Sydney Children's Hospital, Infectious Diseases, Randwick, Australia, ⁶The Children's Hospital at Westmead, Department Of Infectious Diseases And Microbiology, Westmead, Australia, ⁷University of Queensland, Centre For Clinical Research, Brisbane, Australia, ⁸University of Queensland, School Of Chemistry, Brisbane, Australia, ⁹University of California, San Francisco, Division Of Infectious Diseases, San Francisco, United States of America, ¹⁰University Children's Hospital Zurich, Pediatrics, Zurich, Switzerland, ¹¹University of Queensland, School Of Public Health, Brisbane, Australia, ¹²University of Queensland, General Practice Clinical Unit, Brisbane, Australia

Backgrounds: Gram-negative bloodstream infections (GNBSI) in children are of increasing concern, being associated with significant mortality and antimicrobial resistance. There are few population-based data to describe the risk factors and clinical outcomes from GNBSI in children. We established a surveillance study of GNBSI through the Australian Paediatric Active Enhanced Disease Surveillance (PAEDS) network. Here are the findings from the first 2 years (2019-2020).

Methods: Active surveillance commenced in five Australian tertiary paediatric hospitals in January 2019. Patients aged <18 years with a pathogenic Gram-negative organism in blood culture and suspicion of systemic infection were included. Clinical features, risk factors, antimicrobial therapy and outcomes including length of hospital and intensive care unit (ICU) stay, 30-day and in-hospital mortality, and complications associated with hospitalisation were recorded.

Results: From January 2019 to December 2020, there were 639 episodes of GNBSIs in 565 children, and 679 isolates identified. The median age was 2.9 years (IQR 0.5-7.7 years) and 59% were male. 53% were community onset and 72% occurred in children with comorbidities. Malignancy was the most common comorbidity (36%). Intravascular device was the source for 26%. Microbiology is shown in Figure 1. 13% were already in ICU at time of GNBSI onset with an additional 13% requiring ICU admission. Median duration of hospitalisation was 14 days (IQR 8-35 days). There were 42 deaths from all causes (7%) during admission, with GNBSI contributory to 60% of deaths. Nine deaths occurred within 30-days (1.4%), with no significant differences in those with/without comorbidities (1.3% vs 1.8% p-value=0.71).

Gram-negative isolates by site

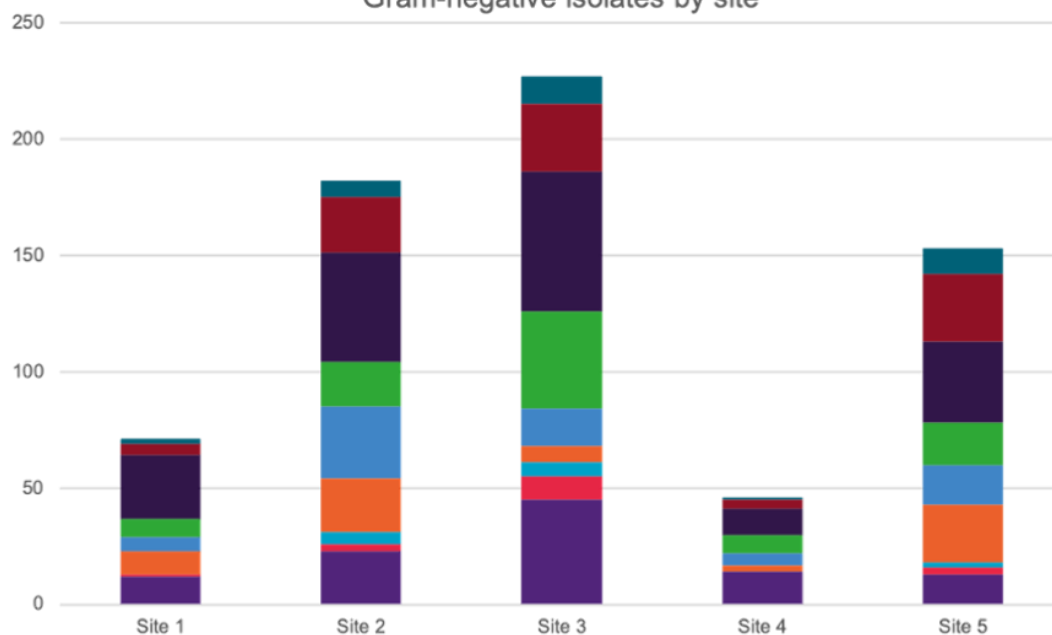

| | Site 1 | Site 2 | Site 3 | Site 4 | Site 5 |
|------------------------------|--------|--------|--------|--------|--------|
| Total | 71 | 182 | 227 | 46 | 153 |
| Acinetobacter spp | 2 | 7 | 12 | 1 | 11 |
| Enterobacter spp | 5 | 24 | 29 | 4 | 29 |
| E.coli | 27 | 47 | 60 | 11 | 35 |
| Klebsiella spp | 8 | 19 | 42 | 8 | 18 |
| Pseudomonas | 6 | 31 | 16 | 5 | 17 |
| Salmonella spp | 10 | 23 | 7 | 3 | 25 |
| Serratia marcescens | 0 | 5 | 6 | 0 | 2 |
| Stenotrophomonas Maltophilia | 1 | 3 | 10 | 0 | 3 |
| Other | 12 | 23 | 45 | 14 | 13 |

■ Other
 ■ Stenotrophomonas Maltophilia
 ■ Serratia marcescens
 ■ Salmonella spp
 ■ Pseudomonas
 ■ Klebsiella spp
 ■ E.coli
 ■ Enterobacter spp
 ■ Acinetobacter spp

Conclusions/Learning Points: GNBSI in children are associated with significant mortality and over half are healthcare associated, with a notable proportion requiring ICU admission.

ADENOVIRUS INFECTION IN IMMUNOCOMPROMISED PAEDIATRIC PATIENTS: TREATMENT AND OUTCOME.

Parallel Symposium

PARALLEL SYMPOSIUM: INFECTIONS IN IMMUNOCOMPROMISED HOSTS

Eines Monteagudo¹, Carlos Grasa¹, Maria Elena Perez¹, Iker Falces¹, Yasmina Mozo², Cristina Schüffelmann³, Teresa Del Rosal¹, Ana Méndez-Echevarría¹, Fernando Baquero-Artiago¹, Cristina Calvo¹
¹Hospital Universitario La Paz, Paediatric Infectious Diseases Unit, Department Of Paediatrics, Madrid, Spain, ²Hospital Universitario La Paz, Unidad De Hemato-oncología Infantil, Madrid, Spain, ³Hospital Universitario la Paz, Paediatric Intensive Care Unit, Madrid, Spain

Backgrounds: Human adenovirus (hAdV) infection constitutes an important cause of morbidity and mortality in immunocompromised patients as solid organ transplant (SOT) and hematopoietic stem cell transplant (HSCT) recipients. Cidofovir is the most prescribed treatment even though its use is controversial specially in asymptomatic patients. Strategies like reducing immunosuppression, or lymphocyte infusions have not yet been well described. This study aims to describe the impact and therapeutic management of hAdV infection in immunocompromised patients

Methods: Retrospective study examining episodes of positive hAdV viremia (>1.000 copies/mL) in immunocompromised hosts during a four-year follow-up (2017-2021) at a reference centre. Demographic, clinical, epidemiological, and microbiological data, lymphocyte count, therapeutic management, and outcome were collected and analysed.

Results: 49 immunosuppressed patients (median age 9 years; interquartile range IQR 1.0-16.0) were included. Main causes of immunosuppression were HSCT (38/49: 77.6%), hematologic malignancies (30/49; 61.2%), and SOT (11/49: 22.4%). 25 patients (51%) were symptomatic (mainly febrile syndrome and diarrhoea). Thirteen patients (26.5%) presented a viral coinfection with CMV or BK virus. Cidofovir was prescribed in 24 patients (49%). Other therapeutic measures included administration of intravenous immunoglobulins (18.4%), reducing immunosuppression (14.3%) and memory T-cell infusion (12.2%). Cidofovir use was significantly ($p<0.05$) associated with presence of hAdV symptoms, lower lymphocyte count, ICU admission and high viral load (Table 1). Despite treatment, 11 patients (45.8%) presented persistent positive viremias (associated with lower lymphocyte count $p<0.05$) and three patients died because hAdV infection (acute liver failure, septic shock).

| Clinical presentation symptoms during maximum hAdV viremia | Paediatric patients (n = 49) n (%) | |
|--|--|------------------------|
| <i>Febrile syndrome</i> | 16 (32.7%) | |
| <i>Diarrhoea</i> | 9 (18.4%) | |
| <i>Respiratory distress</i> | 8 (16.3%) | |
| Cidofovir use | OR (95% CI) | Overall p value |
| <i>hAdV symptoms</i> | 4.857 (1.43 – 16.49) | 0.020 |
| <i>ICU admission</i> | 1.41 (1.09-1.82) | 0.004 |
| <i>Peak viremia > 10e5 hAdV copies/ml</i> | 5.278 (1.53 – 18.15) | 0.010 |
| Resolution of infection | OR (95% CI) | Overall p value |
| <i>30-days survival</i> | 21.6 (3.38 – 137.87) | 0.001 |
| <i>60-days survival</i> | 19.92 (3.50 – 113.30) | <0.001 |
| Lymphocyte count during 1 st positive viremia | Median (s.d) | Overall p value |
| <i>Cidofovir use</i> | 622.90 (1470.65) | 0.030 |
| <i>No Cidofovir treatment</i> | 1780.80 (2102.09) | |
| <i>Resolution of infection</i> | 1440.53 (2084.90) | 0.002 |
| <i>Persistence of infection</i> | 300.00 (505.23) | |

Conclusions/Learning Points: hAdV infections had high morbidity and mortality in our series. Patients with low lymphocyte count are at higher risk of persistent positive viremias and short-term survival. We did not observe a clear association between resolution of infection and Cidofovir use.

OP008 / #861

RISK FACTORS OF CYTOMEGALOVIRUS INFECTION AFTER PEDIATRIC LIVER TRANSPLANTATION AND EFFECTIVENESS OF PREEMPTIVE THERAPY

Parallel Symposium

PARALLEL SYMPOSIUM: INFECTIONS IN IMMUNOCOMPROMISED HOSTS

Nopparak Chanburanavah¹, Sophida Boonsathorn², Nopporn Apiwattanaku², Chatmanee Lertudomphonwanit², Pornthep Tanpowpong², Songpon Getsuwan², Oraluck Pattanaprateep², Suporn Treepongkaruna²

¹Ramathibodi Hospital Mahidol University, Pediatrics, Bangkok, Thailand, ²Faculty of Medicine Ramathibohi Hospital, Department Of Pediatrics, Bangkok, Thailand

Backgrounds: Cytomegalovirus (CMV) infection is the most common viral infection after liver transplantation (LT). Preemptive therapy (PET) is an alternate approach in which antiviral therapy is initiated for early asymptomatic CMV viremia. However, the optimal viral load (VL) cut-off for initiating PET remains controversial. Therefore, this study aimed to evaluate the incidence of CMV infection, risk factors, and outcomes of PET after using different VL cut-offs in pediatric LT.

Methods: We retrospectively reviewed 126 patients aged 0-18 years who underwent LT between March 2011 and August 2020. CMV viremia was regularly monitored using quantitative nucleic acid amplification in all patients. Data on clinical characteristics and potential risk factors, including CMV serostatus, acute cellular rejection (ACR), and immunosuppressive drugs were collected. CMV infection and diseases were defined according to International guidelines. Additionally, clinical outcomes for starting PET at low VL cut-off (< 2000 copies/mL) and high VL cut-off (\geq 2000 copies/mL) were compared.

Results: In total, 90 of 126 patients (71%) developed CMV infection with a median onset of 30.2 days (Interquartile range (IQR) 13, 39). In a univariate analysis, factors associated with CMV infection included younger age, CMV D+/R-, ACR, and higher corticosteroid dosage. Only corticosteroid dosage remained associated with CMV infection in a multivariate analysis [adjusted odds ratio (OR) 116.9; 95% confidence interval (CI) 17.75-770.98; $p < 0.001$]. Recurrent CMV infection, CMV diseases, ACR, and Epstein-Barr Virus infection did not differ significantly between the low and the high VL cut-off groups.

Conclusions/Learning Points: The incidence of CMV infection was high in pediatric LT. Higher corticosteroid dosage was associated with CMV infection. Additionally, using CMV VL cut-off at 2000 copies/mL for initiating antiviral therapy seems to be a practical and effective strategy to prevent CMV diseases.

OP009 / #1491

EPIDEMIOLOGY OF EPSTEIN-BARR VIRUS (EBV) IN PEDIATRIC SOLID ORGAN TRANSPLANT RECIPIENTS (SOTR) AT TEXAS CHILDREN'S HOSPITAL (TCH)

Parallel Symposium

PARALLEL SYMPOSIUM: INFECTIONS IN IMMUNOCOMPROMISED HOSTS

Kristen Valencia Deray¹, Kathleen Hosek², Flor Munoz¹, Elizabeth Moulton¹, Claire Bocchini¹

¹Baylor College of Medicine, Pediatrics, Houston, United States of America, ²Texas Children's Hospital, Quality, Houston, United States of America

Backgrounds: Epstein-Barr virus (EBV) infections cause significant morbidity and mortality in pediatric SOTR. Post-transplant lymphoproliferative disorder is a devastating complication of EBV infection in SOTR. Contemporary data on rates of EBV DNAemia and subsequent PTLD in pediatric SOTR are limited.

Methods: A retrospective cohort study of patients ≤ 21 years of age who received lung, heart, liver, kidney, or multi-organ transplants at TCH between 2010-2018 was completed. Primary outcome was quantifiable EBV DNAemia. Associations with EBV DNAemia were measured using Fisher exact test and multivariate logistic regression. Survival analysis and time to EBV DNAemia were assessed using Kaplan-Meier method.

Results: Among 687 SOTR, 43% (295) had quantifiable EBV DNAemia; this included 45% (39/87) lung, 62% (161/259) liver, 39% (59/152) heart, 64% (9/14) multi-organ, and 15% (27/175) kidney recipients. Median time to quantifiable DNAemia for patients that developed EBV was 573 (0 – 3237) days (Figure 1). High-risk EBV status (D+/R-) [OR 2.76, 95% CI (1.6 – 4.7), and having a liver transplant [10.84 (6.4 – 18.4)] were associated with the development of EBV DNAemia. DNAemia was not associated with sex, ethnicity, or era of transplantation. Induction therapy was collinear with organ transplanted and could not be assessed. There was no difference in survival during the study follow-up period (1–9 years) for SOTR with vs. without DNAemia ($p=0.08$). Overall PTLD occurred in 4% (26/687) of SOTR; this included 6% (5/87) lung, 2% (6/259) liver, 8% (12/152) heart, 0% (0/14) multiorgan, and 2% (3/175) kidney recipients.

Time to EBV DNAemia by Organ Transplanted with 95% Confidence Limits

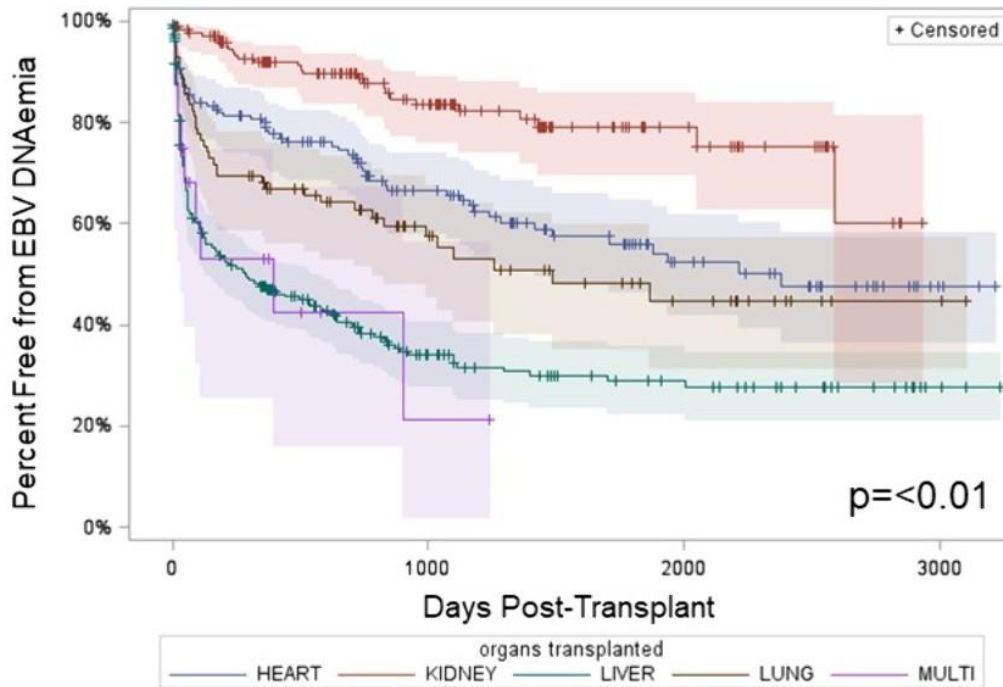

Conclusions/Learning Points: This large contemporary cohort of pediatric SOTR demonstrates high overall rates of EBV DNAemia and relatively low rates of PTLD. Heart SOTR had the highest rate of PTLD, suggesting that further interventions targeting this group may be warranted.

OP010 / #611

RECURRENT TB IN A COHORT WITH SUSPECTED PULMONARY TB: A DESCRIPTIVE RETROSPECTIVE COHORT STUDY

Parallel Symposium

PARALLEL SYMPOSIUM: PEDIATRIC TUBERCULOSIS TREATMENT

Carla Mckenzie¹, Marieke M Van Der Zalm¹, Rolanda Croucamp¹, Elisabetta Walters^{1,2}

¹Stellenbosch University, Desmond Tutu Tb Centre, Department Of Paediatrics And Child Health, Cape Town, South Africa, ²Great North Children's Hospital, Paediatrics, Newcastle upon Tyne, United Kingdom

Backgrounds: In adults, there is a high risk of recurrent TB after successful treatment, however limited data is available in children. The aim of this study was to determine burden and risk factors of TB recurrence in children.

Methods: Retrospective descriptive study of TB recurrence in children aged 0-13 years presenting with presumptive pulmonary TB in Cape Town, South Africa from March 2012 to November 2017. Recurrent TB is defined as >1 episode TB treatment (both confirmed or clinically diagnosed disease).

Results: Data of 608 children were reviewed for TB recurrence, the median age was 16.7 months (interquartile range, IQR: 9.5-33.3), 324 male (53.3%) and 72 living with HIV (LHIV, 11.8%). A total of 52/608 (8.4%) of all children had reported previous treatment for TB. Of these, 28 were treated again as TB cases, and 2 were excluded due to misdiagnosis of TB at previous episode. Recurrent TB was thus seen in 26/281 (9.3%) of current TB cases. 8/26 (30.8%) of children had the same TB contact as the previous episode. Current TB episode was confirmed in 11/26 (42.3%) with median time-lapsed since previous episode of 21 months (IQR: 16.3-45). Underlying comorbidities were seen in 19/26 (73.1%) of the children, all HIV infected and some with malnutrition (8/26) and chronic lung disease (3/26). Two thirds of children LHIV reported poor adherence to antiretrovirals (84.2%) and low CD4 counts.

Conclusions/Learning Points: Recurrent TB was common in this young cohort of children with PTB. Children LHIV are at significantly higher risk for recurrent TB. More data is needed to identify other risk factors for recurrent TB and long-term follow up for repeated recurrence and post TB lung disease.

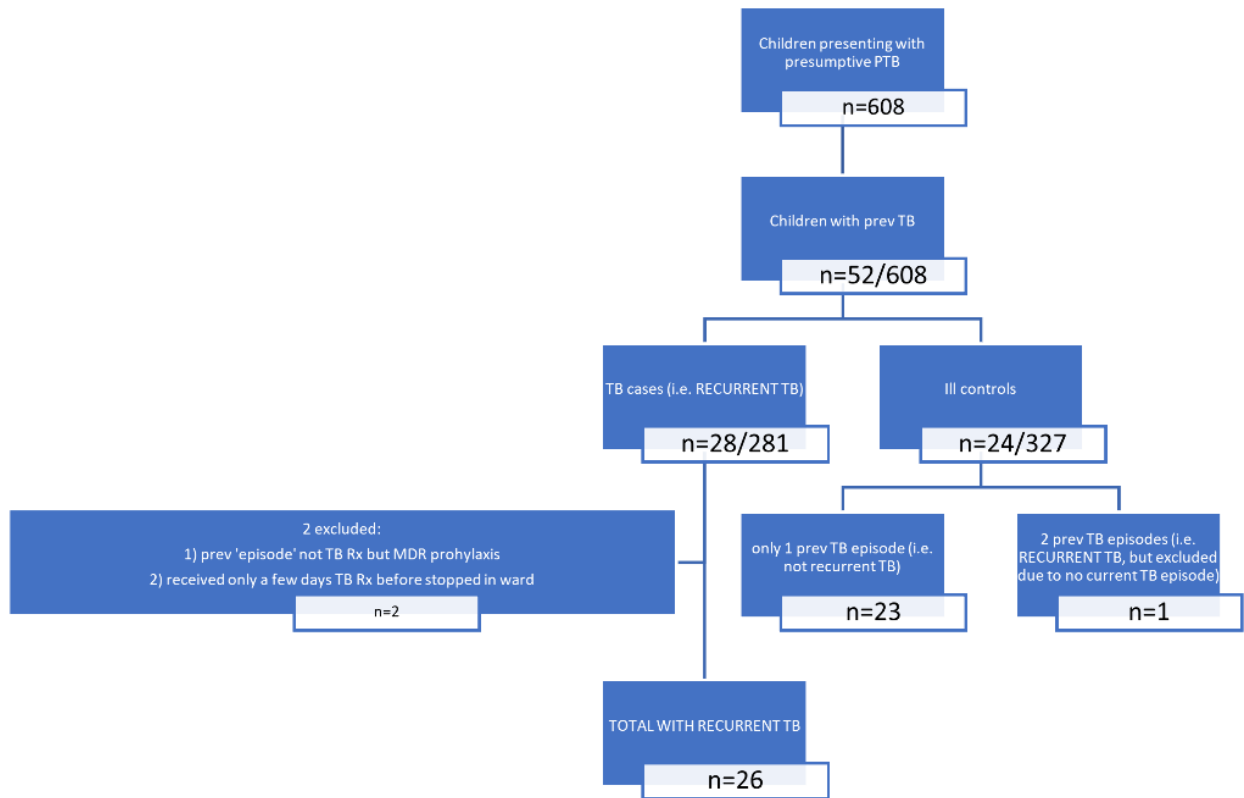

Figure 1: Identification of children with recurrent TB

EFFECTS OF COVID-19 PANDEMIC ON TUBERCULOSIS INFECTION RATES IN CAMPANIA REGION: DECREASE IN NOTIFICATION AND INCREASE IN CLINICAL SEVERITY

Parallel Symposium

PARALLEL SYMPOSIUM: PEDIATRIC TUBERCULOSIS TREATMENT

Chiara Amato, Sara Maria Scarano, Federica Pagano, Alfonso Maria Farina, Rita Nunziata, Alfredo Guarino, Andrea Lo Vecchio
 University of Naples, Federico II, Department Of Translational Medical Sciences - Section Of Pediatrics, Naples, Italy

Backgrounds: Before the COVID-19 pandemic, we described an increase in tuberculosis (TB) notification rates at the Campania Region’s paediatric Reference Centre (CRRC). Since 2020, we observed a reduction in the incidence of TB, hence, we decided to compare TB incidence rates and disease severity in the period 2020-2021 to 2011-2019.

Methods: We conducted a prospective cohort study (Jan 1st 2011 to Dec 31st 2021) enrolling children <18 years who received diagnosis of TB at the CRRC. Yearly TB incidence rates were calculated dividing the number of new cases with the number of residents < 18 years in Campania. Disease severity was based on the need of oxygen support and the score proposed by Wiseman et al. according to localization (pulmonary and extrapulmonary) and/or cavitation.

Results: Overall 154 children (48.1% male, median age 63 months, IQR 101.76) received diagnosis of TB, 142 in the period 2011-2019 with a significant increase in notification rates overtime (Fig). In 2020-2021, 12 new diagnoses were notified with a drop from 1.46/100.000 (95%CI, 0.84-2.37) in 2019 to 0.38 (95%CI, 0.1-0.96) in 2021. Two (17%) needed oxygen support. The number of cases classified as severe according to clinical score, was higher in the period 2020-2021 (5/12, 42%) compared with 2011-2019 (22/142, 15%), with 2/12 (17%) extrapulmonary and 2/12 (17%) cavitation.

TB rate / 100 000 inhabitants < 18 years

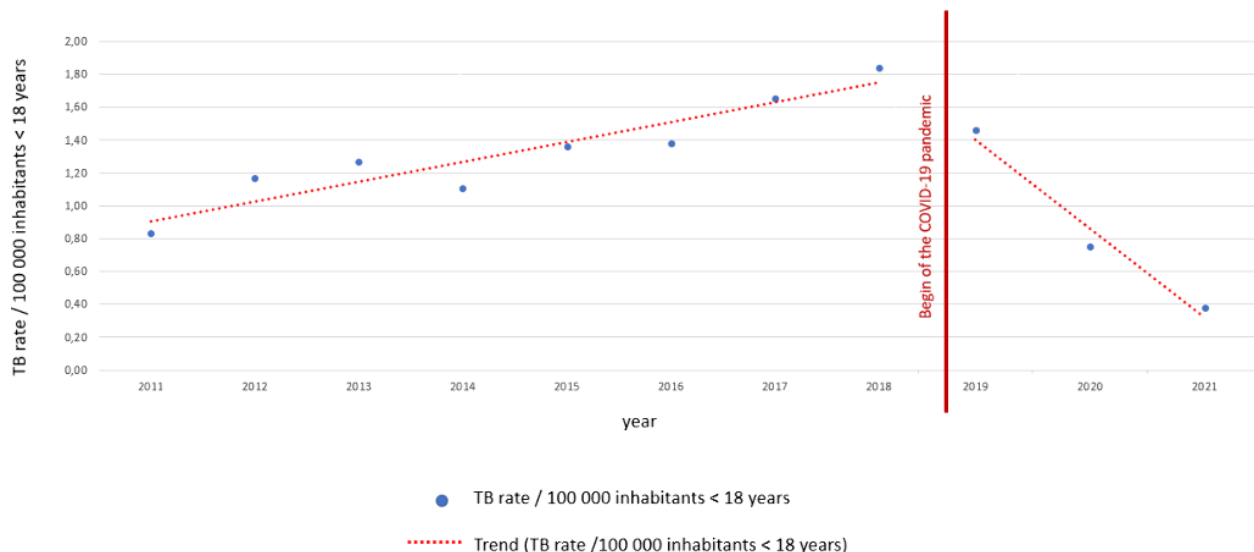

Conclusions/Learning Points: During 2020-2021 the CRRC registered a decrease in TB notification rates and an increase in the severity of the disease, compared with 2011-2019. The Stop TB Partnership suggested that COVID-19 could cause an excess of TB cases globally between 2020 and 2025. That rebound, in Campania, has not yet occurred likely because of the shift in medical attention from TB and the reallocation of human resources towards the pandemic effort.

THE T-CELL ACTIVATION MARKER FOR TB (TAM-TB) IN “RAPAED-TB”- A NEW DIAGNOSTIC TOOL FOR PAEDIATRIC TB

Parallel Symposium

PARALLEL SYMPOSIUM: PEDIATRIC TUBERCULOSIS TREATMENT

Laura Olbrich^{1,2}, Heather Zar³, Issa Sabi⁴, Nyanda Ntinginya⁴, Celso Khosa⁵, Denise Banze⁵, Marriott Nliwasa⁶, Elizabeth Corbett⁷, Robina Semphere⁶, Valsan Verghese⁸, Joy S Michael⁹, Stephen Graham¹⁰, Rinn Song¹¹, Pamela Nabeta¹², Andre Trollip¹², Mohammed Ahmed¹, Kathrin Held¹, Michael Hoelscher¹, Christof Geldmacher¹, Norbert Heinrich¹³

¹Ludwig-Maximilians University, Division Of Infectious Diseases And Tropical Medicine, University Hospital, Munich, Germany, ²University of Oxford, Oxford, Oxford Vaccine Group, Department Of Paediatrics, Oxford, United Kingdom, ³University of Cape Town, Sa-mrc Unit On Child And Adolescent Health, Cape Town, South Africa, ⁴Mbeya Medical Research Centre, National Institute For Medical Research -, Mbeya, Tanzania, ⁵Instituto Nacional de Saúde (INS), Instituto Nacional De Saúde, Marracuene, Mozambique, ⁶College of Medicine, Tb/hiv Research Group, Blantyre, Malawi, ⁷London School of Hygiene and Tropical Medicine, Tb Centre, London, United Kingdom, ⁸Christian Medical College (CMC), Pediatric Infectious Diseases, Department Of Pediatrics, Vellore, India, ⁹Christian Medical College (CMC), Department Of Clinical Microbiology, Vellore, India, ¹⁰University of Melbourne, Centre For International Child Health, Melbourne, Australia, ¹¹Oxford Vaccine Group, University of Oxford, Oxford, UK, Department Of Paediatrics, Oxford, United Kingdom, ¹²Foundation for Innovative New Diagnostics, Foundation For Innovative New Diagnostics, Geneva, Switzerland, ¹³Division of Infectious Diseases and Tropical Medicine, University Hospital, Lmu, Munich, Germany

Backgrounds: The diagnosis of tuberculosis (TB) in children remains the biggest hurdle in overcoming the epidemic. The blood-based T cell marker for TB assay (TAM TB) characterizes TB-specific CD4+ T cells based on the expression of surface markers. This approach allows a differentiation between latently and actively infected TB patients.

Methods: RaPaed-TB is a diagnostic validation study conducted in five countries enrolling children suspected of having TB. Alongside a thorough clinical and microbiological workup, a number of new tests are being evaluated including the TAM TB. The latter is a flow-cytometry based assay using a standardized kit which gives a result within 16-24h. Data cleaning is underway; presented data are preliminary and totals differ.

Results: In total, 974 participants were enrolled with an overall microbiological confirmation rate (PCR/culture) of 24.2% (236/974), sufficient information for clinical case definition was available for 732 children. Overall, more than 890 TAM TBs were performed at enrolment. Using culture as reference standard, early analyses show a modest sensitivity of 60.8% (95%CI 48.8-72.0) and specificity of 83.5% (95%CI 77.0-88.9) in the overall cohort, with superior performance in children <1 year with a sensitivity of 80.0% (95%CI 51.9-95.7) and specificity of 85.0% (95%CI 62.1-96.8). Logistic regression was performed to explore determinants of TAM TB accuracy, generating strong evidence of TST-positivity increasing the odds for true-positivity in reference standard positive children by 5.06 (95%CI 1.83-13.99, p=0.0018). Further analyses are ongoing, and results are to be presented.

Conclusions/Learning Points: RaPaed-TB is one of the largest TB diagnostic validation studies comparing several new tests ever performed in children. Presented data indicate a promising performance of TAM-TB, especially in the very young children.

OP013 / #1083

PROGNOSTIC ACCURACY OF AGE-ADAPTED ORGAN DYSFUNCTION SCORES FOR IN-PATIENT MORTALITY AND DEVELOPMENT OF MODS IN CHILDREN ADMITTED TO PAEDIATRIC INTENSIVE CARE

Parallel Symposium

PARALLEL SYMPOSIUM: MANAGEMENT OF FEVER

Abbey Bracken, Shane D'Souza, Honor Boyle, Enitan Carrol
University of Liverpool, Institute Of Infection, Veterinary And Ecological Sciences Liverpool, Liverpool, United Kingdom

Backgrounds: The sepsis-3 definitions were developed from databases of adult patients and were neither designed nor validated in children. We sought to validate the performance of age-adapted PMODS, qSOFA, PELOD-2 and SIRS in predicting outcomes for children consecutively admitted to a Paediatric Intensive Care Unit (PICU). Design: Prospective, observational study. Setting: A single-centre regional PICU in the United Kingdom. Patients: 656 consecutively admitted children under the age of 16 years were enrolled.

Methods: All children were categorised based on the Sepsis-3 definitions: sepsis, septic shock and no infection. Biochemical and physical parameters were measured within the first 24 hours of PICU admission. The primary outcomes were a composite outcome of 28-day mortality and PICU LOS>3 days, and development of multi-organ dysfunction syndrome (MODS). We derived scores for age-adapted PMODS, qSOFA, PELOD-2 and SIRS in predicting the primary outcomes. The performance of the scores were evaluated using area under the curve (AUC).

Results: Median age was 1.02 years (IQR 0.29 – 5.02). 367 were post-operative cardiac surgical patients (56%), 105 other surgical (16%), and 184 non-surgical (28%). 351 infectious episodes were described. In all patients, SIRS was positive in 39.8% of episodes (n=261). 10.5% of children developed DIC (n=69). 123 developed MODS, and D28 mortality was 1.8%. PMODS gave the best discrimination for predicting mortality or LOS, and MODS, in the sepsis and septic shock subgroups. Mortality or LOS>3; sepsis: 0.50 (0.38 – 0.62) and septic shock: 0.67 (0.39 – 0.95) MODS; sepsis: 0.62 (0.49 – 0.75) and septic shock: 0.75 (0.45 – 1.00).

Conclusions/Learning Points: When using Sepsis-3 criteria, PMODS provides excellent prediction of both in-hospital mortality or PICU length of stay over 3 days, and development of MODS in children with septic shock.

GUIDELINE ADHERENCE IN FEBRILE CHILDREN BELOW THREE MONTHS VISITING EUROPEAN EMERGENCY DEPARTMENTS: AN OBSERVATIONAL MULTICENTER STUDY

Parallel Symposium

PARALLEL SYMPOSIUM: MANAGEMENT OF FEVER

Chantal Tan¹, Eline Van Der Walle¹, Clementien Vermont², Ulrich Von Both³, Enitan Carrol^{4,5}, Marieke Emonts^{6,7}, Michiel Van Der Flier^{8,9}, Ronald De Groot⁸, Jethro Herberg¹⁰, Benno Kohlmaier¹¹, Michael Levin¹², Emma Lim^{6,7}, Ian Maconochie¹³, Federico Martín-Torres^{14,15}, Ruud Nijman¹⁰, Marko Pokorn¹⁶, Irene Rivero-Calle^{14,15}, Maria Tsolia¹⁷, Shunmay Yeung¹⁸, Werner Zenz¹¹, Dace Zavadska¹⁹, Henriette Moll¹

¹Erasmus Medical Center - Sophia Children's Hospital, General Pediatrics, Rotterdam, Netherlands, ²Erasmus MC-Sophia Children's Hospital, Department Of Paediatric Infectious Diseases And Immunology, Rotterdam, Netherlands, ³Dr. von Hauner, Division Of Paediatric Infectious Diseases, Munchen, Germany, ⁴University of Liverpool, Institute Of Infection, Veterinary And Ecological Sciences Liverpool, Liverpool, United Kingdom, ⁵Alder Hey Children's NHS Foundation Trust, Alder Hey Children's Nhs Foundation Trust, Liverpool, United Kingdom, ⁶Great North Children's Hospital, Paediatric Immunology, Infectious Diseases And Allergy, Newcastle upon Tyne, United Kingdom, ⁷Newcastle University, Translational And Clinical Research Institute, Newcastle upon Tyne, United Kingdom, ⁸Amalia Children's Hospital, Paediatric Infectious Diseases And Immunology, Nijmegen, Netherlands, ⁹Wilhelmina Children's Hospital, 12. paediatric Infectious Diseases And Immunology, Utrecht, Netherlands, ¹⁰Imperial College London, Section Of Paediatric Infectious Diseases, London, United Kingdom, ¹¹Medical University of Graz, Department Of General Paediatrics, Graz, Austria, ¹²Imperial College London, Department Of Infectious Disease, London, United Kingdom, ¹³Imperial College Healthcare Trust NHS, Paediatric Emergency Medicine, London, United Kingdom, ¹⁴Hospital Clínico Universitario de Santiago de Compostela, Translational Paediatrics And Infectious Diseases, Paediatrics Department, Santiago de Compostela, Spain, ¹⁵University of Santiago de Compostela, Genetics, Vaccines And Paediatrics Research Group, Santiago de Compostela, Spain, ¹⁶University Medical Centre Ljubljana, Department Of Infectious Diseases And Faculty Of Medicine, Ljubljana, Slovenia, ¹⁷National and Kapodistrian University of Athens, Second Department Of Pediatrics, "p. & A. Kyriakou" Children's Hospital, Athens, Greece, ¹⁸London School of Hygiene and Tropical Medicine, Faculty Of Tropical And Infectious Diseases, London, United Kingdom, ¹⁹Children's Clinical University Hospital, Department Of Paediatrics, Riga, Latvia

Backgrounds: Febrile children below three months have a higher risk of serious bacterial infections, which often leads to extensive diagnostics and treatment. However, there is practice variation in management due to differences in guidelines and the usage and adherence. We aimed to assess whether management in febrile children below three months attending European Emergency Departments (EDs) was according to the available guidelines for fever.

Methods: This study is part of the MOFICHE study, which is an observational multicenter study including routine data of febrile children (0-18 years) attending twelve European EDs. In febrile children <3 months (excluding bronchiolitis), we analyzed actual management compared to the available guidelines for fever. Ten EDs applied the (adapted) NICE guideline and two EDs applied local guidelines. Management included diagnostic tests, antibiotic treatment and admission. Subgroup analyses in children <1 month and 1-3 months were performed. Data on follow-up was not collected.

Results: We included 913 children (median age 1.7 months) with the majority triaged as intermediate/high urgent (53%), 40% having a respiratory tract infection and 56% having a viral illness. Management per ED varied: diagnostic tests 14-83%, antibiotic treatment 23-54%, admission 34-86%. Adherence to the guidelines varied: blood cultures were obtained in 43% (374/868), lumbar punctures in 30% (144/488), antibiotics were prescribed in 55% (270/492) and 67% (573/859) were admitted. Full adherence to all these four components occurred in 15% (132/868, range 0-38%), 31% (71/223) in children <1 month and 10% (61/645) in children 1-3 months respectively.

Conclusions/Learning Points: There is large practice variation in management and guideline adherence

was limited, but highest for admission which implies good safety netting. Future studies should focus on guideline revision with new biomarkers in order to optimize management in young febrile children.

OP015 / #437

VALIDATION OF TRANSCRIPTOMIC SIGNATURES FOR FEBRILE CHILDREN USING NANOSTRING TECHNOLOGY AND EXPLORATION OF MULTI-CLASS PREDICTION MODELS

Parallel Symposium

PARALLEL SYMPOSIUM: MANAGEMENT OF FEVER

Samuel Channon-Wells, Dominic Habgood-Coote, Victoria Wright, Michael Levin, Myrsini Kaforou, Jethro Herberg

Imperial College London, Department Of Infectious Disease, London, United Kingdom

Backgrounds: Many host transcript signatures for paediatric inflammatory and infectious diseases are in development, but require validation in independent cohorts; their translation to clinically useful test platforms lags behind discovery. We used NanoString technology to efficiently validate multiple signatures in parallel and explore the potential for more sophisticated multi-class classification models.

Methods: We validated five transcriptomic diagnostic signatures using prospectively recruited patients from multiple paediatric cohorts. Final phenotypes were assigned using pre-agreed definitions after review of clinical and laboratory data. We quantified 69 transcripts on a custom NanoString nCounter cartridge, normalising expression values using reference genes. Signature performance was assessed using Area Under ROC Curve (AUC) statistics. We explored two approaches to multiclassification diagnostics to develop proof-of-concept methods: a mixed test combining four independent one-vs-all models, and a multinomial model.

Results: Our cohort of 92 paediatric patients included 23 definite bacterial and 20 definite viral infections, 15 Kawasaki disease, 18 with tuberculosis and 16 healthy controls. The signatures achieved AUCs above 0.82 (Table 1), with confidence intervals overlapping those of the respective discovery studies. However, performance declined in all signatures when tasked with differentiating additional groups. For example, the single-transcript BATF2 had AUC of 0.910 differentiating TB from healthy individuals, reducing to 0.745 when differentiating TB from other febrile diseases. In comparison, the multinomial approach identified a 24-transcript model that correctly classified all 76 non-control patients (0% in-sample error), outperforming the mixed-model (19 transcripts, 19.8% in-sample error).

Table 1: Diagnostic accuracy statistics for primary comparisons of each signature. Sensitivity and specificity were optimised to the combination that maximises Youden's J statistic. AUC, Area Under ROC Curve; CI, Confidence Interval; KD, Kawasaki Disease. DB, Definite Bacterial infection; DV, Definite Viral infection; TB, Tuberculosis disease; DRS, Disease Risk Score.

| | AUC [95% CI] | SENSITIVITY [95% CI] | SPECIFICITY [95% CI] |
|--|-----------------------|-----------------------|-----------------------|
| Wright 13-transcript KD signature DRS: | | | |
| KD vs other diseases | 0.885 [0.808 - 0.963] | 0.933 [0.681 - 0.998] | 0.721 [0.592 - 0.829] |
| Herberg 2-transcript DB/DV signature DRS: | | | |
| DB vs DV | 0.825 [0.691 - 0.959] | 0.739 [0.516 - 0.898] | 0.950 [0.751 - 0.999] |
| DB vs other diseases | 0.694 [0.551 - 0.837] | 0.739 [0.516 - 0.898] | 0.755 [0.617 - 0.862] |
| DV vs other diseases | 0.846 [0.742 - 0.949] | 0.900 [0.683 - 0.988] | 0.768 [0.636 - 0.870] |
| Pennisi 2-transcript DB/DV signature DRS: | | | |
| DB vs DV | 0.867 [0.753 - 0.982] | 0.783 [0.563 - 0.925] | 0.900 [0.683 - 0.988] |
| DB vs other diseases | 0.696 [0.568 - 0.825] | 0.696 [0.471 - 0.868] | 0.698 [0.557 - 0.817] |
| DV vs other diseases | 0.865 [0.756 - 0.974] | 0.900 [0.683 - 0.988] | 0.786 [0.656 - 0.884] |
| TB3 3-transcript TB signature DRS: | | | |
| TB vs other diseases | 0.884 [0.791 - 0.977] | 0.833 [0.586 - 0.964] | 0.810 [0.686 - 0.901] |
| BATF2 single-transcript signature: | | | |
| TB vs healthy controls | 0.910 [0.808 - 1.000] | 0.833 [0.586 - 0.964] | 0.938 [0.698 - 0.998] |
| TB vs other diseases | 0.745 [0.623 - 0.868] | 0.556 [0.308 - 0.785] | 0.865 [0.765 - 0.933] |

Conclusions/Learning Points: The cross-platform, out-of-sample findings validated 5 signatures, but discriminatory power was reduced in patients drawn from outside their remit. An exploratory 24-transcript model had improved accuracy across all diagnostic groups, demonstrating in principle the utility for one-step multi-class diagnosis in patients with broad diagnostic uncertainty.

BIRC6 MODIFIES RISK OF INVASIVE BACTERIAL INFECTION IN KENYAN CHILDREN.

Parallel Symposium

PARALLEL SYMPOSIUM: MANAGEMENT OF FEVER

James Gilchrist¹, Silvia Kariuki², James Watson³, Gavin Band⁴, Sophie Uyoga², Carolyn Ndila², Neema Mturi², Salim Mwarumba², Shebe Mohammed², Moses Mosobo², Kirk Rockett⁴, Alexander Mentzer⁴, Dominic Kwiatkowski⁴, Adrian Hill⁴, Anthony Scott², Thomas Williams²

¹University of Oxford, Department Of Paediatrics, Oxford, United Kingdom, ²KEMRI-Wellcome Trust Research Programme, Centre For Geographic Medicine Research-coast, Kilifi, Kenya, ³University of Oxford, Centre For Tropical Medicine And Global Health, Oxford, United Kingdom, ⁴Wellcome Centre for Human Genetics, University Of Oxford, Oxford, United Kingdom

Backgrounds: Invasive bacterial disease is a major cause of morbidity and mortality in African children. Here we leverage cases of bacterial sepsis among children diagnosed with severe malaria to augment study power in a genome-wide association study (GWAS) of invasive bacterial disease in Kenyan children.

Methods: We performed a GWAS of invasive bacterial infection in Kenyan children (n=5,482: 1,445 bacteraemia cases, 1,143 severe malaria cases, 2,894 controls). To account for the varying probability of invasive bacterial disease among malaria cases, we used probabilistic models to identify children with a high probability of culture-negative bacterial sepsis, applying these probabilities as weights for malaria cases in our analysis. We replicated our findings in a second sample collection (n=1,692: 434 bacteraemia cases, 1,258 controls).

Results: In children with a clinical diagnosis of severe malaria, 31.1% have a low ($P(\text{SM}|\text{Data}) < 0.5$) probability of their disease being 'true' severe malaria. These children are critically unwell (case fatality=14.5%) and are enriched for bacteraemia (OR=3.06, $p=1.07 \times 10^{-4}$). We thus hypothesised that a substantial proportion of these children have bacterial sepsis. By including these children in a weighted logistic regression GWAS, we identify and validate rs183868412 as a risk locus for invasive bacterial infection in Kenyan children: $\text{OR}_{\text{disc}}=2.14$, $P_{\text{disc}}=4.02 \times 10^{-9}$; $\text{OR}_{\text{rep}}=2.77$, $P_{\text{rep}}=1.29 \times 10^{-3}$; $\text{OR}_{\text{meta}}=2.22$, $P_{\text{meta}}=1.66 \times 10^{-11}$. This locus is a determinant of BIRC6 splicing in stimulated monocytes ($\text{PP}_{\text{coloc}}=0.94$).

Conclusions/Learning Points: Here we identify children with a high likelihood of invasive bacterial disease among critically unwell Kenyan children with malaria. By including these children in a GWAS of invasive bacterial infection we identify and validate a novel risk locus for invasive bacterial disease. The trait-associated variation modifies splicing of BIRC6 in stimulated monocytes, implicating the regulation of apoptosis and autophagy in the pathogenesis of sepsis in African children.

HIGH PREVALENCE OF MYCOPLASMA PNEUMONIAE CARRIAGE IN CHILDREN WITH RECURRENT RESPIRATORY TRACT INFECTIONS IS ASSOCIATED WITH AN ENRICHMENT OF H.INFLUENZAE

Parallel Symposium

PARALLEL SYMPOSIUM: MICROBIOME IN HEALTH AND DISEASE

Mischa Koenen^{1,2}, Ruben De Groot³, Wouter De Steenhuijsen Piters^{2,4,5}, Ad De Bruijn³, Mei Ling Chu^{2,5}, Erhard Van Der Vries⁶, Marianne Boes^{1,2}, Debby Bogaert^{2,4}, Annemarie Van Rossum⁷, Wendy Unger³, Lilly Verhagen^{2,8}

¹UMC Utrecht, Center Of Translational Immunology, Utrecht, Netherlands, ²Wilhelmina Children's hospital (part of UMC Utrecht), Department Of Pediatric Infectious Diseases And Immunology, Utrecht, Netherlands, ³Erasmus MC (University Medical Center Rotterdam), Laboratory Of Pediatrics, Division Of Pediatric Infectious Diseases And Immunology, Rotterdam, Netherlands, ⁴Queen's Medical Research Institute, University of Edinburgh, Center For Inflammation Research, Edinburgh, United Kingdom, ⁵National Institute for Public Health and the Environment, Centre For Infectious Disease Control, Bilthoven, Netherlands, ⁶GD Animal Health, Department Of Research & Development, Deventer, Netherlands, ⁷Erasmus MC (University Medical Center Rotterdam), Department Of Pediatrics, Division Of Pediatric Infectious Diseases And Immunology, Rotterdam, Netherlands, ⁸Radboud UMC Amalia Children's Hospital, Department Of Pediatric Infectious Diseases And Immunology, Nijmegen, Netherlands

Backgrounds: Recurrent respiratory tract infections (rRTI) affect up to 10% of young children and cause considerable morbidity. Mycoplasma pneumoniae is a common bacterial cause of lower respiratory tract infection in children and often preceded by asymptomatic upper respiratory tract carriage. We hypothesize that M. pneumoniae carriage is impacted by the local respiratory microbiota and therefore studied this relationship in the context of the mucosal immune system.

Methods: From March 2016 till December 2019 children <7 years with rRTI were included in a prospective cohort study (DIMER study). We studied nasopharyngeal microbiota using 16S-rRNA-sequencing and performed qPCR to detect M. pneumoniae carriage. Furthermore, we analyzed M. pneumoniae-specific and total IgA levels in nasopharyngeal swabs.

Results: We included 117 children suffering from rRTI of whom 53% had an antibody deficiency: IgA deficiency (25%), IgG subclass deficiency (15%) or a combination of both (14%). In this pediatric cohort we observed a very high carriage of M. pneumoniae of 68% carried in the upper respiratory tract. Mucosal M. pneumoniae-specific and total IgA levels were similar between M. pneumoniae carriers and non-carriers. However, we observed that M. pneumoniae carriers had lower microbiota alpha diversity when compared to non-carriers (median Shannon index 1.1 [IQR 0.8-1.4] vs. 1.4 [IQR 1.0-1.7], p=0.003. In multivariable logistic regression analysis corrected for multiple confounders (age, RTI symptoms during sampling, antibiotic prophylactic treatment), a strong association was found between Haemophilus influenzae/haemolyticus and M. pneumoniae carriage (OR 23.33 [1.63-751.43], p=0.04, Figure 1).

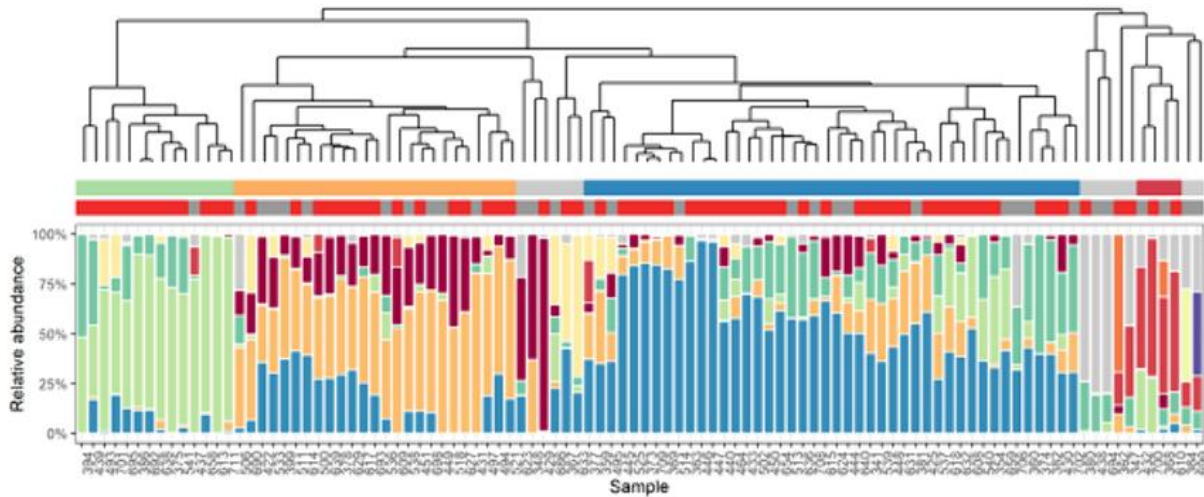

| Multivariable analysis | OR [95% CI] | p-value |
|--|--------------------------------------|-------------|
| Age in years | 1.01 [0.74-1.40] | 0.95 |
| RTI symptoms present at sample collection | 0.53 [0.17-1.57] | 0.26 |
| Sample collected in winter | 3.19 [0.64-26.56] | 0.20 |
| Antibiotic prophylaxis within 3 months of sampling | 0.96 [0.18-5.59] | 0.96 |
| Total mucosal sIgA levels | 0.68 [0.23-1.88] | 0.45 |
| Alpha diversity (Shannon index) | 0.48 [0.14-1.54] | 0.24 |
| Relative abundance <i>Moraxella catarrhalis</i> | 8.43 [0.85-101.43] | 0.08 |
| Relative abundance <i>Haemophilus influenzae /haemolyticus</i> | 23.33 [1.63-751.43] | 0.04 |

Conclusions/Learning Points: *M. pneumoniae* carriage was highly prevalent in children with rRTI. *M. pneumoniae* carriers had an altered nasopharyngeal microbiota, characterized by an enrichment of *H. influenzae/haemolyticus*.

THE RELATIONSHIP BETWEEN PEDIATRIC GUT MICROBIOTA AND SARS-COV-2 INFECTION

Parallel Symposium

PARALLEL SYMPOSIUM: MICROBIOME IN HEALTH AND DISEASE

Lorenza Romani¹, Gabriele Macari², Stefania Pane³, Maria Vittoria Ristori⁴, Valerio Guarrasi², Simone Gardini², Giuseppe Rubens Pascucci⁵, Federica Del Chierico⁶, Nicola Cotugno⁷, Stefania Bernardi¹, Andrea Campana⁸, Alberto Villani⁹, Paolo Rossi¹⁰, Carlo Federico Perno¹¹, Team Cactus Study¹², Paolo Palma⁷, Lorenza Putignani¹³

¹Bambino Gesù Children's Hospital, IRCCS, Immunology An Infectious Diseases Unit, Rome, Italy, ²GenomeUp SRL, Viale Pasteur, 6, Genomeup Srl, Viale Pasteur, 6, Rome, Italy, ³Bambino Gesù Children's Hospital, IRCCS, Department Of Diagnostic And Laboratory Medicine, Unit Of Microbiology And Diagnostic Immunology, Unit Of Microbiomics, Rome, Italy, ⁴Bambino Gesù Children's Hospital, IRCCS, Multimodal Laboratory Medicine Research Area, Unit Of Human Microbiome, Rome, Italy, ⁵Bambino Gesù Children's Hospital, IRCCS, Research Unit Of Congenital And Perinatal Infections, Rome, Italy, ⁶Bambino Gesù Children's Hospital, IRCCS, 4multimodal Laboratory Medicine Research Area, Unit Of Human Microbiome, Rome, Italy, ⁷Bambino Gesù Children Hospital, Clinical Immunology And Vaccinology Research Unit, Rome, Italy, ⁸Bambino Gesù Children's Hospital, IRCCS, Department Of Paediatrics, Rome, Italy, ⁹Bambino Gesù Children's Hospital, IRCCS, Pediatric Emergency Department And General Pediatrics, Rome, Italy, ¹⁰Bambino Gesù Children's Hospital, IRCCS, Academic Department Of Paediatrics, Rome, Italy, ¹¹Bambino Gesù Children's Hospital, IRCCS, Department Of Diagnostic And Laboratory Medicine, Unit Of Microbiology And Diagnostic Immunology, Multimodal Laboratory Medicine Research Area, Rome, Italy, ¹²Bambino Gesù Children's Hospital, IRCCS, Bambino Gesù Children's Hospital, Rome, Italy, ¹³Bambino Gesù Children's Hospital, IRCCS, Department Of Diagnostic And Laboratory Medicine, Unit Of Microbiology And Diagnostic Immunology, Unit Of Microbiomics And Multimodal Laboratory Medicine Research Area, Unit Of Human Microbiome, Rome, Italy

Backgrounds: The effect of SARS-CoV-2 on altering the gut microbiome have been investigated since the beginning of the pandemic. To our knowledge, this is the first observational cohort study on the correlations between gut microbiota (GM) and COVID-19 infection in children.

Methods: The GM profile was investigated by 16S rRNA targeted-metagenomics to analyze ecology and inferred functions of COVID-19 patients compared to healthy subjects (CTRLs). Multiple machine learning (ML) models were exploited. Correlation between ASVs abundances and inflammatory protein levels was investigated using R software.

Results: The GM in COVID-19 patients (N=67) was characterized by reduction of alfa-diversity compared to CTRLs ($p < 0.05$). In the GM of COVID-19 children an increase of Faecalibacterium, Fusobacterium, Neisseria and decrease of Bifidobacterium, Blautia, Ruminococcus, Collinsella, Coprococcus, Eggerthella, Akkermansia were reported, compared to CTRLs (FDR<0.05). ML models for GM biomarker prediction in COVID-19 patients, compared to CTRLs, identified: Actinomyces, Alistipes, Faecalibacterium, Anaerostipes, Phascolarctobacterium, Dorea, Clostridium, Prevotella, Oscillospira, Staphylococcus, Rominococcus. The KO-based prediction of GM functional profile of COVID-19, compared to CTRLs, highlighted lipopolysaccharide and peptidoglycan biosynthesis, amino acids biosynthesis, alanine, aspartate and glutamate metabolism specifically associated to COVID-19 patients; while PPAR signaling pathway; ether lipid metabolism; fatty acid degradation; valine, leucine and isoleucine degradation to CTRLs subjects. A statistically significant positive correlation between Bacteroidetes and pro-inflammatory cytokines (e.g., ITGA11, CLECA4 and DNER) was observed.

Conclusions/Learning Points: Our study provides a specific characterization of the GM of pediatric COVID-19. Unlike adult, high levels of Faecalibacterium were reported as a specific treat of the COVID-19 in children. GM profile and intrinsic GM anti-inflammatory and fermentative properties may play a central role in the low severity of COVID-19 in children.

POLYREACTIVE MUCOSAL ANTIBODIES AND H. INFLUENZAE/HAEMOLYTICUS ARE ASSOCIATED WITH RESPIRATORY TRACT INFECTION SEVERITY IN YOUNG CHILDREN SUFFERING FROM RECURRENT INFECTIONS

Parallel Symposium

PARALLEL SYMPOSIUM: MICROBIOME IN HEALTH AND DISEASE

Mischa Koenen^{1,2}, Wouter De Steenhuijsen Piters^{2,3,4}, Roosmarijn Van Der Woude⁵, Robert De Vries⁵, Debby Bogaert^{2,3}, Marianne Boes^{1,2}, Erhard Van Der Vries⁶, Lilly Verhagen^{2,7}

¹UMC Utrecht, Center Of Translational Immunology, Utrecht, Netherlands, ²Wilhelmina Children's hospital (part of UMC Utrecht), Department Of Pediatric Infectious Diseases And Immunology, Utrecht, Netherlands, ³Queen's Medical Research Institute, University of Edinburgh, Center For Inflammation Research, Edinburgh, United Kingdom, ⁴National Institute for Public Health and the Environment, Centre For Infectious Disease Control, Bilthoven, Netherlands, ⁵University Utrecht, Department Of Chemical Biology & Drug Discovery, Utrecht Institute For Pharmaceutical Sciences, Utrecht, Netherlands, ⁶GD Animal Health, Department Of Research & Development, Deventer, Netherlands, ⁷Radboud UMC Amalia Children's Hospital, Department Of Pediatric Infectious Diseases And Immunology, Nijmegen, Netherlands

Backgrounds: Recurrent respiratory tract infections (rRTI) are commonly seen in young children. In clinical care trajectories, the immunological defence against respiratory pathogens is gauged by measuring antibody levels in serum, even though the infection usually remains limited to the respiratory mucosa. We aim to clarify the role of mucosal antibodies and their interplay with the respiratory microbiome in RTI susceptibility.

Methods: Serum, saliva and nasopharyngeal samples from 85 children <7 years with rRTIs and their family members were collected in a prospective cohort study between 2016-2019 (DIMER study). ELISA was used to determine the level and reactivity of mucosal antibodies. Polyreactive antibodies were defined as a high correlation in antibody levels across four different respiratory viruses. The nasopharynx was sampled at 3 consecutive time points at the beginning of winter. In these samples, respiratory microbiome composition was determined by 16S-rRNA-sequencing and respiratory viruses were detected by qPCR. RTI symptoms were monitored using a daily mobile phone application.

Results: Around 25% of secretory IgA (sIgA) in saliva was found to be polyreactive (Spearman rho >0.95, p<0.001). Levels of polyreactive saliva sIgA and IgG were negatively associated with H. influenzae/haemolyticus relative abundance (linear regression β -195, p=0.023/-87.4, p=0.049). Furthermore, a high relative abundance of H. influenzae/haemolyticus was associated with more viral detection in univariable analysis. In multivariable analysis, of the interaction of polyreactive sIgA/IgG and H. influenzae/haemolyticus was strongly associated with RTI disease severity in winter (multinomial logit 21, p<0.001/10, p<0.001).

Methods

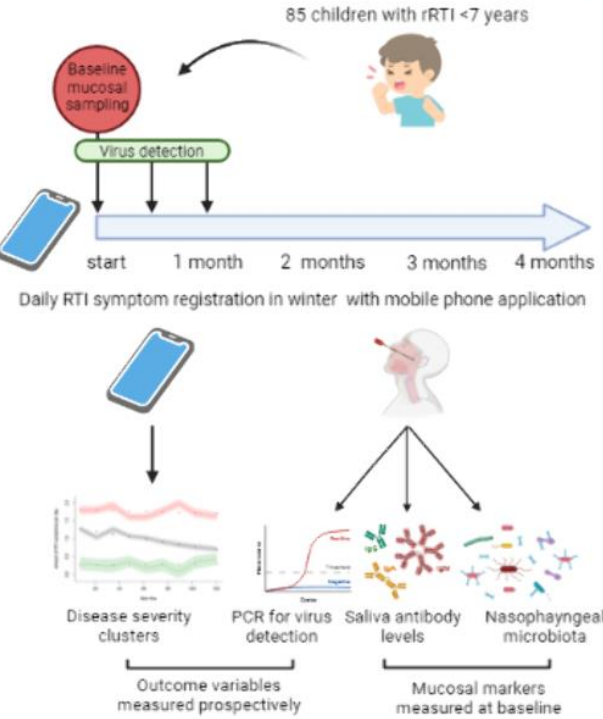

Results

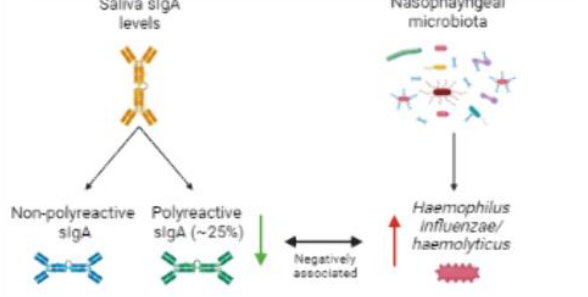

Conclusion

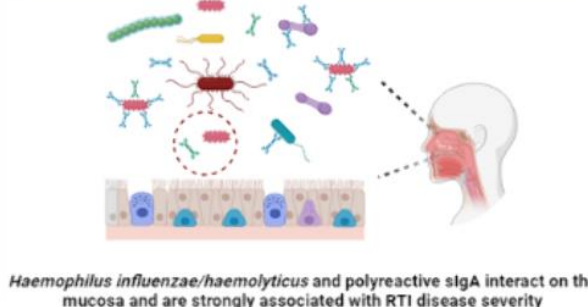

Conclusions/Learning Points: Polyreactive mucosal antibodies interact with *H. influenzae/haemolyticus* on the respiratory tract mucosa and, together, these factors are strongly associated with RTI disease severity in young children with rRTI. *H. influenzae/haemolyticus* is known to produce IgA proteases, which could explain the inverse relation with sIgA levels.

PICU ADMISSION RELATED TO SARS-COV-2 BY VACCINATION STATUS.

Parallel Symposium

PARALLEL SYMPOSIUM: PRECISION VACCINOLOGY

Michaël Levy¹, Morgan Recher², Hervé Hubert³, Julien Baleine⁴, Noémie Vanel⁵, Charlène Garbot⁶, Etienne Javouhey⁷, Pierre-Louis Léger⁸, Pierre Tissiere⁹, Sylvain Renolleau¹⁰, Francois Angoulvant¹¹, Stéphane Leteurre²

¹Robert Debré Hospital, Pediatric Intensive Care Unit, Paris, France, ²CHRU de Lille, Pediatric Intensive Care Unit, Lille, France, ³Université de Lille, Ulr2694-metrics, Lille, France, ⁴CHU de Montpellier, Pediatric Intensive Care Unit, Montpellier, France, ⁵CHU de la Timone, Pediatric Intensive Care Unit, Marseille, France, ⁶CHU de la Martinique, Pediatric Intensive Care Unit, Fort de France, France, ⁷Hopital Femme Mère Enfant, Pediatric Intensive Care Unit, Bron, France, ⁸Armand Trousseau Hospital, Pediatric Intensive Care Unit, Paris, France, ⁹Hopital Bicêtre, Pediatric Intensive Care Unit, Kremlin Bicêtre, France, ¹⁰Hopital Nceker-Enfants Malades, Pediatric Intensive Care Unit, Paris, France, ¹¹Hôpital robert Debré, Pediatric Infectious Diseases, Paris, France

Backgrounds: COVID-19 mRNA vaccine immunogenicity and effectiveness is well established in children and adolescents. Summer and autumn 2021 in France were marked by both, waves of COVID-19 cases due to the Delta variant, and by the recommendation of the French Public Health Agency (FPHA) to vaccinate children from the age of 12 years. The aim of this national study was to estimate PICU admission related to SARS-CoV2 by vaccination status - PICURE Study

Methods: From September 1, 2021 to January 5, 2022, all pediatric patients diagnosed with MIS-C according to WHO criteria and/or a positive SARS-CoV2 PCR and admitted to the 41 French Pediatric Intensive Care Units (PICU) were prospectively included in this study. Data regarding age, gender, admission to PICU, vaccination status of patients between 12 and 18 years, hereafter referred to as adolescents, were recorded. To account for the increasing numbers of adolescents vaccinated over time including during the period, hazard ratio (HR) of unvaccinated versus vaccinated adolescents was estimated using Cox proportional hazards model.

Results: Among the 233 admitted children, 94 (40%) were females. Median age was 77 months (IQR: 7 to 138 months). Admission was related to 71(31%) acute SARS CoV-2 infection, to 109(47%) MIS-C, and 52 (22%) incidental diagnosis of SARS-CoV-2. At least one comorbidity was identified in 73 (31%) cases. Among the 55 included adolescents, 43 were not vaccinated, 5 were vaccinated against COVID-19 and the information was missing for 7 patients. The HR for PICU admission related to SARS-CoV2 was 0.04 (95% CI 0.02 to 0.10, p<.001) after COVID-19 mRNA vaccine compared with unvaccinated adolescents.

Conclusions/Learning Points: The data suggest that COVID-19 mRNA vaccine in adolescents was associated with a decrease of PICU admission related to SARS-CoV2.

MINIMIZING RISK OF MYOCARDITIS FOLLOWING COVID-19 VACCINATION THROUGH AGE PREFERENTIAL MRNA VACCINE BRAND CHOICE

Parallel Symposium

PARALLEL SYMPOSIUM: PRECISION VACCINOLOGY

Hazel Clothier^{1,2,3}, Emma Roney^{1,2}, Daryl Cheng^{1,4,5}, Hannah Morgan^{1,2}, Jim Buttery^{2,4}

¹Murdoch Children's Research Institute, Saefvic, Infection And Immunity, Parkville, Australia, ²Melbourne Children's Campus, Centre For Health Analytics, Parkville, Australia, ³University of Melbourne, School Of Population & Global Health, Parkville, Australia, ⁴Royal Children's Hospital, Department Of General Medicine, Parkville, Australia, ⁵University of Melbourne, Department Of Paediatrics, Parkville, Australia

Backgrounds: Myocarditis has been identified as an adverse event associated with COVID-19 mRNA vaccination, with some countries implementing age-related preferential recommendations using Comirnaty (Pfizer) over Spikevax (Moderna). Australia is one of few countries administering both mRNA vaccines in young adolescents aged 12-17 year-olds, with 87% two-dose coverage of this population achieved by end of 2021.

Methods: Reports of myocarditis following immunisation submitted to Victoria's vaccine safety surveillance system, SAEFVIC, from 22 February to 31 December 2021 were compared as counts and rates by age-group, dose and mRNA vaccine brand administered. Cases were confirmed using Brighton Collaboration criteria, with those meeting level 1 and level 2 clinical confidence included in analyses. Rates per 100,000 doses administered were estimated according to the Australian Immunisation Registry (AIR), and 90% Poisson confidence intervals calculated.

Results: 185 reports of myocarditis (162 following Comirnaty, 23 post Spikevax) were reported following almost 7 million doses of mRNA vaccines administered (6,572,861 Comirnaty, 376,151 Spikevax), a rate of 2.7 per 100,000 doses. The myocarditis reporting rate following Spikevax was more than double that of Comirnaty (6.1 vs 2.5 per 100,000, $p < 0.001$) and for each dose (Table 1). For both vaccines, the highest reporting rates were observed for 16-17 year-old males following dose 2 (29.0 per 100,000 mRNA second doses), with a reduction in the incidence of cases for the 12-15 and 18-24 age groups.

Table 1: Myocarditis reports as rate per 100,000 doses administered, by vaccine brand and dose

| mRNA vaccine brand | Count, rate per 100,000 (90%CI) | | | | |
|--------------------|---------------------------------|------------------------|--------|-------------------------|---------------------------|
| | Dose 1 | | Dose 2 | | Total |
| Comirnaty | 43 | 1.3 (1.0, 1.7) | 120 | 3.7 (3.2, 4.3) | 162 2.5 (2.2, 2.8) |
| Spikevax | 7 | 3.6 (1.7, 6.8)* | 16 | 8.7 (5.5, 13.3)* | 23 6.1 (4.2, 8.7)* |
| Total | 50 | 1.4 (1.1, 1.8) | 136 | 4.0 (3.4, 4.6) | 185 2.7 (2.4, 3.0) |

*Bold = statistically significant brand difference

Conclusions/Learning Points: Even in adolescents, the risk-benefit equation remains in favour of vaccination, especially given the risk of myocarditis following COVID-19 disease. Australia has the luxury of two available efficacious and safe mRNA vaccines. Mitigating the risk of this rare adverse event via preferential age recommendations in the highest risk adolescent age-group is an option.

SARS-COV-2 INFECTION IN CHILDREN YOUNGER THAN 5 YEARS ACCORDING TO PARENT'S VACCINATION STATUS

Parallel Symposium

PARALLEL SYMPOSIUM: PRECISION VACCINOLOGY

Michaël Levy¹, Naim Ouldali², Pierre Mornand³, Paul Casha⁴, Fouad Madhi⁵, Alexis Rybak², Robert Cohen², Vincent Gajdos⁶, Camille Aupiais⁷, Manon Passard⁸, Noémie Vanel⁹, Irina Craiu¹⁰, Corinne Levy², Francois Angoulvant¹¹

¹Robert Debré Hospital, Pediatric Intensive Care Unit, Paris, France, ²ACTIV, Paediatrics, Créteil, France, ³CH Annecy, Pediatric Department, Annecy, France, ⁴CH de Toulon, Pediatric Department, Toulon, France, ⁵CHI de Creteil, Pediatric Department, Créteil, France, ⁶Hôpital antoine Béclère, Pediatric Department, Clamart, France, ⁷Hopital Jean Verdier, Paediatrics, Bondy, France, ⁸Hopital Femme Mère Enfant, Pediatric Department, Bron, France, ⁹CHU de la Timone, Pediatric Intensive Care Unit, Marseille, France, ¹⁰Hôpital Universitaire Bicêtre, APHP, Pediatric Emergency, Kremlin-Bicêtre, France, ¹¹Hopital universitaire Robert Debré, Pediatric Infectious Diseases And Internal Medicine, Paris, France

Backgrounds: COVID-19 mRNA vaccine immunogenicity and effectiveness are well established in adolescents and children over 5 years of age. To date, COVID-19 mRNA vaccines are not licensed for younger children. The aim of this study was to estimate incidence of SARS-CoV-2 infection in children younger than 5 by parents COVID-19 vaccination status from the start of the general vaccination for all adults.

Methods: In this French national prospective surveillance, 66 pediatric departments enrolled children hospitalized with SARS-CoV-2 infection and/or or Multisystem Inflammatory Syndrome in Children (MIS-C). All children younger than 5 years admitted from 12/05/21 to 21/12/2021 with available data regarding parent's vaccination status were included. To account for the increasing numbers of vaccinated parents over time including during the period in which cases were measured, hazard ratio (HR) of unvaccinated versus vaccinated parents was estimated using Cox proportional hazards model.

Results: From 12/05/2021 to 21/12/2021, the number of French adults, 18 to 59 years, fully vaccinated rose from 7% to 90%. Among the 214 enrolled children, 164 (77%) were younger than 5 years, and parent's vaccination was available for 81 (38%). Overall, 61 children with available parent's vaccination status were included with 33 (65%) younger than 3 months, 7 (14%) aged from 3 to <12 months, and 11 (22%) aged from 12 to <60 months. Among them, 10 had at least one parent vaccinated, and 51 had none of their parents vaccinated. The HR for COVID-19 infection in children younger than 5 years was 0.03 (95% CI 0.02 to 0.07, p<.001) with vaccinated parents compared with unvaccinated.

Conclusions/Learning Points: Parent's COVID-19 vaccination was associated with a dramatic decrease risk of admission related to COVID-19 infection in children younger than 5.

DESIGN AND IMPLEMENTATION OF A BREATH-RATE MEASUREMENT SOLUTION BASED ON COMPUTER VISION AND MACHINE LEARNING TECHNIQUES IN CHILDREN WITH LOWER RESPIRATORY INFECTION

Parallel Symposium

PARALLEL SYMPOSIUM: ARTIFICIAL INTELLIGENCE IN PEDIATRIC DIAGNOSIS

Serena Villaverde¹, Marcos Sánchez², Julián Cabrera², Jesús Gutiérrez², Isabel Rodríguez², Angela Manzanares¹, Ana De La Rocha³, Ignacio Garrido³, Lola Madrid⁴, Pablo Rojo¹
¹HOSPITAL 12 DE OCTUBRE, Paediatrics, MADRID, Spain, ²UNIVERSIDAD POLITÉCNICA DE MADRID, Information Processing And Telecommunications Center And Etsi Telecomunicación, Madrid, Spain, ³UNIVERSIDAD COMPLUTENSE DE MADRID, Facultad De Medicina, Madrid, Spain, ⁴London School of Hygiene and Tropical Medicine, Department Of Infectious Disease Epidemiology, London, United Kingdom

Backgrounds: Camera-based diagnostic methods could allow an objective analysis of a patient's health remotely and contactless, which is especially interesting in telemedicine and pandemic scenarios. Artificial intelligence and computer vision can provide the diagnostic tools needed to improve patient monitoring. The main objective of this work is the design and implementation of a solution to estimate respiratory rate (RR) from a video captured through a smartphone, based on computer vision and deep learning techniques.

Methods: Prospective study of clinical information and a video of the patients' chest with and without respiratory distress under 10 years old from November 2020 to May 2021 attending for a lower respiratory infection in a tertiary hospital in Spain. Video pre-processing was carried out using computer vision methods. As an initial approximation, remote photoplethysmographic signal (rPPG) was used with subsequent processing using the Discrete Wavelet Transform (DWT) and different methods to estimate the RR.

Results: 19 patients were included and 22 video sequences were pre-processed to carry out the estimation of the respiratory rate using the PPG signal approach. 51.3% were males and the average rate age was 2 years (DE 0.32). 61.5% patients had not relevant medical records. 48.7% were diagnosed of bronchiolitis followed by 30.1% diagnosed of asthma symptoms. Results obtained by different methods to estimate the RR can be seen in Table

1.

| Method | Accuracy (%) |
|---|--------------|
| rPPG + DWT + Peak detection | 87.53 |
| rPPG + DWT + Linear Regression model | 80.10 |
| rPPG + DWT + Regression Decision Trees | 74.40 |
| rPPG + DWT + Support Vector Machine model | 77.50 |

Conclusions/Learning Points: It has been possible to design a breath-rate measurement solution to estimate RR from a video, based on DWT transformation to rPPG signal. This could be the first step in order to implement a breath-rate measurement solution based on computer vision and deep learning techniques.

PREDICTING SEVERE PNEUMONIA IN THE EMERGENCY DEPARTMENT: A GLOBAL STUDY OF THE PEDIATRIC EMERGENCY RESEARCH NETWORK (PERN)

Parallel Symposium

PARALLEL SYMPOSIUM: ARTIFICIAL INTELLIGENCE IN PEDIATRIC DIAGNOSIS

Todd Florin¹, Daniel Tancredi², Lilliam Ambroggio³, Franz Babl⁴, Stuart Dalziel⁵, Michelle Eckerle⁶, Santiago Mintegi⁷, Mark Neuman⁸, Amy Plint⁹, Jillian Benedetti¹, Norma-Jean Simon¹, Nathan Kuppermann²

¹Ann and Robert H. Lurie Children's Hospital of Chicago, Pediatrics (emergency Medicine), Chicago, United States of America, ²University of California - Davis, Emergency Medicine, Davis, United States of America, ³Children's Hospital Colorado, Pediatrics, Aurora, United States of America, ⁴Royal Children's Hospital, Paediatrics, Melbourne, Australia, ⁵University of Auckland, Paediatrics, Auckland, New Zealand, ⁶Cincinnati Children's Hospital Medical Center, Pediatric Emergency Medicine, Cincinnati, United States of America, ⁷Hospital Universitario Cruces, Pediatric Emergency Medicine, Bizkaia, Spain, ⁸Boston Children's Hospital, Pediatric Emergency Medicine, Boston, United States of America, ⁹Children's Hospital of Eastern Ontario, Paediatric Emergency Medicine, Ottawa, Canada

Backgrounds: Pneumonia is a frequent and costly cause of emergency department (ED) visits and hospitalizations in children. No validated tools exist to assist with management decisions for children presenting to the ED with community-acquired pneumonia (CAP). Our objective was to develop prediction models to accurately risk stratify children with CAP across a global network of pediatric EDs.

Methods: Prospective study of children 3 months to <14 years old with CAP at 69 EDs in the Pediatric Emergency Research Network. We excluded children with recent hospitalizations, chronic conditions, or critically ill. The primary outcome was an ordinal composite of CAP severity occurring within 7 days: mild (discharged), moderate (hospitalized but not severe), and severe (empyema/effusion requiring drainage, ICU>48 hours, respiratory failure requiring positive-pressure ventilation, septic shock, vasoactive infusions, extracorporeal membrane oxygenation, or death). Multivariable logistic regression was used to develop risk models for moderate/severe disease (vs. mild) and for severe disease (vs. mild or moderate).

Results: Of 2518 children, 1314 (52.2%) had mild CAP, 1094 (43.4%) moderate, and 110 (4.4%) severe (Table 1). Vomiting, elevated heart rate, elevated respiratory rate, oxygen saturation <90%, altered mental status, retractions, prolonged capillary refill, and pleural effusion were associated with development of moderate/severe CAP (Table 2). Elevated heart rate, asymmetric breath sounds, retractions, and pleural effusion were associated with severe CAP. The AUC for the moderate/severe model was 0.844 (95% CI, 0.828, 0.860) and for the severe model was 0.827 (95% CI, 0.792,

Table 1. Cohort Characteristics

| | Overall (n=2518) | Mild (n=1314) | Moderate (n=1094) | Severe (n=110) |
|--|-----------------------------|--------------------------|------------------------------|---------------------------|
| Age (years) | 3 [1,5] | 3 [2,6] | 2 [1,5] | 3 [1,5] |
| Female sex | 1238 (49.2) | 629 (47.9) | 555 (50.7) | 54 (49.1) |
| Prior history of pneumonia | 368 (14.6) | 184 (14) | 166 (15.2) | 18 (16.4) |
| Prior history of asthma/wheeze | 938 (37.3) | 471 (35.8) | 428 (39.1) | 39 (35.5) |
| Pneumococcal vaccination | 2180 (86.6) | 1151 (87.6) | 935 (85.5) | 94 (85.5) |
| History of Current Illness | | | | |
| Symptom duration (days) | 5 [3,7] | 5 [3,7] | 5 [3,7] | 5 [4,7] |
| Fever present | 2239 (88.9) | 1192 (90.7) | 952 (87) | 95 (86.4) |
| Fever duration (days) | 3 [1,5] | 3 [1,5] | 3 [1,5] | 4 [2,5] |
| Symptoms present | | | | |
| Cough | 2407 (95.6) | 1259 (95.8) | 1043 (95.3) | 105 (95.5) |
| Difficulty breathing/short of breath | 1460 (58) | 575 (43.8) | 798 (72.9) | 87 (79.1) |
| Vomiting | 842 (33.4) | 410 (31.2) | 390 (35.7) | 42 (38.2) |
| Decreased urine output | 662 (26.3) | 288 (21.9) | 336 (30.7) | 38 (34.6) |
| Refusal to drink (<50% usual) | 702 (27.9) | 280 (21.3) | 378 (34.6) | 44 (40) |
| Irritable | 833 (33.1) | 374 (28.5) | 411 (37.6) | 48 (43.6) |
| Antibiotics before ED visit | 652 (25.9) | 293 (22.3) | 324 (29.6) | 35 (31.8) |
| Physical Examination in the ED | | | | |
| Temperature °C | 37.6 [36.9, 38.5] | 37.5 [36.9, 38.5] | 37.6 [37, 38.5] | 37.6 [37, 38.5] |
| Respiratory rate (highest) | 38 [30, 48] | 32 [26, 40] | 44 [36, 54] | 48 [40, 57] |
| Heart rate (highest) | 147 [129, 165] | 137 [120, 156] | 155 [139, 170] | 160 [143, 176] |
| Systolic blood pressure | 106 [98, 115] | 107 [99, 115] | 106 [97, 115] | 105 [97, 114] |
| Oxygen saturation (lowest) | 95 [92, 97] | 96 [95, 98] | 92 [89, 95] | 91 [88, 95] |
| Altered mental status | 113 (4.5) | 11 (0.8) | 90 (8.2) | 12 (10.9) |
| Capillary refill >= 3 seconds | 87 (3.5) | 24 (1.8) | 57 (5.2) | 6 (5.5) |
| Retractions | 963 (38.2) | 249 (18.6) | 639 (58.4) | 75 (68.2) |
| Wheezing | 575 (22.9) | 206 (15.7) | 330 (30.2) | 39 (35.5) |
| Unilateral | 113 (19.7) | 62 (30.1) | 42 (12.7) | 9 (23.1) |
| Bilateral | 458 (79.7) | 142 (68.9) | 288 (87.3) | 28 (71.8) |
| Rales | 1366 (54.2) | 687 (52.3) | 626 (57.2) | 53 (48.2) |
| Unilateral | 905 (66.3) | 535 (77.9) | 338 (54) | 32 (60.4) |
| Bilateral | 461 (33.7) | 152 (22.1) | 288 (46) | 21 (39.6) |
| Asymmetric breath sounds | 1126 (44.7) | 548 (41.7) | 510 (46.6) | 68 (61.8) |
| Decreased breath sounds | 1166 (46.3) | 517 (39.4) | 580 (53) | 69 (62.7) |
| Abdominal tenderness | 156 (6.2) | 75 (5.7) | 73 (6.7) | 8 (7.3) |
| Chest Radiograph Performed* | n=2263 | n=1123 | n=1037 | n=103 |
| Chest radiograph interpretation | | | | |
| No atelectasis or consolidation | 554 (24.5) | 273 (24.3) | 252 (24.3) | 29 (28.2) |
| Favoring atelectasis | 72 (3.2) | 39 (3.5) | 30 (2.9) | 3 (2.9) |
| Atelectasis vs consolidation | 223 (9.9) | 118 (10.6) | 98 (9.5) | 7 (6.8) |
| Favoring consolidation | 1414 (62.5) | 693 (61.7) | 657 (63.4) | 64 (62.1) |
| Focality (if findings present) | | | | |
| Unifocal | 1060 (75.1) | 571 (82.6) | 456 (69.4) | 33 (51.6) |
| Multifocal | 352 (24.9) | 120 (17.4) | 201 (30.6) | 31 (48.4) |
| Hyperinflation present | 533 (23.6) | 267 (23.8) | 245 (23.6) | 21 (20.4) |
| Pleural effusion present | 208 (9.2) | 72 (6.4) | 103 (9.9) | 33 (32) |

*Chest radiographs performed in 2263 patients. Denominator of results is in patients who had chest radiography performed.

0.862).

Table 2. Multivariable Risk Prediction Models for Pediatric CAP. The first model predicts moderate or severe CAP vs. mild CAP, indicating patients for whom hospitalization should be considered. The second model predicts severe CAP vs. mild or moderate CAP, indicating patients for whom intensive care may be warranted. Both models are adjusted for global region (North America, Central/South America, Europe, Asia, or Australia/New Zealand). Asterisk indicates values where $p < 0.05$.

| Predictor | Moderate or Severe Disease [adjusted OR (95% confidence interval)] | Severe Disease [adjusted OR (95% confidence interval)] |
|---|--|--|
| History | | |
| History of pneumonia | 0.88 (0.65, 1.2) | 0.98 (0.55, 1.76) |
| Smoke exposure | 0.84 (0.62, 1.15) | 0.78 (0.4, 1.5) |
| Fever | 0.95 (0.66, 1.36) | 1.15 (0.6, 2.2) |
| Vomiting | 1.43 (1.15, 1.8)* | 1.22 (0.79, 1.89) |
| Physical Examination | | |
| Temperature (per °C) | 0.96 (0.86, 1.06) | 0.93 (0.75, 1.15) |
| Heart rate >95 th %ile | 1.58 (1.22, 2.04)* | 2.37 (1.5, 3.76)* |
| Respiratory rate >95 th %ile | 2.33 (1.85, 2.93)* | 1.65 (0.94, 2.9) |
| Hypoxia (oxygen saturation <90%) | 6.78 (4.46, 10.31)* | 1.59 (0.96, 2.63) |
| Altered mental status | 3.03 (1.31, 7.0)* | 1.23 (0.6, 2.52) |
| Rales | | |
| None | REF | REF |
| Unilateral | 0.64 (0.5, 0.81) | 0.68 (0.41, 1.12) |
| Bilateral | 1.1 (0.81, 1.5) | 0.61 (0.35, 1.08) |
| Asymmetric breath sounds | 1.21 (0.97, 1.52) | 1.76 (1.13, 2.75)* |
| Retractions | 2.99 (2.36, 3.78)* | 1.97 (1.2, 3.25)* |
| Capillary refill 3+ seconds | 2.37 (1.31, 4.28)* | 1.47 (0.58, 3.73) |
| Chest Radiography | | |
| Pleural effusion on CXR | 2.17 (1.47, 3.22)* | 5.58 (3.33, 9.33)* |

Conclusions/Learning Points: We prospectively derived risk prediction models for pediatric CAP with features easily available at ED presentation in a global cohort of pediatric EDs. Both demonstrated excellent ability to predict moderate/severe disease warranting hospitalization, and severe disease for which intensive care should be considered.

OP025 / #723

INVASIVE MOLD INFECTIONS IN CHRONIC GRANULOMATOUS DISEASE: A SINGLE-CENTER RETROSPECTIVE COHORT

Parallel Symposium

PARALLEL SYMPOSIUM: FUNGAL INFECTIONS IN PAEDIATRICS

Zeynep Ergenç¹, Sevgi Eltan², Elif Aydın², Safa Baris², Ahmet Ozen², Sevgi Aslan¹, Seyhan Yılmaz¹, Burcu Parlak¹, Eda Kepenekli¹

¹Marmara University School of Medicine, Pediatric Infectious Diseases, Istanbul, Turkey, ²Marmara University School of Medicine, Pediatric Immunology And Allergy, Istanbul, Turkey

Backgrounds: Invasive fungal infections are an important cause of mortality in patients with chronic granulomatous disease (CGD). In this study, we aimed to determine the incidence and the prognosis of invasive mold infections in CGD cases followed in our center.

Methods: All CGD cases followed up in the Marmara University School of Medicine, Division of Pediatric Immunology, between 2007 and 2021 were included. Demographic and clinical characteristics, primary antifungal prophylaxis regimen, and if mold-associated invasive fungal infection (mIFI) is seen, the type, treatment, prognosis, and secondary prophylaxis regimen used for mIFI were analyzed retrospectively.

Results: Thirty-one patients with CGD were included. All patients were diagnosed with CGD via the DihydroRodamin test. Twenty-five (80.6%) patients were male. CGD was X-linked in 13 patients and autosomal recessive in 14 patients. The median age at diagnosis of CGD was 51.6 (min:2, max:302) months. Allogeneic hematopoietic stem cell transplantation was performed in 5 patients. Fifteen mIFI attacks were detected in 14 of 31 patients. The type of mIFI was proven in 4, probable in 2, and possible in 8 patients. Median mIFI age was 94.7 (min:3, max:331) months. A total of 3 patients died, two of them were due to mIFI. Of those with mIFI, 5 (35.8%) were autosomal recessive and 9 (64.2%) were X-linked. Ten patients were diagnosed with CGD while investigating the mIFI episode, and mIFI was detected in the other four patients under itraconazole prophylaxis.

Conclusions/Learning Points: In this study, we revealed the overburden of mIFI in our CGD cases. A prophylaxis regimen with an agent with better mold activity can be considered as a measure to reduce the burden of mIFI. The second phase of this study continues on a multicenter basis, as the experience of a single center is insufficient to make this recommendation.

ANTIFUNGAL USE IN EUROPEAN PEDIATRIC INTENSIVE CARE UNITS (PICUS): A 12-WEEK MULTICENTER MODIFIED POINT PREVALENCE STUDY (CALYPSO)

Parallel Symposium

PARALLEL SYMPOSIUM: FUNGAL INFECTIONS IN PAEDIATRICS

Elisavet Chorafa¹, Elias Iosifidis¹, Andrea Oletto², Adilia Warris³, Elio Castagnola³, Roger Bruggemann³, Andreas Groll³, Thomas Lehrnbecher³, Laura Ferreras Antolin³, Alessio Mesini³, Emmanuel Roilides¹, Calypso Calypso Study Group¹

¹Aristotle University of Thessaloniki, Infectious Diseases Unit, 3rd Pediatric Department, Thessaloniki, Greece, ²Fondazione, Penta Onlus, Padova, Italy, ³European Pediatric Mycology Network, Epmyrn, Thessaloniki, Greece

Backgrounds: Knowledge of antifungal use in PICUs across Europe, while frequently prescribed, is limited. A 12-wk modified point-prevalence study was conducted to record antifungal use in European PICUs.

Methods: All patients hospitalized in the participating PICUs and receiving systemic antifungals were included. Information about ward demographics was collected once at the beginning; weekly ward and patient data were collected prospectively for the 12-wk study period and entered in REDCap database.

Results:

Table 1. Antifungal agents used for treatment and prophylaxis.

| Antifungal agent | Treatment, N=63 | | | Prophylaxis N=38 (n, %) |
|------------------------------|-----------------------------|-----------------------------|----------------------------|-------------------------------|
| | Empirical N=36 (n, %) | Preemptive N=8 (n, %) | Targeted N=19 (n, %) | |
| Fluconazole | 19 (53%) | 1 (13%) | 5 (26%) | 17 (45%) |
| Isavuconazole | 0 | 1 (13%) | 0 | 0 |
| Voriconazole | 0 | 2 (25%) | 0 | 2 (5%) |
| Posaconazole | 0 | 0 | 0 | 1 (3%) |
| LAMB | 9 (25%) | 2 (25%) | 7 (37%) | 4 (11%) |
| ABLC | 0 | 1 (13%) | 1 (5%) | 1 (3%) |
| Caspofungin | 1 (3%) | 1 (13%) | 2 (11%) | 4 (11%) |
| Micafungin | 6 (17%) | 0 | 2 (11%) | 6 (16%) |
| Anidulafungin | 1 (3%) | 0 | 0 | 3 (8%) |
| Combination of 2 antifungals | 0 | 0 | 2 (11%) | 0 |

18 PICUs (15 hospitals), in 10 European countries participated. 8/18 (44%) of PICUs followed prophylactic practices for patients with immunocompromise/neutropenia, long-term parenteral nutrition or central lines, 7/18 (39%) had an antifungal stewardship program implemented and the majority (16/18) used biomarkers (15/16 galactomannan, 12/16 each beta-D-glucan and Cryptococcal antigen). 101 patients with ages ≤ 90 d (14 patients), 3-60mo (44pts) and >5 yr (43pts) were recorded. Malignancy was the most common underlying condition among patients aged >90 d (28%) followed by surgery/trauma (25%), whereas all patients ≤ 90 d had previous surgery. Indication for antifungal prescribing was prophylaxis in 38% and treatment in 62% [empirical (57%), preemptive (13%) and targeted (30%)]. Fluconazole was the most common agent both for prophylaxis [45%, median dose: 6 (range 2-9) mg/kg/d] and empirical treatment [53%, median dose: 10 (range 1-12) mg/kg/d], whereas LAMB was the most

frequent agent for targeted treatment [37%, median dose: 5 (range 3-6) mg/kg/d] (Table 1). Common reasons for empirical and targeted treatment were persistent fever in high-risk patients (58%) and candidiasis (100%), respectively. For targeted treatment, the most frequent pathogens were *Candida albicans* (37%) and *Candida parapsilosis* (32%).

Conclusions/Learning Points: The majority of antifungal prescriptions across European PICUs were for prophylaxis or empirical treatment. These data will be valuable for guiding antifungal stewardship strategies in PICUs

OP027 / #1566

ANTIFUNGAL PROPHYLAXIS WITH LIPOSOMAL AMPHOTERICIN B (LAMB) IN PAEDIATRIC PATIENTS WITH ACUTE LYMPHOBLASTIC LEUKAEMIA (ALL) DURING INDUCTION PHASE

Parallel Symposium

PARALLEL SYMPOSIUM: FUNGAL INFECTIONS IN PAEDIATRICS

Ritu Sharma¹, Paola Angelini¹, Laura Ferreras-Antolin²

¹Royal Marsden Hospital, Paediatrics, London, United Kingdom, ²ST GEORGE'S UNIVERSITY HOSPITALS NHS FOUNDATION TRUST, Paediatric Infectious Diseases, London, United Kingdom

Backgrounds: LAMB prophylaxis was started for ALL patients during induction chemotherapy in our institution secondary to an increased incidence of IFD (Invasive Fungal Disease). LAMB was chosen in view of the less pharmacological interactions with vincristine and its easy delivery in the community. Our study aimed to review the effectiveness and safety of this measure.

Methods: Retrospective single centre descriptive study from April 2019 to April 2020. ALL paediatric patients (<18 years) started on 2.5mg/kg twice a week intravenous LAMB during the induction phase of chemotherapy (UKALL11) were included. Toxicity, allergic/infusion reactions and breakthrough IFDs were recorded.

Results: 41 patients were included (23 male). Median age was 4.4 years (IQR 3.3-6.9). Disease profile was: B-ALL (34/41), T-ALL (2/41), Ph-ALL (2/41), ABL fusion (1/41), relapsed ALL(1/41). 38/41 patients received LAMB prophylaxis; for the remaining 3/41, LAMB was early discontinued (two cases due to allergic reactions to the testing dose and one case of possible IFD at day three of induction). A total of 23/38 (60.5%) patients presented deranged (grade 3 or 4) biochemistry results while receiving LAMB prophylaxis: hypokalemia (3/38), deranged ALT (23/38) and hyperbilirubinemia (1/38); no patients presented raised creatinine or hypomagnesemia. Only in one case, toxicity was attributed to LAMB and led to drug discontinuation. A total of 5/41(12%) patients presented allergic/infusion reactions: in three, this led to LAMB discontinuation (2/5 after the test dose and one case during the 4th week of prophylaxis). From the 5/41(12%) cases who had LAMB prophylaxis discontinued, 4 were changed to caspofungin and one started on LAMB treatment.

Conclusions/Learning Points: In our experience prophylactic intravenous LAMB presented a good safety profile. Allergic/infusion reactions wer the main reason for withdrawal. No breakthrough infections were identified.

MENTAL HEALTH AMONG CHILDREN WITH LONG COVID DURING THE COVID-19 PANDEMIC

Parallel Symposium

PARALLEL SYMPOSIUM: EFFECTS OF THE COVID-19 PANDEMIC

Liat Ashkenazi-Hoffnung^{1,2}, Iris Shachar-Lavie³, Maayan Shorer⁴, Hila Segal³, Silvana Fennig^{2,3}

¹Schneider Children's Medical Center, Department Of Day Hospitalization, Petah Tikva, Israel, ²Tel Aviv University, Sackler Faculty Of Medicine, Tel Aviv, Israel, ³Schneider Children's Medical Center, Psychological Medicine, Petah Tikva, Israel, ⁴Ruppin Academic Center, Clinical Psychology Program And The Lior Tsfaty Center For Suicide And Mental Pain Studies, Emek Hefer, Israel

Backgrounds: A growing number of studies report that individuals of all ages infected with SARS-CoV-2 may experience long-term persistent symptoms, known as long-COVID (LC) or post COVID-19 condition. The current study is one of the first attempts to examine the consequences of LC on children's mental health and academic function.

Methods: We compared the mental health of 103 children diagnosed with LC to a control group of 113 children, aged 4-18 years. Groups were prospectively recruited from November 2020 to August 2021. The LC group included children presenting to a designated multidisciplinary clinic for LC at a tertiary center with microbiologically- proven SARS-CoV-2 infection. Parents completed mental health questionnaires, evaluating the child's and the parent's distress, functional impairment, and exposure to COVID-19 stressful events. Bivariate Pearson correlation tests were used to explore the relationships between the study's variables. Two multiple regression analyses examined the variables contributing to children's mental health scores.

Results: Long COVID was associated with a higher functional impairment as children with LC exhibited a higher rate of online school absence, compared to controls. In addition, LC was associated with a higher rate of self-reported memory loss, compared to controls. However, other functional aspects such as peer relationships, engagement in physical activities, and emotional-behavioral problems did not differ between LC children and controls. Significant predictive factors for emotional-behavioral problems included parental concerns regarding their child's functioning and economic difficulties

Conclusions/Learning Points: LC was associated with impairments in some aspects of children's cognitive-academic functioning, but not with emotional-behavioral problems. Thus, interventional programs addressing school attendance in this population are warranted. Also, addressing parents' economic stress and concerns to their children's emotional adjustment during the pandemic are important for reducing pandemic-related emotional-behavioral problems among children.

A PARTICIPATORY SYSTEM ANALYSIS APPROACH TO CO-DESIGN ACCOMPANYING INTERVENTIONS FOR MORE EFFECTIVE SARS-COV-2 PREVENTION IN SCHOOLS

Parallel Symposium

PARALLEL SYMPOSIUM: EFFECTS OF THE COVID-19 PANDEMIC

Rosina Malagrida¹, Jordi Casabona², Jacqueline Broerse³

¹IrsiCaixa, Living Lab For Health, Badalona, Spain, ²Centre d'Estudis Epidemiològics sobre les Infeccions de Transmissió Sexual i Sida de Catalunya (CEEISCAT)-CIBERESP, Department Of Health, Generalitat De Catalunya, Badalona, Spain, ³VU Universiteit Amsterdam, Athena Institute, Amsterdam, Netherlands

Backgrounds: To avoid closing schools during the Covid-19 pandemic, the European Centre for Disease Prevention and Control (ECDC) has defined guidelines for the school setting. These include: (1) safety, hygiene-related measures and physical distancing measures, which should be adapted to different contexts and should consider the prevention, while providing an optimal learning and psychosocial environment and (2) crucial accompanying measures of risk communication and of community engagement to include the voice of children and other stakeholders. However, the practical implementation of both of these measures is not straightforward as they imply complex changes in schools, and, in order to address such complexity, the ECDC suggests the creation of community structures but there is a lack of guidelines on how to implement them.

Methods: In this paper we piloted a community structure with a participatory system analysis process where 44 teachers, 868 students and their families from 6 schools from Spain participated.

Results:

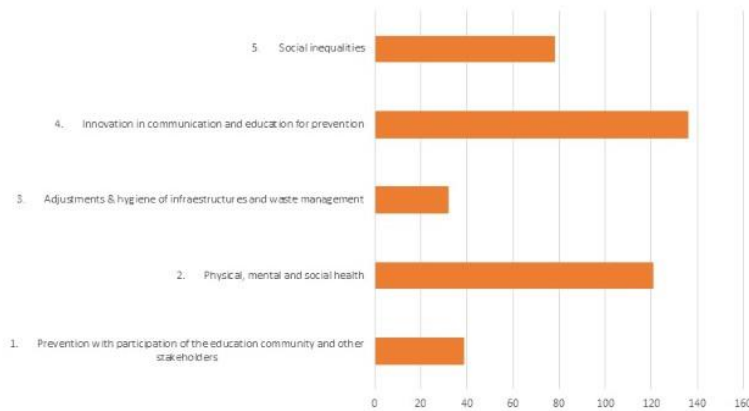

Figure 1. Number of items collected within each category of problems and opportunities for implementing Covid-19 prevention measures

They came up with a total of 406 items of problems and opportunities to implement prevention measures which addressed the complexity of the challenge. The results were clustered in 5 categories (Figure 1) and for each of them the participants co-defined 58 recommendations, based on which we came up with a final list of 15 priority accompanying recommendations.

Conclusions/Learning Points: We conclude that our approach could be used to develop inspiring guidelines to initiate community structures in schools to adapt the accompanying recommendations to each school setting context for more effective implementation of the prevention measures.

Acknowledgments CERCA Programme/Generalitat de Catalunya 2017 SGR. Sentinel School Network Study Group of Catalonia. CONNECT project, funded from the European Union's Horizon 2020 research and innovation programme under grant agreement no. 872814

UNRAVELLING THE FUNDAMENTAL LINK BETWEEN PNEUMOCOCCAL CARRIAGE, RESPIRATORY VIRAL INFECTION, AND PEDIATRIC INVASIVE PNEUMOCOCCAL DISEASES: A TIME SERIES ANALYSIS BASED ON MULTIPLE NATIONAL SURVEILLANCE SYSTEMS

Parallel Symposium

PARALLEL SYMPOSIUM: EFFECTS OF THE COVID-19 PANDEMIC

Alexis Rybak¹, Corinne Levy², Francois Angoulvant³, Anne Auvrignon², Piotr Gembara⁴, Kostas Danis⁵, Sophie Vaux⁵, Daniel Levy-Bruhl⁵, Sylvie Van Der Werf⁶, Stéphane Béchet², Stéphane Bonacorsi⁷, Zein Assad³, Andréa Lazzati⁸, Morgane Michel⁹, Florentia Kaguelidou⁹, Albert Faye³, Robert Cohen¹, Emmanuelle Varon¹⁰, Naim Ouldali¹

¹ACTIV, Paediatrics, Créteil, France, ²ACTIV, Association Clinique Et Thérapeutique Infantile Du Val-de-marne, Créteil, France, ³Hopital universitaire Robert Debré, Pediatric Infectious Diseases And Internal Medicine, Paris, France, ⁴AFPA, Association Française De Pédiatrie Ambulatoire, Paris, France, ⁵The National Public Health institute, Direction Des Maladies Infectieuses, Saint-Maurice, France, ⁶Institut Pasteur, National Reference Center For Respiratory Viruses, Paris, France, ⁷Assistance Publique–Hôpitaux de Paris - Robert Debre University Hospital, Department Of Microbiology, Paris, France, ⁸Centre Hospitalier Intercommunal de Créteil, Department Of General Surgery, Créteil, France, ⁹Assistance Publique–Hôpitaux de Paris - Robert Debré University Hospital, Eceve Inserm Umr 1123, Paris, France, ¹⁰CHI Créteil, Microbiology, Créteil, France

Backgrounds: An unbreakable relationship has been established between pneumococcal carriage and invasive pneumococcal disease (IPD), with IPD supposed to be the direct consequence of carriage dynamics. We aimed to assess the role of pneumococcal carriage dynamics and the viral epidemiology in the unprecedented IPD epidemiology related to non-pharmaceutical interventions (NPIs) implemented during the COVID-19 pandemic.

Methods: We performed a quasi-experimental interrupted time series analysis based on multiple national surveillance systems of pneumococcal carriage, respiratory syncytial virus (RSV) and influenza-related diseases, and IPD in children <15 years old in France. We estimated the fraction of IPD change after NPIs that was attributable to RSV, influenza and pneumococcal carriage dynamics, analyzed by a quasi-Poisson regression model.

Results: Between November 2006 and April 2021, 5113 IPD cases were included and 6831 healthy children had a swab test. After NPI implementation, the IPD incidence decreased 63% (95%CI, -82% to -43%, P<.001, Figure) while the overall pneumococcal carriage rate did not significantly change (-12%, 95%CI, -37% to 12%, P=.32). We estimated that 53% (95%CI, 28% to 78%, P<.001) and 40% (95%CI, 15% to 65%, P=.002) of the decrease in IPD in the NPI period was attributable to the change in influenza and RSV epidemiology, respectively. Only 4% (95%CI, -7% to 15%, P=.49) was attributable to a change in pneumococcal carriage. We found similar results when analyzing only high and low-disease potential

A) Invasive pneumococcal disease (IPD)

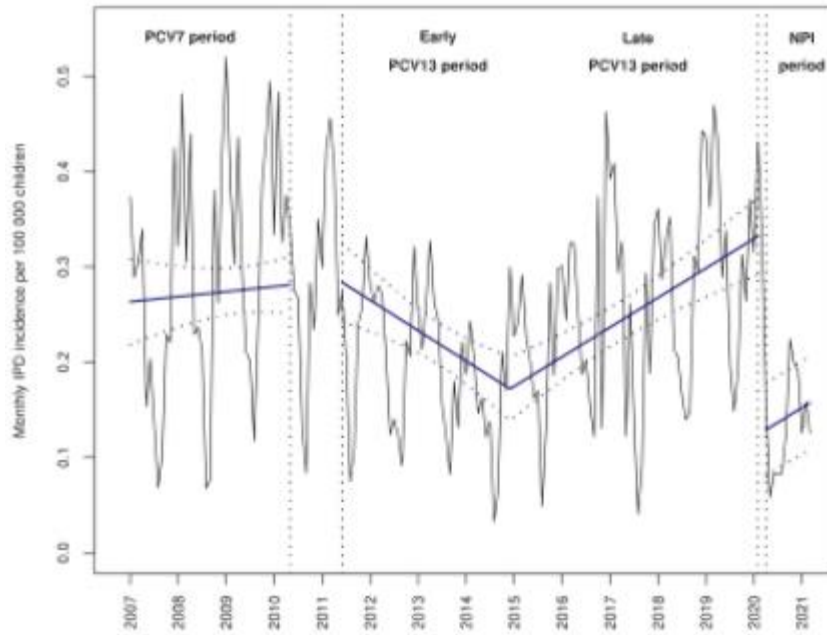

B) Pneumococcal carriage

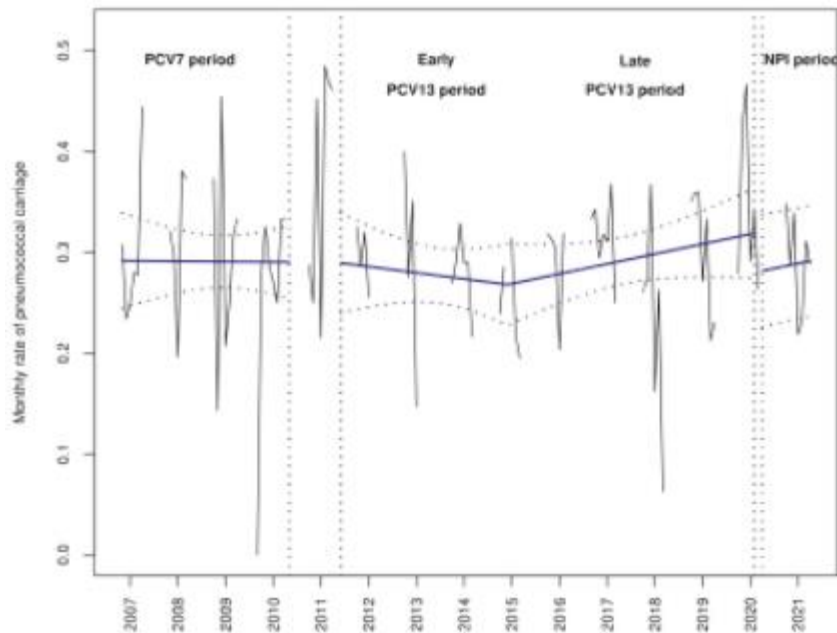

serotypes.

Conclusions/Learning Points: The major decrease in pediatric IPD incidence after NPIs was related to a change in viral dynamics rather than pneumococcal carriage. The fundamental link between pneumococcal carriage and IPD is highly affected by viral epidemiology. Interventions targeting respiratory viruses, such as immunoprophylaxis or vaccines against RSV and influenza, may prevent a large part of pediatric IPD.

JS001 / #1306

LONGITUDINAL ANALYSIS OF METABOLOMIC SERUM SIGNATURE IN PEDIATRIC PATIENTS WITH SARS-COV-2 INFECTION AND MIS-C PATIENTS COMPARED TO HEALTHY CONTROL.

Joint Symposium

JOINT SYMPOSIUM: PIDS-ESPID

Luca Pierri¹, Valentina Discepolo¹, Jacopo Troisi², Meritxwll Pujolassos^{1,2}, Andrea Catzola¹, Eugenia Bruzzese¹, Francesco Nunziata¹, Alfredo Guarino¹, Andrea Lo Vecchio¹

¹Department of Translational Medical Sciences, Pediatrics, Naples, Italy, ²Theoreo S.r.l. – Spin-off company of the University of Salerno, Medicine, Naples, Italy

Backgrounds: Metabolomic alterations have been identified in adults with SARS-CoV-2 infection, however this approach has not been used in children so far. Children usually have a mild course, although a small percentage may develop severe disease or Multisystem Inflammatory Syndrome (MIS-C).

Methods: We carried out a prospective comparative cohort study (April 2020 to June 2021) enrolling children referred to our COVID-center for symptoms related to acute SARS-CoV-2 infection (positive nasopharyngeal swab) or MIS-C and a cohort of age- and sex-matched children who served as controls. Metabolomic analysis was performed by Gas Chromatography Mass Spectroscopy approach using blood samples collected at admission, acute phase, discharge and a follow-up visit scheduled after negativization. All enrolled patients were hospitalized and classified into mild-to-moderate or severe COVID-19 according to clinical, radiological, and biochemical features.

Results:

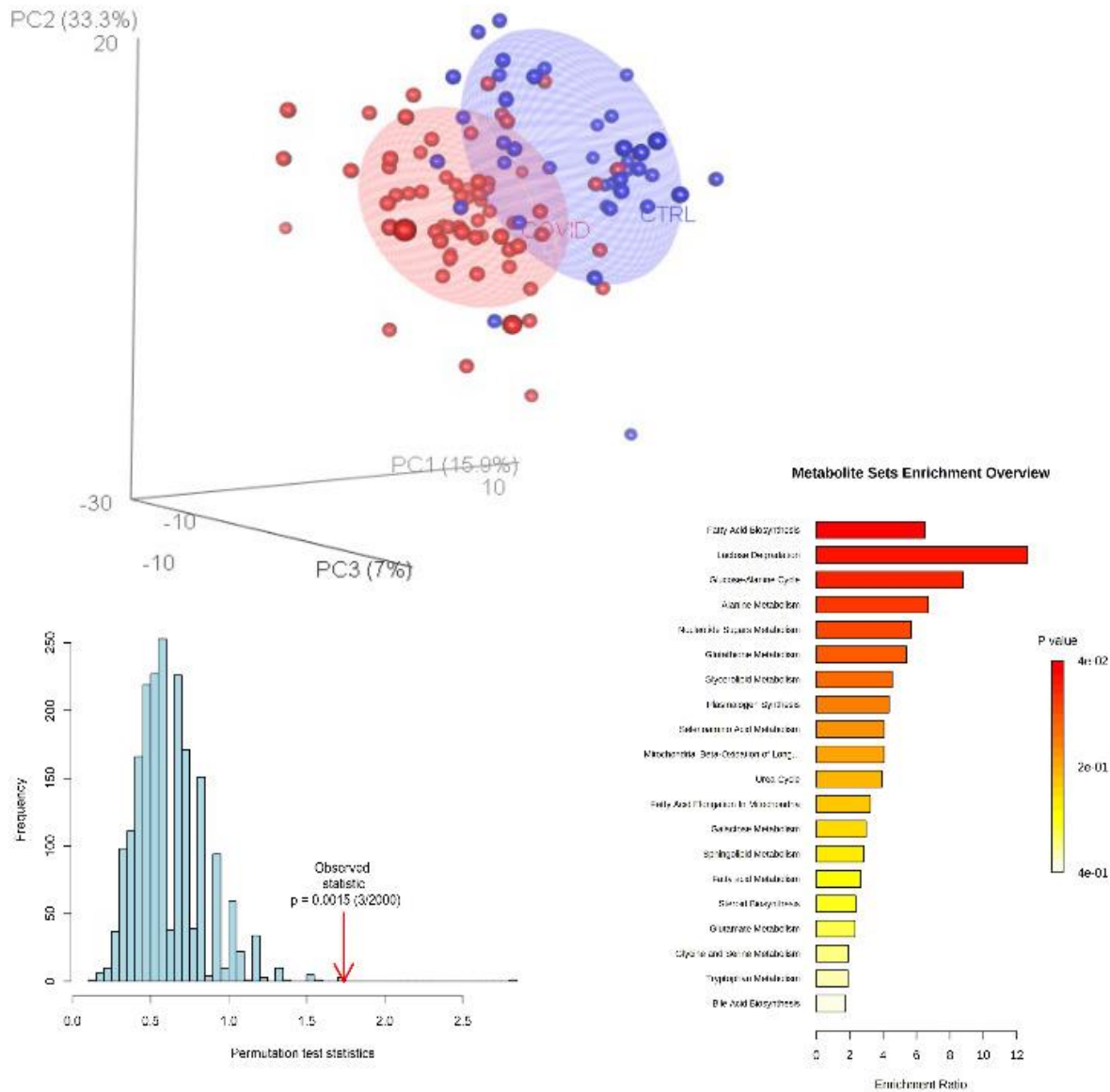

A specific metabolomic signature was identified in 92 children (48 males, mean age 3.69 ± 5.1 years) with acute SARS-CoV-2 infection, compared to 41 controls (permutation test statistic $p=0.0015$, Figure) involving specific pathways, such as: inflammation (spermidine and hypoxanthine), reactive oxygen species pathway (riboflavin) and glycerolipids pathways. Distinct metabolic signatures were significantly associated with child's age (mainly > 3 years), clinical and biochemical severity and timing from SARS-CoV-2 infection. Children with MIS-C ($n=9$) showed a unique metabolomic signature and different from age- and sex-matched SARS-CoV-2-infected patients or controls characterized by an alteration of spermidine and sphingolipids.

Conclusions/Learning Points: Pediatric SARS-CoV-2 infection has a characteristic metabolomic signature suggesting a possible involvement of intestinal microbiome, that varies according to patients' age and disease phenotype. Metabolomic approach may be a useful tool to identify possible early markers of disease and predictors of severe diseases evolution or multi-system inflammatory syndrome.

CHARACTERISTICS OF CHILDREN HOSPITALIZED WITH MIS-C DURING THREE PANDEMIC WAVES IN GREECE

Joint Symposium

JOINT SYMPOSIUM: PIDS-ESPID

Irini Eleftheriou¹, Despoina Maritsi¹, Stavroula Lampidi¹, Evaggelia Farmaki², Konstantina Charisi³, Petrina Vantsi³, Kleopatra Skourti⁴, Filippos Filippatos⁴, Ioannis Amplianitis⁵, Parthena Kampouridou⁶, Ioanna Grivea⁷, Kyriaki Papadopoulou-Legbelou⁸, Efimia Papadopoulou-Alataki⁸, Eleni Vergadi⁹, Despoina Gkentzi⁵, Despina Dimou¹⁰, Patra Koletsi¹⁰, Lampros Fotis¹¹, Vassiliki Papaevangelou¹¹, Emmanouil Galanakis⁹, George Syrogiannopoulos⁷, Vassiliki Spoulou⁴, Nikos Spyridis¹, Athanasios Michos⁴, Emmanuel Roilides³, Maria Tsolia¹

¹National and Kapodistrian University of Athens, Second Department Of Pediatrics, "p. & A. Kyriakou" Children's Hospital Of Athens, Athens, Greece, ²Aristotle University of Thessaloniki, Hippokration General Hospital, First Department Of Paediatrics, Thessaloniki, Greece, ³Aristotle University of Thessaloniki, Hippokration General Hospital, Third Department Of Pediatrics, Thessaloniki, Greece, ⁴National and Kapodistrian University of Athens, "Aghia Sophia" Children's Hospital, First Department Of Paediatrics, Athens, Greece, ⁵Patras Medical School, University General Hospital of Patras, Department Of Paediatrics, Patras, Greece, ⁶Genimatas General Hospital, Pediatric Department, Thessaloniki, Greece, ⁷Faculty of Medicine, School of Health Sciences, University of Thessaly, Department Of Pediatrics, Larissa, Greece, ⁸Aristotle University of Thessaloniki, Papageorgiou General Hospital, Fourth Department Of Paediatrics, Thessaloniki, Greece, ⁹Medical School, University of Crete, Department Of Paediatrics, Heraklion, Greece, ¹⁰Penteli Children's Hospital, Department Of Paediatrics, Athens, Greece, ¹¹National and Kapodistrian University of Athens, General University Hospital "Attikon", Third Department Of Paediatrics, Attikon University Hospital, Athens, Greece

Backgrounds: The Multisystem Inflammatory Syndrome in Children (MIS-C) is a rare but potentially severe complication of COVID-19.

Methods: This is a retrospective observational study of children aged <18 years hospitalized with MIS-C in 10 tertiary hospitals in Greece during three pandemic waves characterized by different SARS-CoV-2 variant: i. from August 2020 to January 2021 (EU1-B.1.177), ii. from February 2021 to July 2021 (Alpha-B.1.1.7) and iii. from August 2021 to December 2021 (Delta-B.1.617.2). The aim of the study was to document the incidence over time, clinical characteristics and outcome of children admitted with MIS-C in Greek hospitals during the COVID-19 pandemic.

Results:

| | 1 st wave | 2 nd wave | 3 rd wave |
|------------------------------|----------------------|----------------------|----------------------|
| Number of COVID-19 cases | 9.506 | 41.803 | 156.953 |
| Number of MIS-C cases | 32 | 47 | 40 |
| Gender, male/female (ratio) | 14:18 (0.77) | 32:15 (2.1) | 30:10 (3) |
| Median age (Q1-Q3) | 7.3 (3.4-10.2) | 8.8 (3.8-12.9) | 8.2 (5.4-13.9) |
| Cardiac involvement (%) | 20 (62.5) | 32 (68.1) | 25 (62.5) |
| -myocarditis (%) | 9 (28.1) | 19 (40.4) | 16 (40) |
| -pericarditis (%) | 8 (25) | 10 (21.3) | 8 (20) |
| -aneurysms (%) | 3 (9.4) | 3 (6.4) | 1 (2.5) |
| Mucocutaneous manifestations | 23 (71.9) | 29 (61.7) | 24 (60) |
| Gastrointestinal symptoms | 25 (78.1) | 36 (76.6) | 33 (82.5) |
| Respiratory symptoms | 9 (28.1) | 16 (34) | 13 (32.5) |
| Acute kidney injury | 3 (9.4) | 7 (14.9) | 7 (17.7) |
| ICU admission | 7 (21.9) | 14 (29.8) | 7 (17.5) |
| Death | 1 | 0 | 0 |

Table 1. Characteristics of children hospitalized with MIS-C during the three COVID-19 pandemic waves

In total, 119 patients were included, 91.6% (109/119) met the WHO criteria of MIS-C diagnosis: 26.9% (32/119), 39.5% (47/119) and 33.6% (40/119) were hospitalized during the 1st, 2nd, and 3rd study period, respectively. Demographic and clinical characteristics are shown in Table 1. No cases were found before October 2020. The incidence of MIS-C significantly decreased over the three waves from 3.3/1000 to 0.25/1000 confirmed COVID-19 cases ($P < 0.0001$). No other significant difference was observed in the clinical manifestations and disease severity of children hospitalized with MIS-C over the three waves.

Conclusions/Learning Points: This study indicates that the incidence of MIS-C may vary according to the predominant variant. Outcome remains favourable regardless of the variant leading to MIS-C. Larger studies are needed to clarify if clinical characteristics and/or disease severity may differ, as well.

THE IDENTIFICATION AND SUBSEQUENT CROSS-PLATFORM VALIDATION OF A HOST GENE EXPRESSION SIGNATURE FOR DIFFERENTIATING BETWEEN MIS-C AND OTHER INFECTIOUS AND INFLAMMATORY DISEASES

Joint Symposium

JOINT SYMPOSIUM: PIDS-ESPID

Heather Jackson¹, Luca Miglietta², Giselle D'Souza¹, Dominic Habgood-Cootte³, Priyen Shah⁴, Ortensia Vito¹, Samuel Nichols¹, Oliver Powell¹, Maisey Davidson¹, Chisato Shimizu⁵, Adriana Tremoulet⁵, Enitan Carrol⁶, Marieke Emonts⁷, Ulrich Von Both⁸, Federico Martín-Torres⁹, Pablo Rojo¹⁰, Werner Zenz¹¹, Maria Tsolia¹², Katy Fidler¹³, Luregn Schlapbach¹⁴, Michael Carter¹⁵, Aubrey Cunnington¹⁶, Victoria Wright³, Jethro Herberg³, Jane Burns⁵, Jesus Rodriguez-Manzano³, Myrsini Kaforou³, Michael Levin³

¹Imperial College London, Infectious Disease, London, United Kingdom, ²Imperial College London, Electrical And Electronic Engineering, London, United Kingdom, ³Imperial College London, Department Of Infectious Disease, London, United Kingdom, ⁴Imperial College London, Paediatric Infectious Diseases, London, United Kingdom, ⁵Rady Children's Hospital and University of California San Diego, Department Of Pediatrics, San Diego, United States of America, ⁶University of Liverpool, Institute Of Infection, Veterinary And Ecological Sciences Liverpool, Liverpool, United Kingdom, ⁷Newcastle University, Translational And Clinical Research Institute, Newcastle upon Tyne, United Kingdom, ⁸Dr. von Hauner, Division Of Paediatric Infectious Diseases, Munchen, Germany, ⁹Hospital Clínico Universitario de Santiago de Compostela, Translational Paediatrics And Infectious Diseases, Paediatrics Department, Santiago de Compostela, Spain, ¹⁰HOSPITAL 12 DE OCTUBRE, Paediatrics, MADRID, Spain, ¹¹Medical University of Graz, Department Of General Paediatrics, Graz, Austria, ¹²School of Medicine, National and Kapodistrian University of Athens, 2nd Department Of Pediatrics, "p. & A. Kyriakou" Children's Hospital, Athens, Greece, ¹³Royal Alexandra Children's Hospital, Paediatrics, Brighton, United Kingdom, ¹⁴University Children's Hospital Zurich, Pediatrics, Zurich, Switzerland, ¹⁵Evelina London Children's Hospital, Paediatric Intensive Care, London, United Kingdom, ¹⁶Imperial College London, Infectious Diseases, London, United Kingdom

Backgrounds: Multisystem Inflammatory Syndrome in Children (MIS-C) occurs several weeks after SARS-CoV-2 infection with symptoms including fever, shock and multiorgan failure. Clinical features of MIS-C overlap with Kawasaki Disease (KD), bacterial, and viral infections, making accurate diagnosis challenging. Host genes, measurable through whole blood transcriptomics, are an alternative tool for diagnosing infectious and inflammatory diseases.

Methods: Patients with MIS-C, KD, bacterial, and viral infections were recruited to the EU-funded PERFORM and DIAMONDS studies and the NIH-funded PREVAIL study. Patients were phenotyped using a standardised algorithm. Genome wide RNA sequencing of whole blood was undertaken, and feature selection was performed to identify a diagnostic signature for distinguishing between MIS-C and other infectious and inflammatory conditions. The expression levels of the genes identified were measured using RT-qPCR assays in an independent validation cohort.

Results: Through feature selection and differential expression analysis, 11 genes with diagnostic potential were identified and taken forward into cross-platform validation using RT-qPCR. With up to 11 genes, it was possible to distinguish between MIS-C vs. KD, bacterial, and viral infections with high accuracy, with an AUC of 92.9% (95% CI: 88.2%-97.6%) in the validation cohort. The diagnostic gene signature retained its high performance when tested within the groups separately in the validation cohort: MIS-C vs. bacterial infections (AUC: 94.6%), vs. viral infections (AUC: 93.1%), and vs. KD (AUC: 89.8%).

Conclusions/Learning Points: Despite the clinical similarities between MIS-C and other infectious and inflammatory conditions, there are key differences in gene expression profiles that can be used in diagnostic contexts. It will be necessary for the genes reported here to undergo further validation prior to their development into tests with clinical utility.

JS004 / #583

SEVERE BACTERIAL INFECTIONS IN PREVIOUSLY HEALTHY CHILDREN AS A FIRST MANIFESTATION OF PRIMARY IMMUNODEFICIENCY: A 7-YEAR SINGLE-CENTER RETROSPECTIVE ANALYSIS OF ROUTINE IMMUNOLOGICAL TESTING

Joint Symposium

JOINT SYMPOSIUM: ESID-ESPID

Sophie Strasser¹, Christoph Berger², Johannes Trück¹

¹University Children's Hospital Zurich, Immunology & Infectious Diseases, Zürich, Switzerland, ²University Children's Hospital Zurich, Infectious Diseases, Zürich, Switzerland

Backgrounds: Severe bacterial infections (SBI) in otherwise healthy children are rare, and they might represent a first clinical manifestation of primary immunodeficiency (PID). However, it is unclear which children should be assessed at all and how. We aimed to support clinical decision-making by characterizing the frequency and features of PID in otherwise healthy children after an episode of SBI.

Methods: We retrospectively analyzed epidemiological, microbiological and immunological data from hospital records at the University Children's Hospital Zurich, Switzerland. We included children who were previously healthy, aged 3d-18y at SBI diagnosis, and were diagnosed and/or immunologically followed-up between 01/01/2013 and 31/03/2020. Children with proven or clinically diagnosed SBI with pleuropneumonia, meningitis, and/or sepsis who were routinely followed up and screened for PID were included.

Results: We identified 432 children with SBI, and after excluding those without general consent, a final SBI cohort of 360 children remained (median age 3.4 years). Outpatient follow-up data were available for 265 (74%) children. Immunological testing was performed in 244 children (92%), whereas 21 patients (8%) were assessed clinically only. Laboratory abnormalities were detected in 51 of 244 patients (21%), revealing 38 definite PID cases (16%). Selective deficiencies in IgA and/or IgM (n=24) and hypogammaglobulinemia (IgG deficiency, n=8) were the most common, but PID diagnoses also included two cases of specific antibody deficiency and one case each of C2 deficiency, C7 deficiency, properdin deficiency and autoimmune neutropenia.

Conclusions/Learning Points: Routine testing for PID after an episode of SBI in children revealed abnormal immunological laboratory tests in 21% of children. Although the clinical significance of some of these findings remains unclear, their identification allows optimal counseling of families and optimization of preventive measures such as additional vaccinations to avoid future SBI episodes.

THE INFLUENCE OF THE TREATMENT WITH LEDIPASVIR/SOFOSBUVIR ON THE BODY MASS INDEX Z-SCORES IN CHILDREN WITH CHRONIC HEPATITIS C.

Joint Symposium

JOINT SYMPOSIUM: ESPGHAN-ESPID

Maria Pokorska-Śpiwak^{1,2}, Anna Dobrzeniecka², Magdalena Marczyńska^{1,2}

¹Medical University of Warsaw, Department Of Children's Infectious Diseases, Warsaw, Poland, ²Regional Hospital of Infectious Diseases in Warsaw, Department Of Children's Infectious Diseases, Warsaw, Poland

Backgrounds: There are scarce data available on the influence of direct acting antivirals used for the treatment of chronic hepatitis C (CHC) on the growth parameters in children. In this study we aimed to analyze the body mass index (BMI) z-scores in children treated with ledipasvir/sofosbuvir (LDV/SOF).

Methods: We included 38 patients (22 boys) aged 10-17 years treated with LDV/SOF for CHC (33 infected with genotype 1 and 5 with genotype 4; 36 were treated for 12 weeks, and 2 for 24 weeks). BMI z-scores were calculated using the WHO Anthropometric calculator AnthroPlus v. 1.0.4. at baseline, after 4 weeks of treatment, at the end of treatment (EOT), and 12 weeks after the EOT. Correlations between BMI z-scores and liver fibrosis (liver stiffness measurement, LSM), aspartate transaminase (AST)-to-platelets ratio index (APRI), and the Fibrosis-4 index (FIB-4) and liver steatosis (controlled attenuation parameter, CAP) were analyzed.

Results: At baseline, 5/38 (13%) of patients were obese (BMI z-score >2 SD), 4/38 (11%) overweight, and 29 (76%) normal. Mean BMI z-scores were 0.22±1.17 at baseline, 0.12±1.19 after 4 weeks of treatment, 0.04±1.29 at EOT, and 0.29±1.32 at 12 weeks after EOT. All the differences were statistically insignificant. No differences were observed when analyzing BMI z-score values separately for boys and girls. Baseline BMI z-scores correlated with alanine aminotransferase level ($r=0.33$, 95% CI 0.01-0.58, $p=0.04$), LSM ($r=0.40$, 95% CI 0.09-0.65, $p=0.01$), APRI ($r=0.33$, 95% CI 0.02-0.59, $p=0.03$), and CAP ($r=0.40$, 95% CI 0.08-0.64, $p=0.01$). No similar correlations were reported at 12 weeks posttreatment.

Conclusions/Learning Points: Treatment with LDV/SOF in children with CHC (genotypes 1 and 4) did not show any significant influence on the patients' growth. Higher baseline BMI z-score correlated with more advanced liver fibrosis and steatosis.

POOLED EFFICACY OF NIRSEVIMAB AGAINST RSV LOWER RESPIRATORY TRACT INFECTION IN PRETERM AND TERM INFANTS

Oral Presentations Session

ORAL PRESENTATION SESSION 01: RESPIRATORY INFECTIONS

Eric Simões¹, Shabir Madhi², Heather Zar^{3,4}, Miroslava Bosheva⁵, William Muller^{6,7}, Therese Takas⁸, M Pamela Griffin⁸, Amanda Leach⁸, Yuan Yuan⁸, Tonya Villafana⁸

¹Children's Hospital Colorado, -, Aurora, United States of America, ²University of the Witwatersrand, South African Medical Research Council Vaccines And Infectious Diseases Analytics Research Unit, Faculty Of Health Sciences, Johannesburg, South Africa, ³Red Cross Children's Hospital, Department Of Paediatrics And Child Health, Cape Town, South Africa, ⁴University of Cape Town, Sa-mrc Unit On Child And Adolescent Health, Cape Town, South Africa, ⁵University Multiprofile Hospital for Active Treatment Sv. Georgi Medical University, -, Plovdiv, Bulgaria, ⁶Ann & Robert H. Lurie Children's Hospital of Chicago, -, Chicago, United States of America, ⁷Northwestern University Feinberg School of Medicine, -, Chicago, United States of America, ⁸AstraZeneca, -, Gaithersburg, United States of America

Backgrounds: Nirsevimab reduced medically attended (MA) respiratory syncytial virus (RSV) lower respiratory tract infection (LRTI) incidence in two double-blind, placebo-controlled studies (Phase IIb [NCT02878330]: healthy very and moderately preterm infants ≥ 29 to < 35 weeks gestational age [wkGA], efficacy 70.1%; Phase III: MELODY [NCT03979313], healthy term and late preterm infants ≥ 35 wkGA, efficacy 74.5%). We report a pooled efficacy analysis of nirsevimab in term and preterm infants ≥ 29 wkGA through Day 151.

Methods: Infants were randomised 2:1 to receive either an intramuscular injection of nirsevimab (< 5 kg, 50 mg; ≥ 5 kg, 100 mg) or placebo, before their first RSV season. Data were pooled from the Phase IIb and MELODY studies for those infants under the optimised dosing regimen (i.e., infants < 5 kg at dosing and receiving the 50 mg dose from Phase IIb and all infants in MELODY) to evaluate efficacy (relative risk reduction versus placebo) against varying severities of MA RSV LRTI.

Results: Overall, 860 infants from Phase IIb (median age at randomisation: 1.60 [range 0.1–6.4] months; female: 47.6%) and 1490 infants from MELODY (median age at randomisation: 2.60 [0.03–11.10] months; female: 48.4%) were included. Demographics were comparable across studies, except for GA and age at randomisation. Nirsevimab had an efficacy of 79.5% against MA RSV LRTI, 77.3% against RSV LRTI hospitalisation and 86.0% against very severe RSV LRTI through Day 151 (Figure). Consistent efficacy was observed across subgroups defined by age at randomisation, sex, ancestry, weight or geographical region and across endpoints of differing disease severity.

Conclusions/Learning Points: In a pooled analysis of two randomised, placebo-controlled studies, prophylaxis with nirsevimab demonstrated consistent efficacy across severities of RSV LRTI through Day

Figure. Pooled analysis of the efficacy of nirsevimab in reducing RSV LRTI across Phase IIb and Phase III MELODY studies

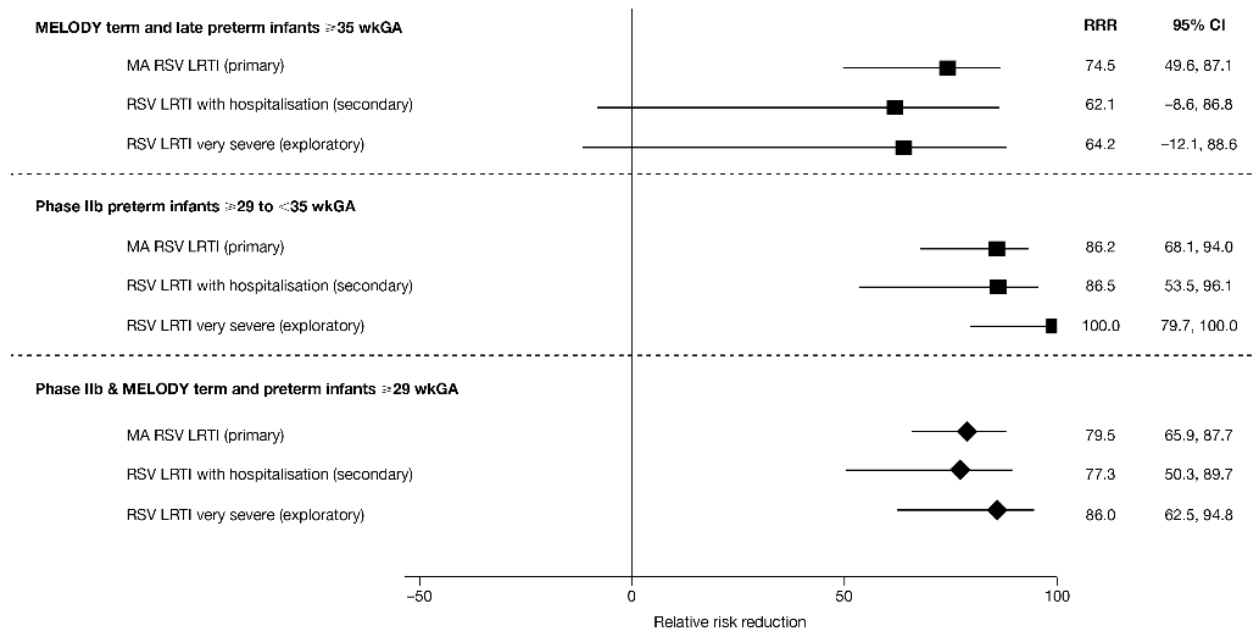

Only infants <5 kg were included from Phase IIb, as infants received 50 mg regardless of age and weight in this study. MA RSV LRTI was defined as RSV PCR positive on central laboratory testing, a sign of LRT involvement of at least one of rhonchi, rales, crackles or wheeze, and at least one sign of severity including increased respiratory rate (≥ 60 breaths/min, age < 2 months; ≥ 50 breaths/min, age 2–6 months; ≥ 40 breaths/min, age >6 months), hypoxemia at room air (O_2 saturation <95% at ≤ 1800 m, <92% at >1800 m) or clinical signs of respiratory distress (new onset apnea, retractions, grunting, nasal flaring, acute hypoxic or ventilatory failure, dehydration due to respiratory distress). RSV LRTI hospitalization was defined as a case of MA RSV LRTI requiring hospitalization. RSV LRTI very severe was defined as an RSV LRTI hospitalization requiring supplemental O_2 or intravenous fluids.

CI, confidence interval; LRTI, lower respiratory tract infection; MA, medical attended; RRR, relative risk reduction; RSV, respiratory syncytial virus; wkGA, weeks gestational age.

O002 / #702

EXAMINING THE RELATIONSHIP BETWEEN RESPIRATORY SYNCYTIAL VIRUS, INFLUENZA, AND ROTAVIRUS SEASONS' TIMING AND SEVERITY, AND INFANT AGE AT VIRAL SEASONS' PEAKS, WITH SUBSEQUENT CHILDHOOD ASTHMA

Oral Presentations Session

ORAL PRESENTATION SESSION 01: RESPIRATORY INFECTIONS

Michelle Dimitris¹, Steven Brunwasser², Sarah Buchan³, Daniel Feikin⁴, Jeffrey Kwong⁵, David Savitz⁶, Susan Schultz⁷, Erin Sparrow⁴, Deshayne Fell⁸

¹Children's Hospital of Eastern Ontario (CHEO), Research Institute, Ottawa, Canada, ²Rowan University, Psychology, Glassboro, United States of America, ³Public Health Ontario, Health Protection, Toronto, Canada, ⁴World Health Organization, Immunization, Vaccines, And Biologicals, Geneva, Switzerland, ⁵University of Toronto, Dalla Lana School Of Public Health, Toronto, Canada, ⁶Brown University, School Of Public Health, Providence, United States of America, ⁷Institute for Clinical and Evaluative Sciences, Ices, Toronto, Canada, ⁸UNIVERSITY OF OTTAWA AND CHILDREN'S HOSPITAL OF EASTERN ONTARIO RESEARCH INSTITUTE, School Of Epidemiology And Public Health, Ottawa, Canada

Backgrounds: Most infants are exposed to respiratory syncytial virus (RSV) in the first year of life. Studies have observed an association between severe RSV infection and asthma, yet it is unclear if this relationship is causal or due to underlying factors that increase susceptibility to both conditions. One study partially mitigated the influence of these factors by examining the relationship between infant age at winter virus peak and subsequent asthma. We extended this approach by examining infant age at RSV, influenza, and rotavirus peaks, as well as proxies for the timing and severity of RSV, influenza, and rotavirus seasons, and their relationships with subsequent incidence of childhood asthma.

Methods: We analyzed province-wide administrative data for 1,437,731 infants born in Ontario, Canada from 2002-2013. We ascertained RSV, influenza, and rotavirus hospitalizations by 1 year and asthma by 5 years of age using inpatient/outpatient ICD-9/10 codes. We used regression models to investigate: (1) infant age in the calendar week with highest incidence of hospitalization for each virus and subsequent asthma (unit of analysis infant); (2) incidence of RSV-, influenza-, and rotavirus-related hospitalizations by 1 year and asthma by 5 years (unit of analysis calendar week of birth).

Results: We observed highest likelihood of subsequent asthma at infant ages of approximately 13-, 11-, and 16-weeks during RSV, influenza, and rotavirus peaks, respectively. We observed apparent seasonal variation in childhood asthma by infant week of birth. The relationship between RSV seasonal variation and asthma appeared small in magnitude, while an unexpected relationship between rotavirus seasonal variation and asthma emerged (Figure).

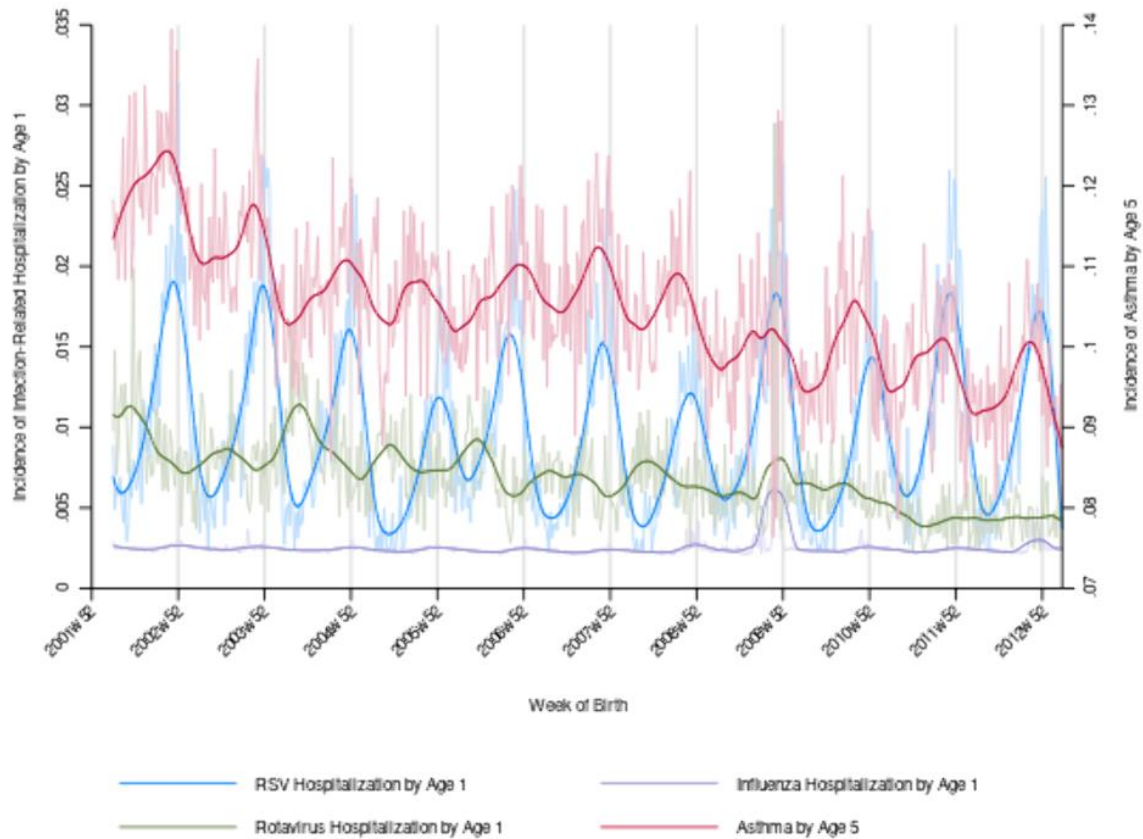

Conclusions/Learning Points: We find limited evidence in support of a causal relationship between RSV and asthma, and suggest further investigation of other mechanisms, including underlying seasonal characteristics.

O003 / #905

**NIRSEVIMAB FOR THE PREVENTION OF RESPIRATORY SYNCYTIAL VIRUS INFECTION:
NEUTRALISING ANTIBODY LEVELS FOLLOWING A SINGLE DOSE**

Oral Presentations Session

ORAL PRESENTATION SESSION 01: RESPIRATORY INFECTIONS

Deidre Wilkins, Yuan Yuan, Yue Chang, Anastasia Aksyuk, Michael Abram, Amanda Leach, Tonya Villafana, Mark Esser

AstraZeneca, -, Gaithersburg, United States of America

Backgrounds: Respiratory syncytial virus (RSV) is a major cause of lower respiratory tract infection (LRTI) and hospitalisation in infants. In two global, pivotal, placebo-controlled studies, nirsevimab, a monoclonal antibody to the RSV fusion protein with extended half-life, reduced medically attended RSV LRTI versus placebo throughout the RSV season (Phase III NCT03979313: MELODY, healthy term and late preterm infants, 74.5%; Phase IIb NCT02878330: healthy preterm infants, 70.1%). We measured RSV neutralising antibodies (Nab) from these studies through Day 361.

Methods: Infants were randomised 2:1 to receive one intramuscular injection of nirsevimab or placebo, before their first RSV season. Serum samples collected pre- and post-dose were tested in a validated RSV neutralisation assay; RSV Nab levels are reported in international units (IU)/mL.

Results: Overall, 1402 infants from MELODY and 741 infants from Phase IIb had available data. Baseline geometric mean RSV Nab levels were similar in both studies (MELODY, 134 IU/mL; Phase IIb, 87 IU/mL). At Day 151, nirsevimab recipients exhibited RSV Nab levels approximately 50-fold higher (MELODY, 6901 IU/mL; Phase IIb, 4799 IU/mL) versus baseline, with highest levels sampled at Day 31 in MELODY (19,711 IU/mL; Figure) and at Day 91 in Phase IIb (8479 IU/mL); levels remained >7-fold higher through Day 361 (MELODY, 978 IU/mL; Phase IIb, 739 IU/mL). At Day 361, placebo recipients with no confirmed RSV infection during the studies had RSV Nab levels of 38–48 IU/mL; nirsevimab recipients had RSV Nab levels of 757–982 IU/mL, >19-fold higher than placebo recipients without confirmed RSV infection.

Conclusions/Learning Points: Following immunisation with nirsevimab, RSV Nab levels at Day 151 were approximately 50-fold higher than baseline. RSV Nab levels remained high through Day 361, suggesting protection beyond Day

151.

Figure. RSV neutralising antibody levels from baseline following immunisation with nirsevimab or placebo in A) Phase IIb and B) MELODY.

A

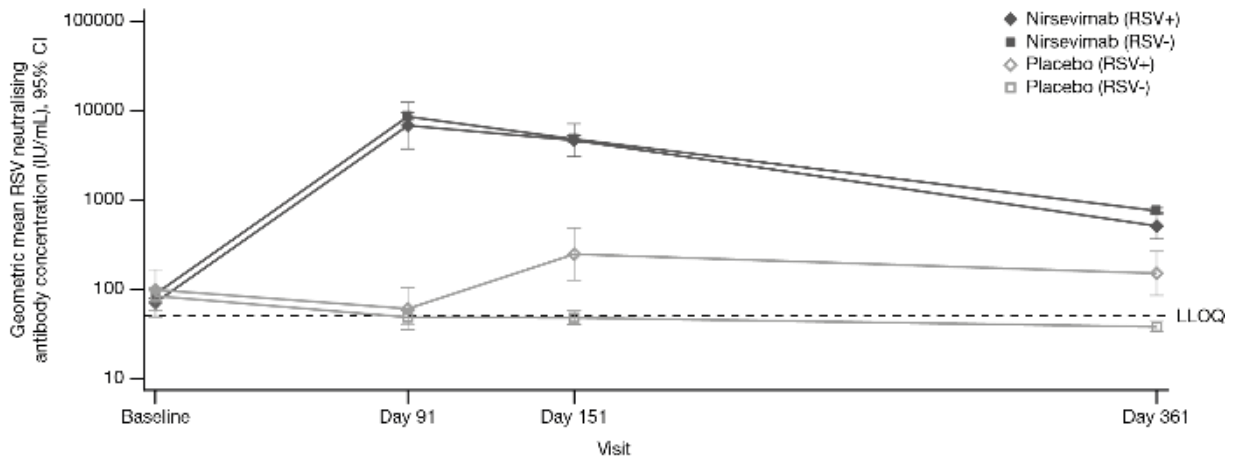

B

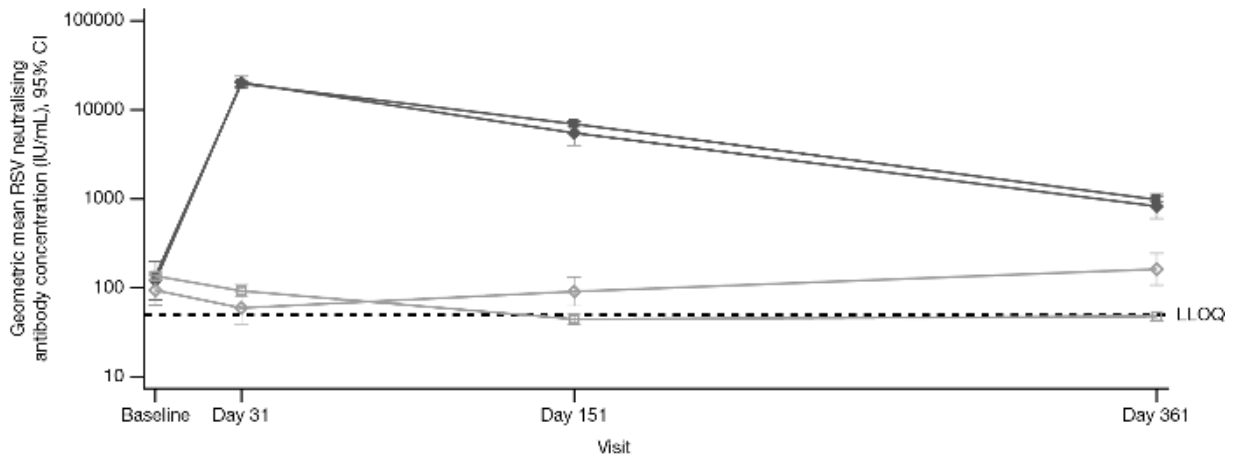

CI, confidence interval; LLOQ, lower limit of quantification; RSV, respiratory syncytial virus; RSV+, confirmed positive RSV infection; RSV-, no confirmed RSV infection or not tested.

IMPACT OF RESPIRATORY PATHOGEN PCR CYCLE THRESHOLD VALUE ON THE CLINICAL SEVERITY OF INFECTION IN ACUTELY ILL CHILDREN

Oral Presentations Session

ORAL PRESENTATION SESSION 01: RESPIRATORY INFECTIONS

Suvi Mattila^{1,2}, Niko Paalanne^{1,2}, Minna Honkila^{1,2}, Tuomas Jartti^{1,2}, Olli Ruuskanen³, Matti Waris⁴, Tytti Pokka^{1,2}, Terhi Tapiainen^{1,2}

¹University of Oulu, Pedego Research Unit And Medical Research Center Oulu, Oulu, Finland, ²Oulu University Hospital, Department Of Pediatrics And Adolescent Medicine, Oulu, Finland, ³Turku University Hospital, Department Of Pediatrics, Turku, Finland, ⁴University of Turku and Clinical Microbiology, Turku University Hospital, Finland, Institute Of Biomedicine, Turku, Finland

Backgrounds: The polymerase chain reaction (PCR) cycle threshold (Ct) value represents the number of amplification cycles required to yield a positive test result and inversely correlates with pathogen load. Here, we evaluated whether Ct values of respiratory pathogens were associated with the clinical severity of infections in acutely ill children.

Methods: In this cross-sectional study at a pediatric emergency department, we obtained nasopharyngeal swabs from 800 children with fever or respiratory symptoms. Samples were analyzed for 21 respiratory pathogens using point-of-care multiplex-PCR device (Qiasat). We compared Ct values in children who needed hospitalization and those who were discharged from ED using a multivariate logistic regression model adjusted for age and sex. In addition, the association of Ct values with CRP values was analyzed with linear regression.

Results: Of the 800 participants, 356 (45 %) were girls. The median age was 3.0 years. At least one pathogen was detected in 594 (74 %) participants. The most common pathogen was picornavirus, i.e. rhinovirus or enterovirus (328, 41 %) followed by RSV (133, 17 %). In total, 334 (42 %) patients were hospitalized, ranging from 11 % (3/27) for those with influenza A to 61 % (81/133) for those with RSV infection (Figure). When adjusted for age and sex, no statistically significant associations between Ct-value and need for hospitalization were found for any pathogen. In participants with detection of rhino/enterovirus, high Ct-value, i.e. low viral load, associated with high CRP value (β coefficient 2.51 [95 % CI 0.79 to 4.22]).

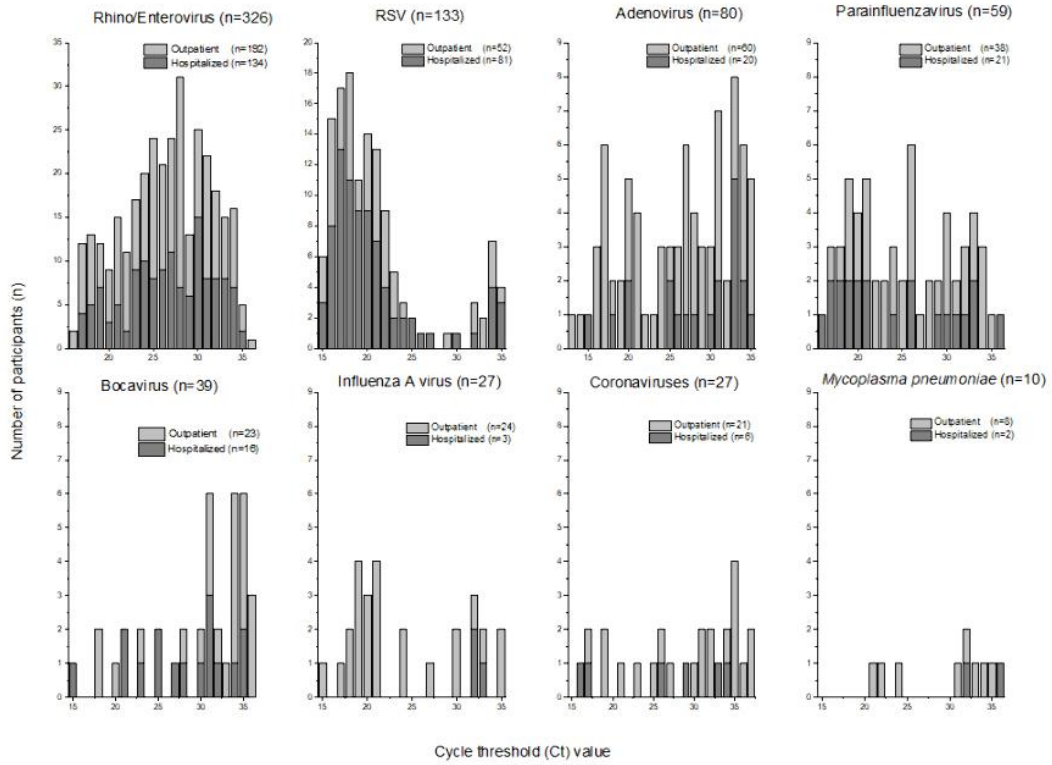

Conclusions/Learning Points: Viral or pathogen load, estimated by PCR cycle threshold values, was not associated with the need for hospitalization due to respiratory viral infection in children. Thus, the clinical utility of Ct-values appears to be limited.

O005 / #1315

PROBIOTICS CAN REDUCE FEVER EPISODES, RUNNY NOSE AND IMPROVE ATTENDANCE TO DAY CARE IN PRESCHOOL CHILDREN

Oral Presentations Session

ORAL PRESENTATION SESSION 01: RESPIRATORY INFECTIONS

Maria Stolaki¹, Stellan Hakansson², Mehriman Yaman³, Alexander Hakansson⁴, Eva Hakansson⁵

¹Winclove Probiotics, Patient-centered Clinical Development, Amsterdam, Netherlands, ²Umea University, Paediatrics, Umea, Sweden, ³Essum, Statistics, Umea, Sweden, ⁴Umea University, Nursing/ambulance Care, Umea, Sweden, ⁵Umea University, Clinical Microbiology, Umea, Sweden

Backgrounds: Respiratory infections (RI) are characterized by significant morbidity and represent a very common health problem in the first years of life, requiring multiple physician visits and often hospitalization, with significant implications for the patient's family. The risk of RI and gastrointestinal infections is 2 to 3 times higher in children attending childcare (preschool) compared to children cared for at home. Probiotics have demonstrated in various studies efficacy in reducing RI symptoms.

Methods: In this double blind, placebo-controlled study, healthy preschool children aged 1 to 5 years received a probiotic supplement daily for 6 months to assess the effect on presence or absence at school and on the incidence of upper respiratory tract infection symptoms. The intervention comprised of *Streptococcus oralis* 89a, *Lactobacillus rhamnosus* LB21, *Lactococcus lactis* W19, *Lactococcus lactis* L1A and *Bifidobacterium lactis* W51 at 2×10^9 CFUs daily or placebo.

Results: In total 61 children finished the study and were included in the analysis. The total number of healthy days at preschool child care in the probiotic group was significantly higher than that in the placebo group. Incidence of fever and runny nose were significantly lower in the probiotic group compared to placebo. No statistical difference was found between the groups when acute otitis media and upper respiratory infection were studied.

Conclusions/Learning Points: Our findings indicate that 6 months daily supplementation with probiotics reduces the incidence of fever, runny nose, and absence at preschool in children of age 1 to 5 years.

O006 / #660

PHARMACOKINETICS AND SERUM NEUTRALIZING ACTIVITY FROM A PHASE 1B/2A STUDY IN INFANTS SUPPORT MODEL-BASED EFFICACY PREDICTIONS FOR MK-1654, AN RSV NEUTRALIZING MONOCLONAL ANTIBODY

Oral Presentations Session

ORAL PRESENTATION SESSION 01: RESPIRATORY INFECTIONS

Brian Maas¹, Radha Raikar¹, Xin Cao¹, Farina Hellman², Sinoeun Touch¹, Andrea Krick¹, Luzelena Caro¹, Jeffrey Sachs¹, Jingxian Chen¹, Nele Plock², S. Y. Amy Cheung², Kalpit Vora¹, Brad Roadcap¹, Antonios Aliprantis¹, Andrew Lee¹

¹Merck & Co., Inc, Research, Kenilworth, United States of America, ²Certara, Research, Princeton, United States of America

Backgrounds: MK-1654 is an investigational RSV-neutralizing monoclonal antibody in development for the prevention of medically-attended lower respiratory tract infection (MALRI) in infants. This work summarizes interim pharmacokinetic (PK) and serum neutralizing antibody (SNA) results in infants. The efficacy of MK-1654 is also predicted using a published model.

Methods: This phase 1b/2a double-blind, randomized, placebo-controlled, study evaluated the safety, tolerability, PK, and SNA of MK-1654 in pre-term (born 29-35 weeks gestational age) and full-term infants. Participants (n=180) 2 weeks to 8 months of age were randomized in a 4:1 ratio within five separate panels (pre-term: 20, 50, 75 or 100-mg, full-term: 100mg) to receive a single intramuscular dose of MK-1654 or placebo. Blood samples were collected to quantify MK-1654 serum concentrations and SNA titers. A preliminary population PK (popPK) model was developed to describe PK of MK-1654 in infants. The efficacy of MK-1654 was predicted using clinical trial simulations which were based on the popPK model and a published model-based meta-analysis.

Results: Concentration data from 111 pre-term infants and 32 full-term infants through at least 150 days post-administration were available. The pharmacokinetics of MK-1654 were best characterized by a linear two-compartment popPK model with first-order absorption and elimination. Clearance and volume of distribution (Vd) were scaled allometrically using time-varying body weight. Age was also a covariate on Vd. The half-life of MK-1654 was approximately 42 days. A linear relationship was observed between increasing concentrations of MK-1654 and increasing SNA. Clinical trial simulations predict that a single dose of ≥ 75 mg of MK-1654 will provide $>75\%$ efficacy for the prevention of RSV MALRI for a duration of 5 months in infants.

Conclusions/Learning Points: These findings support the continued evaluation of MK-1654 in ongoing Phase 3 studies.

O007 / #1070

GENOMICS OF ALL-CAUSE PNEUMONIA AMONG NEPALESE CHILDREN

Oral Presentations Session

ORAL PRESENTATION SESSION 01: RESPIRATORY INFECTIONS

Rama Kandasamy¹, Meeru Gurung², Sagida Bibi³, Sonu Shrestha³, Daniel O'Connor³, Clive Hoggart^{4,5}, Stephen Thorson², Michael Carter⁶, Dominic Kelly³, David Murdoch⁷, Michael Levin⁴, Andrew Pollard³, Shrijana Shrestha²

¹University of New South Wales, Women's And Children's Health, Randwick, Australia, ²Patan Academy of Health Sciences, Paediatric Research Unit, Kathmandu, Nepal, ³University of Oxford, Paediatrics, Oxford, United Kingdom, ⁴Imperial College London, Department Of Infectious Disease, London, United Kingdom, ⁵Icahn School of Medicine at Mount Sinai, Department Of Genetics And Genomic Sciences, New York City, United States of America, ⁶King's College London, Women And Children's Health, London, United Kingdom, ⁷University of Otago, Pathology And Biomedical Science, Christchurch, New Zealand

Backgrounds: Determining the key genomic characteristics of childhood pneumonia may inform the development of new clinical interventions for the disease. We used a genome-wide association study (GWAS) to identify variants associated with all-cause pneumonia and subsequently used these data to identify eQTL.

Methods: DNA and peripheral blood RNA were collected from healthy Nepalese children and Nepalese children admitted to Patan Hospital, Kathmandu with clinician diagnosed pneumonia. Samples were genotyped using Illumina Global Screening Arrays. Array data underwent QC and filtering before imputation using the HRC R1.1 2016 reference panel. Association analysis, by conducting a logistic regression using multidimensional scaling values, was performed using PLINK 2. RNA underwent whole-transcriptome sequencing using Illumina HiSeq4000, 75bp paired-end reads. Count data underwent filtering, normalisation, and batch correction, before eQTL were identified using MatrixeQTL.

Results: A GWAS of 773 children with pneumonia (cases) and 2121 healthy community-based children (controls) identified rs79755386, proximal to B3GLT (involved in glycosylating o-linked mucins) to be associated with all-cause pneumonia ($p=1.1 \times 10^{-10}$, MAF cases = 0.09 vs MAF controls = 0.04, OR 2.3, 95% CI 1.8-2.9). Children with pneumonia who possessed the alternate allele, compared with those who had the reference, were more likely to have end-point consolidation on their chest x-ray ($p=0.0492$). 220 RNA samples from children with pneumonia were analysed. No cis eQTL were identified however, 230 significant trans eQTL to rs79755386 were identified with expression of HIC1 ($p=8.9 \times 10^{-5}$) which regulates T-cell differentiation, and SSH3 ($p=0.0001$) which plays a role in actin filament dynamics, having the most significant associations.

Conclusions/Learning Points: rs79755386 is associated with childhood pneumonia and the expression of genes which likely affect both immune and respiratory epithelial function. Further examination of the role rs79755386 plays in respiratory epithelium function is required.

LONGITUDINAL CYTOKINE ANALYSIS OF COVID-19 PREGNANT WOMEN AND THEIR INFANTS REVEALS PERSISTENTLY DYSREGULATED INFLAMMATORY RESPONSES

Oral Presentations Session

ORAL PRESENTATION SESSION 02: NEONATAL

Shira Cohen¹, Paula Rodriguez Molino¹, Zhaohui Xu¹, Maged Costantine², Kara Rood², Mahmoud Abdelwahab², Osvaldo Reyes^{3,4}, Rodrigo De Antonio^{4,5}, Xavier Sáez-Llorens^{4,5}, Sara Mertz¹, Fang Ye¹, Traci Pifer⁶, Manish Rijal⁶, Desiree Jones¹, Anna Bartholomew², Pablo Sanchez^{6,7,8}, Asuncion Mejias^{1,8}, Octavio Ramilo^{1,8}

¹Nationwide Children's Hospital, Center For Vaccines And Immunity, Columbus, United States of America, ²The Ohio State University, Departments Of Obstetrics And Gynecology, Columbus, United States of America, ³Saint Thomas Maternity Hospital, Department Of Obstetrics And Gynaecology, Panama City, Panama, ⁴Member of the Sistema Nacional de Investigadores de Panamá, Member Of The Sistema Nacional De Investigadores De Panamá, Panama City, Panama, ⁵Centro de Vacunación Internacional, Cevaxin, Panama City, Panama, ⁶Nationwide Children's Hospital, Center For Perinatal Research Division Of Neonatology And Pediatric Infectious Diseases, Columbus, United States of America, ⁷Nationwide Children's Hospital and Ohio State University College of Medicine, Divisions Of Neonatology, Department Of Pediatrics, Columbus, United States of America, ⁸Nationwide Children's Hospital and The Ohio State University, Division Of Pediatric Infectious Diseases, Columbus, United States of America

Backgrounds: COVID-19 is associated with adverse maternal outcomes and may affect infant immune development. There is a need to understand its impact on these unique populations. Our aim is to characterize the cytokine profiles in women with COVID-19 during pregnancy and their infants.

Methods: From August 2020–October 2021, pregnant women with (C19) and without COVID-19 (HC) and their infants were enrolled in a multicenter study. Blood samples were obtained at delivery, cord blood (CB), and at birth (<48 hours), 1 week, 1 month, and 2 months. Samples were analyzed using Olink inflammation panel and data with R software.

Results: We included 36 C19 mother-infant dyads (2 infected in 1st trimester, 11 in 2nd, and 23 in 3rd) and 17 HC. Compared with HC, C19 showed increased proinflammatory cytokines (IL6, IL17A) and growth factors (CSF1); and decreased cytokines related to apoptosis, migration, and chemotaxis (CD244, CXCL5, DNER) at delivery. Longitudinal analysis of CB and infants born to C19 and age-matched HC identified 17 cytokines that were significantly different and with variable trajectories over time: IL17C, IL1a, FGF21, 4EBP1, CCL20, CXCL11, SIRT2, STAMBP, ADA were increased in C19 CB, at birth and 1 week; while IL4, VEGFA, IL18 were decreased. FGF21, VEGFA, CCL19, CCL23, LIF, ARTN, NT3 were decreased at 1 and 2 months (Figure).

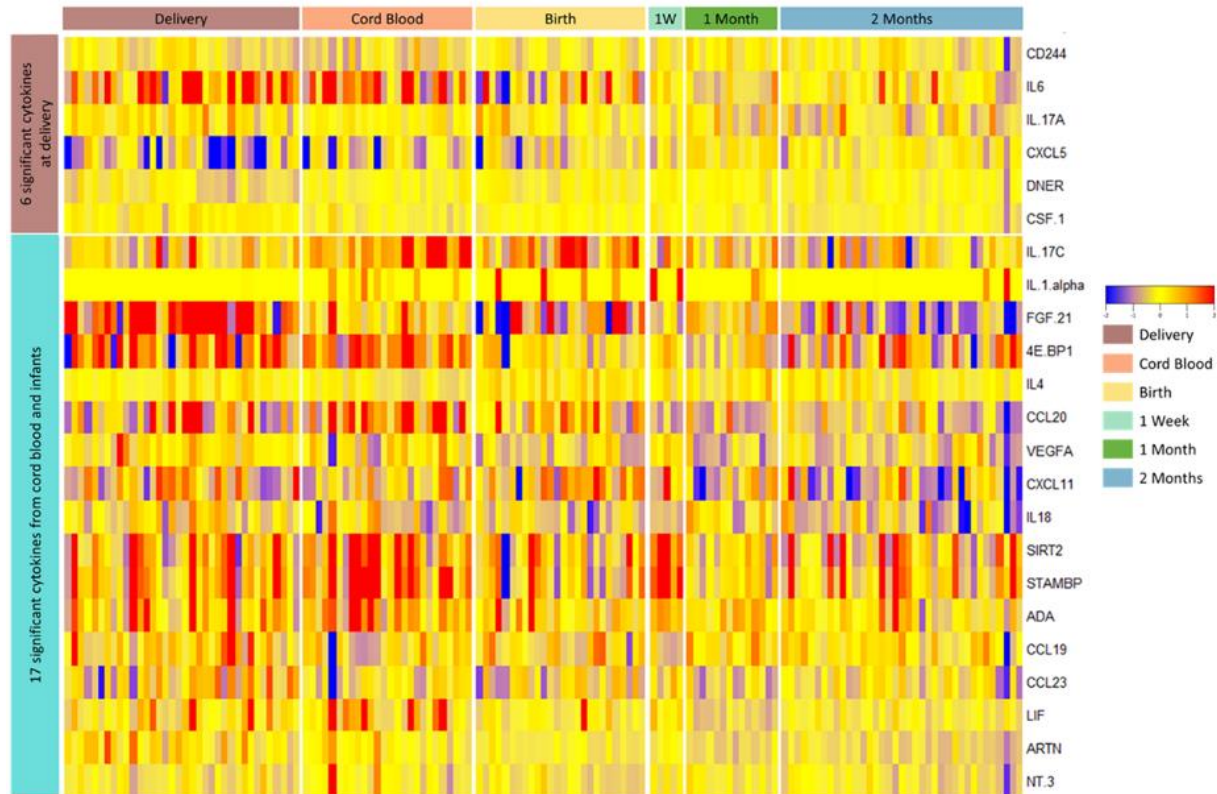

Figure: Significant differences in cytokine profiles were identified between COVID-19 infection during pregnancy (C19) and age-matched controls at sample timepoints: Mothers at delivery (brown), cord blood (orange), infants at birth (yellow), 1 week (light green), 1 month (green), and 2 months (blue). Data are displayed in a heatmap format where each column represents a patient and each row a statistically significant cytokine ($p < 0.05$) identified in a two-tailed Welch t -test between C19 and control groups. C19 cytokine data were normalized to the median of age-matched controls at each timepoint. Red indicates increased cytokine concentrations and blue indicates decreased concentrations compared to control in yellow.

Conclusions/Learning Points: We identified significantly different cytokine profiles in C19 compared with HC. COVID-19 during pregnancy induced distinct cytokine signatures in infants that persist at least until 2 months. Infant cytokine profiles exhibited different patterns than their mothers. These observations suggest that COVID-19 during pregnancy alters immunologic profiles of women and their infants and highlights the need for longitudinal studies to determine the long-term immunologic impact in both women and their children.

O009 / #674

LOW PARENTERAL GLUCOSE MODULATES IMMUNE-METABOLIC RESPONSES AND DECREASES SEPSIS SEVERITY IN INFECTED NEWBORN PRETERM PIGS

Oral Presentations Session

ORAL PRESENTATION SESSION 02: NEONATAL

Ole Bæk^{1,2}, Tik Muk¹, Ziyuan Wu¹, Duc Nguyen¹

¹Comparative Pediatrics and Nutrition, Department Of Veterinary And Animal Sciences, University Of Copenhagen, Denmark, Frederiksberg, Denmark, ²Clinic of Infectious Diseases, Department Of Internal Medicine, Herlev Hospital, Herlev, Denmark

Backgrounds: Preterm infants have impaired immunity and high susceptibility to neonatal sepsis, and often rely on parenteral nutrition (PN) rich in glucose. Using preterm pigs as models, we have shown that high PN glucose caused hyperglycemia and severe sepsis following neonatal infection, whereas glucose restriction prevented sepsis but induced severe hypoglycemia. Now we aimed to examine possibilities of PN glucose levels to lower sepsis risks without inducing hypoglycemia.

Methods: In two experiments with similar setups, caesarian section-delivered preterm pigs (90% gestation) were infused with *Staphylococcus epidermidis* or saline and nourished with PN for 22 h. Systemic metabolic and immunological response to infection were evaluated over time. In experiment 1, animals were kept on either high (21%, 30 g/kg/d, n=25) or low (5%, 7.2 g/kg/d, n=25) glucose PN until sacrifice. In experiment 2 all animals (n=41) were started on high glucose PN and 1/3 of animals were switched to low glucose PN after 3 and 6 hours, respectively.

Results: Experiment 1: Low parenteral glucose reduced mortality (25 vs 87%) and sepsis severity outcomes (higher blood pH, lower lactate and cytokines) while maintaining normoglycaemia. Proteomics and transcriptomics further revealed decreased inflammation and up-regulated anti-inflammatory apolipoproteins and complement proteins in blood, as well as decreased the hepatic Warburg effects (ratio of glycolysis/oxidative phosphorylation). Experiment 2: Switching from a high to a low glucose PN 3-6h post-infection did not change sepsis severity outcomes or mortality.

Conclusions/Learning Points: Low parenteral glucose decreased systemic glycolytic activity and the severity of sepsis outcomes, but switching from high to low glucose levels 3-6h post-infection had minimal impact on the clinical or immunological responses. This suggests systemic glucose conditions at the time of infection are key in guiding the immune-metabolic responses leading to sepsis.

0010 / #1043

A SINGLE HOST BIOMARKER COULD HELP IN REDUCING UNJUSTIFIED ANTIBIOTIC TREATMENTS IN HOSPITALIZED NEONATES

Oral Presentations Session

ORAL PRESENTATION SESSION 02: NEONATAL

Sylvie Pons¹, Sophie Trouillet-Assant^{1,2}, Fabien Subtil³, Elise Cornaton⁴, Sonia Galletti⁵, Amelie Berthiot⁵, Aurelie Cantais⁶, Stephanie Rapin⁶, Laurene Trapes⁶, Laurence Generenaz¹, Karen Brengel-Pesce¹, Olivier Claris^{4,7}, Aurelie Portefaix⁵, Cyril Flamant⁸, Marine Butin^{4,9}

¹Joint Unit, Hospices Civils De Lyon/biomérieux, Pierre Benite, France, ²VirPath ; CIRI ; INSERM U11 ; CNRS UMR5308 ; ENS Lyon, Université Claude Bernard Lyon 1, Lyon, France, ³Hospices civils de Lyon, Biostatistics, Lyon, France, ⁴Hospices civils de Lyon-HFME, Neonatology, Bron, France, ⁵Hospices civils de Lyon, Centre D'investigation Clinique 1407 Inserm, Umr 5558, Lbbe, Cnrs, Bron, France, ⁶University Hospital of Saint Etienne, Neonatology, Saint Etienne, France, ⁷EA 4129, Université Claude Bernard, Villeurbanne, France, ⁸CHU de Nantes Hopital mère enfants, Service De Réanimation Et Médecine Néonatales, Nantes, France, ⁹CIRI ; INSERM U11 ; CNRS UMR5308 ; ENS Lyon, Université Claude Bernard Lyon 1, Lyon, France

Backgrounds: Late-onset neonatal sepsis (LOS) is frequently observed in Neonatal Intensive Care Units (NICUs) and potentially severe. Despite its high prevalence, diagnostic remains difficult. Biological markers (CRP and PCT) had low performance at LOS onset. Blood culture results are too late and lack sensitivity. These difficulties lead to antibiotic overuse in hospitalized newborns, resulting in an increased antibiotic resistance, microbiota modification, neonatal complications. Our aim was to identify a biomarker combination to early exclude the diagnosis of LOS in newborn with suggestive clinical signs.

Methods: We conducted a prospective, multicenter cohort study (EMERAUDE) (NCT03299751). Hospitalized preterm neonates of at least 7 days with signs of suspected LOS were enrolled. Serum samples were collected at the time of the venipuncture prescribed for standard care. We assessed the performance of 11 protein markers using Simple Plex™ technology (Protein simple©, CA, USA). An adjudication committee, assigned each patient to one category among “confirmed infection”, “infirm infection” or “undetermined infection”.

Results: 234 patients were enrolled and 230 had analyzable samples. The patients were mainly preterm (80%) with a median gestational age of 27 weeks, a median birth weight of 940 grams. 22% had a confirmed infection and all of them received antibiotics. Among the infirm infection group, 27% received antibiotics. Among all analysed biomarkers IL10 had the best performance, with an area under the curve [IC95%] of 0.845[0.777-0.914]. Using optimal threshold value, we highlighted that more than a half of unjustified antibiotics in non-infected neonates could be avoided.

Conclusions/Learning Points: At the onset of clinical suspicion of LOS, additional biomarkers could help the clinician in its choice of prescribing or not antibiotics. Validation studies will be performed to assess the interest of IL10 biomarker in a clinical decision rule.

O011 / #1075

A REVIEW OF LUMBAR PUNCTURES PERFORMED FOR EARLY ONSET NEONATAL SEPSIS IN NEONATES OF 35 WEEKS GESTATION OR GREATER IN A TERTIARY NEONATAL UNIT BETWEEN 2016 AND 2020

Oral Presentations Session

ORAL PRESENTATION SESSION 02: NEONATAL

Sean Whelan, Darren Buckley, Liam O'Connell

Cork University Maternity Hospital, Department Of Neonatology, Cork, Ireland

Backgrounds: Early onset sepsis (EOS) is a diagnostically challenging clinical concern in neonatology. We sought to ascertain the incidence of EOS in our unit, and to examine the role of lumbar puncture (LP) in EOS evaluation, including the use of CRP as an indication.

Methods: A retrospective electronic chart review of neonates who were born in CUMH at greater than 35 weeks gestational age from 01/01/2016-31/12/2020 who underwent a LP due to concern for EOS.

Neonates were identified based on electronic chart pharmacy records of receiving 3+ days of IV benzylpenicillin or cefotaxime, correlated with laboratory reports for LP.

Results: 676 neonates were treated for greater than 3 days with intravenous antibiotics due to concern for EOS (23/1000). 205 LPs were undertaken (7/1000). In 41 cases (20%) CSF was either not obtained, or was too bloodstained for microscopy. 18 neonates had proven bacteraemia (0.62/1000). There were 6 cases of culture/PCR negative CSF with a high cell count concerning for ventriculitis and 1 case of culture positive group B streptococcus meningitis in the setting of bacteraemia with the same organism. The incidence of confirmed or suspected bacterial meningitis was 0.24/1000.

Conclusions/Learning Points: In neonates without bacteraemia or signs of meningism, none had suspected or confirmed bacterial meningitis with a pre-LP CRP less than 45 or a maximum CRP less than 50. The relative rarity of neonatal meningitis precludes definitive threshold definition by this study. However using higher CRP thresholds of 40 versus 20 in neonates without other indications for LP in this cohort would have prevented 34 LPs without missing a case of ventriculitis/meningitis. A sizable cohort (20%) in whom LP was felt indicated had failed or entirely bloodstained CSF collection, challenging diagnosis.

COMPARISON OF HUMAN CYTOMEGALOVIRUS (HCMV)-ENZYME-LINKED IMMUNE ABSORBENT SPOT (ELISPOT) AND CMV-QUANTIFERON CELL-MEDIATED IMMUNE ASSAY SERIAL MEASUREMENTS, IN HCMV-SEROPOSITIVE PREGNANT WOMEN IN SOUTH LONDON, ENGLAND

Oral Presentations Session

ORAL PRESENTATION SESSION 02: NEONATAL

Shari Sapuan¹, Ngeekeong Tan², David Carrington², Vanessa Greening¹, Christine Jones^{1,3,4}, Robin Parsons¹, Cassie Pope², Blair Strang⁵, Paul Heath¹

¹St George's, University of London, Paediatric Infectious Diseases Research Group, London, United Kingdom, ²St George's University Hospitals NHS Foundation Trust, Medical Microbiology, London, United Kingdom, ³University of Southampton, Faculty Of Medicine And Institute For Life Sciences, Southampton, United Kingdom, ⁴University Hospital Southampton NHS Foundation Trust, Nih Southamton Clinical Research Facility And Nih Southamton Biomedical Research Centre, Southampton, United Kingdom, ⁵St George's, University of London, Infection And Immunity Research Institute, London, United Kingdom

Backgrounds: HCMV-specific cell-mediated immunity (CMI) is essential in the control of viral replication to prevent end-organ HCMV disease. HCMV-specific interferon gamma release assays, such as HCMV-ELISPOT and HCMV-QuantIFERON, have been used to measure HCMV-specific CMI. In pregnant women, the role of HCMV-specific CMI in controlling viral replication and transmission to the foetus have not been fully investigated. We aimed to perform serial HCMV-ELISPOT and HCMV-QuantIFERON measurements in HCMV-seropositive women during pregnancy.

Methods: HCMV-seropositive pregnant women receiving antenatal care at a tertiary hospital in London (UK) were enrolled. Blood samples were collected at three time-points in pregnancy and a fourth time-point after delivery, and HCMV-ELISPOT and HCMV-QuantIFERON assays were performed on these samples. HCMV-ELISPOT was recorded as responsive or non-responsive, as a spot count, and as specific spot counts to IE-1 and pp65 antigens. HCMV-QuantIFERON was recorded as positive or negative.

Results: From 67 HCMV-seropositive pregnant women, 105 blood samples were tested with both assays. All women had a responsive HCMV-ELISPOT result on at least one time-point, and 70% (47/67) of women had a positive HCMV-QuantIFERON result on at least one time-point. The two assays showed no overall agreement (Cohen's Kappa 0.032), although the overall mean HCMV-ELISPOT spot counts to IE-1 and pp65 antigens were higher when HCMV-QuantIFERON was positive than when it was negative (Figure 1).

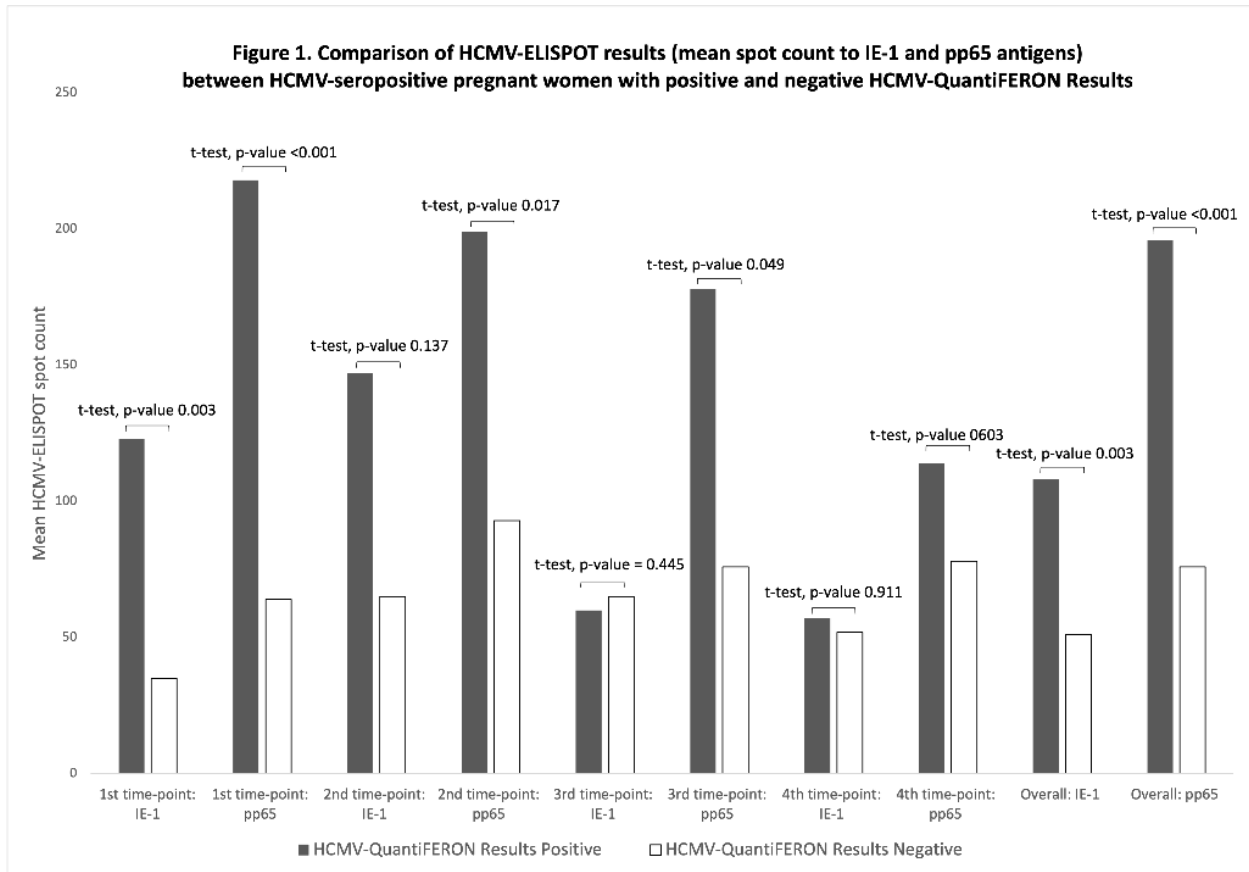

Conclusions/Learning Points: In this cohort, the HCMV-ELISPOT assay was more likely than the HCMV-QuantiferON assay to detect HCMV-specific CMI in HCMV-seropositive pregnant women. This may have implications for optimal CMI monitoring in this important population.

O013 / #1057

HERPES SIMPLEX VIRUS IN INFANTS UNDER 90 DAYS OF AGE: INTERIM RESULTS OF THE 2019-2021 BRITISH PAEDIATRIC SURVEILLANCE UNIT (BPSU) STUDY

Oral Presentations Session

ORAL PRESENTATION SESSION 02: NEONATAL

Julia Dudley¹, Paul Heath², Georgina Yan³, Shamez Ladhani², Katy Fidler³

¹Royal Alexandra Children's Hospital, Academic Department Of Paediatrics, Brighton, United Kingdom, ²St George's, University of London, Paediatric Infectious Diseases Research Group, London, United Kingdom, ³Royal Alexandra Children's Hospital, Paediatrics, Brighton, United Kingdom

Backgrounds: Neonatal herpes simplex virus (HSV) infection is a rare but dangerous condition. A recent study suggests that the UK incidence may have increased since the last national surveillance study in 2007. Rising numbers of cases may support the wider use of empirical treatment. Postnatal transmission is thought to account for ~10% of cases. More information about this disease is required to inform future prevention and treatment strategies.

Methods: Analysis of questionnaires completed for the current British Paediatric Surveillance Unit neonatal HSV study was conducted. Semi-anonymised patient identifiers allow removal of duplicate cases. The study was extended from 25 months to 30 months to capture additional data on changing trends during the COVID-19 pandemic. Interim results are reported here.

Results: 228 cases were notified July 19 - Dec 2021. 159 questionnaires were completed and basic data on 111 cases was available after duplications and incomplete records were removed. 29.7% were premature, 26.1% died. Full data analysed on the first 80 cases (July 19-April 21) show: 27.0% were premature, 26.9% had disseminated disease and mortality was 71.0% in disseminated disease. 23.8% of babies with disseminated disease had no fever at presentation. Treatment was delayed by more than one day in 60%. Case notifications reduced during UK lockdown periods.

Conclusions/Learning Points: UK incidence of neonatal HSV disease has increased since the last BPSU study. Mortality remains high and presenting features are non-specific. Absence of fever at presentation demonstrates that HSV should not only be considered in febrile infants. Falling numbers of reported cases during periods of social distancing and strict public hygiene measures may highlight the importance of postnatal transmission. Follow-up focusing on disease recurrence and long-term complications at 12 and 24 months is ongoing.

HYPER INFLAMMATORY SYNDROME FOLLOWING COVID-19 MRNA VACCINE IN CHILDREN: A NATIONAL POST-AUTHORIZATION PHARMACOVIGILANCE STUDY

Oral Presentations Session

ORAL PRESENTATION SESSION 03: COVID-19 SESSION I

Naim Ouldali¹, Haleh Bagheri², Francesco Salvo³, Denise Antona⁴, Antoine Pariente³, Claire Leblanc⁵, Martine Tebacher⁶, Joelle Micallef⁷, Corinne Levy⁸, Robert Cohen⁸, Etienne Javouhey⁹, Brigitte Bader-Meunier¹⁰, Caroline Ovaert¹¹, Sylvain Renolleau¹², Veronique Hengten¹³, Isabelle Kone-Pault¹⁴, Nina Deschamps¹⁵, Loic De Pontual¹⁶, Xavier Iriart¹⁷, Christèle Gras-Leguen¹⁸, Francois Angoulvant¹⁹, Alexandre Belot²⁰

¹Sainte Justine hospital, Infectious Diseases, Montréal, Canada, ²Toulouse University hospital, Pharmacovigilance Center, Toulouse, France, ³Bordeaux University, Pharmacovigilance Center, Bordeaux, France, ⁴Public health France, Infectious Diseases, Paris, France, ⁵Robert Debré hospital, Pediatric Infectious Diseases, Paris, France, ⁶Strasbourg University, Pharmacovigilance Center, Strasbourg, France, ⁷Marseille University, Pharmacovigilance Center, Marseille, France, ⁸ACTIV, Paediatrics, Créteil, France, ⁹Hospices Civils de Lyon - Hopital Femme Mere Enfant, Service De Reanimation Et Urgences Pédiatriques, Bron, France, ¹⁰Necker hospital, Rheumatology, Paris, France, ¹¹Marseille University, Pediatric Cradiology, Marseille, France, ¹²Hopital Nceker-Enfants Malades, Pediatric Intensive Care Unit, Paris, France, ¹³Versailles hospital, Paediatrics, Versailles, France, ¹⁴Kremlin Bicetre hospital, Rheumatology, Kremlin Bicetre, France, ¹⁵Saint Malo, Paediatrics, Saint Malo, France, ¹⁶Jean Verdier hospital, Paediatrics, Bondy, France, ¹⁷Bordeaux University, Pediatric Cradiology, Bordeaux, France, ¹⁸Nantes University Hospital, Paediatrics, Nantes, France, ¹⁹Hopital universitaire Robert Debré, Pediatric Infectious Diseases And Internal Medicine, Paris, France, ²⁰CHU Lyon, Pediatric Nephrology Rheumatology And Dermatology, Lyon, France

Backgrounds: Multisystem inflammatory syndrome in children (MIS-C) is the most severe clinical entity associated with pediatric SARS-CoV-2 infection with a putative role of the spike protein into the immune system activation. Whether COVID-19 mRNA vaccine can induce this complication in children is unknown. We aimed to assess the risk of hyper-inflammatory syndrome following COVID-19 mRNA vaccine in children.

Methods:: We conducted a post-authorization national population-based surveillance using the French enhanced pharmacovigilance system for COVID-19 vaccines. All cases of suspected hyper-inflammatory syndrome following COVID-19 mRNA vaccine in 12–17-year-old children between June 15th, 2021 and January 1st, 2022, were reported. The reporting rate of this syndrome was compared to the MIS-C rate per 1,000,000 12–17-year-old children infected by SARS-CoV-2.

Results: Up to January 2022, 8,113,058 COVID-19 mRNA vaccine doses were administered to 4,079,234 12–17-year-old children. Among them, 12 presented a hyper-inflammatory syndrome with multisystemic involvement. Main clinical features included male predominance (10/12, 83%), cardiac involvement (10/12, 83%), digestive symptoms (10/12, 83%), coagulopathy (7/12, 58%), cytolytic hepatitis (6/12, 50%), and shock (5/12, 42%). 4/12 (33%) required intensive care unit transfer, and 3/12 (25%) hemodynamic support. All cases recovered. In eight cases, no evidence of previous SARS-CoV-2 infection was found. The reporting rate was 1.5 (95%CI [0.8; 2.6]) per 1,000,000 doses injected, i.e. 2.9 (95%CI [1.5; 5.1]) per 1,000,000 12–17-year-old vaccinated children. As a comparison, 113 MIS-C (95%CI [95; 135]) occurred per 1,000,000 12–17-year-old children infected by SARS-CoV-2.

Conclusions/Learning Points: Very few cases of hyper-inflammatory syndrome with multi-organ involvement occurred following COVID-19 mRNA vaccine in 12–17-year-old children. The low reporting rate of this syndrome, compared to the rate of post-SARS-CoV-2 MIS-C in the same age-group, largely supports the vaccination in a context of an important circulation of SARS-CoV-2.

O015 / #1914

CLINICAL AND SEROLOGICAL DATA OF NEONATES BORN TO WOMEN WITH SARS-COV-2 INFECTION IN PREGNANCY

Oral Presentations Session

ORAL PRESENTATION SESSION 03: COVID-19 SESSION I

Concetta Marsico¹, Liliana Gabrielli², Caterina Vocale³, Tiziana Lazzarotto⁴, Santo Arcuri⁵, Luigi Corvaglia⁵, Maria Grazia Capretti¹

¹IRCCS Azienda Ospedaliero Universitaria di Bologna, Neonatal Intensive Care Unit, Bologna, Italy, ²IRCCS Azienda Ospedaliero Universitaria di Bologna, Microbiology Unit, Bologna, Italy, ³IRCCS Azienda Ospedaliero Universitaria di Bologna, Microbiology Unit, Regional Reference Center For Microbiological Emergencies (crrem), Bologna, Italy, ⁴IRCCS Azienda Ospedaliero Universitaria di Bologna, Microbiology Unit, Department of Specialized, Experimental And Diagnostic Medicine, University Of Bologna, Bologna, Italy, ⁵IRCCS Azienda Ospedaliero Universitaria di Bologna, Neonatal Intensive Care Unit, Department Of Medical And Surgical Sciences, University Of Bologna, Bologna, Italy

Backgrounds: To evaluate the outcomes of neonates exposed to SARS-CoV-2 in pregnancy, the dynamics of maternal IgG placental transfer and its persistence during the first months of life.

Methods: Prospective study enrolling neonates born to mothers with SARS-CoV-2 infection in pregnancy at IRCCS Azienda Ospedaliero Universitaria di Bologna, Italy, between March 2020 and September 2021. Neonates born to women with peripartum infection were excluded. All infants were enrolled in a 12-month follow-up. Quantitative IgG to S1/S2 subunits of spike protein were assessed in mother-neonates dyads within 48 hours post-delivery and during follow-up until negative. Transplacental IgG transfer ratio in relation to the trimester of maternal infection was assessed.

Results: One hundred and forty neonates were included. No clinical, laboratory and cerebral abnormalities were detected at birth or during follow-up, until a median age of 11 months (range 6-12). Median SARS-CoV-2 S1/S2 IgG level at birth was 22 AU/mL (IQR 11-52.5) for neonates and 35 AU/mL (IQR 19-62.5) for mothers. Median IgG level at birth was not different between neonates born to asymptomatic or symptomatic mothers (18 AU/mL, IQR 9-49, versus 23.5 AU/mL, IQR 11-61.7, P=0.26) and was not different in relation to trimester of maternal infection (P= 0.9). Transplacental transfer ratio was higher following second trimester maternal infections (0.99±0.45 versus 1.05±0.61 versus 0.74±0.43, P=0.02). Maternally derived IgG were rapidly weaned: all infants had no detectable antibodies within 8 months of life.

Conclusions/Learning Points: Neonatal and long-term outcomes of infants SARS-CoV-2 exposed in utero in all trimesters of gestation were favorable. IgG transplacental transfer was higher following second trimester maternal infections, which could be relevant to inform studies on appropriate vaccination strategies. All infants lost maternal antibodies within 8 months of life.

O016 / #1857

LOWER RISK OF MULTISYSTEM INFLAMMATORY SYNDROME IN CHILDREN (MIC-S) WITH THE DELTA VARIANT OF SARS-COV-2

Oral Presentations Session

ORAL PRESENTATION SESSION 03: COVID-19 SESSION I

Jonathan Cohen¹, Michael Carter², Ronny Cheung³, Shamez Ladhani⁴

¹Evelina London Children's Hospital, Department Of Paediatric Infectious Diseases And Immunology, London, United Kingdom, ²King's College London, School Of Life Course And Population Sciences, London, United Kingdom, ³Evelina London Children's Hospital, General Paediatrics, London, United Kingdom, ⁴UK Health Security Agency, Immunisation Division, London, United Kingdom

Backgrounds: Multisystem Inflammatory Syndrome in Children (MIS-C, also known as PIMS-TS) typically occurs 2-6 weeks after exposure to SARS-CoV-2. Early estimates suggested a risk of MIS-C of 1 in 3-4000 infected children. Whether this risk is sustained with new SARS-CoV-2 variants remains unknown.

Methods:: We utilised prospective data from the NHS South Thames Paediatric Network (STPN), which manages all cases of MIS-C amongst 1.5 million children in South-East England, to assess trends over time. We compared MIS-C cases with two independent SARS-CoV-2 infection datasets. We used publicly available UK Health Security Agency case numbers weighted to child population distributions according to area population estimates from the Office for National Statistics (ONS). To avoid bias due to evolving testing behaviour, we also compared MIS-C cases to community infection rates, obtained from the ONS COVID-19 Infection Survey, which randomly selects individuals for fortnightly PCR tests. All three datasets were normalised to the peak of the Alpha wave, and plotted against time. MIS-C cases were plotted 40 days prior to hospitalisation, corresponding to the best fit of rising SARS-CoV-2 infection and MIS-C cases during the Alpha wave.

Results: Compared with the Alpha wave, we found fewer cases of MIS-C relative to SARS-CoV-2 infections during both initial and subsequent Delta waves. This relative reduction continued into the Omicron wave.

Conclusions/Learning Points: Re-infection rates with the Alpha or Delta variants and vaccination rates were very low during the Delta wave. As a result, lower MIS-C rate relative to SARS-CoV-2 infections during the Delta wave is unlikely to be explained by population level immunity from prior infection or vaccination. It is most likely due to viral mutations in key antigenic epitopes responsible for triggering the hyperinflammatory response observed with MIS-C.

O017 / #1934

NO EVIDENCE OF AUTO-ANTIBODY BINDING TO CARDIAC TISSUE IN MIS-C AND COVID-19 VACCINATION INDUCED CARDIOMYOPATHY

Oral Presentations Session

ORAL PRESENTATION SESSION 03: COVID-19 SESSION I

Harsita Patel¹, Amalia Sintou², Rasheeda A Chowdhury², Alma-Octavia Iacob², Stephen Rothery², Sanjay Prasad², Chisato Shimizu³, Kirsten Drummer³, Adriana Tremoulet³, Jane Burns³, Susanne Sattler², Michael Levin¹

¹Imperial College London, Infectious Disease, London, United Kingdom, ²Imperial College London, National Heart And Lung Institute, NN, United Kingdom, ³Rady Children's Hospital and University of California San Diego, Department Of Pediatrics, San Diego, United States of America

Backgrounds: Cardiomyopathy is one of the significant features of SARS-CoV-2 induced multi-system inflammatory syndrome in children (MIS-C) and it is also a rare complication of mRNA COVID-19 vaccination in young adults. MIS-C occurs 4-6 weeks following SARS-CoV-2 infection; we therefore postulated that antibodies might play a role in the cardiac immunopathology. The mechanism of vaccine-induced myocarditis is currently being explored. We investigated the role of anti-cardiac antibodies in post SARS-CoV-2 vaccine myocarditis and MIS-C.

Methods:: Clinical cohort: Pre-treatment acute MIS-C (n=10), acute COVID-19 vaccination-induced myocarditis (n=10), Pre-COVID-19 pandemic healthy children (n=10) and healthy COVID-19 vaccinated adults (10). Immunohistochemistry was performed on human left ventricular tissue sections from 2 donor hearts (deemed unsuitable for donation) for assessment of auto-antibody binding. Sera from patients and controls were used as primary antibodies. FITC-conjugated anti-human-IgG (1:150), IgM (1:150) and IgA (1:50) were used for detection. 10 images were taken at random from each section and immunoglobulin deposition was quantified by calculating mean fluorescent intensity using ImageJ/Fiji. This method has previously shown specific binding of IgG to cardiac tissue following treatment with serum obtained from an adult myocarditis patient.

Results: No specific binding was seen in left ventricular tissue treated with sera from paediatric patients with either MIS-C or COVID-19 vaccine-induced myocarditis. There was no significant difference in the mean fluorescent intensity of IgG, IgM and IgA in patients compared to controls (Figure

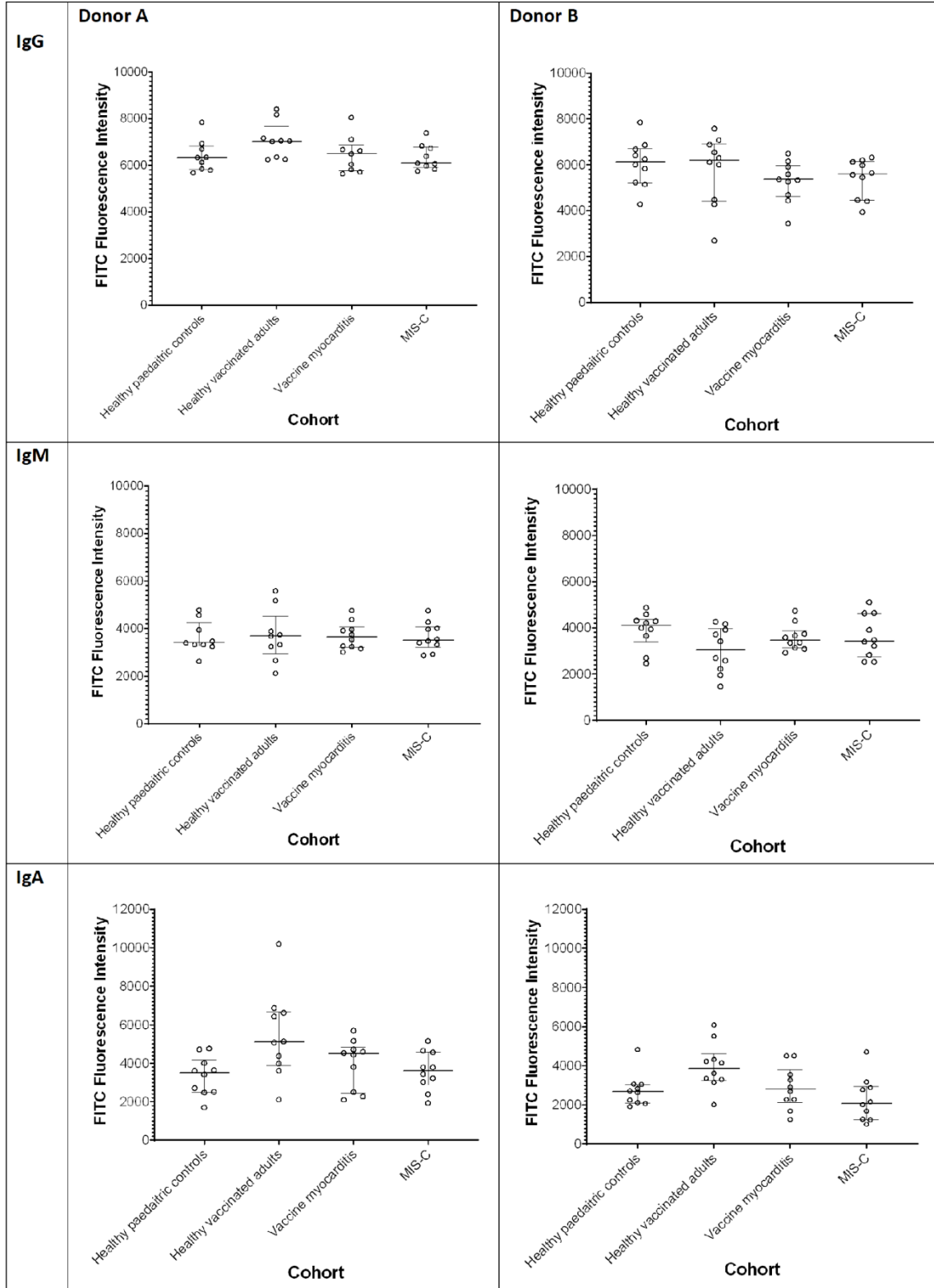

Figure 1. Fluorescence intensity of FITC conjugated with anti-human IgG, IgM and IgA measured in cardiac tissue of 2 healthy donors (A & B) following treatment with sera from different cohorts (healthy pre-pandemic paediatric controls (n=10), healthy COVID-19 vaccinated adults (n=10), COVID-19 vaccine myocarditis and Multisystem Inflammatory Syndrome in Children (MIS-C) (n=10) at 1:50

1).

Conclusions/Learning Points: Our study did not find evidence for a role of an anti-cardiac antibody-mediated inflammatory process in MIS-C cardiomyopathy and COVID-19 vaccine induced myocarditis.

O018 / #1825

MILD COVID-19 INFECTION GENERATES DURABLE ANTIBODY RESPONSES IN UNVACCINATED CHILDREN

Oral Presentations Session

ORAL PRESENTATION SESSION 03: COVID-19 SESSION I

Manu Chhabra¹, Alicia Kang², Bee Leng Kee², Rie Aoyama², Elizabeth Tham^{1,2}, Si Min Chan^{1,2}

¹National University Health System, Singapore, Khoo Teck Puat-national University Children's Medical Institute, Singapore, Singapore, ²National University Singapore Yong Loo Lin School of Medicine, Department Of Paediatrics, Singapore, Singapore

Backgrounds: Antibody titres decline in the months following COVID-19 in adults. COVID-19 is typically milder in children and there is limited data on durability of humoral responses following natural infection in this cohort.

Methods:: Children aged ≤ 17 years old with SARS-CoV-2 infection diagnosed by RT-PCR at our centre were recruited between January and July 2021. Subjects underwent serological testing for anti-Spike and anti-N-capsid Immunoglobulin G (IgG) antibodies at time of diagnosis. Subjects underwent point of care testing (POCT) (ASSURE® SARS-CoV-2 IgG/IgM Rapid Test) for total SARS-CoV-2 IgG at 0-6 weeks post diagnosis. POCT testing was repeated with serological testing and testing for SARS-CoV-2 neutralising antibodies (cPASS™ assay) at 3-6 months, 12 months, and 24 months post-diagnosis. Subjects were allowed to be recruited into the study at any timepoint.

Results: The results summarise preliminary data for 23 children. Median age of the cohort was 5.9 years (range 8 months -17 years). None were immunosuppressed or had significant co-morbidities. 21 children had a positive household contact. 12 children were asymptomatic at time of diagnosis; all eventually had asymptomatic or mild disease. There were no cases of multisystem inflammatory syndrome in children, or re-infection in the child or their household contacts. 7/18 (39%) children were already seropositive at time of diagnosis on serology testing. On POCT, at 0-6 weeks, 5/6 (83%) children were seropositive; seropositivity persisted in all children at 3-6 months (n=8) and in 5/6 (83%) children at 12 months (figure 1). The study of temporal kinetics for anti-Spike and anti-N-capsid IgG antibodies, and neutralising antibody titres is still ongoing.

Patients positive for anti-SARS-CoV2-IgG

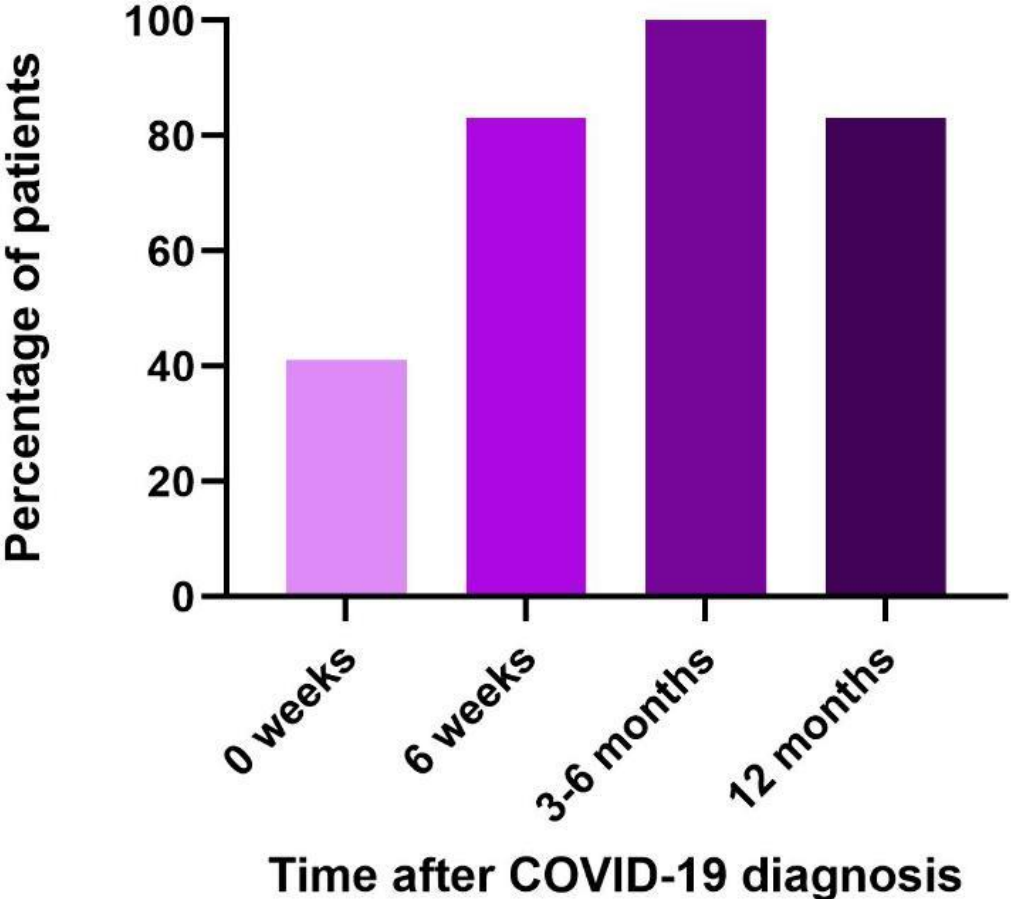

Conclusions/Learning Points: Even mild COVID-19 infection induces durable seroconversion in children with detectable IgG levels at 1 year after infection in the majority.

ANTIBODY KINETICS AND CLINICAL OUTCOMES IN A COHORT OF INFANTS BORN FROM MOTHERS WITH SARS-COV-2 INFECTION DURING PREGNANCY (CORONASCOPE STUDY)

Oral Presentations Session

ORAL PRESENTATION SESSION 03: COVID-19 SESSION I

Jaime Carrasco¹, [Angela Manzanares](#)², Alicia Álvaro Gómez³, Isabel Serrano³, Estrella Esquivel⁴, José Alfredo Pérez-Rivilla⁵, María Teresa Moral Pumarega⁶, Elisa Aguirre Pascual⁷, Joaquin De Vergas⁸, Ignacio Herrainz⁹, Cinta Moraleda², Cristina Epalza², Elisa Fernandez-Cooke², Luis Prieto², Serena Villaverde², Berta Zamora¹⁰, Alberto Galindo⁹, María Dolores Folgueira⁵, Rafael Delgado⁵, Daniel Blázquez-Gamero¹¹

¹HOSPITAL SON ESPASES, Paediatrics, PALMA DE MALLORCA, Spain, ²Hospital 12 de Octubre, Pediatric Infectious Disease Unit, Madrid, Spain, ³Universidad Complutense, Pediatrics, Madrid, Spain, ⁴Instituto de Investigación Hospital 12 de octubre, ., Madrid, Spain, ⁵Hospital 12 de Octubre, Microbiology Department, Madrid, Spain, ⁶Hospital 12 de Octubre, Neonatology Department, Madrid, Spain, ⁷Hospital 12 de Octubre, Radiology Department, Madrid, Spain, ⁸Hospital 12 de Octubre, Otorhinolaryngology Department, Madrid, Spain, ⁹Hospital 12 de Octubre, Obstetrics Department, Madrid, Spain, ¹⁰Hospital 12 de Octubre, Neuropsychology Unit, Madrid, Spain, ¹¹Hospital Universitario 12 de Octubre, Pediatric Infectious Diseases Unit. Department Of Pediatrics, Madrid, Spain

Backgrounds: We aim to describe outcomes (focusing on hearing and neurological findings) and transfer of maternal antibodies in infants born from mothers with SARS-CoV-2 infection during pregnancy.

Methods:: Observational prospective study performed in a tertiary hospital in Madrid (Spain). Infants born from mothers with SARS CoV-2 infection during pregnancy from March to September 2020 were included. SARS-CoV-2 RT-PCT on nasopharyngeal swab (NPS) was performed at birth to infants born from mother with acute infection at delivery. A follow-up visit with physical and neurological examination, SARS-CoV-2 RT-PCR on NPS, SARS-CoV-2 serology, and a cranial ultrasound (cUS) was performed within 3 months of life. Automated auditory brainstem response (A-ABR) exams were performed at birth, and auditory steady-state response (ASSR) at six months of life.

Results: 95 infants born from 94 mothers were included. Median gestational age was 39+3 (IQR 38-40) and 10 (10.5%) were preterm. Thirteen (13.7%) newborns required hospital admission after birth, none of them with a COVID-19 infection. Rates of vertical (1/28; 3.6%) and horizontal (1/93; 1.1%) transmitted infections were low, with mild symptoms. In follow-up visit, neurological examination was normal in all infants. Cranial ultrasound was normal in 81/85 (95.3%) infants, with mild abnormalities in four infants. 47/95 (50%) infants had a positive serology. Serology result was not related to the severity of the maternal infection, skin-to-skin care at birth or breastfeeding. There was a progressive decrease in SARS-CoV-2 antibody titers with the age (figure 1). No hearing loss was detected.

Figure 1. Relation of antibody results and titters with days of life.

Figure 1a.

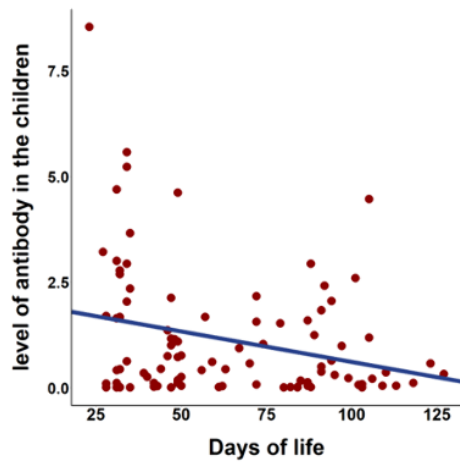
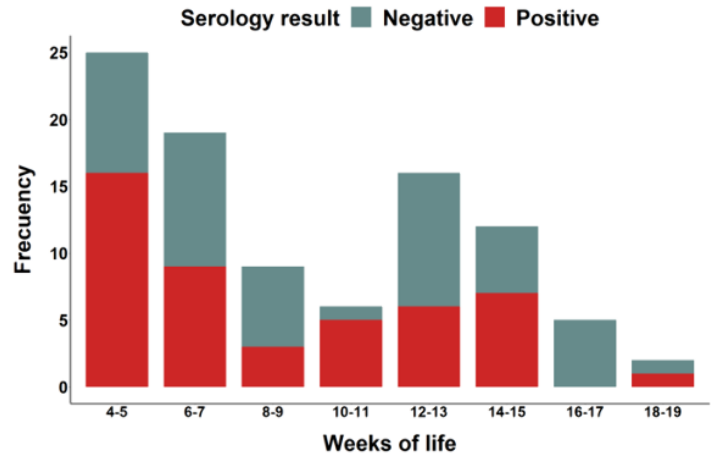

Figure 1b.



1a. Relation of antibodies titters and days of life. For an increase in one day of life, a 0.014 (-0.02-0) reduction in antibodies titters is expected with a statistical significance (P=0.008).

1b. Number of serologies done, with a negative (grey) and a positive (red) result, divided according to weeks of life of the infants at the follow-up visit.

Conclusions/Learning Points: In this cohort, most infants born from mothers with SARS-CoV-2 infection during pregnancy had normal cUS, hearing screening and neurological examinations in the follow-up. There is a rapid decrease in transferred maternal antibodies in the first months of life.

THE WANING OF MATERNAL MEASLES ANTIBODIES: A MULTI-COUNTRY MATERNAL-INFANT SEROPREVALENCE STUDY

Oral Presentations Session

ORAL PRESENTATION SESSION 04: VACCINES

Karen Tiley¹, Hinke Ten Hulscher-Van Overbeek², Patrick Ansah³, Rob Van Binnendijk², Ed Clarke⁴, Carmen Contreras⁵, Stephen Cose⁶, Ha Thi Thu Hoang⁷, Beth Holder⁸, Olubukola Idoko⁴, Beate Kampmann⁹, Abdul Kazi¹⁰, Fiona Van Der Klis², Elke Leuridan¹¹, Kirsten Maertens¹¹, Herberth Maldonado⁵, Saad Omer¹², Marcela Pasetti¹³, Nynke Rots², Milagritos Tapia¹³, Nasamon Wanlapakorn¹⁴, Merryn Voysey¹

¹University of Oxford, Oxford Vaccine Group, Oxford, United Kingdom, ²National Institute for Public Health and the Environment, RIVM, Bilthoven, Netherlands, ³Navrongo Health Research Centre, Navrongo, Navrongo, Ghana, ⁴MRC Unit, The Gambia, LSHTM, London, United Kingdom, ⁵Universidad del Valle de Guatemala, Centro De Estudios En Salud, Guatemala City, Guatemala, ⁶LSHTM, MRC Uganda Virus Research Institute, London, United Kingdom, ⁷National Institute for Hygiene and Tropical Medicine, Hanoi, Viet Nam, ⁸Imperial College, Institute Of Reproductive Biology, London, United Kingdom, ⁹LSHTM, Department Of Clinical Research, London, United Kingdom, ¹⁰The Aga Khan University, Department Of Pediatrics And Child Health, Karachi, Pakistan, ¹¹University of Antwerp, Centre For The Evaluation Of Vaccination, Vaccine & Infectious Diseases Institute, Antwerp, Belgium, ¹²Yale School of Public Health, Yale Institute For Global Health, New Haven, United States of America, ¹³University of Maryland, School Of Medicine, Baltimore, United States of America, ¹⁴Chulalongkorn University, Department Of Pediatrics, Bangkok, Thailand

Backgrounds: The presence of maternal transplacental measles antibodies in infants can prevent infection in early life but also suppress the infant response to the first measles vaccine.

Methods: We explored factors associated with antibody levels in mothers and infants at birth, and the decay of antibody in the first year of life in a multicountry seroprevalence study to determine the decay of maternal antibodies and loss of protection, and whether these vary geographically. Stored sera from mothers and infants were shipped to a central laboratory for evaluation of anti-measles IgG by multiplex immunoassay and plaque reduction neutralisation titres (PRNT). Data from the first five countries were available for analysis (Mali, Thailand, The Netherlands, UK, Vietnam) Log-transformed data were compared using linear models adjusting for country. Decay models included polynomial terms and infant level random intercepts to account for the repeated timepoints.

Results: Higher measles serum IgG and PRNT were statistically associated with maternal age, in both maternal samples (IgG $p=0.001$, PRN $p=0.003$) and cord blood (IgG $p=0.037$, PRN $p=0.015$). Maternal age was also statistically significantly related to the WHO measles vaccine coverage during the mother's year of birth, indicating that older mothers are less likely to have been vaccinated in early life than younger mothers resulting in higher antibody in later life from childhood infection. Measles IgG and PRNT in infant samples decayed at a similar rate across all countries in the first 6 months of life. Average PRNT were below protective thresholds (120 mIU/ml) by 6 months of age for all countries. For anti-measles IgG, all countries had seronegative estimates at 9 months of age.

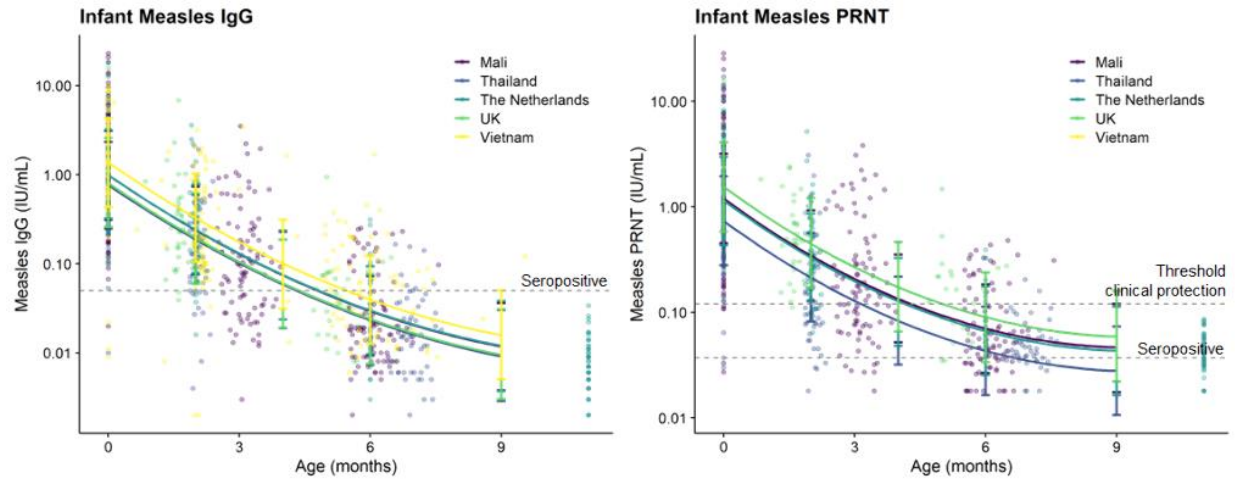

Conclusions/Learning Points: Infants older than 6 months are susceptible to measles infection. These results can inform vaccination programmes.

EFFECTIVENESS OF INFLUENZA VACCINATION DURING PREGNANCY ON LABORATORY-CONFIRMED SEASONAL INFLUENZA AMONG INFANTS UNDER 6 MONTHS OF AGE IN ONTARIO

Oral Presentations Session

ORAL PRESENTATION SESSION 04: VACCINES

Deshayne Fell¹, Margaret Russell², Jeffrey Kwong³, Stephen Fung⁴, Sarah Swayze⁵, Hannah Chung⁵, Sarah Buchan⁶, Weston Roda⁷, Christa Smolarchuk⁸, Kumanan Wilson⁹, Natasha Crowcroft¹⁰, Kevin Schwartz⁶, Jonathan Gubbay¹¹, Allison McGeer¹², Marek Smieja¹³, David Richardson¹⁴, Kevin Katz¹⁵, George Zahariadis¹⁶, Aaron Campigotto¹⁷, Samira Mubareka¹⁸, Dayre McNally¹⁹, Tim Karnauchow¹⁹, Nathan Zelyas²⁰, Lawrence Svenson⁸

¹UNIVERSITY OF OTTAWA AND CHILDREN'S HOSPITAL OF EASTERN ONTARIO RESEARCH INSTITUTE, School Of Epidemiology And Public Health, Ottawa, Canada, ²University of Calgary, Department Of Community Health Sciences, Cumming School Of Medicine, Calgary, Canada, ³ICES and University of Toronto, Dalla Lana School Of Public Health, Toronto, Canada, ⁴Children's Hospital of Eastern Ontario Research Institute, Ri, Ottawa, Canada, ⁵ICES, Populations And Public Health Research Program, Toronto, Canada, ⁶Public Health Ontario, Health Protection, Toronto, Canada, ⁷University of Alberta, Department Of Mathematical And Statistical Sciences, Edmonton, Canada, ⁸Government of Alberta, Alberta Health, Edmonton, Canada, ⁹Ottawa Hospital Research Institute, Clinical Epidemiology Program, Ottawa, Canada, ¹⁰World Health Organization, Department Of Immunization, Vaccines, And Biologicals, Geneva, Switzerland, ¹¹Public Health Ontario, Public Health Ontario Laboratory, Toronto, Canada, ¹²University of Toronto, Dalla Lana School Of Public Health, Toronto, Canada, ¹³McMaster University, Department Of Pathology And Molecular Medicine, Hamilton, Canada, ¹⁴William Osler Health System, Department Of Pathology And Laboratory Medicine, Brampton, Canada, ¹⁵North York General Hospital, Division Of Infection Prevention And Control, Toronto, Canada, ¹⁶Eastern Health Microbiology Services, Public Health And Microbiology Laboratory Of NI, St. John's, Canada, ¹⁷Hospital for Sick Children, Division Of Microbiology, Department Of Paediatric Laboratory Medicine, Toronto, Canada, ¹⁸Sunnybrook Health Sciences Centre, Division Of Microbiology, Department Of Laboratory Medicine, Toronto, Canada, ¹⁹Children's Hospital of Eastern Ontario, Department Of Pediatrics, Ottawa, Canada, ²⁰Alberta Precision Laboratories, Alberta Public Health Laboratory, Calgary, Canada

Backgrounds: Despite high-quality evidence from randomized clinical trials conducted in low-middle income countries showing efficacy of influenza vaccination during pregnancy against influenza infection among infants <6 months of age, assessments of effectiveness in settings with different influenza seasonality and across multiple seasons are limited.

Methods: We conducted a test-negative study using population-based Ontario laboratory data to identify all influenza virus tests (in any clinical setting) among infants <6 months of age during 9 influenza seasons (2010-11 to 2018-19). These data were linked with health administrative data to ascertain information on maternal-infant dyads, including whether women had been vaccinated against influenza during pregnancy. Vaccine effectiveness (VE) was estimated from the adjusted odds ratio for vaccination, computed using logistic regression with adjustment for maternal age, infant age at test, season of conception, prenatal care adequacy, neighbourhood income, and influenza season. Women who received influenza vaccination less than 14 days prior to obstetric delivery or received the previous season's vaccine were treated as unvaccinated.

Results: Among 23,806 infants <6 months of age who were tested for influenza virus, 1,783 (7.5%) tested positive. Overall, 2,168 (9.1%) of infants were born to women vaccinated against influenza during pregnancy; 1,708 (7.2%) remained when those vaccinated less than 14 days before delivery or with the previous season's influenza vaccine were reclassified as unvaccinated. Across seasons, the adjusted effectiveness of influenza vaccination during pregnancy against laboratory-confirmed infant influenza infection prior to 6 months of age was 64% (95% confidence interval: 51% to 74%).

Conclusions/Learning Points: Since infants <6 months are at high risk for serious influenza-related illness, but not eligible for influenza vaccination, immunization during pregnancy is an effective strategy for protecting young infants during their first influenza season.

SAFETY AND IMMUNOGENICITY OF A TWO-DOSE AD26.ZEBOV, MVA-BN-FILO EBOLA VACCINE REGIMEN IN INFANTS: A RANDOMISED, DOUBLE-BLIND, CONTROLLED TRIAL IN SIERRA LEONE AND GUINEA

Oral Presentations Session

ORAL PRESENTATION SESSION 04: VACCINES

Edward Man-Lik Choi¹, Christine Bétard², Frank Baiden³, Boni Alé⁴, Muhamed Afolabi⁵, Boris Lacarra⁶, Julie Foster⁷, Benjamin Hamzé⁸, Christine Schwimmer⁹, Daniela Manno³, Eric D'Ortenzio⁶, David Ishola¹, Babajide Keshinro¹⁰, Yusupha Njie¹, Wim Van Dijck¹¹, Auguste Gaddah¹¹, Dickson Anumendem¹¹, Brett Lowe¹², Renaud Vatrinet⁶, Bolarinde Lawal¹, Godfrey Otieno⁷, Chelsea Mclean¹³, Bailah Leigh¹⁴, Cynthia Robinson¹⁵, Brian Greenwood³, Rodolphe Thiébaud², Deborah Watson-Jones¹⁶

¹London School of Hygiene & Tropical Medicine, Department Of Clinical Research, London, United Kingdom, ²Institut National de la Santé et de la Recherche Médicale, Population Health - Inserm Research Center U1219, Bordeaux, France, ³London School of Hygiene & Tropical Medicine, Faculty Of Infectious And Tropical Diseases, London, United Kingdom, ⁴Institut National de la Santé et de la Recherche Médicale, Statistics, Paris, France, ⁵London School of Hygiene & Tropical Medicine, Department Of Disease Control, London, United Kingdom, ⁶Institut National de la Santé et de la Recherche Médicale, Reacting, Paris, France, ⁷London School of Hygiene & Tropical Medicine, Faculty Of Infectious & Tropical Diseases, Clinical Research Department, London, United Kingdom, ⁸Institut National de la Santé et de la Recherche Médicale, Pôle Recherche Clinique, Paris, France, ⁹Institut National de la Santé et de la Recherche Médicale, University Bordeaux, Bordeaux, France, ¹⁰Janssen Vaccines and Prevention, Clinical Development And Medical Affairs, Leiden, Netherlands, ¹¹Janssen Research & Development, Clinical Research, Beerse, Belgium, ¹²London School of Hygiene & Tropical Medicine, Infectious Diseases, London, United Kingdom, ¹³Janssen Vaccines and Prevention, Viral Vaccines Biomarkers, Leiden, Netherlands, ¹⁴University of Sierra Leone, College Of Medicine And Allied Health Sciences, Freetown, Sierra Leone, ¹⁵Janssen Vaccines and Prevention, Vaccines, Clinical Research, Leiden, Netherlands, ¹⁶London School of Hygiene & Tropical Medicine, Clinical Research Department, London, United Kingdom

Backgrounds: Young children infected with Ebola have high mortality. A heterologous two-dose vaccine regimen (Ad26.ZEBOV [Ad26], MVA-BN-Filo [MVA]) was investigated in infants.

Methods: Healthy infants (4-11 months) in Sierra Leone and Guinea were randomised in a double-blind study to receive Ad26, MVA or Meningococcal Group A, C, W135, Y conjugate vaccine (MenACWY) 56 days apart. Adverse events (AEs) were assessed following each vaccine dose. Serious AEs (SAEs) were assessed from informed consent signing until six months post-dose 2. Binding antibody concentrations against EBOV GP were measured by FANG ELISA at baseline, 21 days post-dose 2, and one year post-dose 1.

Results: A total of 108 infants underwent randomisation: 75 with Ad26, MVA and 33 with MenACWY. The vaccine regimen was well tolerated. The safety profile consisted of mild-to-moderate AEs, with the most common solicited AEs being irritability, decreased appetite, and pyrexia $\geq 38^{\circ}\text{C}$. Pyrexia was more frequent with Ad26, MVA versus control. The frequency of unsolicited AEs was similar in the Ad26, MVA and control groups. No SAEs were related to either vaccine. Strong humoral immune responses were observed in all infants who received the Ad26, MVA vaccine regimen at 21 days post-dose 2 and persisted up to one year in 96% of participants.

Conclusions/Learning Points: The Ad26, MVA Ebola vaccine regimen was well tolerated, induced strong antibody responses in infants, and is suitable for preventing Ebola in infant populations. Binding antibody responses were comparable to levels previously reported in African children (1-3 years) and higher than the response in older children and adults.

O023 / #1168

ROTAVIRUS GENOTYPES CIRCULATING IN EUROPE IN THE ERA OF WIDESPREAD ROTAVIRUS VACCINATION

Oral Presentations Session

ORAL PRESENTATION SESSION 04: VACCINES

Daniel Hungerford^{1,2}, Virginia Pitzer³, Roberto Vivancos^{2,4}, Helen Clough¹, Danni Daniels⁵, Miren Iturriza-Gomara^{1,6}

¹University of Liverpool, Institute Of Infection, Veterinary And Ecological Sciences, Liverpool, United Kingdom, ²NIHR Health Protection Research Unit in Gastrointestinal Infections, University Of Liverpool, Liverpool, United Kingdom, ³Yale School of Public Health, Department Of Epidemiology Of Microbial Diseases, New Haven, United States of America, ⁴UK Health Security Agency, Field Service, North West, Liverpool, United Kingdom, ⁵World Health Organization European Regional Office, Division Of Country Health Programmes, Vaccine-preventable Diseases And Immunization Unit, Copenhagen, Denmark, ⁶PATH, Centre For Vaccine Innovation And Access, Geneva, Switzerland

Backgrounds: We aim to assess whether a switch to non-G1P[8] strains and greater strain diversity post-rotavirus vaccine introduction is associated with vaccination or due to natural fluctuations in strain types across Europe.

Methods: The study area includes 23 countries submitting data to either EuroRotaNet or the WHO EURO Sentinel Surveillance Network for Rotavirus. Epidemiological and microbiological data was collected on genotyped rotavirus-positive samples between 2006 and 2018. To investigate the effect of vaccination on strain types we will fit Bayesian multinomial logistic regression models, with genotype as the outcome. Generalized linear mixed-effect models will be used to analyse the effect of vaccination on strain diversity and richness.

Results: Descriptive analysis of EuroRotaNet countries In the twelve countries contributing to EuroRotaNet, 62,773 samples were characterised during the study period. Seven genotypes contributed 97% of single rotavirus strain typed specimens: G1P[8]; G4P[8]; G2P[4]; G9P[8]; G3P[8]; G12P[8]; and G9P[4]. Since the introduction of routine vaccination in the UK and Germany in 2013 the prevalence of G1P[8] has fallen (Figure 1). In the UK the prevalence of G2P[4] has increased since vaccine introduction, peaking at 79% in 2016/17. However, in 2017/18 in the UK the strain distribution was more diverse, and G3P[8] accounted for 24% of single typed strains. In countries without widespread rotavirus vaccination, there has been a shift since 2015/16 to non-G1P[8] genotypes.

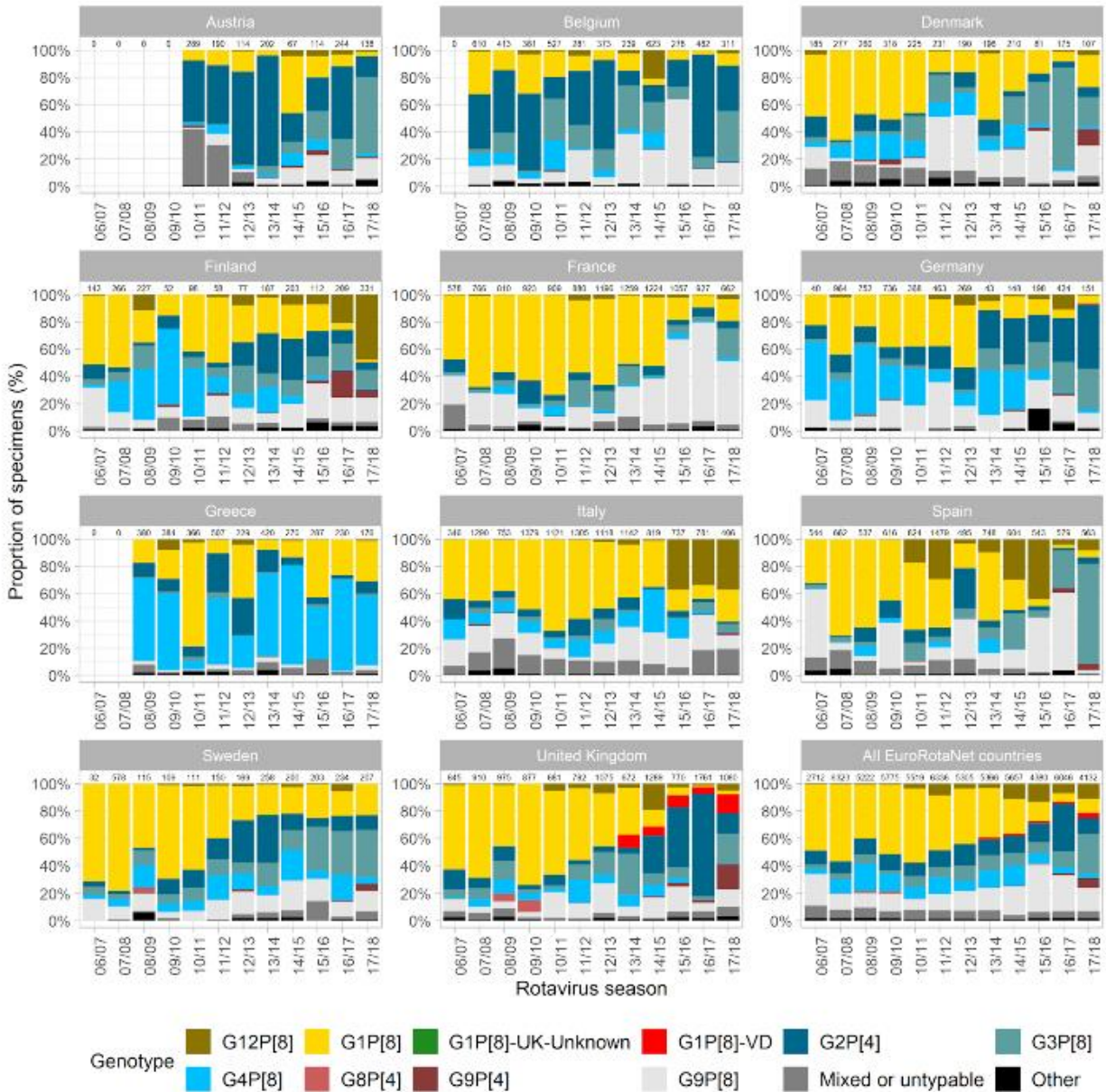

Figure 1. Temporal distribution of rotavirus genotypes, by country in EuroRotaNet, between September 2006 and August 2018. (VD= vaccine derived; total sample numbers are shown at the top of the stacked bar; A year was defined as the 12 months between September and August of the following calendar year).

Conclusions/Learning Points: The consistent decline in G1P[8] strains across both countries with and without infant rotavirus immunization schedules may suggest either that the increase in vaccinated cohorts across Europe is having an impact across borders or that natural fluctuations in strain distributions have coincided with increased rotavirus vaccination across Europe. The statistical analyses are in progress and will allow us to elucidate firmer conclusions.

MODELED IMPACT OF NIRSEVIMAB AGAINST RESPIRATORY SYNCYTIAL VIRUS (RSV) AMONG SPANISH INFANTS EXPERIENCING THEIR FIRST RSV SEASON

Oral Presentations Session

ORAL PRESENTATION SESSION 04: VACCINES

Georgina Drago Manchón¹, Julie Roiz², Paulina Kazmierska², Solene De Boisvilliers³, Javier Álvarez⁴, Ruth Gil-Prieto⁵, Jaime Perez-Martin⁶, Juan Luis López-Belmonte⁷

¹Sanofi Pasteur, Market Access, Barcelona, Spain, ²Evidera, Emc, London, United Kingdom, ³EVIDERA, Emc, Paris, France, ⁴Hospital Costa del Sol, Paediatric Department, Marbella, Spain, ⁵Rey Juan Carlos University, Department Of Medical Specialities And Public Health, Madrid, Spain, ⁶Public Health Council, Public Health Directorate, Murcia, Spain, ⁷Sanofi Pasteur, Market Access, Madrid, Spain

Backgrounds: Respiratory syncytial virus (RSV), a leading cause of viral lower respiratory tract illness (LRTI) in young children, is associated with significant morbidity, especially during their first year of life. Nirsevimab is an investigational long-acting antibody developed to prevent medically attended RSV-LRTI (RSV MALRTI). The objective of this work was to explore public health and economic impact of a strategy that immunizes all Spanish infants experiencing their first RSV season with nirsevimab compared to current standard of practice (SoP).

Methods: A static decision analytic model was developed that tracks the whole Spanish infant cohort, by month of birth, during their first RSV season and considers the different possible RSV-related health outcomes and their associated costs. Impact of nirsevimab was modelled, considering an efficacy of 79.5% in term and preterm infants (based on a pooled analysis from Phase IIb [preterm infants] and MELODY Phase III [term infants] studies), and non-inferiority in palivizumab-eligible infants. An immediate onset of protection, and 5 months of protection were assumed.

Results: The model estimated these cases avoided: 8,201 hospitalisations, including 872 intensive care cases, 24,420 emergency department visits, as well as 93,209 primary care visits and 9 deaths over one season. The associated annual economic savings were estimated at €29.8 million in healthcare costs and €2.3 million in lost productivity, without considering the cost of preventive passive immunization alternatives (Table 1). The largest reduction in events and costs was seen in preterm and term infants. Additionally, reduction in health events provided by nirsevimab impacted infants born out of season in a 2-to-1 ratio compared to infants born in season.

Table 1. Detailed results

| Outcome | Current SoP | Nirsevimab | Difference | Difference (%) |
|---|-------------|-------------|--------------|----------------|
| Number of cases | | | | |
| Inpatient hospitalizations (incl. ICU and MV) | 12,717 | 4,516 | -8,201 | -64% |
| ICU cases (incl. MV) | 1,378 | 506 | -872 | -63% |
| MV | 343 | 122 | -221 | -64% |
| Outpatient hospitalizations | 2,792 | 1,019 | -1,773 | -64% |
| ER visits | 37,860 | 13,440 | -24,420 | -65% |
| Primary care visits | 144,342 | 51,133 | -93,209 | -65% |
| Inpatient deaths | 15 | 6 | -9 | -59% |
| Costs | | | | |
| Total healthcare costs | €46,529,055 | €16,718,774 | -€29,810,280 | -64% |
| Productivity loss costs | €3,906,835 | €1,583,391 | -€2,323,445 | -59% |

ICU = Intensive Care Unit; ER = Emergency Department; MV = Mechanical Ventilation; SOP = Standard of Practice

Conclusions/Learning Points: Immunization of all infants experiencing their first RSV season with nirsevimab is likely to result in thousands of RSV cases avoided versus current SoP.

This study was funded by Sanofi Pasteur, Spain

O025 / #1157

EVALUATION OF PROTECTIVE EFFICACY AND IMMUNOGENICITY OF EPITOPE-BASED PNEUMOCOCCAL VACCINE CANDIDATES USING SYNTHETIC VIRUS-LIKE PARTICLES (SVLPs) IN AN INTRAPERITONEAL SEPSIS MURINE MODEL

Oral Presentations Session

ORAL PRESENTATION SESSION 04: VACCINES

Paraskevi Basdeki¹, John Routsias², Olga Koutsoni³, Eleni Dotsika³, Marien De Jonge⁴, Vassiliki Spoulou¹

¹National and Kapodistrian University of Athens, Medical School, Immunobiology And Vaccinology Research Laboratory, First Department Of Paediatrics, "Aghia Sophia" Children's Hospital, Athens, Greece, ²National and Kapodistrian University of Athens, Medical School, Department Of Microbiology, Athens, Greece, ³Hellenic Pasteur Institute, Laboratory Of Cellular Immunology, Department Of Microbiology, Athens, Greece, ⁴Radboud Institute for Molecular Life Sciences, Radboud University Medical Center, Laboratory Of Pediatric Infectious Diseases, Department Of Pediatrics, Nijmegen, Netherlands

Backgrounds: We have previously identified 4 immunoreactive, linear B-cell epitopes within pneumococcal surface proteins (CbpD, PhtD, PhtE & ZmpB) that are highly conserved among different serotypes. These epitopes, emulsified in Freund's Adjuvant, showed high immunogenicity and offered prolonged survival against murine pneumococcal sepsis. Herein, they were incorporated in SVLPs to improve survival rates and induce robust humoral immune responses without the need for external adjuvants.

Methods: Female BALB/c mice were subcutaneously immunized thrice at three-week intervals with synthetic 20mer peptides displayed on the surface of SVLPs. Positive controls received PCV13, while negative controls received the SVLP-carrier alone. Pneumococcal lethal sepsis was induced by 10⁶ CFUs of an intraperitoneally administered serotype 3 clinical strain and survival was monitored. Sera were collected one day prior the second and third immunization and before the pneumococcal challenge. Antibody responses were assessed using ELISA.

Results: Mice actively immunized with SVLP-conjugated synthetic peptides demonstrated enhanced survival against pneumococcal sepsis, compared to controls (p=0.005-0.04, Wilcoxon test). Five days after infection the survival rate was 100% for the positive control (PCV13), 66.7% for PhtE, 33.3% for CbpD, 16.7% for ZmpB and 0% for PhtD and the negative control (SVLPs), respectively. All immunized mice produced high levels of peptide-specific IgG antibodies. The difference in the endpoint titers, compared to controls, was statistically significant (p=0.0001-0.03, unpaired t-test). All immunized mice elicited gradually higher antibody titers upon receiving the booster immunizations.

Conclusions/Learning Points: SVLP-conjugated synthetic epitopes are able to confer prolonged survival, compared to controls, associated with robust humoral immune responses. Further experiments are needed to assess the protective efficacy of the epitopes with the most promising characteristics in order for them to be considered as candidate antigens for novel pneumococcal vaccine formulations.

O026 / #1496

TISSUE RESIDENT MEMORY T CELLS AND THEIR ROLE IN SUSTAINED IMMUNITY TO BORDETELLA PERTUSSIS FOLLOWING ACELLULAR AND WHOLE CELL VACCINATION IN HUMANS

Oral Presentations Session

ORAL PRESENTATION SESSION 04: VACCINES

Karen Mccarthy, Rachel Mcloughlin, Kingston Mills
Trinity Biomedical Sciences Institute, Biochemistry And Immunology, Dublin, Ireland

Backgrounds: The objective of this study is to investigate if Tissue resident memory T cells (TRM) cells specific for Bordetella pertussis (B.pertussis) are identifiable in human adeno-tonsillar tissue and to determine the impact of acellular or whole cell pertussis vaccination in childhood on the frequency of antigen-specific TRM cells.

Methods: Twenty study participants undergoing elective tonsillectomy were recruited, 10 of whom received the acellular pertussis (aP) vaccine in childhood (<25 years of age) and 10 of whom received the whole cell pertussis (wP) vaccine. Operative tonsil tissue, venous blood and nasopharyngeal swab (B. pertussis culture and PCR) will be collected from each participant. Tonsil and blood mononuclear cells were isolated and cultured with a panel of B. pertussis antigens and antigen-specific cytokine producing TRM were identified via flow cytometry.

Results: We have identified IFN- γ and/or IL-17-producing CD69⁺CD103⁻ and CD69⁺CD013⁺ CD4⁺ T_{RM} cells in human adeno-tonsillar tissue, but not in peripheral blood, which were expanded by culture with sonicated B. pertussis (SBP) and filamentous haemagglutinin (FHA). Adults who received whole cell pertussis vaccination during routine childhood immunisation had significantly more IFN- γ producing CD69⁺ TRM following stimulation with SBP and FHA than aP vaccinated individuals ($p < 0.05$).

Conclusions/Learning Points: Our study demonstrates that in humans, whole cell pertussis vaccination during routine childhood immunisation but not acellular pertussis vaccine induces a population of antigen specific-cytokine producing TRM cells in tonsillar tissue that persist up to 30 years following initial vaccination. In the murine model, these cells in the nose and lung have been associated with protection against colonisation following B. pertussis aerosol challenge. Immunisation strategies that aim to generate a population of protective TRM cells at mucosal site of infection are therefore more likely to induce more effective and sustained protective immunity.

ANTIBODY RESPONSES AND PERSISTENCE AFTER IMMUNISATION WITH A REDUCED RECOMBINANT PERTUSSIS BOOSTER DOSE AMONG ADOLESCENTS

Oral Presentations Session

ORAL PRESENTATION SESSION 04: VACCINES

Thanyawee Puthanakit¹, Auchara Tangsathapornpong², Wassana Wijagkanalan³, Suvaporn Anugulruengkitt¹, Pornumpa Bunjoungmanee², Librada Fortuna³, Vilasinee Yuwaree³, Chawanee Kerdsomboon³, Souad Mansouri³, Terapong Tantawichien⁴

¹Chulalongkorn University, Department Of Pediatrics, Faculty Of Medicine, Bangkok, Thailand, ²Thammasat University, Department Of Pediatrics, Faculty Of Medicine,, Bangkok, Timor-Leste, ³BioNet, Bangkok, Thailand, Bionet, Bangkok, Thailand, Bangkok, Thailand, ⁴Chulalongkorn University, Department Of Medicine, Faculty Of Medicine And Chula Tropical Medicine Cluster, Bangkok, Thailand

Backgrounds: The pertussis resurgence calls for new vaccines. Recombinant acellular pertussis (aP_{gen}) vaccines containing 5µg of genetically detoxified Pertussis Toxin (Pe_{on}) and 5 µg Filamentous Hemagglutinin (FHA) are licensed in Singapore and Thailand. The safety and immunogenicity of recombinant reduced dose ap-2,5 (2µg PT_{gen}, 5µg FHA) or combined to tetanus and diphtheria (Tdap-2,5) are compared to a chemically detoxified PT (Tdap_{chem}) vaccine.

Methods:: A phase 2/3, randomized controlled, observer-blind trial aimed at demonstrating the non-inferior immunogenicity in 450 adolescents aged 9-17 years at two sites in Thailand. The participants were enrolled in 1:1:1 to receive ap-2,5, Tdap-2,5 or Tdap_{chem} vaccine. Seroconversion rate, defined as the 4-fold increase of anti-PT and anti-FHA IgG, was compared at Day 28 after vaccination and in a subset of participants at Day 336. At Day 28 after vaccination, non-inferiority was reached if the lower limit of the 95% CI of difference in seroconversion rate was higher than the non-inferiority margins (-10%). The superiority can also be concluded if the difference in seroconversion rates lied above zero.

Results: From June to August 2019, 450 adolescents with median age of 12 years were enrolled. Seroconversion rates were statistically significant higher in ap-2,5 and Tdap-2,5 than in Tdap_{chem} group for ELISA anti-PT, after 1 month: 93% (95% CI 88-97), 94% (90-98) and 70% (63-78) respectively (P ≤ 0.05); and after 1 year: 73% (61-86), 56% (42-70) and 16% (6-26) (P ≤ 0.05). Similar findings were found for anti-FHA. Both non-inferiority and superiority of ap_{gen} and Tdap_{gen} vaccines vs Tdap_{chem} vaccine were met. No vaccine-related serious adverse event was reported.

Conclusions/Learning Points: Both recombinant reduced dose ap_{gen} and Tdap_{gen} vaccines were safe and able to induce high and persisting pertussis antibody response.

EFFECTIVENESS OF PERTUSSIS VACCINES AMONG MEXICAN CHILDREN BETWEEN 2000 AND 2019

Oral Presentations Session

ORAL PRESENTATION SESSION 04: VACCINES

Geraldo Luna Casas¹, Gilberto Sanchez¹, Juan Camilo Vargas-Zambrano², Denis Macina²

¹Estimatio Health Economic and Outcomes Research Services, Medical, Mexico, Mexico, ²Sanofi, Global Medical - Vaccines, Lyon, France

Backgrounds: Mexico's early childhood pertussis immunization schedule consists of 4 doses, given at 2, 4, 6, and 18 months of age. A European-manufactured whole-cell pertussis (wP) vaccine was used in 2000-2007. Since 2008, 2-component acellular pertussis vaccines (2aP) have been used. This study estimated the effectiveness of 3 or 4 doses of the two vaccine types used in Mexico between 2000 and 2019.

Methods:: Pertussis cases among 6.5-48.5-month-olds reported over 2000-2019, their vaccination status and diagnosis confirmation type (clinical, laboratory or Epilink) were obtained from the Mexican National pertussis surveillance system. Vaccine coverage rates were derived from Mexico's CeNSIA and CONAPO databases. Vaccine effectiveness (VE) was estimated using the screening method.

Results: Comparable VE estimates were observed in the wP (2000-2007) and 2aP (2008-2019) vaccines periods, ranging from 94 to 97%, after either 3 or 4 doses, and regardless of the case-definition used (all notifications vs laboratory-confirmed only).

| | Time Period (Vaccine-type) | Unvaccinated Cases (lab confirmed) | Fully Vaccinated Cases (lab confirmed) | Proportion of vaccinated cases (lab VCR DTP3 confirmed) | |
|---|-------------------------------|---------------------------------------|---|---|--------|
| 6.5-18.5 months Cases (3vs0 doses) | 2000-2007(wP) | 54(11) | 57(9) | 0.51(0.45) | 85.18% |
| | 2008-2019(2aP) | 606(384) | 496(206) | 0.45(0.35) | 82.43% |
| 18.5-48.5 months Cases (4vs0 doses) | 2000-2007(wP) | 17(3) | 11(3) | 0.61(0.50) | - |
| | 2008-2019(2aP) | 129(81) | 133(67) | 0.49(.45) | - |

Conclusions/Learning Points: Over the 11-year period of their use, the pentavalent and hexavalent 2aP vaccines used in Mexico demonstrated as strong protective effectiveness as the previously used wP vaccine, ensuring protection from pertussis among vaccinated children at least up to the age of a scheduled school-entry booster. Maintaining high vaccination coverage rates is essential in preventing and controlling pertussis.

COMPARISON OF CLINICAL FEATURES OF MULTISYSTEM INFLAMMATORY SYNDROME IN CHILDREN, KAWASAKI DISEASE AND TOXIC SHOCK SYNDROME

Oral Presentations Session

ORAL PRESENTATION SESSION 05: COVID-19 SESSION II

Lizete Klavina^{1,2}, Lauma Vasilevska^{1,2}, Anda Kivite-Urtane³, Ieva Roge⁴, Anija Meiere⁴, Iveta Racko², Liene Smāne⁴, Zanda Pucuka⁵, Zane Davidsons⁶, Jana Pavare²

¹Rīga Stradiņš University, Department Of Paediatrics, Rīga, Latvia, ²Children's Clinical University Hospital, Department Of Paediatrics, Rīga, Latvia, ³Rīga Stradiņš University, Department Of Public Health And Epidemiology, Rīga, Latvia, ⁴Children's Clinical University Hospital, Department Of Infectology, Rīga, Latvia, ⁵Children's Clinical University Hospital, Department Of Emergency Medicine, Rīga, Latvia, ⁶Children's Clinical University Hospital, Department Of Rheumatology, Rīga, Latvia

Backgrounds: The COVID-19 pandemic has brought numerous challenges. One of them is multisystem inflammatory syndrome in children (MIS-C), developing two to six weeks after acute SARS-CoV-2 infection. This study aimed to describe the clinical characteristics of patients who met the criteria for MIS-C, and compare them with the features of Kawasaki disease (KD) and toxic shock syndrome (TSS).

Methods: This retrospective study was conducted at the Children's Clinical University Hospital in Rīga, Latvia, and involved children <18 years old who were hospitalized during the period from 2012 to 2021 with MIS-C, KD or TSS. Clinical data was collected from medical records and analysed using descriptive parametric and non-parametric statistics. A statistically significant difference between groups was assumed where p value <0.05.

Results: In all, 81 children were included in the study: 39 (48.1%) with KD (mean age 3.9 (SD 3.7) years; 23 boys (59%)), 29 (35.8%) with MIS-C (mean age 9.8 (SD 4.5) years; 16 boys (55.2%)) and 13 (16.1%) with TSS (mean age 11.3 (SD 5.2) years; 5 boys (38.5%)). The time from symptom onset to diagnosis was shorter in TSS compared with MIS-C and KD (p<0.001). Patients with MIS-C differ from those with KD, with more frequent gastrointestinal symptoms (e.g., abdominal pain, vomiting, diarrhoea), neurological manifestations (e.g., headache, meningism/photophobia, hyperaesthesia) and cardiac involvement at onset (i.e., valvular insufficiency, pericardial effusions, systolic dysfunction)(p<0.01). Meanwhile, cervical lymphadenopathy, synovitis and arthralgia were significantly more common in KD compared with MIS-C and TSS (p<0.05).

Conclusions/Learning Points: Children with MIS-C display specific clinical features when compared with those with KD and TSS. The overlapping signs and symptoms of these childhood diseases make an appropriate diagnosis challenging.

O030 / #669

FEATURES OF COVID-19 IN CHILDREN DURING THE OMICRON WAVE IN MADRID, COMPARED TO PREVIOUS WAVES

Oral Presentations Session

ORAL PRESENTATION SESSION 05: COVID-19 SESSION II

Teresa Reinoso Lozano¹, Ane Plazaola Cortazar¹, Olga-Nerea Coya², Beatriz Iglesias González¹, Adriana Navas³, David Aguilera⁴, Alfonso Cañete¹, Raquel Guillén², Cinta Moraleda⁵, Ángela Somodevilla², David Melero², Ana Pérez-Villena¹, Alfredo Tagarro¹

¹Hospital Universitario Infanta Sofía, Paediatrics, San Sebastián de los Reyes, Spain, ²Hospital Universitario Infanta Sofía, Microbiologics, San Sebastián de los Reyes, Spain, ³Hospital Infanta Leonor, Paediatrics, Madrid, Spain, ⁴Hospital General Universitario Gregorio Marañón, Paediatrics, Madrid, Spain, ⁵HOSPITAL 12 DE OCTUBRE, Paediatrics, MADRID, Spain

Backgrounds: SARS-CoV-2 variant Omicron (B.1.1.529) is causing the actual wave in Spain, leading to the highest cumulative incidence across the pandemic. It is not known whether this variant causes more severe disease in children.

Methods: Clinical features were collected from children attended at the Emergency Room (ER) at a secondary center in Madrid from December 20th 2021 to January 2nd 2022. Charts were reviewed 1 week after diagnosis to check potential complications. Data were compared to children with other variants included in the national COVID-19 database EPICO-AEP. In this comparison, 17 ambulatory patients with Omicron from other center were also included to make data more robust.

Results: 94/1360 children (9.6%) had COVID-19. In 16% of them, variant was identified: 87% Omicron, 13% Delta. Median age was 6.5 years, only 7% were >12 years. Final diagnosis were upper respiratory tract infection (URTI) 61/94 (65%), flu-like syndrome 15/94 (16%), gastroenteritis 7/94 (7%), fever without source (FWS) 3/94 (3%), and migraine or asthma flare 2/94 each (2%). Only 2/94 (2%) patients were hospitalized: a 3-year girl with features of bacterial pneumonia and an Omicron variant; and a 40-days-old infant with whooping-like cough with negative RT-PCR for both Bordetella pertussis and RSV. Hospitalization rate was similar in Omicron and Alpha variant waves (2% vs 4%, p=0.656). Compared to other waves, URTI, headache and fever were more frequent in the Omicron wave, while pneumonia and FWS were in previous waves.

Table 1. Comparison between features of ambulatory children attended during Omicron wave and during other waves attended at the Emergency Room. The syndromic diagnosis was not recorded in 19 cases diagnosed in other waves; percentages and p-values are calculated omitting those cases. Significant p-values (<0.05) are in bold.

| Features | Other waves N=546 n (%) | Omicron wave N=109 n (%) | p-value |
|--|-------------------------------|--------------------------------|------------------|
| Sex (female) | 289 (52.9%) | 60 (55.0%) | 0.686 |
| Age (years), median (IQR) | 5.7 (1.1, 11.7) | 6.6 (1.3, 9.8) | 0.330 |
| Age band | | | <0.001 |
| 0 to 4 years | 259 (47.4%) | 47 (43.1%) | |
| 5 to 12 years | 162 (29.7%) | 54 (49.5%) | |
| 12 years or above | 125 (22.9%) | 8 (7.3%) | |
| Comorbidity | 99 (18.1%) | 12 (11.0%) | 0.070 |
| Contact with household confirmed case | 240 (44.0%) | 33 (30.3%) | 0.008 |
| Symptoms/signs | | | |
| Fever | 371 (67.9%) | 90 (82.6%) | 0.002 |
| Cough | 264 (48.4%) | 61 (56.0%) | 0.147 |
| Sore throat | 99 (18.1%) | 20 (18.3%) | 0.957 |
| Runny nose | 197 (36.1%) | 49 (45.0%) | 0.081 |
| Fatigue, malaise | 73 (12.2%) | 12 (11.0%) | 0.728 |
| Wheezing | 23 (4.2%) | 2 (1.8%) | 0.237 |
| Headache | 88 (16.1%) | 35 (32.1%) | <0.001 |
| Myalgia | 48 (8.8%) | 4 (3.7%) | 0.071 |
| Diarrhea | 75 (13.7%) | 23 (21.1%) | 0.049 |
| Vomiting | 91 (16.7%) | 23 (21.1%) | 0.265 |
| Syndromic diagnosis* | | | |
| Upper Respiratory Tract Infection | 195 (37.0%) | 73 (67.0%) | <0.001 |
| Flu-like | 80 (15.2%) | 14 (12.8%) | 0.532 |
| Fever without a source | 84 (15.9%) | 5 (4.6%) | 0.002 |
| Gastroenteritis | 40 (7.6%) | 7 (6.4%) | 0.671 |
| Pneumonia | 38 (7.2%) | 1 (0.9%) | 0.013 |
| Asymptomatic | 44 (8.3%) | 3 (2.8%) | 0.042 |
| Bronchitis/Asthma flare | 18 (3.4%) | 2 (1.8%) | 0.389 |
| Bronchiolitis | 2 (0.4%) | 0 (0.0%) | 0.519 |

Conclusions/Learning Points: Children with COVID-19 and Omicron variant seem to have similar profile as other variants, only more fever and URTI and less pneumonia.. Most children were <12 years, which may be related to the high proportion of vaccinated adolescents in our population.

LONG COVID IN CHILDREN AND ADOLESCENTS - A RETROSPECTIVE STUDY IN A PEDIATRIC COHORT

Oral Presentations Session

ORAL PRESENTATION SESSION 05: COVID-19 SESSION II

Joana Lima, Luis Salazar, Alexandre Fernandes, Carla Teixeira, Laura Marques, Alberto Caldas Afonso
 Centro Materno Infantil do Norte, Centro Hospitalar Universitário do Porto (CHUPorto), Pediatric
 Department, Infectious Diseases And Immunodeficiencies Unit, Porto, Portugal

Backgrounds: Studies on clinical outcomes of children with COVID-19 are scarce, particularly in those with asymptomatic and mild disease. We aimed to describe COVID-19 persistent symptoms in patients presenting to a tertiary hospital and to search risk factors for the development of long COVID.

Methods: A retrospective study was performed including all the patients under 18 years that presented at our tertiary hospital between March 2020 and September 2021 that had a positive SARS-CoV-2 PCR test. At admission they were monitored on a home-care basis by telephone and then, with an appointment at 4,12 and 24 weeks to evaluate persistent symptoms.

Results: A total of 242 patients were included, 55.0% of them females, mean age of 77 months, with 38.0% of adolescents. Chronic conditions were identified in 36.0% and 7.4% were obese. At admission, 5.8% had moderate disease and 2.9% severe. At 4 weeks, 20.1% had persistent symptoms (Graph 1): fatigue (8.7%), chronic cough (6.7%) and rhinorrhea (6.6%). At 12 weeks, 13.1% had symptoms: fatigue (7.4%), behavioral changes (4.4%) and sleep disturbance (3.7%). At 24 weeks, 6.5% had symptoms: sleep disturbance (3.6%) and fatigue (2.9%). Symptoms' persistence was more frequent in patients with chronic conditions (12x more at 24 weeks, $p<0.05$). Persistent fatigue was more prevalent in adolescents ($p=0.013$), obese ($p<0.01$) and with severe disease ($p<0.01$). Behavioral changes were also more frequent in adolescents ($p=0.021$).

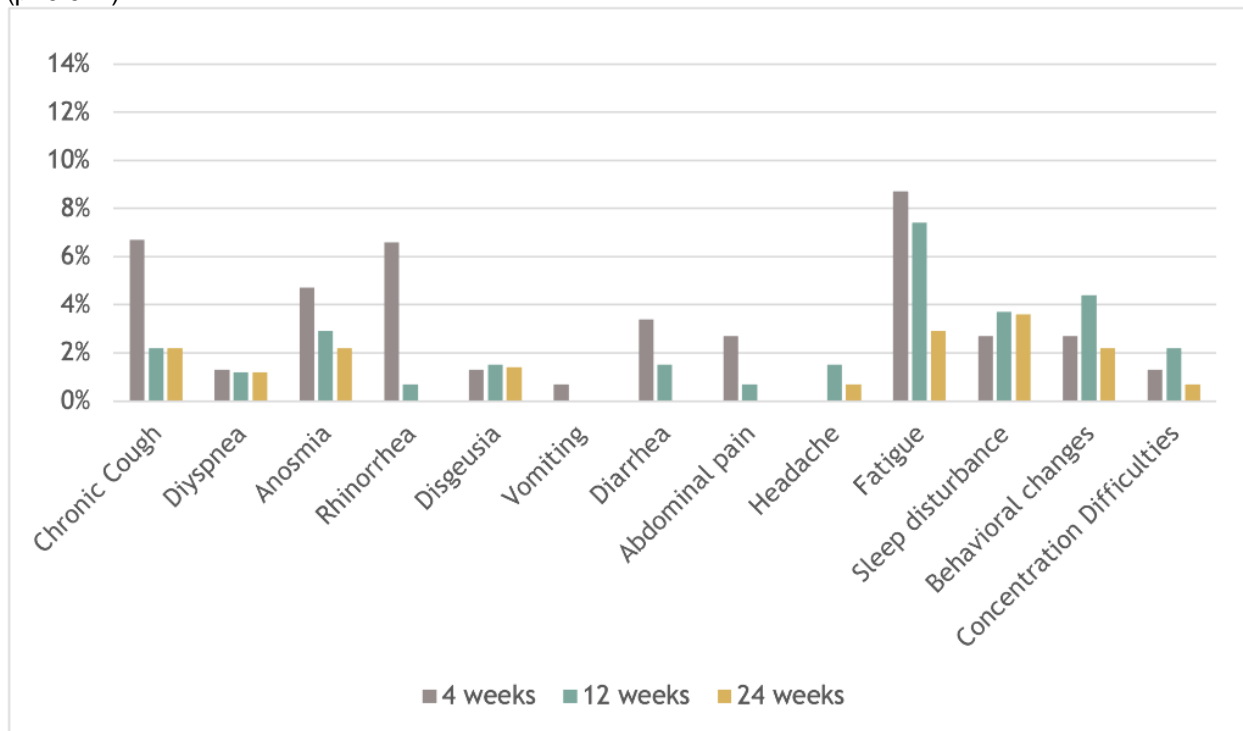

Conclusions/Learning Points: In our cohort, an important proportion of patients presented symptoms after COVID infection, being respiratory symptoms more frequent in the first weeks and neuropsychiatric

symptoms over time. Chronic conditions and obesity were risk factors for persistent symptoms at 6 months after illness and adolescents were the group with greater risk for long-COVID. Persistent fatigue was of utmost importance.

SYSTEMIC AND MUCOSAL HUMORAL IMMUNITY AGAINST SARS-COV-2 IN CHILDREN

Oral Presentations Session

ORAL PRESENTATION SESSION 05: COVID-19 SESSION II

Maya Keuning¹, Marloes Grobben², Merijn Bijlsma³, Beau Anker³, Eveline Berman - De Jong³, Sophie Cohen³, Mariet Felderhof⁴, Femke De Groof⁵, Maarten Rijpert⁶, Hetty Van Eijk², Khadija Tejjani², Maurice Steenhuis⁷, Theo Rispens⁷, Frans Plötz^{3,8}, Marit Van Gils², Dasja Pajkrt^{9,10}

¹Amsterdam UMC, University of Amsterdam, Department Of Pediatric Infectious Diseases, Rheumatology & Immunology, Amsterdam, Netherlands, ²Amsterdam Infection and Immunity Institute, Department Of Medical Microbiology And Infection Prevention, Amsterdam, Netherlands, ³Emma Children's Hospital, Amsterdam University Medical Centre, Paediatrics, Amsterdam, Netherlands, ⁴Flevoziekenhuis, Department Of Pediatrics, Almere, Netherlands, ⁵Noordwest Ziekenhuisgroep, Department Of Pediatrics, Alkmaar, Netherlands, ⁶Zaans Medisch Centrum, Department Of Pediatrics, Zaandam, Netherlands, ⁷Sanquin Research, Department Of Immunopathology, Amsterdam, Netherlands, ⁸Tergooi Hospital, Paediatrics, Blaricum, Netherlands, ⁹Amsterdam University Medical Centre, Pediatric Infectious Diseases, Amsterdam, Netherlands, ¹⁰Emma Children's Hospital, Pediatric Infectious Diseases, H8-253, Amsterdam, Netherlands

Backgrounds: Patients produce systemic and mucosal antibodies after SARS-CoV-2 infection. In the context of ongoing public health measures and vaccination programs, it is crucial to explore practical methods to monitor this humoral immunity. Following our earlier findings of heterogeneity in serum and saliva SARS-CoV-2 antibodies in 2020, we now describe antibody prevalence in serum and saliva of children one year after the beginning of the pandemic and explore associations.

Methods: We assessed SARS-CoV-2 antibody prevalence in serum and saliva of 223 children attending medical services in the Netherlands (irrespective of COVID-19 exposure) from May - October 2021. The cohort included vaccinated and unvaccinated children (< 18 years old) and was compared to 517 unvaccinated children from the April - October 2020 cohort. We measured SARS-CoV-2 spike- and nucleocapsid-specific IgG prevalence in serum and saliva.

Results: Our cohort contained 75% unvaccinated children, 18% with a PCR-proven history of COVID-19, and a 1:1 male-female ratio. Antibody prevalence increased from 3-4% in both serum and saliva in 2020 to 38% (95% CI 31 - 45) in serum and 31% (95% CI 25 - 38) in saliva in 2021. Paired analysis (figure 1) showed positive titers in both serum and saliva in 53/196 (27%). Prevalence of spike and nucleocapsid-specific IgG was significantly lower in saliva compared to serum ($P < 0.05$). Girls showed a higher prevalence of saliva antibodies as compared to boys (OR 2.26 corrected for age, vaccination status, comorbidity, positive PCR).

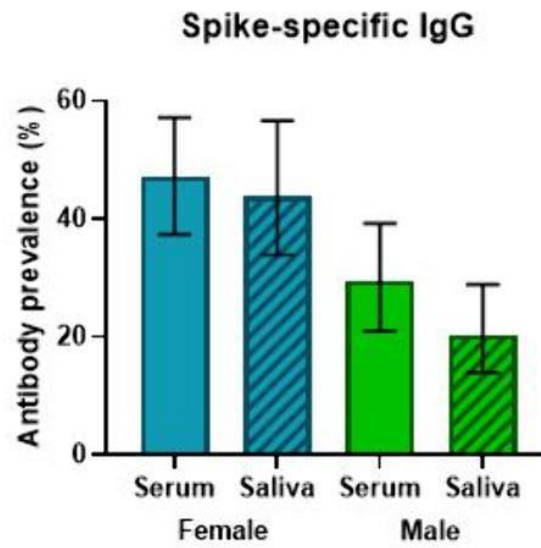
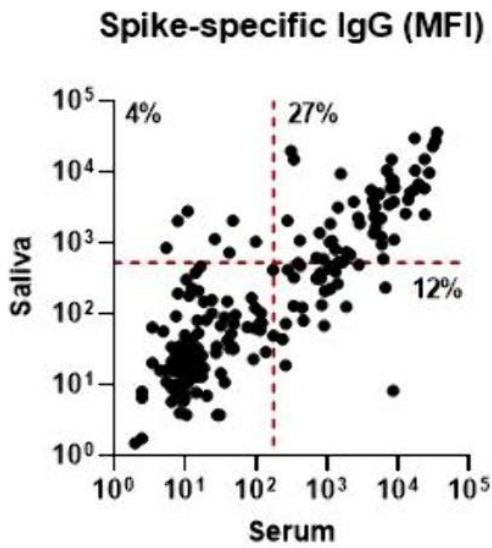

Conclusions/Learning Points: SARS-CoV-2 antibody prevalence in children increased in serum and saliva between 2020 and 2021 in the Netherlands. We observed lower SARS-CoV-2 antibody prevalence in saliva compared to serum, which should be taken into account when evaluating humoral immunity.

O033 / #882

DECREASED PASSIVE IMMUNITY TO RESPIRATORY VIRUSES THROUGH HUMAN MILK DURING THE COVID-19 PANDEMIC.

Oral Presentations Session

ORAL PRESENTATION SESSION 05: COVID-19 SESSION II

Hannah Juncker¹, Marloes Grobben², Karlijn Van Der Straten², Ayesha Lavell³, Michiel Schinkel⁴, David Buis³, Maarten Wilbrink¹, Khadija Tejjani², Mathieu Claireaux⁴, Aafke Aartse⁵, Christianne De Groot⁶, Dasja Pajkt¹, Marije Bomers³, Jonne Sikkens³, Marit Van Gils², Johannes Van Goudoever¹, Britt Van Keulen¹

¹Amsterdam University Medical Center, Pediatrics, Amsterdam, Netherlands, ²Amsterdam Infection and Immunity Institute, Department Of Medical Microbiology And Infection Prevention, Amsterdam, Netherlands, ³Amsterdam Institute for Infection and Immunity, Department Of Internal Medicine, Amsterdam, Netherlands, ⁴Amsterdam Institute for Infection and Immunity, Center For Experimental And Molecular Medicine, Amsterdam, Netherlands, ⁵Biomedical Primate Research Centre, Department Of Virology, Rijswijk, Netherlands, ⁶Amsterdam Reproduction & Development Research Institute, Department Of Obstetrics And Gynaecology, Amsterdam, Netherlands

Backgrounds: Infants may develop severe viral respiratory tract infections because their immune system is still undeveloped. Human milk provides passive humoral immunity during the first months of life. During the COVID-19 pandemic, circulation of common respiratory viruses was virtually absent due to the preventative measures resulting in reduced maternal exposure. Therefore, we hypothesized that this might result in lower antibody levels in human milk during the pandemic and, subsequently, decreased protection of infants against viral respiratory tract infections.

Methods: We assessed antibody levels against respiratory syncytial virus (RSV), Influenza virus, and several seasonal coronaviruses in different periods of the COVID-19 pandemic in serum and human milk using a Luminex assay.

Results: IgG levels against RSV, Influenza, HCoV-OC43, HCoV-HKU1, and HCoVNL63 in human milk were reduced with a factor of 1.7 ($p < 0.001$), 2.2 ($p < 0.01$), 2.6 ($p < 0.05$), 1.4 ($p < 0.01$), and 2.1 ($p < 0.001$), respectively, since the introduction of the COVID-19 restrictions. Furthermore, we observed that human milk of mothers that experienced COVID-19 contained increased levels of IgG and IgA binding to other respiratory viruses.

Conclusions/Learning Points: Passive immunity via human milk against common respiratory viruses was reduced during the COVID-19 pandemic, which may put breastfed infants at increased risk for respiratory infections.

COMPARING THE HUMAN MILK ANTIBODY RESPONSE AFTER FOUR DIFFERENT VACCINES AGAINST COVID-19: HIGHEST SARS-COV-2-SPECIFIC ANTIBODIES AFTER VACCINATION WITH MRNA-BASED VACCINES

Oral Presentations Session

ORAL PRESENTATION SESSION 05: COVID-19 SESSION II

Hannah Juncker¹, Sien Mulleners¹, Esmée Coenen¹, Eliza Ruhé¹, Sjors Bakker¹, Maritt Van Doesburg¹, Jolinda Harinck¹, Romee Rood¹, Joey Bouhuijs², Melissa Oomen², Christianne De Groot³, Dasja Pajkrt¹, Aniko Korosi⁴, Johannes Van Goudoever⁵, Marit Van Gils², Britt Van Keulen⁶
¹Amsterdam University Medical Center, Pediatrics, Amsterdam, Netherlands, ²Amsterdam Infection and Immunity Institute, Department Of Medical Microbiology And Infection Prevention, Amsterdam, Netherlands, ³Amsterdam Reproduction & Development Research, Department Of Obstetrics And Gynaecology, Amsterdam, Netherlands, ⁴Swammerdam Institute for Life Sciences, Center For Neuroscience, Amsterdam, Netherlands, ⁵Amsterdam UMC, University of Amsterdam, Vrije Universiteit, Emma Children's Hospital, Pediatrics, Amsterdam, Netherlands, ⁶Amsterdam UMC, University of Amsterdam, Vrije Universiteit, Emma Children's Hospital, Pediatric Infectious Diseases, Amsterdam, Netherlands

Backgrounds: Vaccination of lactating women against COVID-19 may protect not only themselves but also their breast-fed infant through human milk. Therefore, it is important to gain insight into the human milk antibody response after immunization with the various vaccines that are currently widely used. The aim of this study is to determine and compare the antibody response in human milk following vaccination with mRNA- and vector-based vaccines up to over 2 months post-vaccination.

Methods: In this prospective cohort study, human milk samples from women receiving four different SARS-CoV-2 vaccines were collected longitudinally during a period of 70 days. SARS-CoV-2-specific antibodies were measured using an enzyme-linked immunosorbent assay. The area under the curve of the antibody response was determined over 15 and 70 days following vaccination and compared between the different vaccines.

Results: This study enrolled 134 vaccinated lactating women, who provided a total of 1887 human milk samples. After vaccination with an mRNA-based vaccine, almost all participants (96/97%) showed detectable SARS-CoV-2-specific antibodies in their milk, whereas only 37-50% of the participants who received a vector-based vaccine showed human milk antibodies. The mean area under the curve of SARS-CoV-2-specific antibodies in human milk over 70 days was the highest after vaccination with an mRNA-based vaccine.

Conclusions/Learning Points: Maternal vaccination during lactation with an mRNA-based vaccine resulted in higher SARS-CoV-2 IgA and IgG responses in human milk compared to vector-based vaccines. Therefore, vaccination with mRNA-based vaccines might not only provide better immunological protection for the mother but also for her breast-fed infant.

O035 / #1151

IMMUNOGENICITY OF THE BNT162B2 COVID-19 VACCINE IN PEDIATRIC AND YOUNG ADULT PATIENTS WITH CYSTIC FIBROSIS

Oral Presentations Session

ORAL PRESENTATION SESSION 05: COVID-19 SESSION II

Athanasios Michos¹, Filippos Filippatos¹, Elizabeth- Barbara Tatsi², Charilaos Dellis¹, Vasiliki Eftymiou², Ioanna Zarkada³, Evgenia Troupi³, Vassiliki Syriopoulou¹, Ioanna Loukou⁴

¹National and Kapodistrian University of Athens, First Department Of Pediatrics, Infectious Diseases And Chemotherapy Research Laboratory, 'Aghia Sophia' Children's Hospital, Athens, Greece, Athens, Greece, ²National and Kapodistrian University of Athens, University Research Institute For Maternal And Child Health And Precision Medicine, Athens, Greece, Athens, Greece, ³Cystic Fibrosis Department, "Aghia Sophia" Children's Hospital, Athens, Greece, Cystic Fibrosis Department, "Aghia Sophia" Children's Hospital, Athens, Greece, Athens, Greece, ⁴"Aghia Sophia" Children's Hospital, Cystic Fibrosis, Athens, Greece

Backgrounds: Cystic fibrosis (CF) patients constitute a high-risk group for severe COVID-19. We prospectively measured total (TAbS-RBD; U/ml) and neutralizing (NAbS-RBD; %) antibodies of SARS-CoV-2 spike-RBD protein before immunization, 20 days after the 1st and 30 days after the 2nd dose of the BNT162b2 vaccine in CF patients and healthy controls.

Methods: Serum samples were tested using the Elecsys® Anti-SARS-CoV-2 S reagent. Values of ≥ 0.8 U/ml are positive. The determination of anti-RBD neutralization titers was carried out using the Food and Drug Administration (FDA) approved blocking ELISA cPass™ SARS-CoV-2 neutralization antibody detection kit. Percentages of $\geq 30\%$ were positive. A statistical analysis was performed for the comparison of the two groups and the possible association of antibody levels with epidemiological and clinical parameters.

Results: A total of 33 patients with CF and 66 healthy controls were included in the study. The median age (IQR) of the CF group was 19.6 (17.6-24.3) years and 18 (54.5%) were females. CF patients had statistically significant higher antibody responses regarding TAbS-RBD and NAbS-RBD after both doses (P -value <0.001). One month after the 2nd dose, CF and controls had TAbS-RBD (IQR): 3396 (2443) and 1452 (1231) U/ml, respectively. Similarly, the NAbS-RBD (%) were: 97.30 (1.00) and 95.70 (3.71) (%), respectively. Among CF patients no statistically significant differences were detected for TAbS-RBD or NAbS-RBD regarding gender, pancreatic status, CFTR genotype of CF, use of CFTR modulators and chronic *Pseudomonas Aeruginosa* infection.

Conclusions/Learning Points: The BNT162b2 vaccine was more immunogenic in patients with CF patients compared to healthy controls regardless of the CFTR genotype, related comorbidities, treatment type or severity of disease. Longitudinal studies regarding the kinetics of antibodies will be important to determine the appropriate timing for a booster dose in this population.

O036 / #1221

MYOCARDITIS AND MYOPERICARDITIS CASES FOLLOWING COVID-19 MRNA VACCINES (COMIRNATY [PFIZER-BIONTECH] AND SPIKEVAX [MODERNA]) ADMINISTERED TO 12–17-YEAR-OLDS IN VICTORIA, AUSTRALIA

Oral Presentations Session

ORAL PRESENTATION SESSION 05: COVID-19 SESSION II

Daryl Cheng^{1,2,3,4}, Hazel Clothier^{1,4,5}, Priya Shenton¹, Emma Roney^{1,4}, Nicholas Cox⁶, Bryn Jones⁷, Nigel Crawford^{1,2,3}, Jim Buttery^{3,4,8,9}

¹Murdoch Children's Research Institute, Saefvic, Infection And Immunity, Parkville, Australia, ²Royal Children's Hospital, Department Of General Medicine, Parkville, Australia, ³University of Melbourne, Department Of Paediatrics, Parkville, Australia, ⁴Murdoch Children's Research Institute, Centre For Health Analytics, Parkville, Australia, ⁵University of Melbourne, School Of Population & Global Health, Parkville, Australia, ⁶Western Health, Department Of Cardiology, Sunshine, Australia, ⁷Royal Children's Hospital, Department Of Cardiology, Parkville, Australia, ⁸Royal Children's Hospital, Infectious Diseases/research, Melbourne, Australia, ⁹Department of Health, Saefvic, Melbourne, Australia

Backgrounds: Australia has utilized two mRNA vaccines as part of its COVID-19 vaccine strategy in 12–17 year-olds, namely Comirnaty BNT162b2 COVID-19 (Pfizer-BioNTech) and Spikevax mRNA-1273 (Moderna). Of particular interest in the young adult population is post-vaccination myocarditis causally associated with COVID-19 mRNA vaccines. Post-licensure observational and report-based case studies confirmed the highest risk group is young males (<24 years old) following the 2nd vaccine dose. Due to this AESI signal, the risk, clinical manifestations and follow-up of myocarditis has been of particular interest. This study describes clinical presentation and evaluation of myocarditis AESI following mRNA COVID-19 vaccination in 12–17-year-old adolescents in Victoria, Australia.

Methods: Identified reports of myocarditis in 12–17-year-old vaccinees submitted to SAEFVIC, the state-wide vaccine safety service, between 22 February and 30 November 2021 were assessed. Diagnostic test results were obtained to confirm the diagnoses. Each case was categorized by two independent experts utilizing the Brighton Collaboration definition with graded levels of certainty.

Results: Rigorous clinical review demonstrated definite (Brighton level 1) or probable (level 2) diagnoses in 53 cases, with one case possible (level 3). As of 30th November 2021, the 54 reports of confirmed myocarditis, equated to a rate of 7.0 per 100,000 doses in this age group. Cases were predominantly male (n=48, 88.9%) and post dose 2 (n=44, 81.5%). Rates peaked in the 16–17-year-old age group and were higher in males than females (12.2 v 1.6 per 100,000, p<0.001). Troponin levels differed between sexes, with males recording substantially higher levels.

Conclusions/Learning Points: Accurate evaluation and confirmation of episodes of COVID-19 mRNA vaccine associated myocarditis enabled understanding of clinical phenotypes in the pediatric and adolescent age group. Any potential vaccination and safety surveillance policies needs to consider age and gender differences.

INDIVIDUALISED VANCOMYCIN DOSING IN YOUNG INFANTS: PROSPECTIVE CLINICAL VALIDATION OF A NOVEL ONLINE DOSING CALCULATOR

Oral Presentations Session

ORAL PRESENTATION SESSION 06: ANTIMICROBIALS & ANTIBIOTIC STEWARDSHIP

Amanda Wilkins^{1,2,3}, Tony Lai⁴, Srinivas Bolisetty^{5,6}, Roberto Chiletto^{7,8}, Noel Cranswick^{1,2,8}, Nigel Curtis^{2,3,9}, Stephen Duffull¹⁰, Kaya Gardiner^{3,11}, Rod Hunt^{12,13,14}, Atul Malhotra^{12,14}, Brendan McMullan^{6,15}, Bhavesh Mehta¹⁶, Joanna Michalowski⁵, Himanshu Popat^{16,17}, Meredith Ward^{5,6}, Xiao Zhu^{10,18}, Amanda Gwee^{2,3,19}

¹Royal Children's Hospital, General Medicine, Parkville, Australia, ²The University of Melbourne, Department Of Paediatrics, Parkville, Australia, ³Murdoch Children's Research Institution, Infectious Disease Group, Parkville, Australia, ⁴The Children's Hospital at Westmead, Department Of Pharmacy, Westmead, Australia, ⁵Royal Hospital for Women, Department Of Newborn Care, Randwick, Australia, ⁶University of New South Wales, School Of Women's And Children's Health, Sydney, Australia, ⁷Royal Children's Hospital, Department Of Paediatric Intensive Care, Parkville, Australia, ⁸Murdoch Children's Research Institution, Royal Children's Hospital, Parkville, Australia, ⁹Royal Children's Hospital Melbourne, Infectious Diseases, Parkville, Australia, ¹⁰University of Otago, School Of Pharmacy, Dunedin, New Zealand, ¹¹Murdoch Children's Research Institution, Department Of Operations, Parkville, Australia, ¹²Monash Children's Hospital, Monash Newborn, Clayton, Australia, ¹³Department of Neonatal Medicine, Royal Children's Hospital, Parkville, Australia, ¹⁴Monash University, Department Of Paediatrics, Melbourne, Australia, ¹⁵Sydney Children's Hospital, Department Of Immunology And Infectious Diseases, Randwick, Australia, ¹⁶The Children's Hospital at Westmead, Grace Centre For Newborn Care, Westmead, Australia, ¹⁷The University of Sydney, Faculty Of Medicine And Health, Sydney, Australia, ¹⁸Fudan University, Department Of Clinical Pharmacy And Pharmacy Administration, Shanghai, China, ¹⁹Royal Children's Hospital, Infectious Diseases, Parkville, Australia

Backgrounds: In the majority of young infants, current empiric vancomycin dosing regimens fail to achieve the target concentrations required to treat sepsis. Individualised model-based dosing may improve attainment of therapeutic concentrations by accounting for the factors attributing to interindividual variability. This study assessed the performance of an online dosing calculator (Vanc App) based on a published pharmacokinetic model in achieving target trough vancomycin concentrations of 10 to 20 mg/L at first steady state level (24 to 48 hours) and an AUC₂₄ between 400 and 650 mg/L.h.

Methods: Multicentre study in four Australian tertiary paediatric hospitals over a 17-month period. Infants aged between 0 to 90 days of age with suspected Gram-positive sepsis were eligible. The Vanc App was used to generate a dose based on the infant's postmenstrual age (PMA), weight, creatinine level and target vancomycin trough concentration.

Results: Overall, 40 young infants were enrolled, 40% female with a median weight of 2505 (range 700-4460) grams and PMA 37.4 (range 25.7-49) weeks. The median recommended vancomycin dose using Vanc App was 44.5 (range 24 to 79) mg/kg/day. All infants had trough vancomycin concentrations measured at 24 hours and 30 (75%, 95% CI 62%-88%) achieved target trough concentrations, with five each having suprathereapeutic (3 between 20-25 mg/L and 2 >25 mg/L) and subtherapeutic concentrations. Target AUC₂₄ was achieved in 32 (80%) for AUC₀₋₂₄. There were no episodes of vancomycin infusion reaction or nephrotoxicity (defined as creatinine level >2 times baseline).

Conclusions/Learning Points: Individualised vancomycin dosing using a model-based online calculator resulted in 75% and 80% of young infants achieving target trough and AUC₂₄ targets, respectively at the first steady-state level with no significant vancomycin-related adverse effects.

O038 / #1004

ANTIBIOTIC THERAPY ON THE PAEDIATRIC ENVIN-HELICS DATA BASE

Oral Presentations Session

ORAL PRESENTATION SESSION 06: ANTIMICROBIALS & ANTIBIOTIC STEWARDSHIP

Elena Fresan-Ruiz¹, Mireia Mor-Conejo¹, Aina Covas¹, Ariadna Rubio¹, Carmina Guitart¹, Mònica Girona-Alarcon¹, Sara Bobillo-Perez¹, Juan Carlos De Carlos², María Slocker³, Iolanda Jordan¹, P Aediatric Envin Registry¹

¹Sant Joan de Déu Hospital, Paediatric Intensive Care Unit, Esplugues de Llobregat, Spain, ²Hospital Son Espases, Paediatric Intensive Care Unit, Palma de Mallorca, Spain, ³Hospital Gregorio Marañón, Paediatric Intensive Care Unit, Madrid, Spain

Backgrounds: Healthcare-associated infections (HAI) are a major public-health problem. The aim of this study is to compare the evolution of antibiotics used for HAI diagnosed in Paediatric Intensive Care Units (PICU) from the Spanish registry Paediatric-ENVIN-HELICS.

Methods: Multicentre, prospective and observational study of HAI diagnosed in 28 Spanish PICU, during a three-month period from 2014–2020. The ENVIN diagnostic criteria adapted to paediatrics were used, based on CDC recommendations.

Results: Total number of patients was 10972. In 2020 the rate of antibiotics use was 67%. Comparing 2020 with 2014, this rate decreased 12% ($p < 0.001$). The Antimicrobial Stewardship Programs (ASP) were implemented in 26 PICUs (92%) in 2020, compared with 9 (32%) in 2014. Comparing the last and the first year of the registry, antibiotic stewardship was 17.7% higher ($p < 0.001$). Early suspension antibiotic rate increased (2.4%, $p > 0.05$). Antibiotic modifications due to side effects decreased (0.9%), but modifications due to new resistances during treatment increased (0.1%), not statistically significant differences were found. There was an increase in meropenem use compared with the previous year ($p > 0.05$): for HAI previous PICU admission of 5.1% and for PICU HAI of 4.1%.

Conclusions/Learning Points: The rate of antibiotics use was high, but results showed a significant decrease during 2020. Despite the implementation of ASP, the use of carbapenems for HAI increased in 2020. The improvement in antibiotic use policies is evident thanks to the increase of antibiotic de-escalation and early suspension rate. In 2020 there was a reduction on the modifications of the antibiotic regime due to adverse events, but an upturn of the emergence of new resistant microorganisms.

O039 / #1021

IMPACT IN ANTIBIOTIC USE AFTER IMPLEMENTATION OF AN ANTIMICROBIAL STEWARDSHIP PROGRAM AND A JOINT PROTOCOL WITH ELECTRONIC PRESCRIPTION FOR APPENDICITIS/PERITONITIS IN PEDIATRICS

Oral Presentations Session

ORAL PRESENTATION SESSION 06: ANTIMICROBIALS & ANTIBIOTIC STEWARDSHIP

Serena Villaverde¹, José Manuel Caro², Patricia Brañas³, Rocío Morante⁴, Irene Gómez¹, Gloria Mirete¹, Cinta Moraleda¹, Daniel Blázquez-Gamero¹, Angela Manzanares¹, David Torres¹, Elisa Fernandez¹, Luis Prieto¹, Pablo Rojo¹, Cristina Epalza¹

¹HOSPITAL 12 DE OCTUBRE, Paediatrics, MADRID, Spain, ²HOSPITAL 12 OCTUBRE OCTUBRE, Farmacology, Madrid, Spain, ³HOSPITAL 12 OCTUBRE OCTUBRE, Microbiology, Madrid, Spain, ⁴HOSPITAL 12 OCTUBRE, Pediatric Surgery, Madrid, Spain

Backgrounds: Initial antibiotic treatment in appendicitis/peritonitis significantly reduces wound infection and intra-abdominal abscess formation in patients with gangrenous or perforated appendicitis. Randomized controlled trials have shown that the use of lower-spectrum antibiotic combinations is as effective in preventing abscesses or surgical wound infections as broad-spectrum regimens.

Methods: Observational, retrospective study of patients <16 years of age admitted for appendicitis and/or peritonitis from Jan/2014 to Dec/2019 in a tertiary university hospital in Madrid, Spain. Three study periods were established: P1 2014-2015 (before Antimicrobial Stewardship Programme (ASP)), P2 2016-2018 (ASP implemented) and P3 Jan/2019-Dec/2019 (ASP and implementation of an appendicitis/peritonitis protocol with electronic prescription, including lower-spectrum antibiotic combinations and selected and clinically guided use after surgery). Antimicrobial use was analysed with the days of therapy/1000 admissions days (DOT/1000) and start of treatment/1000 hospital admissions (SOT/1000).

Results: During the study period a total of 1619 patients met inclusion criteria. The proportion of patients without antibiotic therapy after surgery during P1, P2 and P3 was 5.6%, 3.7%, and 38.6% respectively. [C1] The evolution of antibiotic use expressed by DOT / 1000 is shown in Figure 1. SOT/1000 of ampicillin, gentamicin and metronidazole rose from 162, 190 and 190 in 2014 to 386, 402 and 409 in 2019. DOT/1000 of meropenem drop to 64.85 in 2014 to 0 in 2019.

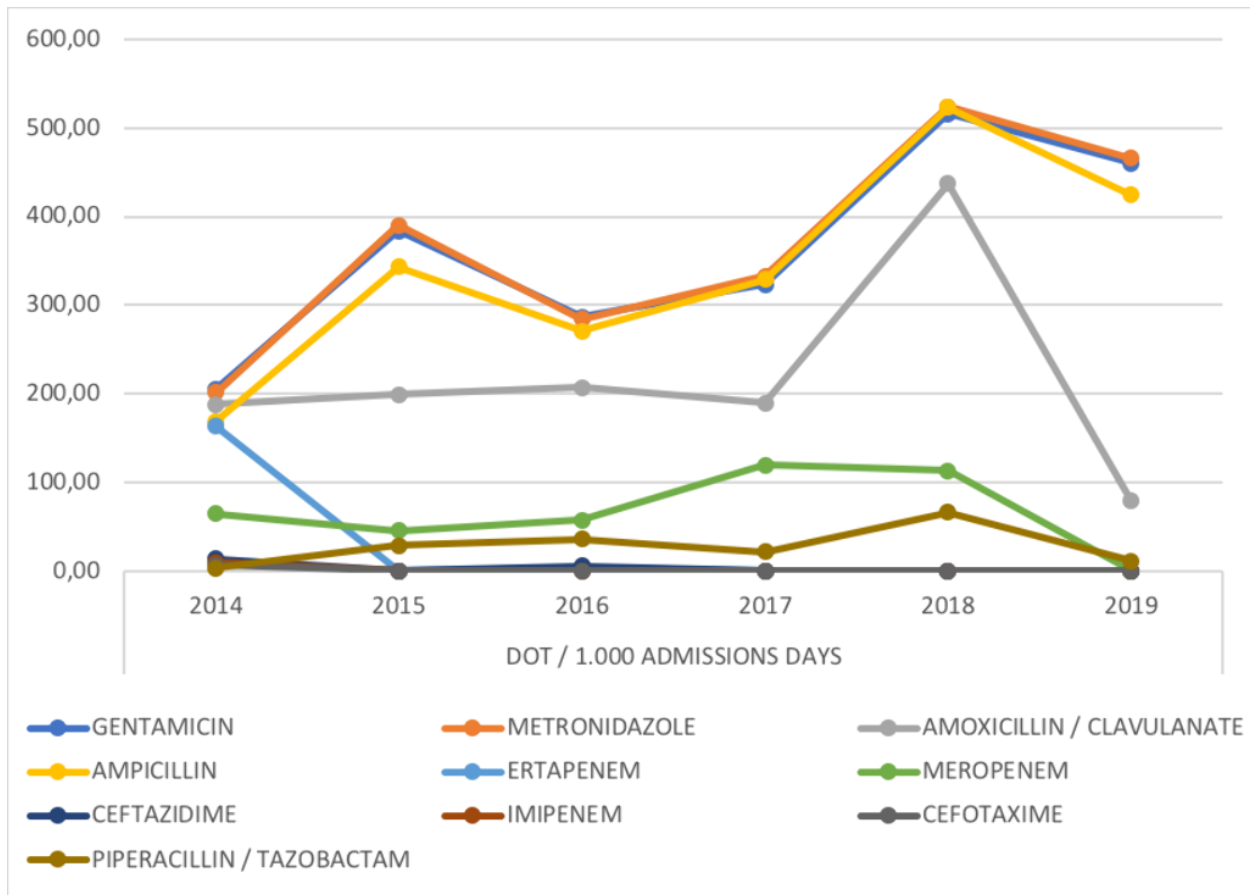

Conclusions/Learning Points: The implementation of an ASP and a low-spectrum antibiotic protocol with electronic prescribing, reduced the antimicrobial use in children with appendicitis/peritonitis. The proportion of patients without antibiotic therapy after surgery increased and the use of carbapenems and other broad-spectrum antibiotics was reduced after the intervention. These improvements were observed when an electronically available protocol was added to the ASP implementation.

O040 / #495

DURATION OF ANTIBIOTIC PRESCRIPTION AMONG YOUNG CHILDREN IN BRITISH COLUMBIA (BC), CANADA: ROOM FOR IMPROVEMENT

Oral Presentations Session

ORAL PRESENTATION SESSION 06: ANTIMICROBIALS & ANTIBIOTIC STEWARDSHIP

David Patrick^{1,2}, Max Xie², Nick Smith², Anastasiia Lisovskaia², Hannah Lishman^{1,2}, Lynsey Hamilton², S ade Stenlund^{1,2}, Fawziah Marra³, Abdullah Mamun²

¹University of British Columbia, Faculty Of Medicine, Vancouver, Canada, ²British Columbia Centre for Disease Control, Communicable Disease And Immunization Services, Vancouver, Canada, ³University of British Columbia, Faculty Of Pharmaceutical Sciences, Vancouver, Canada

Backgrounds: Antibiotic overuse, including unnecessary prescription as well as longer than necessary duration of therapy (DOT), contributes to antibiotic resistance. This study examined the DOT for common infections among children <10 years in BC, Canada.

Methods: In this population-based, retrospective cohort study, prescription and physician billing data generated during 2019 were anonymously linked to determine prescriptions associated with specific diagnoses for children < 10 years of age. These included community acquired pneumonia (CAP), acute otitis media (AOM), cystitis, acute bronchitis, pyelonephritis, and cellulitis. The linked data accounts for >85% community prescriptions with the remainder contributed by other professions who do not use the physician billing system. Median (Q1; first quartile, Q3; third quartile) DOT were examined for the study population, across select diagnoses and stratified by age (<1, 1–4 and 5–9), gender and antibiotic class.

Results:

Figure: Duration of prescription for different diagnosis among children <10 years in 2019, BC, Canada

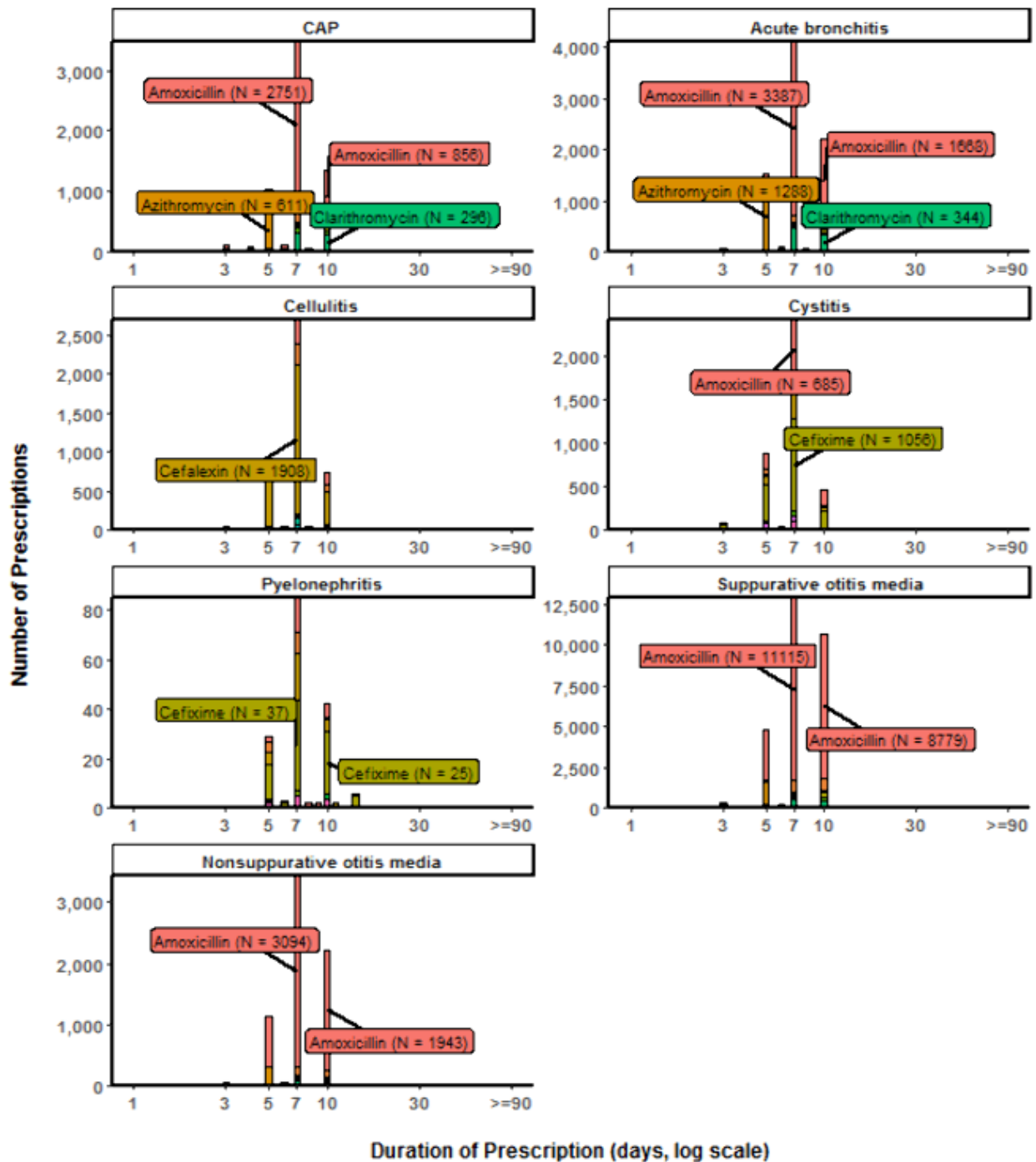

In 2019, the overall median (Q1, Q2) DOT, as well as for diagnoses of interest was 7 (7, 10) days. However, the DOT distribution skewed further right for AOM, cellulitis, cystitis and acute bronchitis. Median (Q1, Q3) DOT was 7 (7, 7) days for CAP, 7 (6, 7) days for cystitis, and 7 (7, 10) days for pyelonephritis, acute bronchitis, and suppurative and non-suppurative otitis media. Each DOT distribution was also informed by which antibiotic was used (see figure). For CAP and acute bronchitis, azithromycin was mostly prescribed for 5 days, whereas 26.9% amoxicillin was prescribed for ≥ 10 days. 84.6% amoxicillin prescribed for otitis media (suppurative and nonsuppurative) among children 5-9 years was ≥ 7 days.

Conclusions/Learning Points: Antibiotic DOT in children for many indications was longer than current guidelines. Opportunities are present to further reduce unnecessary antibiotic exposure by emphasizing shorter DOT where evidence supports equivalent outcomes.

O041 / #496

ANTIMICROBIAL ACTIVITY OF GOLD NANOPARTICLES COATED WITH CERAGENIN CSA-13 AGAINST HIGHLY-VIRULENT AND ANTIBIOTIC-RESISTANT ACINETOBACTER BAUMANNII

Oral Presentations Session

ORAL PRESENTATION SESSION 06: ANTIMICROBIALS & ANTIBIOTIC STEWARDSHIP

Karol Skłodowski¹, Sylwia Chmielewska¹, Łukasz Suprewicz², Tomasz Wollny³, Grzegorz Król⁴, Joanna Depciuch⁵, Magdalena Parlińska-Wojtan⁵, Paul B. Savage⁶, Robert Bucki¹

¹Medical University of Białystok, Department Of Medical Microbiology And Nanobiomedical Engineering, Białystok, Poland, ²Medical University of Białystok, Medical Microbiology And Nanobiomedical Engineering, Białystok, Poland, ³Holy Cross Oncology Center of Kielce, Holy Cross Oncology Center Of Kielce, Kielce, Poland, ⁴Jan Kochanowski University in Kielce, Department Of Microbiology And Immunology, Kielce, Poland, ⁵Polish Academy of Sciences, Institute Of Nuclear Physics, Krakow, Poland, ⁶Brigham Young University, Department Of Chemistry And Biochemistry, Provo, United States of America

Backgrounds: The overuse of antibiotics has led to the emergence of multidrug-resistant (MDR) and extensively drug-resistant (XDR) bacteria, and as a result very often we lack effective therapeutic options for infections caused by these strains. This study was designed to determine in vitro antimicrobial activities of nanosystems containing gold nanoparticles and ceragenin (cationic steroidal antimicrobial) CSA-13 against *Acinetobacter baumannii* strain.

Methods: The clinical strain (*A. baumannii* resistant to carbapenems, aminoglycosides and fluoroquinolones) was subjected to treatment with rod- (AuR), peanut- (AuP), and star-shaped (AuS) gold nanoparticles (Au NPs) coated with CSA-13. Minimal inhibitory and bactericidal concentrations, colony counting assays and a resazurin-based proliferation assays were used to determine bactericidal efficacy. Additionally, adherence and internalization of the pathogens to lung-derived cells (A549) as well as biocompatibility of the tested compounds were evaluated.

Results: AuR NPs@CSA-13, AuP NPs@CSA-13 and AuS NPs@CSA-13 shown high antimicrobial activity, regardless of the identified mechanism of drug resistance. Both internalization and adherence of the tested strain were restricted and dose-dependent in a cell culture model. Importantly, tested compounds at bactericidal concentrations were characterized by satisfactory biocompatibility.

Conclusions/Learning Points: The applied gold nanosystems exhibit strong antimicrobial activity against a MDR *A. baumannii* strain, which makes them promising agents to develop as new therapeutic options to eradicate multidrug-resistant pathogens.

The project was funded by the National Science Centre granted under contract number UMO-2018/31/B/NZ6/02476

O042 / #1087

THE RESULTS OF THE TIARA TRIAL- TREATING IMPETIGO WITH ANTISEPTICS, REPLACING ANTIBIOTICS: A RANDOMISED CONTROLLED TRIAL COMPARING TOPICAL TREATMENTS OF IMPETIGO

Oral Presentations Session

ORAL PRESENTATION SESSION 06: ANTIMICROBIALS & ANTIBIOTIC STEWARDSHIP

Sarah Primhak¹, Alicia Gataua², Diana Purvis³, Cameron Walker⁴, John Thompson¹, Alison Leversha⁵, Emma Best¹

¹University of Auckland, Paediatrics And Youth Health, Auckland, New Zealand, ²National Hauora Coalition, School Health, Auckland, New Zealand, ³Starship Children's Health, Dermatology, Auckland, New Zealand, ⁴University of Auckland, Engineering, Auckland, New Zealand, ⁵Starship Children's Health, Community Paediatrics, Auckland, New Zealand

Backgrounds: Impetigo is a superficial bacterial skin infection with a high incidence in New Zealand (NZ). Prescribing of topical antibiotic fusidic acid (FA) in NZ has induced FA resistance and selection of methicillin resistant *S. aureus* (MRSA). In response, antiseptics are replacing antibiotics, in both NZ and UK, despite limited evidence. This randomised single-blind non-inferiority trial compares topical FA with antiseptic (hydrogen peroxide) and with cleaning and covering the lesions.

Methods: Children aged 5-13 years, presenting to school health clinics in Auckland with mild-to-moderate impetigo were randomised to receive one of three treatments; FA, hydrogen peroxide or wound care for five days. Primary outcome was based on analysis of photographs taken before and after treatment, by three independent graders, blinded to treatment arm. Bacterial swabs were taken pre- and post-treatment.

Results: 84% (132/157) and 79% (134/169) of impetigo improved after 5 days of treatment with FA and antiseptic respectively. 64% (48/74) of those treated with wound care improved. Including all lesions, non-inferiority of antiseptic was not shown. Stratified-analysis of impetigo limited to a single body region, demonstrated non-inferiority of antiseptic compared to FA. Wound care was not shown to be non-inferior to FA. All treatments were acceptable with no severe adverse reactions. Higher rates of bacteria were seen on lesions following treatment with antiseptic and clean and cover than FA.

Conclusions/Learning Points: Overall antiseptic is neither inferior or non-inferior to topical antibiotics. However, it is non-inferior where impetigo is limited to a single region of the body. Wound care is inferior to FA. Although antiseptic produced clinical resolution for most, higher rates of bacteria remain following treatment with antiseptic. Questions remain over whether this has clinical impact such as recurrence, subsequent skin-related admission or future risks of post-streptococcal phenomena.

O043 / #1065

PATTERNS AND TRENDS OF ANTIBACTERIAL AND ANTIFUNGAL USE IN A PEDIATRIC ONCOLOGY DEPARTMENT

Oral Presentations Session

ORAL PRESENTATION SESSION 06: ANTIMICROBIALS & ANTIBIOTIC STEWARDSHIP

Evgenia Rouka¹, Evgenia Papakonstantinou², Elisavet Chorafa¹, Eleni Ifigenia Christou³, Elias Iosifidis¹, Emmanuel Roilides¹

¹Aristotle University of Thessaloniki, Infectious Diseases Unit, 3rd Pediatric Department, Thessaloniki, Greece, ²Hippokration Hospital of Thessaloniki, Pediatric Oncology Department, Thessaloniki, Greece, ³hippokration Hospital of Thessaloniki, Hospital Pharmacy, Thessaloniki, Greece

Backgrounds: Monitoring of antibacterial and antifungal use is essential for antimicrobial stewardship strategies. We studied patterns and time trends of antibacterial and antifungal use in a pediatric oncology department.

Methods: A retrospective analysis of monthly antibacterial and antifungal use was conducted in a 20-bed pediatric oncology department of a tertiary-level hospital from January 2018 to May 2020 (29 months). Data of antimicrobial and antifungal consumption was obtained from the hospital pharmacy and expressed as defined daily doses per 100 bed-days (DDD/100BD). Number of bed-days was obtained from Hospital Office of Statistics.

Results: During study period there was a median monthly rate of 301 bed-days. Total consumption of antibacterials had a median monthly rate of 108 DDD/100BD and of antifungals 94 DDD/100BD showing significant increases ($p=0.015$ and $p<0.001$, respectively). Glycopeptides (vancomycin/teicoplanin) constituted the most common used antibacterial class (29.5 DDD/100BD). Carbapenems were the second most used antibacterial agents (15.2 DDD/100BD) with a significant increase ($p=0.009$). Consumption of aminoglycosides and combination of piperacillin with tazobactam followed with 13.8 DDD/100BD and 11.7 DDD/100BD, respectively. Consumption of cotrimoxazole was 9.3 DDD/100BD, followed by metronidazole (6.4 DDD/100BD), colistin (4 DDD/100BD) and quinolones (3.8 DDD/100BD). Utilization of 3rd generation cephalosporins was relatively low (3.7 DDD/100BD). Voriconazole constituted the most common used antifungal agent (45 DOT/100BD). Micafungin was the second most commonly used antifungal agent (18 DOT/100BD) with a significant increase ($p=0.028$).

Conclusions/Learning Points: High consumption of glycopeptides and carbapenems combined by constant use of colistin is of concern. Emergence of antimicrobial resistance in pediatric oncology patients could explain this pattern. High voriconazole and micafungin use mainly reflects antifungal prophylaxis practices. These results may guide antimicrobial and antifungal stewardship activities.

O044 / #319

RISK FACTORS FOR IN-PATIENT MORTALITY IN CHILDREN ADMITTED TO HOSPITAL WITH SEVERE ACUTE MALNUTRITION (SAM) IN ZIMBABWE AND ZAMBIA: ONGOING RISKS FROM INFECTIOUS CAUSES

Oral Presentations Session

ORAL PRESENTATION SESSION 07: GLOBAL HEALTH & HIV & TB

Jonathan Sturgeon^{1,2}, Wadzanai Mufukari², Joice Tome², Cherlynn Dumbura², Florence Majo², Kanta Chandwe³, Robert Ntozini², Mutsa Bwakura-Dangarembizi², Beatrice Amadi³, Paul Kelly³, Andrew Prendergast^{1,2}

¹Queen Mary University of London, Centre For Genomics And Child Health, E AT, United Kingdom, ²Zvitambo Institute for Maternal and Child Health Research, , Harare, Zimbabwe, ³Tropical Gastroenterology and Nutrition Group, Tropgan, Lusaka, Zambia

Backgrounds: Severe acute malnutrition (SAM) is the most extreme form of malnutrition, necessitating hospitalization if the child has severe oedema, infection, or lack of appetite. Mortality continues to remain unacceptably high for hospitalized children, with deaths frequently being attributed to infectious causes.

Methods: Children with SAM aged <60 months were enrolled after admission at two tertiary referral hospitals in Harare, Zimbabwe, and one in Lusaka, Zambia between August 2016 and March 2018. Children had baseline data and anthropometry collected and were assessed by a doctor daily to document diagnoses. Independent risk factors associated with mortality were determined using backwards stepwise Cox regression.

Results: 70 of 745 (9.4%) children died in hospital, mean time to death 9.9 days. Age between 6-23 months [adjusted hazard ratio 6.53, 95%CI 2.24 – 19.02], presence of shock [aHR 8.18, 95%CI 3.79 – 17.65], sepsis [aHR 3.13, 95%CI 1.44 – 6.80], persistent diarrhoea [aHR 2.27, 95%CI 1.18 – 4.37], lack of a household toilet [aHR 4.35, 95%CI 1.65 – 11.47], mid-upper arm circumference [aHR 0.726, 95%CI 0.591 – 0.892] and oedema [aHR 2.22, 95%CI 1.23 – 4.05] were all independent risk factors for in-patient mortality [Figure 1A-E]. HIV was not independently associated with mortality, although there was a significant interaction with shock: children with HIV were 6.21 times more likely to be shocked (95%CI 1.41 – 27.2) than HIV-ve children.

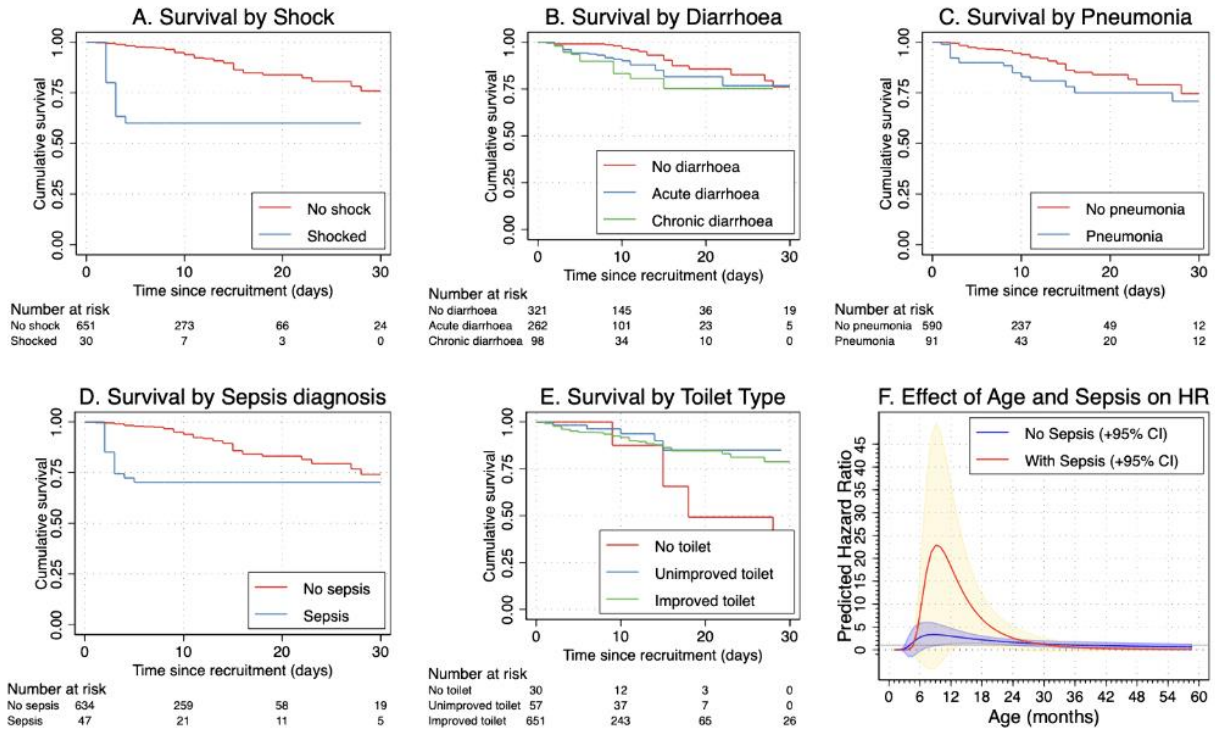

Conclusions/Learning Points: In this largest prospective study of children with SAM since WHO guidelines were introduced, sepsis, shock, persistent diarrhoea, and household sanitation are all independent predictors of hospital mortality, showing importance of infection in inpatient deaths, despite universal antibiotic administration. HIV, associated with mortality in several previous studies of SAM, was not independently associated with mortality. (Ethical approval/informed consent obtained)

O045 / #1256

NEONATAL MACROPHAGES HAVE ALTERED IMMUNOMETABOLIC RESPONSES TO MYCOBACTERIUM TUBERCULOSIS WHICH ARE MODIFIED BY IFN- γ , IL-4 OR LACTATE

Oral Presentations Session

ORAL PRESENTATION SESSION 07: GLOBAL HEALTH & HIV & TB

Cilian Ó Maoldomhnaigh, Donal Cox, James Phelan, Joseph Keane, Sharee Basdeo
Trinity Translational Medicine Institute, Tb Immunology, Dublin, Ireland

Backgrounds: Tuberculosis (TB) is the biggest global infectious killer in the last decade and young children are especially vulnerable. Mycobacterium tuberculosis (Mtb), the bacteria that causes TB, is phagocytosed by macrophages. To mount an appropriate immune response, the macrophage needs to alter metabolism, increasing glycolysis and decreasing oxidative phosphorylation (Warburg effect). It was hypothesized that umbilical cord derived macrophages have an altered immunometabolic response compared with adult macrophages, which may explain infant susceptibility to TB.

Methods: Monocyte derived macrophages (MDM) were derived from buffy coats or from umbilical cord blood prior to analysis in the XFe Seahorse analyzer. TNF in supernatant was measured by Mesoscale Discovery assay.

Results: The Warburg effect was demonstrated in adult MDM after Mtb stimulation. Cord blood MDM however, did not decrease OXPHOS (Figure, A). Cord blood MDM secreted less TNF than adult MDM following Mtb stimulation (Figure, B). The effects of IFN- γ or IL-4 on macrophage immunometabolism was investigated. IFN- γ increased glycolysis and OXPHOS and IL-4 markedly reduced glycolysis. IFN- γ increased cord TNF production in response to Mtb, equating to adult levels (Figure, C). IL-4 caused a decrease in IL-1 β production in Mtb stimulated MDM. A consequence of raised glycolysis is increased extracellular lactate. The addition of exogenous lactate has an immediate effect on metabolism, decreasing glycolysis and increasing OXPHOS. Lactate significantly reduced the concentrations of TNF produced in response to Mtb (Figure, D). In addition, lactate significantly improved bacillary clearance in adult macrophages infected with Mtb.

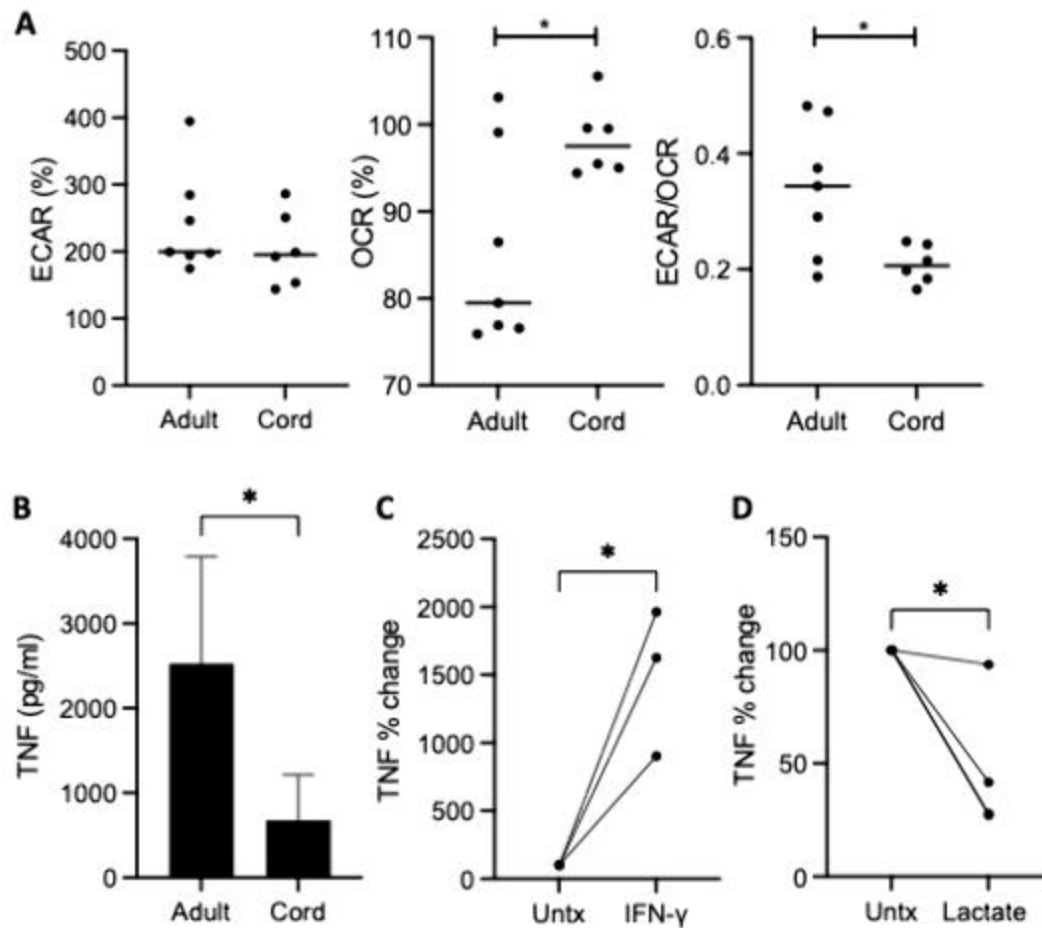

Figure: The altered immunometabolic response of neonatal macrophages to *Mycobacterium tuberculosis* is modified by IFN- γ , IL-4 or lactate PBMC were isolated from buffy coats or from umbilical cord blood samples taken immediately following delivery. Adult or cord blood MDM were adherence purified for 7 days in 10% human serum. MDM were washed and detached from the plates by cooling and gentle scraping, counted and re-seeded on Seahorse culture plates prior to analysis in the Seahorse XFe24 Analyzer. Mtb (IH37Rv; MOI 1-10) were added to the cells in the Seahorse Analyzer. The Extracellular Acidification Rates (ECAR) and Oxygen Consumption Rate (OCR) and ECAR/OCR ratio were calculated 150 minutes after stimulation (**A**). 24 hours after stimulation with Mtb, TNF in supernatant was measured by Mesoscale Discovery assay from adult and cord blood MDM (**B**) and from cord blood MDM that had been pre-treated with IFN- γ (**C**) or lactate (**D**). Statistically significant differences were determined using a paired (C,D) or unpaired (B) Student's t test and one-way ANOVA (A), as appropriate; *P < 0.05.

Conclusions/Learning Points: These data indicate that adult and cord blood macrophages exhibit distinct immunometabolic function upon stimulation which may underlie their differential ability to respond to infection and inform therapeutic strategies for host-directed therapies for TB.

O046 / #877

ANTENATAL CMV VIRAEMIA AND MORTALITY OF CHILDREN BORN TO MOTHERS WITH HIV IN RURAL ZIMBABWE

Oral Presentations Session

ORAL PRESENTATION SESSION 07: GLOBAL HEALTH & HIV & TB

Ceri Evans^{1,2}, Bernard Chasekwa², Kuda Mutasa², Sandra Rukobo², Margaret Govha², Patience Mushayanembwa², Florence Majo², Naume Tavengwa², Jean Humphrey^{2,3}, Robert Ntozini², Andrew Prendergast^{1,2,3}

¹Queen Mary University of London, Blizard Institute, London, United Kingdom, ²Zvitambo Institute for Maternal and Child Health Research, Harare, Zimbabwe, ³Johns Hopkins, Bloomberg School Of Public Health, Maryland, United States of America

Backgrounds: Despite falling vertical transmission rates globally, children born to mothers living with HIV have higher mortality than children born to mothers without HIV. We tested the hypothesis that antenatal cytomegalovirus (CMV) viraemia is associated with this excess mortality.

Methods: Women from the SHINE trial in rural Zimbabwe (ClinicalTrials.gov registration number NCT01824940) were recruited during pregnancy and infants were followed for 18 months. Antenatal CMV DNA was quantified by real-time PCR at a median gestation of 16-weeks. Cox regression models were used to estimate hazard ratios (HR) for mortality.

Results: Among 563 women with HIV, 69% had no detectable CMV (group 1), 24% had a CMV viral load below 45 copies/mL (group 2), 7% had a CMV viral load 45 copies/mL or greater (group 3). For each log rise in antenatal CMV viral load, risk of child death by 18 months of age increased by 14%, after adjusting for maternal HIV viral load and CD4 count, gestational age at blood sampling and randomised trial arm (adjusted HR (aHR) 1.14; 95%CI 1.04, 1.25; P=0.007). Risk of mortality of children in group 1 was similar to 3989 children born to mothers without HIV (5.1% vs. 5.0%; aHR 0.99; 95%CI 0.60, 1.61; P=0.96). Risk of mortality of children in group 2 was 1.75-fold higher than children born to mothers without HIV (8.8% vs. 5.0%; aHR 1.75; 95%CI 1.00, 3.07; P=0.05) and in group 3 was 4-fold higher (21.1% vs. 5.0%; aHR 4.14; 95%CI 2.10, 8.16; P<0.001) than children born to mothers without HIV.

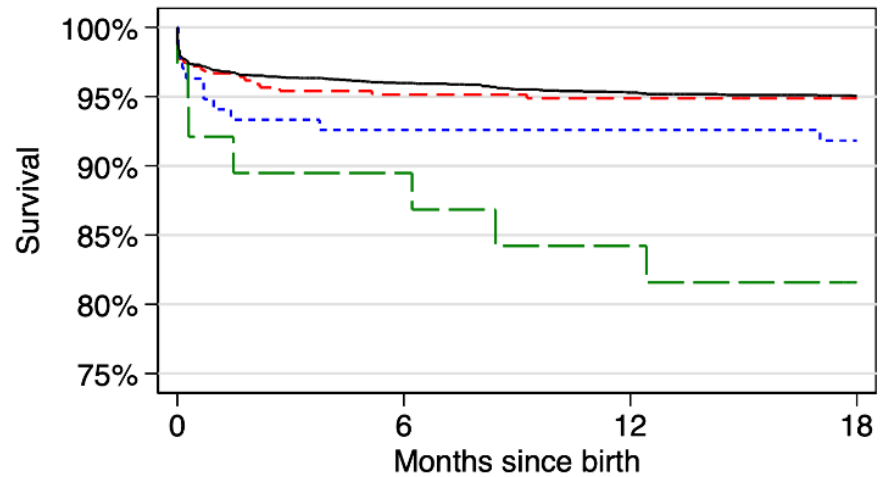

| Number at risk | | | | |
|-----------------------------------|------|------|------|------|
| HIV-unexposed | 3989 | 3753 | 3713 | 2657 |
| HIV-exposed, CMV undetectable | 396 | 367 | 365 | 247 |
| HIV-exposed, CMV VL <45 copies/mL | 137 | 125 | 122 | 84 |
| HIV-exposed, CMV VL >45 copies/mL | 38 | 34 | 32 | 21 |

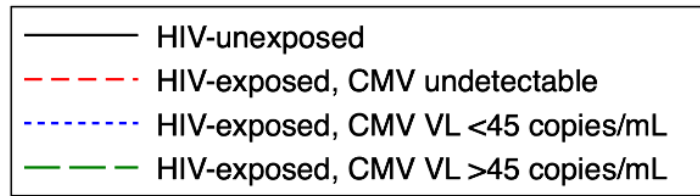

Conclusions/Learning Points: Antenatal CMV viraemia is associated with mortality of HIV-exposed children. Identifying and treating CMV viraemia during pregnancy may provide a new target for improving clinical outcomes amongst children born to mothers with HIV.

THE IMMUNE PROFILE OF LOW BIRTH WEIGHT INFANTS IN RURAL ZIMBABWE

Oral Presentations Session

ORAL PRESENTATION SESSION 07: GLOBAL HEALTH & HIV & TB

Jonathan Broad¹, Claire Bourke¹, Ceri Evans¹, Bernard Chasekwa², Christie Noble¹, Kuda Mutasa³, Sandra Rukobo³, Margaret Govha³, Patience Mushayanembwa³, Florence Majo³, Naume Tavengwa², Jean Humphrey⁴, Robert Ntozini², Andrew Prendergast⁵

¹Queen Mary University of London, Blizard Institute, London, United Kingdom, ²Zvitambo Institute for Maternal and Child Health Research, Research, Harare, Zimbabwe, ³Zvitambo Institute for Maternal and Child Health Research, Laboratory, Harare, Zimbabwe, ⁴Johns Hopkins, Bloomberg School Of Public Health, Maryland, United States of America, ⁵Queen Mary University of Lonon, Centre For Genomics And Child Health, E AT, United Kingdom

Backgrounds: Low birthweight (LBW) infants, encompassing those born small-for-gestational age (SGA) and/or preterm, have poor health outcomes in developing countries, including increased risk of vaccine failure, infection and death. The role of immune development and inflammation remain poorly understood in LBW infants. This study aimed to ascertain biomarkers of enteropathy, T-cell activation and systemic inflammation associated with LBW.

Methods: Using stored samples from a large cluster-randomised trial in rural Zimbabwe, we measured biomarkers of enteropathy and systemic inflammation using ELISA, and T-cell activation by flow cytometry, comparing: (i) term, appropriate for gestational age (AGA); (ii) preterm, AGA; (iii) term, SGA; and (iv) preterm SGA. We used generalised estimating equations and generalised linear models to explore differences between groups.

Results: We include data from 1574 infants with visits at 1-3 months of age. Faecal biomarkers of intestinal inflammation were associated with LBW: compared to term AGA infants, neopterin was raised in premature SGA infants (mean 7.54nmol/L vs. 6.67nmol/L; $P<0.01$); myeloperoxidase was raised in premature AGA infants (8.11 ng/ml vs. 7.95; $P=0.01$); and alpha-1 antitrypsin was raised in premature AGA infants (13.60ng/ml vs.13.04ng/ml; $p=0.03$). Compared to term AGA infants, term SGA infants had higher proportions of activated (HLA-DR+) and proliferating (Ki67+) CD4+ T-cells (13.4% vs. 7.9% ($P<0.01$) and 8.0% vs. 3.2% ($P=0.02$), respectively). These effects were consistent after adjusting for plausible confounders. There were no differences in C-reactive protein between groups.

Conclusions/Learning Points: We identified associations between LBW, intestinal inflammation and T-cell activation, with prematurity having greater association with gut inflammation and SGA with lymphocyte activation. Mechanistic studies are needed to determine whether these pathways might be amenable to intervention to improve clinical outcomes among LBW infants.

O048 / #515

HOST-BASED BIOMARKERS IN SALIVA FOR THE DIAGNOSIS OF PULMONARY TUBERCULOSIS IN CHILDREN

Oral Presentations Session

ORAL PRESENTATION SESSION 07: GLOBAL HEALTH & HIV & TB

Nisreen Khambati¹, Laura Olbrich², Jerrold Ellner³, Padmini Salgame³, Rinn Song⁴, Else Bijker⁴

¹Royal Berkshire NHS Foundation Trust, Paediatrics, Oxford, United Kingdom, ²Division of Infectious Diseases and Tropical Medicine, University Hospital, Lmu, Munich, Germany, ³Rutgers, New Jersey Medical School, Department Of Paediatrics, Newark, United States of America, ⁴Oxford Vaccine Group, University of Oxford, Oxford, UK, Department Of Paediatrics, Oxford, United Kingdom

Backgrounds: The diagnosis of pulmonary tuberculosis (TB) remains difficult in young children. Rapid biomarker-based tests using non-sputum samples are needed. The role of biomarkers in saliva for diagnosing TB in children has not been fully explored.

Methods: We conducted a review of available studies on the use of host-based salivary biomarkers for diagnosing active pulmonary TB in children and adults.

Results: We found nine studies on salivary host diagnostic biomarkers, one of which involved children. Three studies evaluated the diagnostic performance of antibodies in saliva to antigens of *Mycobacterium tuberculosis*, with disappointing results. Six studies measured salivary levels of selected cytokines, growth factors, enzymes and other proteins and found that combinations of these markers showed potential in reaching WHO-endorsed performance criteria for a TB triage test. An eight-marker biosignature comprising of salivary granzyme A, growth differentiation factor 15, serum amyloid A, epithelial-neutrophil activating peptide 78, plasminogen activator inhibitor-1, IL-12(p40), IL-13 and IL-21, was most promising and had a sensitivity of 93% and specificity of 100%.¹ (1) Jacobs et al. Diagnostic Potential of Novel Salivary Host Biomarkers as Candidates for the Immunological Diagnosis of Tuberculosis Disease and Monitoring of Tuberculosis Treatment Response. PLoS One. 2016.

Conclusions/Learning Points: Saliva could be a valuable diagnostic specimen for diagnosing pulmonary TB in children, however little research in this population exists. Based on adult data, combinations of cytokines and other proteins demonstrate promise as new triage tests for TB. Given the differing TB immune response in children, studies in paediatric populations are now needed. The ready availability of saliva and non-invasive nature of collection is especially appealing for young children. Future directions and suggestions for technologies for salivary biomarker discovery and point-of-care test development are discussed.

FUJILAM FOR THE DIAGNOSIS OF CHILDHOOD TUBERCULOSIS: A SYSTEMATIC REVIEW

Oral Presentations Session

ORAL PRESENTATION SESSION 07: GLOBAL HEALTH & HIV & TB

Nisreen Khambati¹, Laura Olbrich², Else Bijker³, Morten Ruhwald⁴, Norbert Heinrich², Rinn Song³

¹Royal Berkshire NHS Foundation Trust, Paediatrics, Oxford, United Kingdom, ²Division of Infectious Diseases and Tropical Medicine, University Hospital, Lmu, Munich, Germany, ³Oxford Vaccine Group, University of Oxford, Oxford, UK, Department Of Paediatrics, Oxford, United Kingdom, ⁴FIND, Find, Geneva, Switzerland

Backgrounds: Despite recent advances in diagnostics, childhood tuberculosis (TB) remains underdiagnosed. The novel lateral flow FujilAM assay detects lipoarabinomannan (LAM) in urine and its sensitivity for the diagnosis of pulmonary TB was found to be higher compared to AlereLAM in adults. However, data on its performance in children is limited.

Methods: We conducted a systematic review assessing the diagnostic performance of FujilAM for diagnosing paediatric TB, using AlereLAM as a comparator. The last search was conducted in November 2021.

Results: We identified three studies with data from 698 children for FujilAM and 619 for AlereLAM. For FujilAM, pooled sensitivity and specificity using a microbiological reference standard (MRS) were 51% (95%CI 43-59) and 87% (95%CI 84-90), respectively, and 27% (95%CI 23-32) and 87% (95%CI 82-90) using a composite reference standard (CRS). For AlereLAM, sensitivity and specificity were 41% (95%CI 33-50) and 83% (95%CI 79-86) for MRS, and 32% (95%CI 27-37) and 88% (95%CI 84-92) for CRS. Subgroup analyses for FujilAM suggested an increased sensitivity in children living with HIV, especially when immunocompromised.

Figure 1: Forest plots of performance of lateral flow LAM assays against MRS and CRS

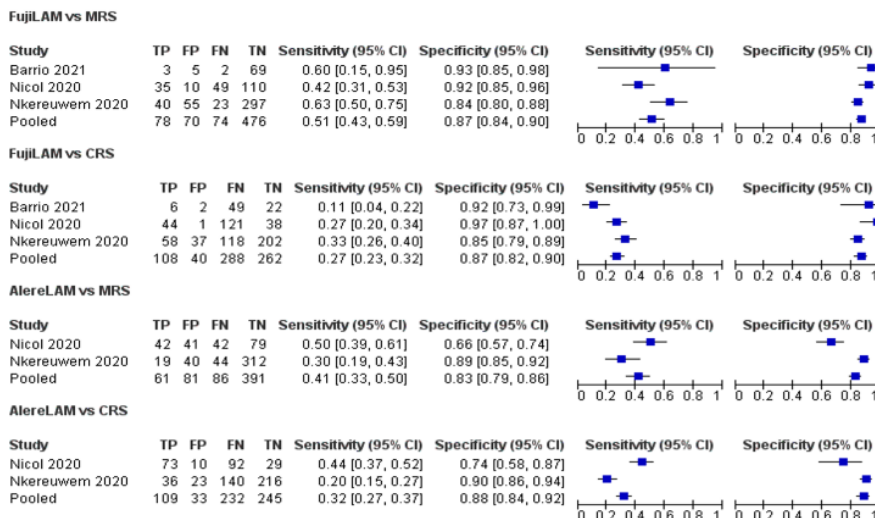

Conclusions/Learning Points: This is the first systematic review of the diagnostic performance of FujilAM in children, indicating a moderate but potentially superior sensitivity compared to AlereLAM. Our review emphasizes the points to be addressed in forthcoming evaluations, namely the need for prospective assessments from several geographical regions, rigorous application of reference standards, and specific subgroup analyses in children living with HIV and extrapulmonary TB. As an instrument-free

point-of-care test that uses an easy to obtain specimen, FujiLAM has the potential to improve TB diagnosis in children, particularly in low-resource settings.

VACCINATION COVERAGE AND ITS DETERMINANTS AMONG CHILDREN IN CAMBODIA, MADAGASCAR, AND SENEGAL

Oral Presentations Session

ORAL PRESENTATION SESSION 07: GLOBAL HEALTH & HIV & TB

Florian Verrier^{1,2}, Agathe De Lauzanne³, Perlinot Herindrainy⁴, Jean-Baptiste Diouf⁵, Zo Andrianirina Zafitsara⁶, Lison Ramblière¹, Touch Sok⁷, Myriam Landau⁴, Laurence Borand³, Fatoumata Sarr⁸, Muriel Vray^{1,9}, Jean-Marc Collard¹⁰, Elsa Kermorvant-Duchemin¹¹, Elisabeth Delarocque-Astagneau², Didier Guillemot^{1,2}, Bich-Tram Huynh^{1,2}

¹Institut Pasteur, Global Health, Paris, France, ²INSERM-UVSQ-Univ Paris-Saclay, Cesp, Montigny-Le-Bretonneux, France, ³Institut Pasteur du Cambodge, Epidemiology Unit, Phnom Penh, Cambodia, ⁴Institut Pasteur de Madagascar, Epidemiology Unit, Antananarivo, Madagascar, ⁵Centre Hospitalier Roi Baudouin, Pédiatrie, Dakar, Senegal, ⁶Centre Hospitalier de Soavinandriana, Pediatric Ward, Antananarivo, Madagascar, ⁷Ministry of Health, Cdc, Phnom Penh, Cambodia, ⁸Institut Pasteur de Dakar, Epidemiology Unit, Dakar, Senegal, ⁹Institut Pasteur de Dakar, Epidemiology Unit, Dakar, France, ¹⁰Institut Pasteur de Madagascar, Unité De Bactériologie Expérimentale, Antananarivo, Madagascar, ¹¹Assistance Publique-Hôpitaux de Paris, Université Paris Descartes, Hôpital Universitaire Necker-enfants Malades, Paris, France

Backgrounds: Vaccination reduces infectious diseases burden, the leading cause of under-five mortality, occurring mainly in low- and middle-income countries (LMICs). The latest Global Vaccine Action Plan has set a target of 90% immunisation coverage for all vaccines included in national programmes by 2020. We aimed to estimate immunisation coverage among children in Madagascar, Cambodia, and Senegal and to identify determinants associated with incomplete immunisation.

Methods: We used data from a child cohort (BIRDY cohort, 2012-2018) conducted both in urban and rural areas of these 3 countries. Children were followed-up from birth up to the age of 24 months with at least one home visit monthly. Immunizations received since the last visit were collected after verification in the child's vaccination card. Risk factor analysis was performed with logistic regression models.

Results: Among the 3606 children followed-up, all vaccine coverages were below the 90% threshold, except for BCG vaccine coverage in Cambodia. They were higher for vaccines recommended at birth and a decrease in coverage with age was observed for vaccines requiring several doses in all countries. For example, the decrease in coverage between the first and the third dose of pentavalent vaccine ranged from 20% to 40% ($p < 0.001$). Low birth weight ($< 2500\text{g}$) was an important risk factor for non-vaccination for vaccines recommended at birth (BCG and oral polio vaccine) in all three countries (aOR ranging from 1.93 [1.11-3.38] to 4.28 [1.85-9.37]). Also, high maternal education (from 0.38 [0.24-0.60] to 0.61 [0.38-0.97]) and high antenatal care attendance (from 0.39 [0.25-0.63] to 0.66 [0.52-0.84]) were identified as protective factors.

Conclusions/Learning Points: Vaccination coverage is still low in these countries. A multi-disciplinary approach is needed to improve coverage and thus reduce the burden of vaccine-preventable infectious diseases in LMICs.

O051 / #452

COMMUNITY-ACQUIRED BACTEREMIA AMONG HIV-INFECTED CHILDREN HOSPITALIZED WITH FEVER IN MOZAMBIQUE

Oral Presentations Session

ORAL PRESENTATION SESSION 07: GLOBAL HEALTH & HIV & TB

Darlenne Binti Kenga¹, Troy Moon², Fabião Maússe³, Samuel Simbine³, Alice Manjate³, Moshin Sidat⁴, Jahit Sacarlal³

¹Eduardo Mondlane University, Microbiology, Maputo, Mozambique, ²Vanderbilt University, Department Of Pediatrics, Division Of Pediatric Infectious Diseases, Nashville, United States of America, ³Eduardo Mondlane University, Department Of Microbiology, Faculty Of Medicine, Maputo, Mozambique, ⁴Eduardo Mondlane University, Department Of Community Health, Faculty Of Medicine, Maputo, Mozambique

Backgrounds: Bacteremia is a major cause of morbidity and mortality worldwide with a high disease burden in developing countries. Children with HIV frequently present with bacteremia that differs in severity and frequently leads to poor outcomes. Access to a microbiology laboratory is limited in many LMIC. In Mozambique, blood culture capacity is only available at select hospitals or research centers with little impact on patient care. National antimicrobial resistance monitoring is limited.

Methods: We conducted an observational study of HIV-infected children, aged 0-59 months, hospitalized with fever between April 2016 and February 2019. A single bacterial culture was collected at admission. Descriptive statistics were used to summarize microorganisms detected and antibiotic susceptibility testing.

Results: A total of 730 HIV-infected children were enrolled. Blood culture positivity was 12% (n=87) (95% CI: 9.9%-14.4%). Five organisms predominated: Staphylococcus aureus (37%), Klebsiella spp (11%), Salmonella spp (11%), Escherichia coli (9%) and Micrococcus (7%). Nearly 70% of Staphylococcus aureus were methicillin-resistant and roughly 50% of Klebsiella had ESBL production. An additional 146 blood cultures grew Coagulase-negative staphylococcus (CoNS). Originally felt to be contamination, however in subsequent analysis, CoNS showed a statistically significant association with clinical respiratory symptoms compared to other organisms (aOR 1.66, 95% CI: 1.15, 2.41, p=0.03).

Conclusions/Learning Points: Community-acquired bacteremia was common in HIV-infected children hospitalized in Mozambique with a fever. High rates of MRSA and ESBL producing organisms have implications for empiric antibiotics utilized in Mozambique. National laboratory capacity providing consistent and high-quality data on antimicrobial prevalence and their antibiotic susceptibility patterns is badly needed to guide policy for drug formulary expansion and antibiotic prescription guidelines. Focused studies should be done to better determine the pathogenic potential of CoNS in this context.

THE EFFECT OF HIV-EXPOSURE ON SCHOOL-AGE HEALTH OUTCOMES IN RURAL ZIMBABWE

Oral Presentations Session

ORAL PRESENTATION SESSION 07: GLOBAL HEALTH & HIV & TB

Joseph Piper^{1,2}, Clever Mazhanga¹, Idah Mapurisa¹, Tsitsi Mashedze¹, Eunice Munyama¹, Gloria Mapako¹, Thombizodwa Mashiri¹, Dzidzai Matemavi¹, Maria Kuona¹, Kundai Sibanda¹, Dzivaidzo Chidhangaro³, Naume Tavengwa³, Lisa Langhaug³, Robert Ntozini³, Marian Mwapaura³, Eddington Mpofu³, Batsirai Mutasa³, Melissa Gladstone⁴, Jonathan Wells⁵, Melanie Smuk², Jean Humphrey⁶, Andrew Prendergast²

¹Zvitambo Institute of Maternal and Child Health, Field Research, Harare, Zimbabwe, ²Queen Mary University of London, Genomics And Child Health, London, United Kingdom, ³Zvitambo Institute for Maternal and Child Health Research, Research, Harare, Zimbabwe, ⁴University of Liverpool, Department Of Translational Medicine, Liverpool, United Kingdom, ⁵UCL GOS Institute of Child Health, Global Nutrition, London, United Kingdom, ⁶Johns Hopkins, Bloomberg School Of Public Health, Maryland, United States of America

Backgrounds: It is unclear whether there are persistent school-age health, growth and developmental disparities between children who are HIV-exposed but uninfected (CHEU) versus HIV-unexposed (CHU). Long-term follow up of a cohort of children recruited to the SHINE trial, who are now aged 7-8 years, offers the opportunity to compare school-age outcomes in a setting where 15% of children are HIV-exposed.

Methods: We measured physical function using handgrip strength, broad jump and the shuttle run test to provide a standardized score. Cognitive function was evaluated using the Kaufman Assessment Battery for Children (KABC-II), with additional tools measuring executive function, literacy, numeracy, fine motor skills and socioemotional function. Growth was assessed by anthropometry, body composition (using bioimpedance analysis) and skinfold thicknesses. A detailed caregiver questionnaire measured demographics, socioeconomic status, nurturing, child discipline, food and water insecurity. Results for CHEU and CHU were compared using generalized estimating equations with an exchangeable working correlation structure to account for clustering.

Results: 328 rural Zimbabwean children (89 CHEU, 239 CHU) were assessed at age 7-8 years. CHEU were 2 months older than CHU (95%CI, 1mo to 3mo, $p < 0.001$), and had marginally reduced height-for-age Z-score, HAZ (-0.22, 95% CI -1.89, 0.01 $p = 0.06$). CHEU had significantly reduced total KABC-II scores (-4.6 marks, 95%CI -6.8, -2.3; $p < 0.001$) and weak evidence for reduced literacy and numeracy scores (-5 marks, 95%CI -11, 1; $p = 0.10$). CHEU had slightly higher socioemotional issues as measured by the strength and difficulties questionnaire (1.4 marks, 95% CI -0.04, 2.86, $p = 0.06$).

Conclusions/Learning Points: Our results indicate that antenatal HIV exposure has a persistent effect on CHEU growth and neurodevelopment at age 7 years, particularly for cognitive function.

O053 / #1296

HIGH UPTAKE OF HPV VACCINATION IN ADOLESCENT BOYS ONE YEAR AFTER ITS IMPLEMENTATION IN FLANDERS (BELGIUM)

Oral Presentations Session

ORAL PRESENTATION SESSION 08: PUBLIC HEALTH & NON-RESPIRATORY INFECTIONS

Laura Willen¹, Kirsten Maertens¹, Cécile Guérin², Marlou De Kroon², Pierre Van Damme¹, Corinne Vandermeulen², Mathieu Roelants²

¹University of Antwerp, Centre For The Evaluation Of Vaccination, Vaccine & Infectious Diseases Institute, Antwerp, Belgium, ²KU Leuven, Department Of Public Health And Primary Care, Leuven, Belgium

Backgrounds: Only 10 of the 27 EU countries offer gender-neutral HPV-vaccination. In most of them, uptake is lower in boys than in girls. From the school year 2019-2020 onwards, the Flemish government offers gender-neutral free HPV-vaccination in the first year of secondary education, thereby including adolescent boys in its vaccination strategy. In 2021, a survey was performed using the WHO's EPI-method to assess (among others) adolescent HPV-vaccination coverage in Flanders, Belgium.

Methods: A total of 955 adolescents (°2007) were recruited in 103 municipalities through a two-stage randomized cluster design. After signing informed consent, a parent/caregiver of the adolescent was interviewed at home or through video call (pandemic-dependent). Available documents on vaccination history of the child were transcribed and later completed with information from the electronic Flemish vaccination registry and medical records. The coverage of recommended vaccines in childhood and adolescence was assessed, including HPV-vaccination in boys and girls.

Results: Overall, 854 adolescents received a first dose of the HPV vaccine (89.4%), and 771 received a second dose (80.7%). In girls, who have been offered HPV-vaccination since 2010, the coverage reached 92.3% and 84.3% for the first and second dose, respectively. Notably, 88.1% of boys in our cohort, who were the first to be offered HPV-vaccination, had received a first ($p=0.05$ vs. girls), and 78.4% a second dose ($p<0.001$ vs. girls).

Conclusions/Learning Points: The first year after the implementation of HPV-vaccination in boys already spurred an immense uptake. The coverage for the first dose is only marginally below that of girls but comparable to that when girls were first offered the vaccine (87.5%). The planning of the second dose coincided with the first COVID-19 lockdown, which could have impacted its coverage.

NEURODEVELOPMENTAL OUTCOMES OF YOUNG INFANTS FOLLOWING ENTEROVIRAL AND PARECHOVIRAL INFECTIONS OF THE CENTRAL NERVOUS SYSTEM

Oral Presentations Session

ORAL PRESENTATION SESSION 08: PUBLIC HEALTH & NON-RESPIRATORY INFECTIONS

María De Ceano-Vivas¹, M^a Luz García García², Ana Velázquez³, Fernando Martín Del Valle⁴, Ana Menasalvas⁵, Amaia Cilla⁶, Cristina Epalza⁷, M. Pilar Romero⁸, María Cabrerizo⁹, Cristina Calvo¹⁰
¹Hospital Universitario La Paz, Urgencias Pediátricas, Madrid, Spain, ²Hospital Universitario Severo Ochoa, Pediatrics, Madrid, Spain, ³La Paz University Hospital, Pediatric Department, Madrid, Spain, ⁴Severo Ochoa University Hospital, Pediatric Department, Madrid, Spain, ⁵Virgen de la Arrixaca University Hospital, Pediatric Department, Murcia, Spain, ⁶Burgos University Hospital, Pediatric Department, Burgos, Spain, ⁷HOSPITAL 12 DE OCTUBRE, Paediatrics, MADRID, Spain, ⁸La Paz University Hospital, Microbiology Department, Madrid, Spain, ⁹National Centre for Microbiology, Instituto de Salud Carlos III, Enterovirus And Viral Gastroenteritis Unit, Madrid, Spain, ¹⁰Hospital La Paz, Pediatric Infectious Diseases, Madrid, Spain

Backgrounds: Enteroviruses (EVs) and human parechoviruses (HPeVs) are a major cause of CNS infection in young infants. They have been implicated in neurodevelopmental delay, limited data are available. The aim of this study is to describe clinical outcome and to assess and compare medium-term neurodevelopment following EV and HPeV-CNS-infections.

Methods: A multicentre observational ambispective study was conducted between May-2013 and March-2018. Children under 3 months with EV or HPeV CNS-infection excluding encephalitis were included. Infants were contacted one year after acute infection. Their neurological development was evaluated using ASQ-3-test. If any area was abnormal during first round, a second round was completed later.

Results: Forty-eight young infants with EV and HPeV CNS infection were identified: 33 (68.8%) EV and 15 (31.3%) HPeV. At first assessment 14/29 (48.3%) EV and 3/15 (20%) HPeV positive cases presented some developmental concern in the ASQ-3-test. EV-positive infants showed mild and moderate alteration in all domains analysed and HPeV-positive infants showed mild alterations only in gross and fine motor domains. Significant alterations in communication were observed in EV-positive but not in HPeV-positive infants ($p=0.016$). At second assessment 4/13 (30.8%) EV-positive patients showed mild to moderate concerns in communication and gross motor function and 3/13 (23.1%) showed significant concern in fine motor function.

Conclusions/Learning Points: Although CNS infections without associated encephalitis are generally assumed to be benign our study shows that at a median age of 18 months, 48.3% of the EV-infected infants and 20% of HPeV-positive infants presented some developmental concern in the ASQ-3-test. We recommend monitor neurological development of infants during the first years of life after HPeV CNS infection and especially after EV CNS infection, even in mild cases, for an early intervention and stimulation if necessary.

O055 / #1110

GENOMIC SURVEILLANCE AND CLINICAL CHARACTERISTICS OF CHILDREN WITH GASTROENTERITIS PRODUCED BY SHIGA TOXIN-PRODUCING ESCHERICHIA COLI IN COSTA RICA

Oral Presentations Session

ORAL PRESENTATION SESSION 08: PUBLIC HEALTH & NON-RESPIRATORY INFECTIONS

Cristian Perez-Corrales¹, Valeria Peralta-Barquero¹, Francisco Duarte-Martinez², Gletty Oropeza-Barrios²

¹Caja Costarricense del Seguro Social, Hospital Nacional De Niños, Microbiology Lab, San Jose, Costa Rica, ²Instituto Costarricense de Investigación y Enseñanza en Nutrición y Salud, Lncrima, Cartago, Costa Rica

Backgrounds: Shiga-toxin producing *Escherichia coli* (STEC) can cause mild to bloody diarrhea and Hemolytic Uremic Syndrome (HUS). The expansion whole-genome sequencing (WGS) allows to determine characteristics such as sequence-type and phylogenetic relationship. The National Children's Hospital of Costa Rica is a tertiary referral hospital within the socialized medical care system. Here, we provide the results of the first genomic study of STEC in Costa Rica, based on a nationwide surveillance program.

Methods: Health records between 2015 and 2020 were reviewed for each patient using a standardized form to retrieve basic, demographic, microbiologic, molecular and clinical characteristics. All stool samples were analyzed by conventional culture techniques, automated antimicrobial susceptibility tests, end-point PCR and/or Filmarray GI Panel assays targeting STEC. WGS was performed using Illumina platform. Bioinformatic analyses were performed using BioNumerics v7.6.3 software, SPAdes and BLAST. *E. coli* functional genotyping plugin v1.2 was used for prediction of virulence factors, antimicrobial resistance and O/H predictions. A dendrogram was constructed using the categorical values similarity coefficient and the unweighted pair group method with arithmetic mean (UPGMA). Geographical versus phylogenetic information was visualized using TreeTom.

Results: 29 out of 3768 (0,8%) diarrheal disease studies found STEC as causative agent. The most common features were: age less than 3 years (n=22;76%), bloody diarrhea (n=19;65%), *ea*A gene (n=17;59%) *stx1* gene (n=22;76%), sequence type ST17 (n=9;31%), serotype O118/O151:H2 (n=7;24%). Hospitalization was required for 6 patients (20%) and 2 developed SUH (7%).

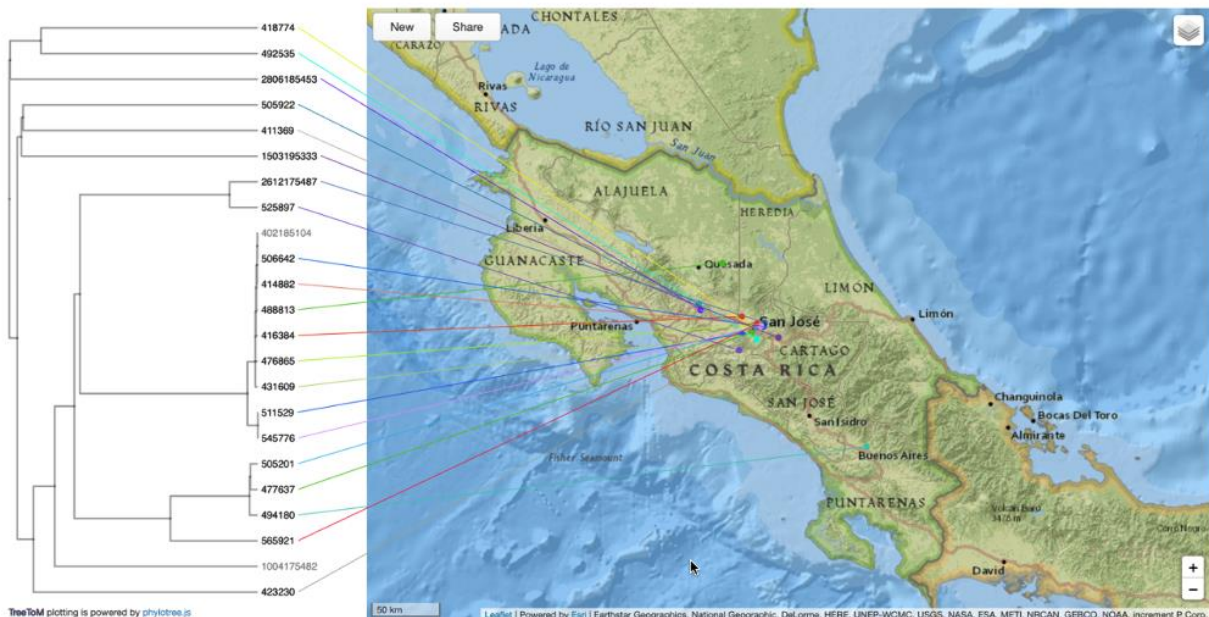

<https://camayal.info/wa/treetom/?id=8uxwz1pQgyJZbfEmg12t>

O056 / #1452

UNTARGETED METAGENOMIC SEQUENCING FOR INFECTIOUS DISEASE DIAGNOSIS WITH A FOCUS ON ENCEPHALITIS

Oral Presentations Session

ORAL PRESENTATION SESSION 08: PUBLIC HEALTH & NON-RESPIRATORY INFECTIONS

Sofia Morfopoulou¹, Julianne Brown², Nathaniel Storey², Divya Shah², Jack Lee², Kathryn Harris³, Judith Breuer⁴

¹Institute of Child Health, University College London, London, United Kingdom, ²Microbiology, Virology and Infection Prevention & Control, Great Ormond Street Hospital For Children, London, United Kingdom, ³Barts Health NHS Trust, Barts Health Nhs Trust, London, United Kingdom, ⁴UCL Great Ormond Street Institute for Child Health, Infection, Immunity And Inflammation Research Department, London, United Kingdom

Backgrounds: Clinically, metagenomics have been most useful in the context of diseases that have poor diagnoses rates. Encephalitis is a prime example, where even in richly-resourced settings, the causative agent remains elusive in the majority of the cases. Here we present the results from 7 years of clinical metagenomics studies performed at the Great Ormond Street Hospital for Children, with samples obtained from in-patients and patients from around the UK and Europe.

Methods: Untargeted metagenomic DNA and RNA sequencing was performed for brain biopsies (fresh, frozen and FFPE) and CSF samples. Negative and positive sequencing controls were included in each sequencing run from 2017 onwards. Sequencing data preprocessing consisted of bioinformatic removal of low quality, low complexity and human sequences. Protein and nucleotide based similarity search was followed by probabilistic taxonomic classification with metaMix to infer the microorganisms present in the sample.

Results: 82 clinical samples from encephalitis patients were sequenced, consisting of 65 brain biopsies (11 FFPE, 54 fresh or frozen) and 17 CSF samples. Pathogens were detected in 24 samples, with no pathogens found in 48 samples. RNA was degraded in 10 samples. Immune system status was recorded for 49 patients (60% immunocompromised). In this subset of patients, we detected the causative pathogen in 13 cases, all immunocompromised patients. Finally, 18 tissue specimens from patients with other suspected infections were sequenced, resulting in similar rates of pathogen and no pathogen detection (39% each outcome, 12% RNA degraded).

Conclusions/Learning Points: Metagenomics can play an important role in the management of hard to diagnose clinical syndromes, such as, but not limited to encephalitis. The effect is more striking in immunocompromised patients, as this is the patient population most at risk of infection with unexpected or novel microorganisms.

VALIDATION OF PEDIATRIC ORGAN DYSFUNCTION SCORES IN CHILDREN WITH BLOOD CULTURE-PROVEN INFECTION – A NATIONAL PROSPECTIVE COHORT STUDY

Oral Presentations Session

ORAL PRESENTATION SESSION 08: PUBLIC HEALTH & NON-RESPIRATORY INFECTIONS

Luregn Schlapbach^{1,2,3}, Sabrina Goertz¹, Niels Hagenbuch⁴, Blandine Aubert⁵, Sebastien Papis⁶, Eric Giannoni⁵, Klara Posfay-Barbe⁶, Martin Stocker⁷, Ulrich Heininger⁸, Sara Bernhard-Stirnermann⁹, Anita Niederer-Loher¹⁰, Christian Kahlert¹⁰, Giancarlo Natalucci¹¹, Christa Relly¹, Thomas Riedel¹², Christoph Aebi⁴, Christoph Berger¹, Philipp Agyeman⁴

¹University Children's Hospital Zurich, Pediatrics, Zurich, Switzerland, ²Child Health Research Centre, University of Queensland, Paediatric Critical Care Research Group, Brisbane, Australia, ³Queensland Children's Hospital, Children's Health Queensland, Paediatric Intensive Care Unit, Brisbane, Australia, ⁴Inselspital, Bern University Hospital, Pediatrics, Bern, Switzerland, ⁵Lausanne University Hospital and University of Lausanne, Department Mother-woman-child, Lausanne, Switzerland, ⁶University Hospitals of Geneva, Paediatrics, Geneva, Switzerland, ⁷Cantonal hospital Lucerne, Paediatrics, Lucerne, Switzerland, ⁸University Children's Hospital Basel, Infectious Diseases And Vaccinology, Basel, Switzerland, ⁹Cantonal Hospital Aarau, Paediatrics, Aarau, Switzerland, ¹⁰Children's Hospital of Eastern Switzerland, Paediatrics, St. Gallen, Switzerland, ¹¹University Hospital Zurich, Neonatology, Zurich, Switzerland, ¹²Cantonal Hospital Graubuenden, Pediatrics, Chur, Switzerland

Backgrounds: Previous studies applying Sepsis-3 criteria to pediatric sepsis were based on retrospective analyses of pediatric intensive care unit (PICU) cohorts. We aimed to validate organ dysfunction criteria in a population-based cohort of children with blood culture-proven infection, including emergency department, PICU, and ward patients.

Methods: National multi-center prospective cohort study of children <17 years with blood culture-proven sepsis between 1.9.2011 and 31.12.2015. We excluded preterm infants and neonates ≤ 7 days. We compared the 2005 International Pediatric Sepsis Consensus Conference (IPSCC), Pediatric Logistic Organ Dysfunction (PELOD)-2, pediatric Sequential Organ Failure Assessment (pSOFA), and Pediatric Organ Dysfunction Information Update Mandate (PODIUM) scores measured on day of blood culture sampling to predict 30-day mortality using area under the receiver-operating characteristic curves (AUC). Conditional random forest analyses and generalized linear mixed model prediction were used.

Results: We analyzed 877 sepsis episodes in 807 children, with a 30-day mortality of 4.3%. Presence of any organ dysfunction ranged from 32.7% (2005 IPSCC) to 55.3% (pSOFA). In adjusted analyses, the accuracy to predict mortality was highest for 2005 IPSCC (AUC 0.871, 95%CI: 0.819–0.924), followed by pSOFA (0.852; 95%CI: 0.784–0.92), PODIUM (0.852; 95%CI: 0.791–0.912), and PELOD-2 (0.827; 95%CI: 0.761–0.892). Neurologic, respiratory, and cardiovascular dysfunction were most predictive of 30-day mortality. Considering only these three organs adjusted AUC was 0.784 (0.70 - 0.868) for 2005 IPSCC and 0.771 (0.684-0.857) for PODIUM, while pSOFA (0.734; 0.641-0.828) and PELOD-2 (0.724; 0.627-0.822) had lower performances.

Conclusions/Learning Points: When comparing scores for organ dysfunction, 2005 IPSCC performed best, followed by pSOFA and PODIUM criteria. Although the accuracy between scores was comparable, we observed major differences in terms of classification of individual organ dysfunctions. Our findings confirm the importance of neurologic, respiratory, and cardiovascular dysfunction.

SNOTWATCH FEBRILE SEIZURES: WHEN DATA GO VIRAL

Oral Presentations Session

ORAL PRESENTATION SESSION 08: PUBLIC HEALTH & NON-RESPIRATORY INFECTIONS

Rana Sawires^{1,2}, Martin Kulldorff³, Michael Fahey^{4,5}, Hazel Clothier^{1,6}, Jim Buttery^{2,7,8,9,10}

¹Murdoch Children's Research Institute, Centre For Health Analytics, Parkville, Australia, ²Monash University, Faculty Of Medicine, Nursing And Health Sciences, Clayton, Australia, ³Harvard Medical School and Brigham and Women's Hospital, Department Of Medicine, Boston, United States of America, ⁴Monash Children's Hospital, Department Of Neurology, Clayton, Australia, ⁵Monash University, Neurogenetics Department, Clayton, Australia, ⁶University of Melbourne, School Of Population & Global Health, Parkville, Australia, ⁷University of Melbourne, Paediatrics, Melbourne, Australia, ⁸Royal Children's Hospital, Infectious Diseases/research, Melbourne, Australia, ⁹Murdoch Children's Research Institute, Centre For Health Analytics, Melbourne, Australia, ¹⁰Department of Health, Saefvic, Melbourne, Australia

Backgrounds: Febrile seizures are the most common cause of seizure in childhood. They occur in the presence of a fever (>38 degrees Celsius) in children aged between 6 months and 5 years. Viruses are well-described as the predominant causative agents and specific viruses have previously been implicated, including Human Herpesvirus-6 (HHV-6), Influenza A and B, Respiratory syncytial virus (RSV), Parainfluenza, Adenovirus, Rhinovirus and Enterovirus. Recent innovations in viral respiratory molecular diagnostics allow multiple viruses to be tested simultaneously using multiplex polymerase chain reaction (PCR). SNOTWATCH is a de-identified ecologic analysis platform capturing population level molecular diagnostic results together with hospital and primary care encounters. This project aims to utilise PCR data to understand the relationship between respiratory virus circulation and febrile seizures at a population level. We have created a novel statistical model for assessing these relationships in both time and space.

Methods: Our ecological study assessed relationships between presentations of febrile seizures and nine respiratory viruses detected at the largest hospital network in Melbourne, Australia, from 2010-2019. Associations were studied temporally and spatiotemporally through mixed-effects Poisson regression analysis, using monthly incidence of febrile seizures and positive PCR tests.

Results: Febrile seizure incidence peaked in June-September each year. Temporal analysis showed febrile seizures were significantly associated with Human metapneumovirus (1.19 RR), Influenza A (1.49 RR), Influenza B (1.33 RR) and RSV (1.52 RR) (Figure 1). Spatiotemporal analysis supported the association between febrile seizures and Influenza A, Influenza B and RSV (1.25, 1.12 and 1.20 RR respectively, $p < 0.0$)

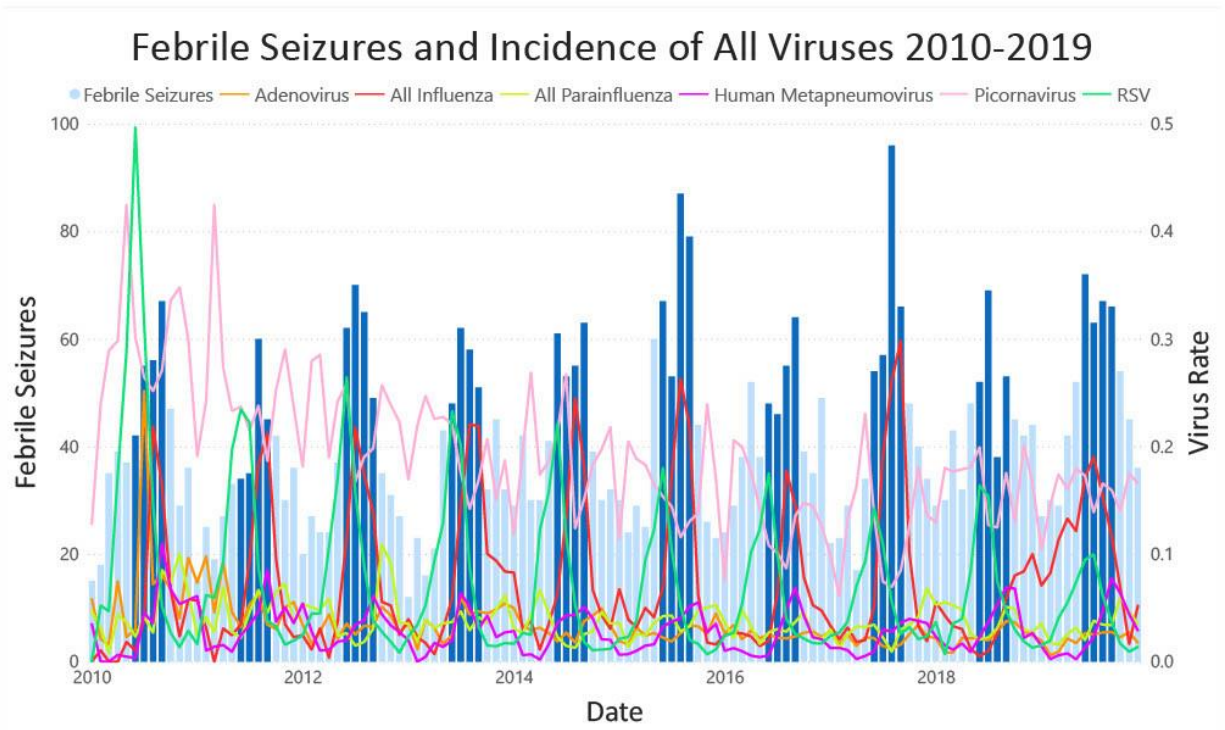

Conclusions/Learning Points: With over 90,000 PCR results and almost 5,000 febrile seizure presentations, our findings confirm the importance of understanding viral circulation patterns and their implications for paediatric health outcomes. Our statistical method may be used in predictive modelling to inform public health policy.

O059 / #1067

SEXUAL TRANSMITTED INFECTIONS IN ADOLESCENTS IN A TERTIARY HOSPITAL IN MADRID

Oral Presentations Session

ORAL PRESENTATION SESSION 08: PUBLIC HEALTH & NON-RESPIRATORY INFECTIONS

Arantxa Berzosa, Alba Ruedas, Marta Illán-Ramos, Paloma Merino, Carlos Elvira, Jose Tomas Ramos Amador
Clínico San Carlos Hospital, Paediatrics, Madrid, Spain

Backgrounds: Half of new sexual transmitted infections(STI) occur in adolescents, due to poor sexual education and less awareness of disease, leading to risk behaviours. Our aims were to describe the identified STI and estimate their incidence in patients younger than 18-years attended in our hospital over the last 7 years.

Methods: Retrospective descriptive study, including all STI diagnosed in our tertiary hospital in Madrid between 2015-2021. Two periods were compared: A(2015-2017) and B(2018-2021, excluding 2020 due to COVID-19-lockdown). Epidemiological-clinical data were collected from medical history. Microbiological tests were performed according to symptoms or medical history and they included: PCR for *N.gonorrhoeae*(NG) and *C.trachomatis*(CT) in urethral/urine samples, PCR for herpes-simplex-2(HSV-2) or human papillomavirus(HPV) in scraped samples and serological tests for HIV and syphilis.

Results: There were 58 STI diagnosed: 33 CT, 20 NG, 2 HSV-2, 2 syphilis(one HIV-infected) and 1 HPV, in 44 adolescents. Median age at diagnosis was 17.0years (IQR16.0-17.6); 25(56%) were female. There were 14 coinfections(CT-NG). CT was isolated more frequently in female(22 vs 11, p:0.02) while NG was in males(12 vs 8, p:0.03). One third of patients were asymptomatic and diagnosed after reporting sexual risk behaviour. All HSV-2 and HPV were tested due to consistent skin lesions. All infections were treated at the emergency room. Three girls required hospitalization due to pelvic inflammatory disease. The estimated incidence of STI in patients in period A was 0.51 per 1000-patients-years compared to 0.67 per 1000-patients-years in period B (p:0.36).

Conclusions/Learning Points: *C. trachomatis* and *N. gonorrhoeae* are the main STI diagnosed in adolescents in our setting, but other preventable severe STI occurred. Asymptomatic infections were common as well as co-infections. Paediatricians should be familiar to these infections, which may increase in the following years.

O060 / #981

IDENTIFICATION OF RARE CAUSAL GENETIC VARIANTS IN INVASIVE PNEUMOCOCCAL DISEASES BY EXOME ANALYSIS IN CHILDREN

Oral Presentations Session

ORAL PRESENTATION SESSION 08: PUBLIC HEALTH & NON-RESPIRATORY INFECTIONS

Morgane Gélín¹, Sophie Limou^{2,3}, Pierre-Antoine Gourraud^{2,4}, Axelle Durand², Olivia Rousseau², Christèle Gras-Leguen¹, Fleur Lorton¹, Julie Toubiana^{5,6}, Elise Launay¹, Nicolas Vince²

¹Nantes University Hospital, Paediatrics, Nantes, France, ²Nantes University, Crti, Nantes, France, ³Nantes University, Ecole Centrale De Nantes, Nantes, France, ⁴Nantes University Hospital, Clinique Des Données, Nantes, France, ⁵Necker Enfants malades Hospital, General Pediatrics And Pediatric Infectious Diseases, Paris, France, ⁶Institut Pasteur, Biodiversity And Epidemiology Of Bacterial Pathogens, Paris, France

Backgrounds: Invasive pneumococcal diseases (IPDs) are severe diseases in children. Host genetic factors are implicated in susceptibility and severity of IPDs. Further understanding of the molecular factors involved in the development of these severe infections could lead to better treatment, prevention, and thus better outcome. Previous studies identified several candidate genes for IPDs, however, mostly because of methodological shortcomings, these results are yet to be confirmed. Our study aimed to identify rare coding genetic variants implicated in the development of IPDs using whole-exome sequencing of 32 children admitted in pediatric intensive care unit for IPD.

Methods: Contrary to most previous studies related to IPDs, we chose an untargeted approach to find novel variants. We developed a bioinformatic analysis pipeline to identify rare, non-synonymous and possibly pathogenic variants implicated in IPDs. Furthermore, we compared the number of variants observed in our 32 patients to an unrelated control population (n=69) to validate our pipeline and discoveries.

Results: We identified 86 rare variants at heterozygous state in 18 different genes. The control population presented significantly fewer variants ($p=7.6 \times 10^{-16}$) in fewer genes ($p=5.5 \times 10^{-16}$). We could, with variants from 6 of these 18 genes, build a highly predictive model perfectly separating cases and controls.

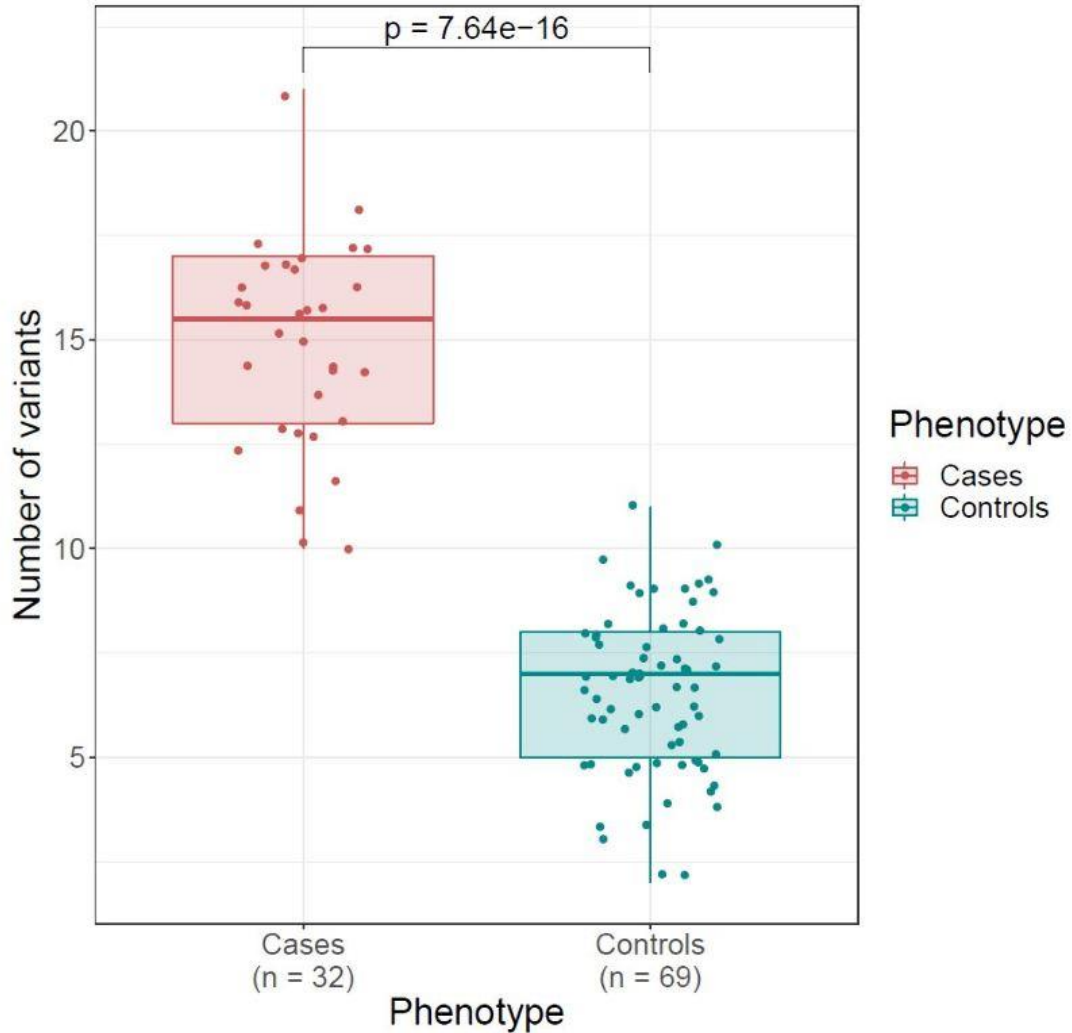

Conclusions/Learning Points: Our results revealed multiple heterozygous variants in a restricted set of genes for each patient presenting an extreme phenotype of pneumococcal disease, emphasizing the likely polygenicity of IPD risk. In conclusion, these first results suggest an unprecedented immune deficiency involving the association of several rare mutations in immune-related genes. These results may be used to predict the individual risk of children to present IPDs. We will pursue our efforts in characterizing this risk by reproducing our findings with other populations of children with IPDs.

O061 / #1211

CENTRAL-LINE ASSOCIATED BLOODSTREAM INFECTIONS IN CHILDREN WITH LONG-TERM PARENTERAL NUTRITION: A PROSPECTIVE COHORT STUDY

Oral Presentations Session

ORAL PRESENTATION SESSION 08: PUBLIC HEALTH & NON-RESPIRATORY INFECTIONS

Rita Nunziata, Fabrizia Chiatto, Alfonso Maria Farina, Sara Maria Scarano, Chiara Amato, Federica Pagano, Maria Immacolata Spagnuolo, Andrea Lo Vecchio
University of Naples, Federico II, Department Of Translational Medical Sciences - Section Of Pediatrics, Naples, Italy

Backgrounds: In children with intestinal failure on parenteral nutrition (PN), central-line associated bloodstream infections (CLABSI) are the most common complication. The aims of our study were to evaluate rates of CLABSI in children on long-term PN, to establish predisposing risk factors and the efficacy of taurolidine prophylaxis in reducing CLABSI incidence.

Methods: A 3-years prospective cohort study was performed at the Centre for Pediatrics Artificial Nutrition of University of Naples "Federico II". The primary outcome was the rate of CLABSI/1000 CL-days. Data of all children on PN in follow up were used to calculate the numerator and adjust infection rates.

Results: Eighteen children on PN were included in the study (13 male, median age of 91,5 months): 8 (45%) with short bowel syndrome, 6 (33%) with intestinal motility disorders, 4 (22%) with congenital enteropathies. Nine have a gastro/enterostomy. During the period of observation, 28 episodes of CLABSI were reported in 10 patients, 6 of which had more than one CLABSI, resulting in a CLABSI rate of 1.65/1000 CVC days [95%CI 1.13-2.38]. Coagulase Negative Staphylococci were the most isolated pathogens (59%). Four cases of S.Aureus-related CLABSI were successfully treated with antibiotics without CL removal. Gram-negative pathogens were only isolated in patients with enterostomy. The presence of a primary non-surgical enteropathy was associated with a recurrence of CLABSI ($p=0,007$). The rate of CLABSI was slightly reduced in children receiving taurolidine (1.51/1000 CL-days [95% CI 0.97-2.34]) compared to those receiving standard care (2.45 [95% CI 1.22-4.89]).

Conclusions/Learning Points: Infections are a major cause of morbidity in children undergoing PN. Primary gut diseases are associated with CLABSI incidence and recurrence. Larger study is needed to analyze the impact of taurolidine prophylaxis.

SAFETY OF COVID-19 VACCINATION IN CHILDREN WITH A HISTORY OF MIS-C: AN INTERNATIONAL SURVEY

Oral Presentations Session

ORAL PRESENTATION SESSION 09: COVID-19 VACCINES

Levi Hoste^{1,2}, Chiara Biazzo³, Antoni Soriano-Arandes⁴, Emilie Pauline Buddingh⁵, Elizabeth Whittaker⁶, Alexandre Belot⁷, Rolando Ulloa-Gutierrez⁸, Laura Olbrich⁹, Filomeen Haerynck^{1,2}

¹Ghent University, Primary Immune Deficiency Research Laboratory, Department Of Internal Diseases And Pediatrics, Centre For Primary Immunodeficiency Ghent, Jeffrey Modell Diagnosis And Research Centre, Ghent, Belgium, ²Ghent University Hospital, Department Of Internal Medicine And Pediatrics, Division Of Pediatric Pulmonology, Infectious Diseases And Inborn Errors Of Immunity, Ghent, Belgium, ³University of Bologna, Medicine And Surgery, Bologna, Italy, ⁴Hospital Universitari Vall d'Hebron (HUVH)., Pediatric Infectious Diseases And Immunodeficiencies Unit., Barcelona, Spain, ⁵Leiden University Hospital, Pediatrics, Leiden, Netherlands, ⁶Imperial Healthcare NHS Trust, Paediatric Infectious Diseases, London, United Kingdom, ⁷CHU Lyon, Pediatric Nephrology Rheumatology And Dermatology, Lyon, France, ⁸Hospital Nacional de Niños "Dr. Carlos Sáenz Herrera", Centro de Ciencias Médicas, Caja Costarricense de Seguro Social (C.C.S.S.), Servicio De Infectología Pediátrica, San José, Costa Rica, ⁹Hospital Universitario Virgen del Rocío, Instituto de Biomedicina de Sevilla, IBiS/ Universidad de Sevilla/CSIC, Red de Investigación Traslacional en Infectología Pediátrica RITIP, Pediatric Infectious Diseases, Rheumatology And Immunology Unit, Sevilla, Spain

Backgrounds: Multisystem inflammatory syndrome in children (MIS-C) is a rare but severe SARS-CoV-2 related disease occurring in children and adolescents. Its pathophysiology is incompletely unraveled, although superantigen-driven hyperinflammation is presumed. Currently approved pediatric vaccines against coronavirus disease 2019 (COVID-19) are mRNA-based and encode the SARS-CoV-2 spike protein. Theoretically, in children with previous MIS-C, re-exposure to the same viral protein could trigger hyperinflammation. However, to date, no specific safety data for COVID-19 vaccination are available for children with a history of MIS-C.

Methods: We conducted an international electronic questionnaire, running from 1 Nov 2021 to 15 Dec 2021.

Results: We collected data from 83 healthcare professionals involved with MIS-C, originating from 32 countries. Respondents provided information for 5673 MIS-C patients, of which 1750 (30.8%) were eligible for vaccination. Vaccination was documented in 273 (15.6%) children. For 420 additional cases, no contra-indication was in place and, therefore, respondents presumed vaccination without formal registration and vigilance of the procedure. MIS-C was declared as a contra-indication for COVID-19 vaccination in multiple regions (Belgium/France/Italy/India/Mexico/Pakistan/Turkey/USA), accounting for 1144 patients (20.2% of the cohort). Reasons for contra-indication included national/regional guidelines (9/14 regions) and safety concerns (9/14). In those vaccinated, mild/moderate adverse events (AE) were reported similarly to those published in healthy controls. Besides one patient experiencing Bell's palsy, no severe/serious AE were described. In particular, no relapse MIS-C or other similar inflammatory conditions were reported.

Conclusions/Learning Points: MIS-C is not regarded as a universal contra-indication for COVID-19 vaccination in most countries. In those vaccinated, no particular AE and no relapse MIS-C was reported. At the time of the survey, less than one-third of MIS-C patients were eligible for vaccination and at most 40 percent of those eligible were vaccinated. Further follow-up is warranted.

O063 / #1179

TOTAL AND NEUTRALIZING SARS-COV-2 SPIKE ANTIBODIES ONE, FOUR AND EIGHT MONTHS AFTER BNT162B2 IMMUNIZATION IN HEALTHCARE WORKERS FROM A MAJOR TERTIARY PEDIATRIC HOSPITAL

Oral Presentations Session

ORAL PRESENTATION SESSION 09: COVID-19 VACCINES

Athanasios Michos¹, Elizabeth- Barbara Tatsi², [Filippos Filippatos](#)¹, Charilaos Dellis¹, Vasiliki Efthymiou², Vassiliki Syriopoulou¹

¹National and Kapodistrian University of Athens, First Department Of Pediatrics, Infectious Diseases And Chemotherapy Research Laboratory, 'Aghia Sophia' Children's Hospital, Athens, Greece, Athens, Greece, ²National and Kapodistrian University of Athens, University Research Institute For Maternal And Child Health And Precision Medicine, Athens, Greece, Athens, Greece

Backgrounds: Long-term data regarding the association of antibody levels after immunization with the BNT162b2 mRNA COVID-19 vaccine with epidemiological and clinical parameters are limited. We prospectively measured the total(TAbs) and neutralizing antibodies(NAbs) against the receptor binding domain(RBD) of SARS-CoV-2 spike protein in healthcare workers(HCWs) 1, 4 and 8 months after the 2nd dose of the BNT162b2 vaccine.

Methods: Serum samples from 462 HCWs of "Aghia Sophia" Children's Hospital, Greece were collected and tested for TAbs-RBD using the Elecsys® Anti-SARS-CoV-2 S reagent and for NAbs-RBD using the Food and Drug Administration (FDA) approved blocking ELISA cPass™ SARS-CoV-2 neutralization antibody detection kit. A statistical analysis for possible association of antibodies' levels with epidemiological and clinical parameters was performed.

Results: The mean age (\pm SD) of the participants was 48.33 years (\pm 12.98) and 361(77.1%) were females. No significant differences in TAbs-RBD and NAbs-RBD were detected regarding gender and history of autoimmune diseases. A statistically significant negative association of NAbs-RBD was detected for age (β =-0.046, P <0.001). Smokers had significantly lower TAbs-RBD and NAbs-RBD (P <0.05) than non-smokers in each time-point of the study. TAbs-RBD in HCWs with underlying diseases significantly declined in all time points (P =0.005). HCWs with allergies showed higher TAbs-RBD in 1 and 4 months after the 2nd dose (P =0.003 and P =0.008 respectively). HCWs with AB blood type had lower TAbs-RBD than the other blood types in all time-points (P =0.044), especially 4 months after the 2nd dose (P =0.014).

Conclusions/Learning Points: A significant gradual decline in TAbs and NAbs was detected within the first 8 months after the 2nd dose. Our findings support that older age and smoking negatively affect antibody levels, thus the administration of a booster dose in those groups is highly recommended.

HIGH SAFETY AND ACCEPTANCE OF COVID-19 VACCINES IN ADOLESCENTS AFTER MULTISYSTEM INFLAMMATORY SYNDROME IN CHILDREN (MIS-C)

Oral Presentations Session

ORAL PRESENTATION SESSION 09: COVID-19 VACCINES

Cristina Epalza¹, Luis Prieto¹, Rosa Pino², Paula Escartin-Paredes¹, Inés Leoz³, Carlos Grasa⁴, Ana Vivanco-Allende⁵, Jaques G. Rivière⁶, Jaime Carrasco⁷, Olatz Villate⁸, Victoria Fumadó Pérez⁹, Concepción Hermoso-Ibañez¹, Blanca Herrero³, David Aguilera-Alonso¹⁰, Alfredo Tagarro¹¹, Cinta Moraleda¹², Working Group Epico-Aep¹³

¹Hospital 12 Octubre, Pediatrics, Madrid, Spain, ²Sant Joan de Deu, Pediatrician, Esplugues de Llobregat, Spain, ³Hospital Universitario Niño Jesús, Pediatrics, Madrid, Spain, ⁴La Paz University Hospital, Pediatrics And Infectious Diseases, Madrid, Spain, ⁵Hospital Universitario Central de Asturias, Pediatrics, Oviedo, Spain, ⁶Hospital Universitari Vall d'Hebron (HUVH), Pediatric Infectious Diseases And Immunodeficiencies Unit, Barcelona, Spain, ⁷HOSPITAL SON ESPASES, Paediatrics, PALMA DE MALLORCA, Spain, ⁸Hospital de Cruces, Pediatrics, Barakaldo, Spain, ⁹Hospital Universitari Sant Joan de Déu, Infectious Diseases Department, Barcelona, Spain, ¹⁰Hospital Gregorio Marañón, Paediatric Infectious Diseases Unir, Madrid, Spain, ¹¹Hospital Universitario Infanta Sofía, Paediatrics, San Sebastián de los Reyes, Spain, ¹²HOSPITAL 12 DE OCTUBRE, Paediatrics, MADRID, Spain, ¹³Fundación Investigación Biomédica, Hospital 12 Octubre, Madrid, Spain

Backgrounds: Multisystem inflammatory syndrome in children (MIS-C) is a condition characterized by a dysregulated response of the immune system 2-6 weeks after a SARS-CoV-2 infection. Some authors hypothesized that the COVID-19 vaccine could trigger a new exaggerated response in these children. Our aim was to assess the proportion of vaccinated children and the incidence of new MIS-C or myocarditis after vaccination in adolescents with previous MIS-C.

Methods: From the Epidemiological Study of COVID-19 in Children of the Spanish Pediatric Association, we contacted researchers from centers with ≥ 3 MIS-C patients aged 12-18 years old by October 31, 2021, hospitalized from March 2020, through October 2021 and fulfilling WHO criteria for MIS-C. We performed a semi-structured telephonic interview with the caregivers and/or the adolescents, about vaccination acceptance and adverse events after vaccination.

Results: An interview was possible in 42/48 (87.5%) selected adolescents, being mainly male (30/42, 71.4%) and, at MIS-C diagnosis, their median age was 13.1 years old. 32/42 (76.2%) patients had received COVID-19 vaccine. The median time between MIS-C diagnosis and vaccination was 42 weeks and the telephonic interview took place after a median of 10.0 weeks (range 5.3-19.7) post-vaccination. After vaccination, 22/32 (68.8%) patients reported adverse events, being 86.7% mild and 3.3% moderate (Table1). No new MIS-C or myocarditis or pericarditis episodes were reported.

Conclusions/Learning Points: In this study, we describe a high acceptance and low incidence of relevant adverse events after COVID-19 vaccines in a population of adolescents with a previous MIS-C diagnosis. No new MIS-C episodes or myocarditis occurred after a median of 10 weeks post-vaccination. The results of this study are reassuring and may help to decide for patients with previous MIS-C who are

considering COVID-19 vaccination.

Table 1. Comparison of patients and MIS-C episodes according to vaccination status. Information about vaccination in the total population is not included because it is the same as for the vaccinated population.

| | Total (n=42) | Vaccinated (n=32) | Unvaccinated (n=10) | p-value |
|--|------------------|----------------------|------------------------|---------|
| Gender male n(%) | 30 (71.4) | 23 (71.9) | 7 (70.0) | 1.000 |
| Characteristics of MIS-C episode | | | | |
| Age at MIS-C episode, median (Q1-Q3) | 13.1 (12.6-15.1) | 13.2 (12.6-15.2) | 12.9 (12.7-14.4) | 0.595 |
| Admission duration (days) median (Q1-Q3) | 10.0 (8.0-12.0) | 10.5 (8.0-13.0) | 9.5 (7.0-11.0) | 0.288 |
| PICU admission n(%) | 32 (76.2) | 24 (75.0) | 8 (80.0) | 1.000 |
| PICU admission duration (days) median (Q1-Q3) | 5.0 (4.0-8.5) | 6.0 (4.0-10.0) | 4.0 (3.0-5.5) | 0.082 |
| Oxygen therapy n(%) | 25 (59.5) | 22 (68.8) | 3 (30.0) | 0.062 |
| Mechanical ventilation n(%) | 10 (23.8) | 9 (28.1) | 1 (10.0) | 0.404 |
| Inotropes n(%) | 26 (61.9) | 20 (62.5) | 6 (60.0) | 1.000 |
| Cardiological complications n(%) | 33 (78.6) | 25 (78.1) | 8 (80.0) | 1.000 |
| Myocarditis/myocardial dysfunction n(%) | 32 (76.2) | 24 (75.0) | 8 (80.0) | 1.000 |
| Coronary abnormalities n(%) | 3 (7.1) | 2 (6.2) | 1 (10.0) | 1.000 |
| Coronary aneurysm n(%) | 0 | 0 | 0 | - |
| Information related to COVID-19 vaccination | | | | |
| Hesitancy about vaccination n(%) | 8 (19.0) | 6 (18.8) | 2 (20.0) | 1.000 |
| Sought medical advice before vaccination n(%) | 7 (16.7) | 6 (18.8) | 1 (10.0) | 1.000 |
| Time between MIS-C and vaccination (weeks) median (Q1-Q3) | - | 42.0 (27.4-68.1) | - | - |
| Time between vaccination and survey (weeks) median [range] | - | 10.0 (5.3-19.7) | - | - |
| Vaccine type n(%) | | | | |
| Cominarty (Pfizer-BioNTech™) | - | 28 (87.5) | - | - |
| Spikevax (Moderna™) | - | 4 (12.5) | - | - |
| Patients reporting adverse events after vaccination n(%) | - | 22 (68.8) | - | - |
| Type of adverse event n(%) | | | | |
| Local reaction in injection site | - | 14 (43.8) | - | - |
| Fatigue | - | 11 (34.4) | - | - |
| Fever | - | 4 (12.5) | - | - |
| Headache | - | 1 (3.1) | - | - |
| Severity of adverse events n(%) | | | | |
| Mild (no interference with daily activities) | - | 26 (86.7) | - | - |
| Moderate (partial limitation of daily activities) | - | 4 (13.3) | - | - |
| Severe (hospitalization or prevents daily activities) | - | 0 | - | - |
| Duration of the adverse events, (days) median (Q1-Q3) | - | 1 (1-2) | - | - |
| Sought medical assistance for side effects n(%) | - | 1 (3.1) | - | - |

MIS-C: multisystemic inflammatory syndrome in children; PICU: pediatric intensive care unit; Q1: 1st quartile; Q3: 3rd quartile.

O065 / #1208

SHORT-TERM IMMUNOGENICITY TO MRNA SARS-COV-2 VACCINES IN HIV-INFECTED ADOLESCENTS

Oral Presentations Session

ORAL PRESENTATION SESSION 09: COVID-19 VACCINES

Arantxa Berzosa¹, Alba Ruedas¹, Marta Illán-Ramos², Maria Luisa Navarro³, Luis Prieto⁴, Cristina Epalza⁵, Sara Guillén⁶, Ana Belen Jimenez⁷, Santiago Jimenez De Ory³, Rafael Sanchez⁸, Kauzar Mohamed⁹, A De La Peña¹, Silvia Sanchez-Ramon⁹, Jose Tomas Ramos Amador¹
¹Clínico San Carlos Hospital, Paediatrics, Madrid, Spain, ²Hospital Universitario Clínico San Carlos, Department Of Pediatrics, Madrid, Spain, ³Hospital Gregorio Marañón, Pediatrics, MADRID, Spain, ⁴HOSPITAL 12 DE OCTUBRE, Paediatrics, MADRID, Spain, ⁵Hospital 12 Octubre, Pediatrics, Madrid, Spain, ⁶Hospital Getafe, Pediatrics, Madrid, Spain, ⁷Fundación Jimenez Díaz, Pediatrics, MADRID, Spain, ⁸Clínico San Carlos Hospital, Statistics, Madrid, Spain, ⁹Clínico San Carlos Hospital, Immunology, Madrid, Spain

Backgrounds: There is a need to assess the immunogenicity and duration of immune response to SARS-CoV-2 mRNA vaccination in HIV-infected patients. Scarce data exist on HIV-infected adolescents.

Methods: A prospective ongoing observational study is being conducted in HIV-infected patients > 12 years of age after the introduction of mRNA vaccination in Spain. Blood samples were drawn 3-10 weeks after the first or second dose (according to prior SARS-CoV2 infection) of BNT162b2 (Pfizer/BioNTech) and CoV-2-mRNA-1273 (Moderna) vaccines in 20 HIV-infected adolescents and compared to 20 matched healthy-control subjects. Humoral response was assessed by detection of SARS-CoV-2 antibodies by chemiluminescent-microparticle-immunoassay (CMIA) (Alinity® Quant assay-Abbott) to detect IgG against S1-region of the spike-protein of SARS-CoV-2 (≥ 50 U/mL considered reactive). T-Cell response to SARS-CoV-2 was measured by an interferon-gamma-released-assay (IGRA, Euroimmun) of S1 peptide-stimulated T-cells in whole blood (≥ 200 mlU/ml considered reactive).

Results: Blood samples from 20 HIV-infected adolescents were drawn after vaccination (15 Pfizer/BioNTech, 5 Moderna), see figure one. Mean age was 16.7 ± 3.9 and 14.3 ± 3.9 years in patients and controls, respectively ($p:0.06$). Mean intervals since last vaccine dose in HIV-infected and controls were 44.0 ± 15.1 and 38.5 ± 12.6 days, ($p > 0.05$). Two HIV-infected patients and 6 controls had documented past SARS-CoV-2 infection. All patients and controls had reactive humoral and cellular responses. HIV-infected subjects had lower anti-Spike antibodies titers (mean 14251 ± 8270 U/mL) than controls (mean 27716 ± 15768 U/mL) ($p:0.013$). Likewise, cellular immune responses were lower in HIV-infected adolescents (mean 1609 ± 418 mlU/ml) than in controls (mean 1777 ± 356 mlU/ml), ($p:0.024$).

Figure 1. HIV patients characteristics

| | | |
|--------------------------------|--|--------------------|
| Epidemiological | | |
| Female | | 13 (65%) |
| Perinatally infected | | 19 (95%) |
| Origin | | |
| Caucasian | | 11 (55%) |
| Latino | | 3 (15%) |
| African | | 6 (30%) |
| Clinical | | |
| C or 3 CDC classification | | 8 (40%) |
| Immunovirological situation | | |
| Nadir CD4, absolute* | | 423+/-269 cells/ul |
| Nadir CD4, percentage* | | 19.3+/-10.2 |
| Baseline CD4, absolute * | | 789+/-299 cells/ul |
| Baseline CD4, percentage * | | 35.2+/-5.5 |
| Plasma HIV-RNA <30 copies/ml | | 18(90%) |
| Treatment | | |
| Integrase inhibitors-based ART | | 19 (95%) |

*Mean, SD

Conclusions/Learning Points: Perinatally HIV-infected adolescents with good immunologic and virological status elicit appropriate specific antispikes-antibody levels and cellular immune responses against SARS-CoV-2 shortly after mRNA vaccination, but of lower amount than healthy control subjects. More prolonged studies are underway to determine the evolution of humoral and cellular immune responses after vaccination.

O066 / #1304

PERINATALLY HIV-INFECTED ADOLESCENTS AND YOUNG ADULTS DEMONSTRATE DISTINCT BNT162B2 MRNA COVID-19 VACCINE IMMUNOGENICITY

Oral Presentations Session

ORAL PRESENTATION SESSION 09: COVID-19 VACCINES

Elena Morrocchi¹, Chiara Pighi¹, Giuseppe Rubens Pascucci¹, Nicola Cotugno¹, Chiara Medri¹, Donato Amodio², Luna Colagrossi¹, Alessandra Ruggiero³, Emma Manno², Chiara Tumeo³, Stefania Bernardi⁴, Kinga Smolen⁵, Carlo Perno⁶, Al Ozonoff⁵, Paolo Rossi⁷, Ofer Levy⁵, Paolo Palma¹

¹Bambino Gesù Children Hospital, Clinical Immunology And Vaccinology Research Unit, Rome, Italy, ²Bambino Gesù Children Hospital, Clinical Immunology And Vaccinology, Rome, Italy, ³Bambino Gesù Children Hospital, Clinical Immunology And Vaccinology Research Unit, ROMA, Italy, ⁴Bambino Gesù Children's Hospital, IRCCS, Immunology An Infectious Diseases Unit, Rome, Italy, ⁵Boston Children's Hospital, Infectious Diseases, Boston, United States of America, ⁶Bambino Gesù Children's Hospital, Department Of Microbiology, ROMA, Italy, ⁷Bambino Gesù Children's Hospital, IRCCS, Academic Department Of Paediatrics, Rome, Italy

Backgrounds: Immunization of vulnerable populations with distinct immunity often results in suboptimal immunogenicity, durability and efficacy.

Methods: To investigate the safety and the immunogenicity profiles of BNT162b2 mRNA COVID-19 vaccine among people living with HIV, we enrolled 28 HIV-infected patients under ART and 65 healthy controls (HCs) with no previous history of COVID-19. Immunogenicity was evaluated by measuring anti-RBD and anti-trimeric Abs, along with the frequency of SARS-CoV-2 specific CD4+CD40L+T cells. Samples were collected before vaccination (baseline, D0), at the second dose (D21), at 4 weeks (D28) and 6 months (D180) after the first dose. T and B cell phenotypes were investigated. Proteomic profiles at D0 and D28 were assessed with a Proximity Extension Assay (Olink) on plasma samples.

Results: All vaccinated HIV-infected patients mounted anti-SARS-CoV-2 humoral responses between D21 and D28 similarly to HCs, albeit lower titers of anti-trimeric S Abs were detected at D28 compared to HC ($p=0.0098$). Only PBMCs of HIV+ demonstrated at D28 an impaired ability to expand their specific (CD40L+) CD4+ T populations. At 6 months, follow-up HIV+ showed similar maintenance of anti-SARS-CoV-2 Abs to HC. To explore whether these immunogenicity results could be linked to a particular proteomic outline, we correlated baseline protein levels to either humoral or cellular responses, identifying clusters of molecules involved in immune response regulation with inverse profiles between the two study groups.

Conclusions/Learning Points: Responses of ART-treated HIV+ compared to HC, characterized by distinct features especially within the proteomic compartment, supporting their eligibility to an additional dose scheduled at 6 months, similarly to HC.

COVID-19 VACCINATION DURING PREGNANCY AND RISK OF PRETERM BIRTH, SMALL-FOR-GESTATIONAL-AGE BIRTH, AND STILLBIRTH IN ONTARIO, CANADA

Oral Presentations Session

ORAL PRESENTATION SESSION 09: COVID-19 VACCINES

Deshayne Fell¹, Sheryll Dimanlig-Cruz², Annette Regan³, Siri Haberg⁴, Christopher Gravel⁵, Laura Oakley⁶, Gillian Alton², Tavleen Dhinsa², Eszter Török², Prakesh Shah⁷, Darine El-Chaâr⁸, Mark Walker⁸, Jon Barrett⁹, Ann Sprague², Nannette Okun¹⁰, Sarah Buchan¹¹, Jeffrey Kwong¹¹, Sarah Wilson¹¹, Sandra Dunn², Kumanan Wilson¹², Shannon Macdonald¹³, Shelley Dougan²

¹UNIVERSITY OF OTTAWA AND CHILDREN'S HOSPITAL OF EASTERN ONTARIO RESEARCH INSTITUTE, School Of Epidemiology And Public Health, Ottawa, Canada, ²BORN Ontario, Born Ontario, Ottawa, Canada, ³University of San Francisco, School Of Nursing And Health Professions, San Francisco, United States of America, ⁴Norwegian Institute of Public Health, Norwegian Institute Of Public Health, Oslo, Norway, ⁵University of Ottawa, School Of Epidemiology And Public Health, Ottawa, Canada, ⁶London School of Hygiene and Tropical Medicine, Epidemiology, London, United Kingdom, ⁷Mt Sinai Hospital, Neonatology, Toronto, Canada, ⁸University of Ottawa, Obstetrics And Gynecology, Ottawa, Canada, ⁹McMaster University, Obstetrics And Gynecology, Hamilton, Canada, ¹⁰Sunnybrook Health Sciences Centre, Obstetrics And Gynecology, Toronto, Canada, ¹¹ICES and University of Toronto, Dalla Lana School Of Public Health, Toronto, Canada, ¹²University of Ottawa, Internal Medicine, Ottawa, Canada, ¹³University of Alberta, School Of Nursing, Edmonton, Canada

Backgrounds: Emerging evidence suggests COVID-19 vaccination during pregnancy may reduce risk of newborn SARS-CoV-2 infection; however, safety concerns remain a potential obstacle to achieving high coverage during pregnancy. This study aimed to assess the risk of preterm birth, small-for-gestational-age (SGA) birth, and stillbirth after COVID-19 vaccination during pregnancy.

Methods:: We used provincial databases in Ontario, Canada to identify all live and stillbirths ≥ 20 weeks' gestation (birth registry), linked to COVID-19 vaccination data (vaccine registry) for May 1 to November 30, 2021. Using Cox regression, we estimated adjusted hazard ratios (aHR) and 95% confidence intervals (CI) for preterm birth, SGA birth ($< 10^{\text{th}}$ percentile), and stillbirth treating COVID-19 vaccination as a time-varying exposure. Models were adjusted for calendar time, COVID-19 illness, sociodemographic factors, health behaviours, and pregnancy-related factors.

Results: Among 69,650 births, 33,295 (47.8%) were born to individuals who received ≥ 1 dose of COVID-19 vaccine during pregnancy. The incidence of preterm birth was 6.5% among those who received ≥ 1 dose of COVID-19 vaccine during pregnancy and 7.0% among unvaccinated. The risk of preterm birth was not associated with COVID-19 vaccination during pregnancy (adjusted HR [aHR] 0.96, 95% CI, 0.91 to 1.02), nor was spontaneous preterm birth or very preterm birth (< 32 weeks). Similarly, there was no increased risk of SGA birth in vaccinated vs. unvaccinated individuals (8.7% vs. 9.2%; aHR, 1.00; 95% CI, 0.95 to 1.05) or stillbirth (1.6 vs. 2.8 per 1000; aHR, 0.64; 95% CI, 0.46 to 0.90). Results did not differ by trimester of vaccination, mRNA vaccine product, or number of doses received during pregnancy.

Conclusions/Learning Points: In this large population, COVID-19 vaccination during pregnancy was not associated with a higher risk of preterm birth, SGA birth, or stillbirth.

SAFETY AND IMMUNOGENICITY OF CHADOX1 NCOV-19 (AZD1222) VACCINE IN CHILDREN AGED 6-17 YEARS: A PRELIMINARY REPORT OF A RANDOMISED CONTROLLED TRIAL

Oral Presentations Session

ORAL PRESENTATION SESSION 09: COVID-19 VACCINES

Natalie Marchevsky¹, Grace Li¹, Federica Cappuccini², Parvinder. K Aley¹, Robert Aley¹, Rachel Anslow¹, Sagida Bibi¹, Katrina Cathie^{3,4}, Elizabeth. A Clutterback¹, Rachel Cooper¹, Saul Faust^{3,4}, Shuo Feng¹, Paul Heath⁵, Simon Kerridge¹, Alice Lelliott¹, Yama. F Mujadidi¹, Khuen. F Ng⁶, Sarah Rhead¹, Hannah Roberts¹, Hannah Robinson¹, Marion. R Roderick⁶, Nisha Singh¹, David Smith¹, Matthew. D Snape¹, Rinn Song¹, Karly Tang¹, Andy Yao¹, Xinxue Liu¹, Teresa Lambe^{1,7}, Andrew. J Pollard^{1,8}

¹University of Oxford, Oxford Vaccine Group, Department Of Paediatrics, Oxford, United Kingdom, ²University of Oxford, Jenner Institute, Oxford, United Kingdom, ³University of Southampton, Faculty Of Medicine And Institute For Life Sciences, Southampton, United Kingdom, ⁴University Hospital Southampton NHS Trust, NihR Southampton Clinical Research Facility And Biomedical Research Centre, Southampton, United Kingdom, ⁵St George's, University of London & St George's University Hospitals NHS Trust, Vaccine Institute, London, United Kingdom, ⁶University of Bristol, Bristol Royal Hospital For Children, Bristol, United Kingdom, ⁷University of Oxford, Chinese Academy Of Medical Science (cams) Oxford Institute (coi), Oxford, United Kingdom, ⁸NIHR, Oxford Biomedical Research Centre, Oxford, United Kingdom

Backgrounds: Few data are published on immune responses against SARS-CoV-2 induced by COVID-19 vaccines in people under the age of 18 years compared with adults.

Methods: COV006 is a phase 1/2, single-blind, randomised controlled trial of ChAdOx1 nCoV-19 (ChAd) in children and adolescents aged 6-17 years in the UK. Participants were randomised 4:1:4:1 to receive two doses of ChAd or control (capsular group B meningococcal) vaccine (4:1), 28 days (short-interval) or 84 days (long-interval) apart. The primary outcome was safety and tolerability, with immunogenicity in the baseline-seronegative participants as the secondary outcome. Due to the restrictions in the use of ChAd introduced during the study, only participants aged 12-17 years randomised to the short-interval were vaccinated as planned (D28). The remaining participants received their second dose at D112.

Results: Of 262 participants, 211 and 51 were randomised to the ChAd and control arms, respectively. No serious adverse events related to ChAd administration were recorded. Solicited adverse reactions were reported more frequently after the first dose compared with the second dose, across all age and interval groups. In participants aged 12-17 years, anti-SARS-CoV-2 IgG and pseudoneutralising antibody titres at D28 post-second dose were higher in the long-interval arm (geometric mean ratios (GMR): 1.70, 95%CI: 1.27-2.26 and 1.99, 95%CI: 1.39-2.86, respectively) than after a short-interval. Humoral responses were higher in participants aged 6-11 years than those aged 12-17 years (GMR: 1.48, 95%CI: 1.07-2.07 and 2.96, 95%CI: 1.89-4.62 for anti-SARS-CoV-2 IgG and pseudoneutralising antibody titres, respectively). Cellular responses peaked after a first dose of ChAd across all age and interval groups.

Conclusions/Learning Points: ChAdOx1 nCoV-19 is well-tolerated and immunogenic in children aged 6-17 years. No safety concerns were raised in this trial.

O069 / #724

SYSTEMATIC REVIEW OF HOST GENOMIC BIOMARKERS OF INVASIVE BACTERIAL DISEASE: DISTINGUISHING BACTERIAL FROM NON-BACTERIAL CAUSES OF ACUTE FEBRILE ILLNESS.

Oral Presentations Session

ORAL PRESENTATION SESSION 10: BIOMARKERS & DIAGNOSTICS

Eimear Kelly¹, Sean Whelan², Sarah Murphy³, Andrew Pollard⁴, Daniel O' Connor¹

¹Oxford Vaccine Group, Department of Paediatrics, University of Oxford, Oxford, UK., Department Of Paediatrics, Oxford, United Kingdom, ²GUH, Dept Of Clinical Microbiology, Galway, Ireland, ³Cork University Maternity Hospital, Cork, Department Of Neonatology, Cork, Ireland, ⁴University of Oxford, Paediatrics, Oxford, United Kingdom

Backgrounds: Infectious diseases play a significant role in the global burden of disease. The gold standard for the diagnosis of bacterial infection, culture of bacteria, can lead to diagnostic delays and unnecessary antibiotic use. The advent of high-throughput microarray and sequencing has led to the discovery of host-based genomic biomarkers, capable of differentiating bacterial from other causes of infection but few have achieved validation for use in a clinical setting.

Methods: A systematic review was performed. PubMed/Ovid Medline, Ovid Embase and Scopus databases were searched for relevant studies from inception up to 21/09/2020 with forward and backward citation searching of key references. Studies which compared the diagnostic performance of host genomic biomarkers of bacterial infection to those with non-bacterial sources of infection were included. Study selection and assessment of quality was conducted by two independent reviewers. Meta-analysis was undertaken for all included genomic signatures using a diagnostic random-effects model. The review was registered with PROSPERO (ID: CRD42021208462).

Results: Sixty-eight studies which evaluated the performance of 110 biomarkers in 15,299 patients were included. Forty-seven studies examined the performance of biomarkers specific to TB infection and twenty studies were conducted in a paediatric population. The results of pooled sensitivity, specificity, negative and positive likelihood ratio and diagnostic odds ratio of genomic biomarkers of bacterial infection were 0.81 (95% CI 0.78 to 0.83), 0.86 (95% CI 0.84 to 0.88), 0.18 (95% CI 0.15 to 0.21), 5.7 (95% CI 5.0 to 6.5), 31.3 (95% CI 25 to 39), respectively. Significant heterogeneity (I² 77%) was present.

Conclusions/Learning Points: Host derived genomic biomarkers show significant potential for clinical use as diagnostic tests of bacterial infection however, further validation and attention to test platform is warranted before clinical implementation can be achieved.

O070 / #1425

A NOVEL AND POWER-FREE SAMPLE PREPARATION METHOD TO ALLOW RAPID DETECTION OF SARS-COV-2 RNA FROM NASOPHARYNGEAL SAMPLES

Oral Presentations Session

ORAL PRESENTATION SESSION 10: BIOMARKERS & DIAGNOSTICS

Ivana Pennisi¹, Matthew Cavuto², Myrsini Kaforou³, Michael Levin³, Pantelis Georgiou², Jesus Rodriguez-Manzano³

¹Imperial College, Infectious Disease, London, Italy, ²Imperial College, Electric And Electronic Engineering, London, United Kingdom, ³Imperial College London, Department Of Infectious Disease, London, United Kingdom

Backgrounds: The ongoing COVID-19 pandemic has led to over five million deaths worldwide highlighting an unprecedented need for rapid diagnostic screening. The gold standard for COVID-19 diagnosis is the collection of a nasopharyngeal swab subsequently processed with an RNA extraction kit requiring electricity and expensive laboratory equipment. Therefore, the diagnosis of COVID-19 in low- and middle-income countries (LMIC) is rarely achievable at a point-of-care (POC) and instead relegated to remote centralized laboratories. To address this need, our team has developed an innovative, rapid and easy to use sample preparation method for RNA extraction allowing for true POC application.

Methods: The SmartLid™ extraction method utilizes a custom 3D printed magnetic lid, designed to work with standard Eppendorf tubes, to transfer magnetic nanoparticles and attached RNA through three sample preparation steps. This is in contrast to all other manual extraction methods, which require expensive micropipettes, lab training and electrical power. The whole extraction process is performed within five minutes providing pure RNA adequate for downstream applications.

Results: A total of 410 nasopharyngeal swabs has been tested (including 150 COVID-positive subjects). All clinical isolates were extracted by the SmartLid and the gold standard QIAmp Viral RNA methods and tested by the CDC RT-qPCR assays. The SmartLid method achieved 93.9% sensitivity and 99.5% specificity compared to the QIAmp Viral RNA showing equivalent performance.

Conclusions/Learning Points: The extraction method presented can compete favourably with conventional laboratory-based extraction techniques which require expensive equipment and electricity, and which incur delays of over 45 minutes. The method has received overwhelmingly positive feedback from collaborators, who have tested it in CAT3 laboratory environments, and from visiting clinicians with experience in LMIC diagnostics. Thus, there is a clear interest for implementation in a domestic clinical/laboratory setting (NHS), and LMIC remote point-of-care setting.

MYXOVIRUS RESISTANCE PROTEIN A FOR DISCRIMINATING BETWEEN VIRAL AND BACTERIAL LOWER RESPIRATORY TRACT INFECTIONS IN CHILDREN – THE TREND STUDY

Oral Presentations Session

ORAL PRESENTATION SESSION 10: BIOMARKERS & DIAGNOSTICS

Samuel Rhedin¹, Annika Eklundh², Malin Ryd-Rinder³, Ville Peltola⁴, Matti Waris⁵, Jesper Gantelius⁶, Magnus Lindh⁷, Maria Andersson⁷, Giulia Gaudenzi⁸, Andreas Mårtensson⁹, Pontus Naucclér¹⁰, Tobias Alfvén²

¹Sachs' Children and Youth Hospital/Karolinska Institutet, Department Of Medical Epidemiology And Biostatistics, Stockholm, Sweden, ²Karolinska Institutet/Sachs' Children and Youth Hospital, Department Of Global Public Health, Stockholm, Sweden, ³Karolinska Institutet, Department Of Women's And Children's Health, Solna, Sweden, ⁴Turku University, Department Of Paediatrics And Adolescent Medicine, Turku University Hospital,, Turku, Finland, ⁵University of Turku and Clinical Microbiology, Turku University Hospital, Finland, Institute Of Biomedicine, Turku, Finland, ⁶Royal Institute of Technology, Science For Life Laboratory, Solna, Sweden, ⁷University of Gothenburg, Department Of Infectious Diseases, Gothenburg, Sweden, ⁸Karolinska Institutet, Department Of Global Public Health, Stockholm, Sweden, ⁹Uppsala University, Department Of Women's And Children's Health, International Maternal And Child Health (imch), Uppsala, Sweden, ¹⁰Karolinska Institutet and Karolinska University Hospital, Division Of Infectious Diseases, Department Of Medicine, Karolinska Institutet, Stockholm, Sweden. Department Of Infectious Diseases, Department Of Medicine, Solna, Sweden

Backgrounds: Discriminating between viral and bacterial lower respiratory tract infection (LRTI) in children is challenging, leading to an excessive use of antibiotics. Myxovirus resistance protein A (MxA) is a promising biomarker for viral infections. The aim of the study was to assess the difference in blood MxA levels between children with viral and bacterial LRTI and to assess MxA levels in relation to specific respiratory viruses.

Methods: Children with lower respiratory tract infection (LRTI) were enrolled as cases at Sachs' Children and Youth Hospital, Stockholm, Sweden. Nasopharyngeal aspirates (for respiratory PCR analysis) and blood samples (for analysis of MxA and CRP) were systematically collected from all study subjects in addition to standard laboratory/radiology assessment. Aetiology was defined according to an algorithm based on laboratory and radiological findings. The diagnostic accuracy of MxA was assessed by calculating sensitivity, specificity and area under the curve (AUC) in receiving operator characteristic (ROC) curves.

Results: Of the 326 cases, 242 had viral aetiology, 11 had mixed viral-bacterial aetiology, 5 had bacterial aetiology, 2 had atypical bacterial aetiology, and 66 cases had undetermined aetiology. MxA levels were higher in children with viral LRTI as compared with bacterial LRTI ($p < 0.01$, AUC 0.92). In the subgroup of children with pneumonia diagnosis, a cut-off of MxA 430 µg/l discriminated between viral and bacterial aetiology with 93% sensitivity and 100% specificity (AUC 0.98). The highest MxA levels were seen in cases PCR positive for adenovirus and respiratory syncytial virus (median MxA 1961 µg/l and 1226 µg/l respectively).

Conclusions/Learning Points: MxA accurately discriminated between viral and bacterial etiology in children with LRTI, in particular in the group of children with pneumonia diagnosis. Thus, MxA determination might improve rational use of antibiotics in this patient group.

O072 / #875

INTRODUCING HEART RATE VARIABILITY MONITORING COMBINED WITH BIOMARKER SCREENING INTO A LEVEL IV NICU: A PROSPECTIVE IMPLEMENTATION STUDY

Oral Presentations Session

ORAL PRESENTATION SESSION 10: BIOMARKERS & DIAGNOSTICS

Serife Kurul¹, Nicky Van Ackeren¹, Tom Goos¹, Christian Ramakers², Jasper Been¹, Sinno Simons¹, Irwin Reiss¹, René Kornelisse¹, H. Taal¹

¹Erasmus MC, University Medical Center-Sophia Children's Hospital, Neonatology, Rotterdam, Netherlands, ²Erasmus MC, University Medical Center, Clinical Chemistry, Rotterdam, Netherlands

Backgrounds: Late-onset neonatal sepsis (LONS) is a major complication in preterm neonates. Early recognition, by means of heart rate variability (HRV) monitoring, could help to guide early therapy and thereby improve outcome. The aim of this study was to investigate the association between the implementation of a local HRV-monitoring guideline in a level-IV NICU on mortality, measures of sepsis severity, frequency of sepsis testing and antibiotic usage among very preterm neonates.

Methods: In January 2018 a local guideline was implemented for early detection of LONS using HRV-monitoring combined with determination of inflammatory biomarkers. Data on all patients admitted with a gestational age at birth of <32 weeks were reviewed in the period January 2016-June 2020 (n=1,135; pre-implementation period Jan 2016-Dec 2017 (n=515), and post-implementation period Jan 2018-Jun 2020 (n=620)).

Results: In the study period, a total of 811 blood cultures in 473 neonates were withdrawn. Of these episodes, 490 (60.4%) were classified as sepsis. In the pre-implementation period, death within 10 days of start of the sepsis episode occurred in 39 (10.3%) episodes and in the post-implementation period it occurred in 34 (7.6%) episodes (P = 0.21). The nSOFA course during a sepsis episode was significantly lower in the post-implementation group (P = 0.01). We observed no statistically significant difference in number of blood cultures drawn and in antibiotic usage between the two periods.

Conclusions/Learning Points: Implementing HRV-monitoring with determination of inflammatory biomarkers might help identify patients with sepsis sooner, resulting in improved outcome, without an increased use of antibiotics or blood cultures withdrawals.

O073 / #949

TRAVELFEVER: CAN A STANDARD RAPID DIAGNOSTIC TEST ALONE SAFELY RULE OUT IMPORTED MALARIA IN CHILDREN PRESENTING TO THE EMERGENCY DEPARTMENT? A PERUKI NETWORK STUDY

Oral Presentations Session

ORAL PRESENTATION SESSION 10: BIOMARKERS & DIAGNOSTICS

Chris Bird¹, Thomas Fanshawe², Vanessa Merrick³, Philip Turner⁴, Mark Lyttle⁵, Stuart Hartshorn¹, Niall Mullen⁶, Gail Hayward⁴

¹Birmingham Women's and Children's NHS Foundation Trust, Emergency Department, Birmingham, United Kingdom, ²NIHR Community Healthcare MIC, Medical Statistics Group, Oxford, United Kingdom, ³Imperial College Healthcare NHS Trust, Emergency Department, St Mary's Hospital, London, United Kingdom, ⁴NIHR Community Healthcare MIC, Diagnostics, Oxford, United Kingdom, ⁵University Hospitals Bristol NHS Foundation Trust, Emergency Department, Bristol, United Kingdom, ⁶South Tyneside and Sunderland NHS Foundation Trust, Emergency Department, Sunderland Royal Hospital, Sunderland, United Kingdom

Backgrounds: Microscopy is the gold standard for malaria diagnosis but is time intensive and often requires repeat hospital visits. Rapid diagnostic tests (RDT) form the mainstay of diagnosis in many endemic areas. Could an RDT alone rule out imported malaria in children presenting to UK Emergency Departments (ED)?

Methods: UK-based, multi-centre, retrospective, diagnostic accuracy study. Cases: any child <16 years presenting to ED with history of fever and travel to a malaria endemic area, between 01/01/2016 and 31/12/2017. Diagnosis: microscopy for malarial parasites (clinical reference standard) and RDT (index test). UK Health Research Authority approval: 20/HRA/1341.

Results: 51 malaria cases were reported in 1,472 patients documented at 15 sites (prevalence 3.5%), of which 44% female, median age 5 years (interquartile range 2-9 years). There were two deaths but not from malaria. Sensitivity of RDT alone to detect malaria infection was 94.1% (95% CI 83.8%-98.8%), specificity 99.4% (95% CI 98.8-99.7%), positive predictive value (PPV) 84.2% (95% CI 72.1-92.5%) and negative predictive value (NPV) 99.8% (95% CI 99.4-100.0%) (see Figure 1).

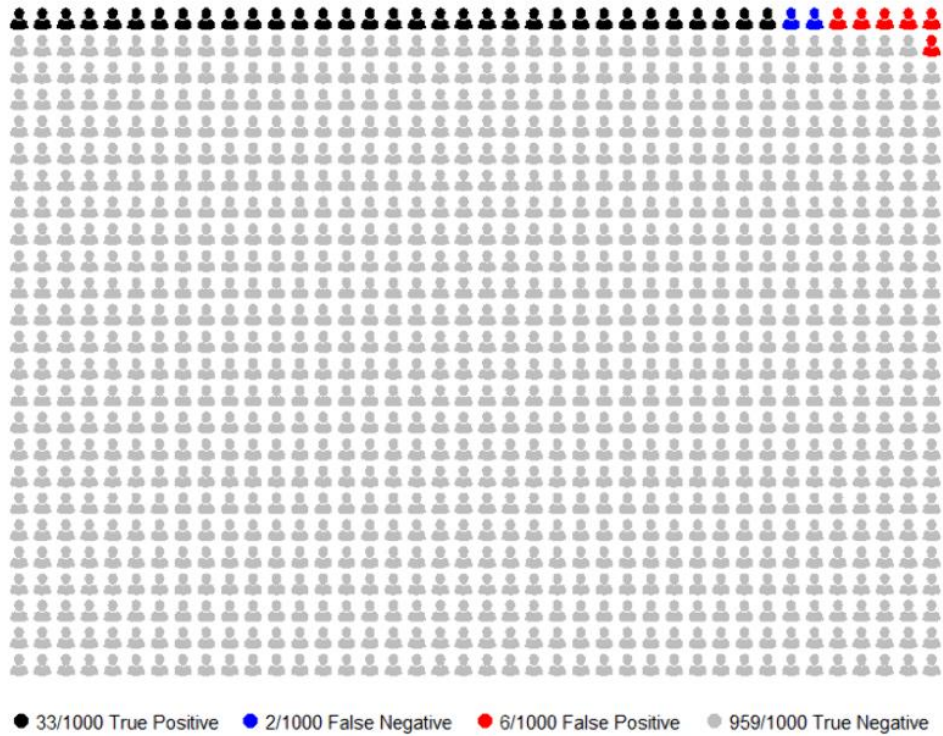

Figure 1. Personogram showing expected numbers of RDT results in hypothetical sample of 1000 children (all malaria species). Forty (78%) cases were due to *P falciparum*. Sensitivity of RDT alone to detect *P falciparum* was 100% (95% CI 91.2-100%), specificity 98.8% (95% CI 98.1-99.3%), PPV 70.2% (95% CI 56.6%-81.6%) and NPV 100% (95% CI 99.7-100%).

Conclusions/Learning Points: Standard RDTs were 100% sensitive in detecting *P falciparum* malaria in children in this study, with a lower point estimate for all malaria species. RDT alone can likely rule out imported *P falciparum* malaria in well-appearing children but a prospective study should confirm this, especially with the emergence of *pfhrp2/3* gene deletions in the *P falciparum* parasite.

O074 / #608

DISCRIMINATION OF VIRAL FROM BACTERIAL COMMUNITY ACQUIRED PNEUMONIA IN CHILDREN USING URINE METABOLOMICS

Oral Presentations Session

ORAL PRESENTATION SESSION 10: BIOMARKERS & DIAGNOSTICS

Lilliam Ambroggio¹, Todd Florin², Kayla Williamson¹, Brandie Wagner¹, Larisa Yeomans³, Heidi Sucharew⁴, Maurizio Macaluso⁴, Richard Ruddy⁴, Samir Shah⁴, Kathleen Stringer³

¹Children's Hospital Colorado, Pediatrics, Aurora, United States of America, ²Lurie Children's Hospital, Pediatrics, Chicago, United States of America, ³University of Michigan, Pharmacy, Ann Arbor, United States of America, ⁴Cincinnati Children's Hospital Medical Center, Pediatrics, Cincinnati, United States of America

Backgrounds: Differentiating bacterial from viral etiologies of pediatric community-acquired pneumonia (CAP) is critical to guiding appropriate therapy. However, current tests are insensitive, invasive, or impractical in children. The objective of this study is to identify candidate metabolomic biomarkers that differentiate bacteria from viral CAP.

Methods: We studied a cohort of children, 3 months-18 years old, with suspected CAP in the emergency department. Patients with chronic medical conditions or who were hospitalized 14 days prior were excluded. Viral and *Mycoplasma pneumoniae* (Mp) were detected by PCR of nasopharyngeal swabs. Suspected *Streptococcus pneumoniae* (Sp) was defined as presence of pneumococcal autolysin (lytA) and a procalcitonin of ≥ 1.5 ng/mL. Urine samples were collected at time of presentation and metabolites were identified and quantified by nuclear magnetic resonance spectroscopy. Metabolomics data were standardized using specific gravity. Demographic and clinical characteristics by patient status (MP, Sp and viral) were compared using chi-square tests and ANOVA, as applicable. Random forest (RF) was used to determine the most important metabolites and clinical factors to discriminate viral etiology from Mp and Sp.

Results: Of 160 children, 28 (17.5%) had Mp, 13 (8.1%) had Sp, and 119 (74.4%) had a virus detected by PCR (Table). Most (87%) were between 1-12 years old. The most important variables identified by RF included age, prior history of reactive airways disease, 1-methylnicotinamide, hypoxanthine, tryptophan, quinolinate, valine, trimethylamine-N-oxide, ascorbate, and 4-hydroxybenzoate.

| Characteristic | All (n=160) | <i>Mycoplasma pneumoniae</i> (n=28) | <i>Streptococcus pneumoniae</i> (n=13) | Virus (n=119) | P-Value |
|-------------------------------|---------------------|-------------------------------------|--|----------------------|---------|
| Age | | | | | 0.01 |
| <3 months to 1 year | 23 (15%) | 0 (0%) | 0 (0%) | 23 (19%) | |
| >1 year to 5 years | 77 (50%) | 8 (36%) | 7 (54%) | 62 (52%) | |
| >5 years to 12 years | 54 (35%) | 14 (64%) | 6 (46%) | 34 (29%) | |
| Female Gender | 79 (49%) | 14 (50%) | 7 (54%) | 58 (49%) | 0.94 |
| Asthma | 42 (26%) | 2 (7%) | 2 (17%) | 36 (32%) | 0.03 |
| Parent Reported Symptoms | | | | | |
| Fever | 142 (89%) | 27 (96%) | 12 (92%) | 103 (87%) | 0.40 |
| Cough | 155 (97%) | 28 (100%) | 10 (77%) | 117 (98%) | <0.01 |
| Difficulty Breathing | 140 (88%) | 20 (71%) | 10 (77%) | 110 (92%) | <0.01 |
| Wheezing | 105 (66%) | 15 (54%) | 3 (23%) | 87 (73%) | <0.01 |
| Noisy Breathing | 120 (75%) | 12 (43%) | 7 (54%) | 101 (85%) | <0.01 |
| Rapid Breathing | 134 (84%) | 16 (57%) | 9 (69%) | 109 (92%) | <0.01 |
| Decreased oral intake | 112 (70%) | 14 (50%) | 8 (62%) | 90 (76%) | 0.03 |
| Runny Nose/Congestion | 126 (85%) | 18 (64%) | 11 (85%) | 107 (90%) | <0.01 |
| Prior Antibiotics | | | | | |
| Amoxicillin | 29 (18%) | 12 (43%) | 1 (8%) | 16 (13%) | <0.01 |
| Augmentin | 4 (2%) | 3 (11%) | 0 (0%) | 1 (1%) | 0.03 |
| Azithromycin | 8 (5%) | 1 (4%) | 1 (8%) | 6 (5%) | 0.68 |
| Biomarkers | | | | | |
| White Blood Count | 11.15 (7.8, 15.475) | 8.8 (7.7, 12.6) | 25.6 (18.4, 27.95) | 10.9 (7.575, 14.375) | <0.01 |
| C-Reactive Protein | 2.5 (1.075, 6.225) | 2.275 (0.9425, 6.2675) | 15.7 (7.32, 22.2) | 2.2 (0.96, 4.82) | <0.01 |
| Procalcitonin | 0.36 (0.1, 1.175) | 0.15 (0.09, 0.425) | 5.4 (2.63, 10.65) | 0.325 (0.1, 0.935) | <0.01 |
| ESR | 29 (7, 57) | 6 (6, 6) | 29 (29, 29) | 33 (8.5, 55) | 0.50 |
| Chest X-Ray Findings | | | | | <0.01 |
| Normal | 6 (4%) | 0 (0%) | 1 (8%) | 5 (4%) | |
| Probable/Definite atelectasis | 85 (53%) | 3 (11%) | 2 (15%) | 80 (67%) | |
| Atelectasis vs. pneumonia | 12 (8%) | 2 (7%) | 2 (15%) | 8 (7%) | |
| Probable/definite pneumonia | 57 (36%) | 23 (82%) | 8 (62%) | 26 (22%) | |
| Admit Disposition | 113 (71%) | 15 (54%) | 8 (62%) | 90 (76%) | 0.05 |

Conclusions/Learning Points: Metabolites related to inflammatory pathways (e.g., tryptophan, quiniolate) and microbial metabolism (e.g., trimethylamine-N-oxide, 4-hydroxybenzoate) differentiated viral from typical and atypical bacterial CAP in children. Urine metabolomics can identify novel biomarkers to differentiate bacterial from viral CAP in children.

BV SCORE'S PERFORMANCE WHEN APPLIED ACCORDING TO INDICATIONS FOR USE AS PART OF ROUTINE CARE FOR CHILDREN PRESENTING TO THE ED WITH FEVER WITHOUT SOURCE

Oral Presentations Session

ORAL PRESENTATION SESSION 10: BIOMARKERS & DIAGNOSTICS

Adi Klein^{1,2}, Shelly Lipman-Arens^{2,3}, Ellen Bamberger^{2,4}, Isaac Srugo⁴, Irina Chistyakov⁵, Michal Stein^{2,3}
¹Hillel Yaffe Medical Center, Pediatrics, Hadera, Israel, ²Technion Institute of Technology, Rappaport Faculty Of Medicine, Haifa, Israel, ³Hillel Yaffe, Infectious Diseases, Hadera, Israel, ⁴Bnai Zion, Pediatrics, Haifa, Israel, ⁵Bnai Zion, Emergency Medicine, Haifa, Israel

Backgrounds: Up to 20% of febrile pediatric patients presenting to the emergency department (ED) will not have a source identified by history or physical examination. Most of these patients have self-limiting viral illnesses, but ~10% could be bacterially infected. A host-protein bacterial likelihood score (BV score) based on TRAIL, IP-10 and CRP has demonstrated high performance for differentiating bacterial from viral infections in multiple validation studies. Here we evaluate for the first time BV Score's performance when applied according to instructions for use in routine care of children presenting to the ED with fever without source (FWS).

Methods: A retrospective analysis of patients aged 3 months to 18 years at two medical centers for whom BV score was measured as part of routine care (NCT03075111; 2014–2017). For each patient, the physician documented suspected clinical syndrome at the time of blood draw for BV score. TRAIL and IP-10 were measured, and BV score calculated using ImmunoXpert™. CRP was measured using COBASc501. Reference standard for infection etiology was adjudicated by 3 independent experts based on the patient's clinical, laboratory and microbiologic data.

Results: 2160 of 3006 patients met the current indication for use for measuring the BV score, of whom 788 were documented by the physician as suspected FWS; 69 patients were adjudicated as bacterial, 518 as viral and 201 as indeterminate. Median age was 2 years (IQR 4.08), 53% were male. The BV score attained sensitivity of 88.1% (95% CI, 77.1%-95.1%), specificity of 93.7% (91.1%-95.8%) and NPV of 98.4% (96.8%-99.2%). The equivocal rate was 13.1%.

Conclusions/Learning Points: The BV score demonstrated high diagnostic performance when applied according to its indication for use as part of routine care for children presenting to the ED with FWS.

O076 / #1163

DIAGNOSTIC PERFORMANCE IN A MULTICENTRE STUDY USING FULL BLOOD COUNTS FOR THE NEUTROPHIL-TO-LYMPHOCYTE AND MONOCYTE-TO-LYMPHOCYTE RATIO FOR THE DIAGNOSIS OF PAEDIATRIC TUBERCULOSIS

Oral Presentations Session

ORAL PRESENTATION SESSION 10: BIOMARKERS & DIAGNOSTICS

Nora Fritschi^{1,2}, Mirjam Kissling¹, Philipp Baumann^{3,4}, Jan Bonheoffer⁴, Michael Buettcher⁵, Nicole Ritz¹

¹University children hospital Basel, Mycobacterial Research, Basel, Switzerland, ²University Children Hospital Basel, Emergency, Basel, Switzerland, ³University Children`s Hospital Zurich, Department Of Intensive Care Medicine And Neonatology, Zurich, Switzerland, ⁴University of Basel Children`s Hospital, Department Of Paediatric Infectious Diseases And Vaccines, Basel, Switzerland, ⁵Pediatric Infectious Diseases Unit, Lucerne Cantonal Hospital, Lucerne, Switzerland

Backgrounds: The monocyte-to-lymphocyte ratio (MLR) and neutrophil-to-lymphocyte ratio (NLR) are easy to obtain markers from full blood counts. Little is known about the diagnostic accuracy of these ratios in children evaluated for tuberculosis (TB) compared to sick controls.

Methods: Data of two prospective multicentre studies in Switzerland were used: the CITRUS study and the ProPAED study. The CITRUS study included children <18 years with TB exposure (TB-E), TB infection (TB-I) or TB disease (TB-D). The ProPAED study included children 1 month to 18 years of age with fever and lower respiratory tract infection (viral or bacterial) and these were the sick controls (SC).

Results: A total of 379 children were included in this analysis; 19 with TB-D, 12 with TB-I, 24 TB-E and 324 SC. Median age was 3.08 (IQR [1.37, 6.06]) years and 58% were male. Median NLR was highest in TB-D (2.05 [1.41, 2.64]) and significantly higher compared to children with TB-I (1.08 [0.82, 1.55]), TB-E (0.80 [0.63, 1.33]) and SC (0.31 [0.11, 0.97]) (all p-values < 0.05). Median MLR was similar in TB-D (0.25 [0.18, 0.34]) and SC (0.34 [0.21, 0.58]), but significantly higher in TB-D and TB-I when compared to TB-E (both p-values <0.05). Receiver operating characteristic curves of the ratios were calculated for children with TB-D and SC. NLR and MLR had at cut-off 0.75 and 0.63, an area under the curve of 0.84 and 0.63, sensitivity of 0.94 and 0.94, and specificity of 0.7 and 0.3, respectively. Similar results were obtained after adjustment for age.

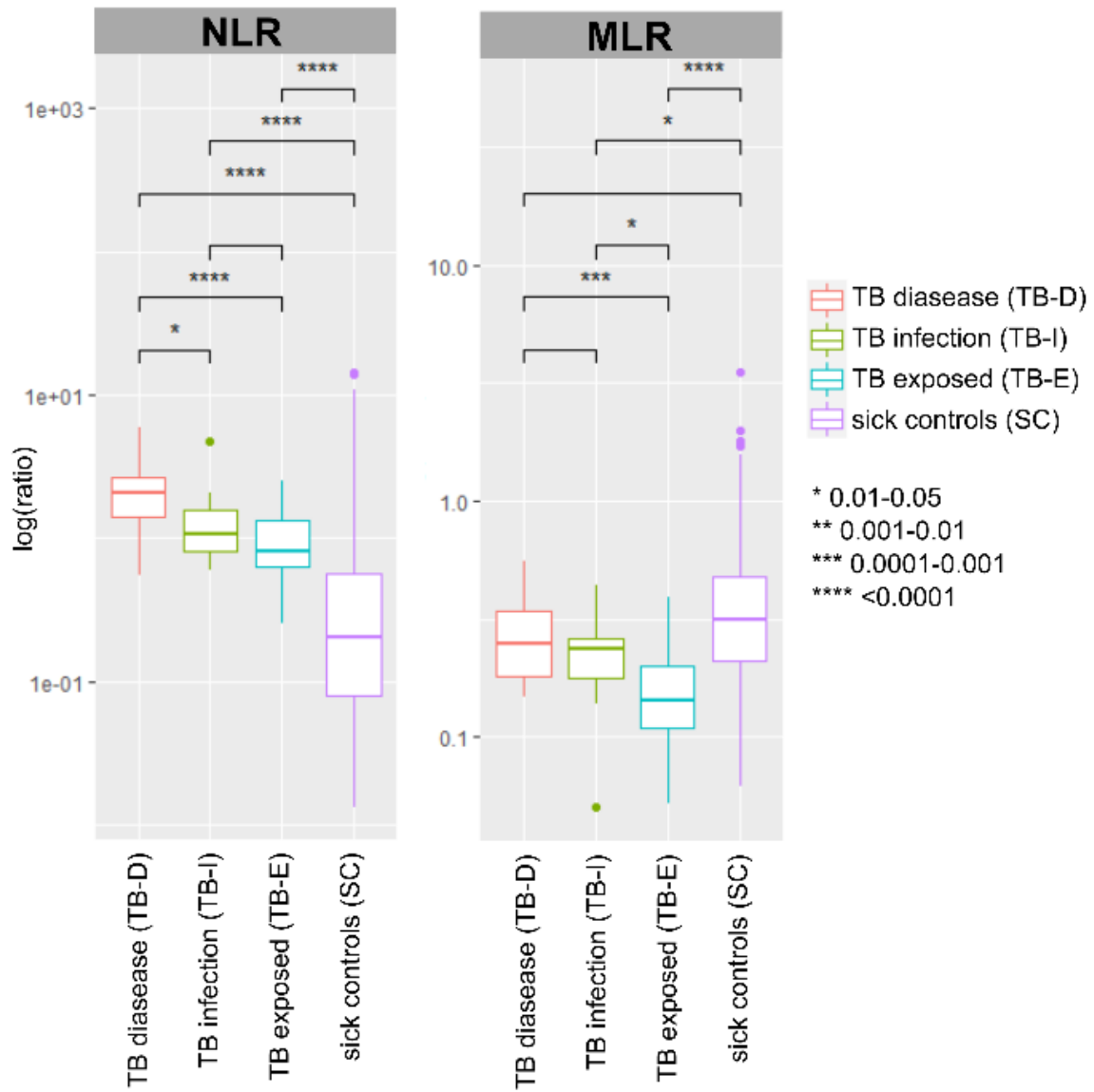

Conclusions/Learning Points: This study shows that NLR and MLR are promising easy-to-obtain diagnostic markers to differentiate children TB-D from non-TB lower respiratory tract infections. These results require confirmation in a larger study sample.

CASE REPORT: SEVERE ACUTE PULMONARY COVID-19 IN A TEENAGER POST AUTOLOGOUS HAEMATOPOIETIC STEM CELL TRANSPLANT

E-Posters
MEET THE EXPERT POSTERS

Fabian Van Der Velden^{1,2}, Frederik Van Delft³, Stephen Owens², Judit Llevadias⁴, Michael Mckean⁵, Lindsey Pulford⁴, Yusri Taha⁶, Grace Williamson⁷, Quentin Campbell-Hewson³, Sophie Hambleton^{1,2}, Rebecca Payne¹, Christopher Duncan¹, Catriona Johnston⁸, Jarmila Spegarova¹, Marieke Emonts^{1,2}

¹Newcastle University, Translational And Clinical Research Institute, Newcastle upon Tyne, United Kingdom, ²Great North Children's Hospital, Paediatric Immunology, Infectious Diseases And Allergy, Newcastle upon Tyne, United Kingdom, ³Great North Children's Hospital, Paediatric Oncology, Newcastle upon Tyne, United Kingdom, ⁴Freeman Hospital, Newcastle upon Tyne Hospitals NHS Foundation Trust, Paediatric Intensive Care, Newcastle upon Tyne, United Kingdom, ⁵Great North Children's Hospital, Paediatric Respiratory Department, Newcastle upon Tyne, United Kingdom, ⁶Newcastle upon Tyne Hospitals NHS Foundation Trust, Virology, Newcastle upon Tyne, United Kingdom, ⁷Great North Children's Hospital, Paediatric Intensive Care, Newcastle upon Tyne, United Kingdom, ⁸Newcastle upon Tyne Hospitals NHS Foundation Trust, Pharmacy, Newcastle upon Tyne, United Kingdom

Title of Case: CASE REPORT: SEVERE ACUTE PULMONARY COVID-19 IN A TEENAGER POST AUTOLOGOUS HAEMATOPOIETIC STEM CELL TRANSPLANT

Background: Pulmonary COVID-19 infection in children, including immunocompromised, is generally described mild. A small proportion of children will become critically ill due to (cardio)respiratory failure, and require intensive care treatment.

Case Presentation Summary:

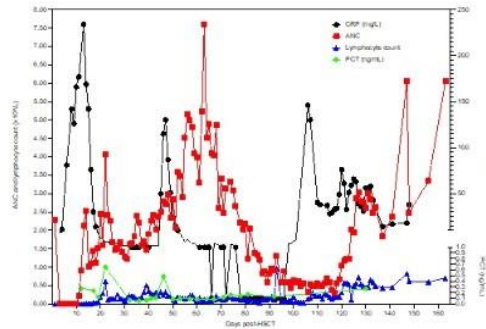
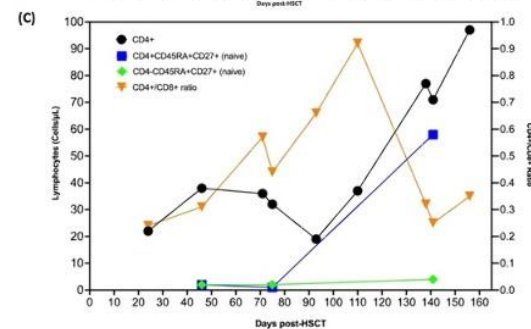
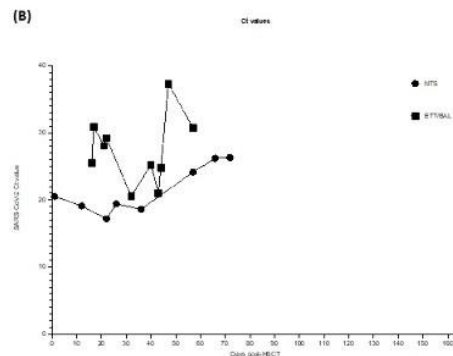
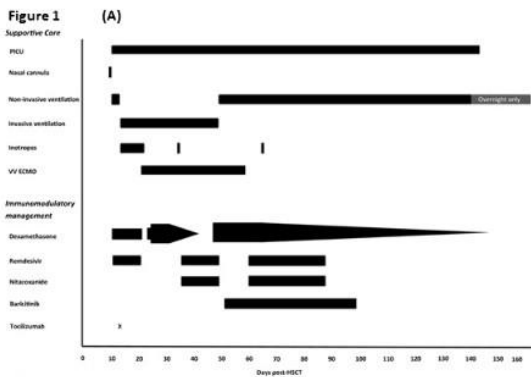

We report a teenager with Hodgkin's lymphoma who acquired SARS-CoV-2 (PCR positive) on the day of her autologous stem cell transplant and developed acquired respiratory distress syndrome (ARDS) on

day+10. Initially she received remdesivir, dexamethasone, and tocilizumab for COVID-19 with sepsis cover. Following further clinical pulmonary deterioration she was intubated and ventilated, put on venovenous ECMO, and received a tracheostomy. Given persistent low SARS-CoV-2 Ct-values she received two further courses of remdesivir/dexamethasone with nitazoxanide experimentally added, and baricitinib for inflammation control (Figure 1). She slowly improved and remdesivir/nitazoxanide were stopped after 2 weeks of PCR SARS-CoV-2 negativity (Day+72), dexamethasone weaned. ECMO was stopped after 39 days (Day+57), she was discharged from PICU after 132 days (Day+143), and discharged to local hospital for rehabilitation on Day+218. She is currently home with a reduced lung function, but able to go to school. Neutrophil reconstitution was observed on day+12, lymphocyte reconstitution on day+120. Naïve T-lymphocytes appeared from day+140. Despite low CD4-lymphocyte counts (CD4/CD8-ratio 0.29), and JAK-inhibitor exposure, we observed specific SARS-CoV-2 antigen responses. Compared to seropositive controls, she had a higher proportion of IL-2 producing CD-4 lymphocytes in response to S1 and S2 spike peptide pools, but poor interferon gamma and TNF alpha response.

Learning Points/Discussion: We describe successful treatment in a paediatric patient with COVID-19 ARDS, acquired at time of stem cell transplant, with ECMO, antivirals and immunomodulation. We demonstrate SARS-CoV-2 specific cellular and humoral response development, despite ongoing immunosuppression.

PD002 / #739

Topic: AS13. COVID 19 and MIS-C

INFANT WITH SARS-COV-2 INFECTION CAUSING SEVERE LUNG DISEASE

E-Posters

MEET THE EXPERT POSTERS

Sofia Benou, Dimitrios Kapnisis, Gabriel Dimitriou, Despoina Gkentzi
General University Hospital of Patras, University of Patras, Department Of Paediatrics, Patras, Greece

Title of Case: INFANT WITH SARS-COV-2 INFECTION CAUSING SEVERE LUNG DISEASE

Background: Infants with SARS-Cov2 infection may be at higher risk of hospitalization and severe outcomes. We report a case of an infant with SARS-CoV2 infection that developed acute respiratory failure.

Case Presentation Summary: A 55-day-old full-term male infant was referred to our Paediatric Department with a history of one-day fever, rhinitis and SARS-CoV2 RT-PCR positive. On admission, he had normal vital signs, low grade fever and rhinitis. Laboratory evaluation revealed mildly elevated HS-Troponin (67 pg/ml) and elevated ferritin (2327 ng/ml). During the course of the disease, the infant had low-grade-fever for 2 days, nasal congestion and he was discharged after 3 days of hospitalization. After 36 hours, he was readmitted due to poor feeding and developed tachypnoea and hypoxia, rhinitis and suprasternal-subcostal retractions. Laboratory tests showed AST=393U/l, ALT=234U/l, LDH=798U/l and chest X-ray showed bilateral alveolar consolidations and lobal consolidation in right upper lobe. He received oxygen, IV ceftriaxone, remdesivir and dexamethasone. Because of the increased oxygen requirement, he was transferred to ICU, where he underwent invasive-mechanical ventilation for 9-days. Bronchial specimen culture was negative for bacterial pathogens but a respiratory PCR-panel-assay on nasopharyngeal swab was not performed. RSV antigen was negative. Because of extremely elevated value of ferritin (18000 ng/ml), a bone-marrow biopsy was performed to exclude Hemophagocytic Lymphohistiocytosis. After 16 days of ICU admission, he was discharged fully recovered. Baseline immunological work up was normal.

Learning Points/Discussion: This case highlights the importance of laboratory findings such as ferritin in the prediction of SARS-CoV2 infection outcome in children. Infants presenting severe COVID-19 with hyperinflammatory response require further work up for comorbidities and underlying immunodeficiencies as well as follow up for post-COVID sequelae.

PD003 / #869

Topic: AS13. COVID 19 and MIS-C

INTRAVENOUS ADMINISTRATION OF IL-1B BLOCKER WITH EXCELLENT RESULTS IN A CASE OF MIS-C

E-Posters

MEET THE EXPERT POSTERS

Konstantina Patouni¹, Despoina Maritsi², Elisavet Kassari¹, Evgenia Zisimou¹, Katerina Oikonomopoulou¹, Dimitrios Delis¹, Mersyni Mavrikou¹

¹"P&A Kyriakou" Children's Hospital, First Paediatric Department, Athens, Greece, ²"P& A Kyriakou" Children's Hospital, Second Department Of Paediatrics, National And Kapodestrian University Of Athens, Athens, Greece

Title of Case: Intravenous administration of IL-1b blocker with excellent results in a case of MIS-C

Background: Multisystemic inflammatory syndrome in children (MIS-C) is a new clinical entity associated with previous infection with Sars-Cov-2 which emerged during the pandemic. It is characterized by fever, increased inflammatory markers and multisystemic inflammation in the absence of an alternate diagnosis.

Case Presentation Summary: A previously healthy 10-year-old boy was admitted with a 3 day history of unremitting high fever, morbilliform rash, diarrhea and abdominal pain. Upon admission, the patient was tachycardic, while non purulent conjunctivitis, generalized macular rash, red cracked lips, abdominal distention and tenderness were noted. Initial laboratory tests revealed increased inflammatory markers, mild thrombocytopenia and hyponatremia. Heart echo showed a small dilation of the main stem of the left coronary artery, while troponin and pro-BNP levels were elevated. Despite prompt initiation of treatment with IVIG (2gr/kg) and methylprednisolone pulses, the patient's clinical condition deteriorated on day 2 of his hospitalization. He developed limb and face edema and respiratory distress, accompanied with deterioration of inflammatory markers and hypoalbuminemia. Chest X-ray revealed left lung consolidation with pleural effusion. The abdominal ultrasound showed pericholecystic edema and eleitis. He was subsequently treated with intravenous Anakinra (8mg/kd/day). He showed excellent response with rapid improvement of clinical and laboratory findings and echocardiography. He was discharged in good clinical condition.

Learning Points/Discussion: Prompt recognition and treatment of MIS-C are crucial in order to achieve better outcomes. In case of clinical deterioration whilst on maximum methylprednisolone regime, prompt initiation of IL-1b blocker via the intravenous route may radically ameliorate the outcome.

PD004 / #1101

Topic: AS07. Non-respiratory infections / AS07.c. CNS infections

TICK BORNE ENCEPHALITIS INDUCED ACUTE NECROTIZING ENCEPHALOPATHY OF CHILDHOOD: A CASE REPORT

E-Posters

MEET THE EXPERT POSTERS

Lizete Klavina^{1,2}, Dace Seile³, Guntis Rozentals³, Mikus Diriks³

¹Riga Stradins University, Department Of Paediatrics, Riga, Latvia, ²Children's Clinical University Hospital, Department Of Paediatrics, Riga, Latvia, ³Children's Clinical University Hospital of Latvia, Department Of Paediatric Neurology, Riga, Latvia

Title of Case: TICK BORNE ENCEPHALITIS INDUCED ACUTE NECROTIZING ENCEPHALOPATHY OF CHILDHOOD: A CASE REPORT

Background: Acute necrotizing encephalopathy of childhood (ANEC) is a multifactorial disease that is induced by viral infection and presents with rapid neurological deterioration, decreased level of consciousness, seizures and focal neurological deficit. We want to present the first case of tick-borne encephalitis (TBE) induced ANEC.

Case Presentation Summary: Previously healthy 8 years old boy was first admitted to hospital presenting with generalized tonic-clonic seizure, subfebrile temperature (37.2°C), vomiting and positive meningeal signs. Cranial CT scan was normal, CSF analysis revealed cytosis and increased protein level, therefore empirical treatment with ceftriaxone, vancomycin and aciclovir was initiated. However, patient had second seizure, whereupon right side paresis was observed. Brain MRI showed multiple edematous areas, including thalamus bilaterally, basal ganglia and pons. It was known that the boy was bitten by a tick during summer, and CSF analyses showed positive TBE RNS by RT-PCR. Other microbiological analyses in CSF and blood were negative. Electroencephalography revealed changed brain's basic bioelectrical activity with slow rhythm and focal epileptiform discharges in right temporobasal region. On the seventh day of illness patient had worsening of general condition with recurrent seizures and additional left side paresis. Control brain MRI showed negative dynamic with necrotic changes in left thalamus and increasing edema. Genetic testing for immunodeficiencies and RANBP2 gene were negative. Patient was diagnosed with ANEC, and treatment with intravenous immunoglobulin and dexamethasone was initiated. Gradual improvement was observed, however, at the time of discharge severe neurologic sequelae remained with sensorimotor aphasia, dysphagia, cognitive impairment, asymmetric tetraparesis.

Learning Points/Discussion: Although ANEC is a rare condition, it should be promptly recognized as it may mimic vascular origin ischemic changes in brain, but treatment strategies differ.

PD005 / #1269

Topic: AS09. *Mycobacteria and retroviruses / AS09.a. Tuberculosis and other mycobacterial infections*

PONTINE TUBERCULOMA PRESENTING AS FEBRILE ATAXIA WITH BILATERAL FACIAL NERVE PALSY

E-Posters

MEET THE EXPERT POSTERS

Reepa Agrawal, Zahabiya Nalwalla, Akanksha Jaiswal, Ira Shah
Bai Jerbai Wadia Hospital for Children, Pediatric Center Of Excellence For Dr-tb, Department Of Pediatric Infectious Diseases, Mumbai, India

Title of Case: PONTINE TUBERCULOMA PRESENTING AS FEBRILE ATAXIA WITH BILATERAL FACIAL NERVE PALSY

Background: Central Nervous System- Tuberculosis (CNS-TB) ranges between 1-10% of all TB cases (1). It can be life-threatening and hence prompt diagnosis and treatment is paramount. We present a case report wherein a patient presented with bilateral lower motor neuron (LMN) facial nerve palsy , progressive ataxia and fever diagnosed to have Pontine Tuberculoma and improving with antitubercular drugs and steroids.

Case Presentation Summary: A 9 years old girl presented with history of progressive ataxia and low-grade fever for 10 days in September 2021. There was no history of recent Kochs contact, seizures, rashes, vaccination, headache, vomiting, breathing difficulty. On examination her Glasgow Coma Scale (GCS) score was 15/15, vitals were stable with no signs of raised intracranial pressure. She had bilateral LMN facial & abducens nerve palsy with ataxic gait and brisk reflexes. No neck rigidity. MRI Brain showed pontine tuberculoma with surrounding edema in mid-brain, medulla, cerebellum with mass effect causing 4mm tonsillar herniation and moderate hydrocephalus with mild periventricular ooze. . MR spectroscopy revealed large lipid peak papilledema detected, lumbar puncture not done. No other organ involved. Anti-TB drugs with steroids (@ 2 mg/kg/day) were started. Patient improved with follow up MRI showing reduction in the size of tuberculoma as well as resolution of hydrocephalus and clinically nerve palsies recovered.

Learning Points/Discussion: 1. Tuberculous etiology should be suspected, although rare to present with bilateral LMN facial nerve palsy in febrile ataxic child. 2. Initial presentation of pontine tuberculoma may not necessarily be associated with low GCS score or breathing difficulty however the cranial nerves palsies may help in suspecting localization of anatomical region. 3. Prognosis can improve with early diagnosis and prompt treatment.

PD006 / #1291

Topic: AS08. Respiratory infections (only non-SARS-CoV2 content) / AS08.b. Bacterial pneumonia

NECROTIZING PNEUMONIA CAUSED BY MRSA PRODUCING PANTON VALENTINE LEUKOCIDIN: A RARE CASE IN A 2-MONTH-OLD INFANT

E-Posters

MEET THE EXPERT POSTERS

Valeria Rubinacci¹, Elisabetta Gatti¹, Alice Proto², Laura Ilardi², Marco Fossati², Ottavio Vitelli², Fernando De Benedictis³, Stefano Martinelli²

¹ASST Grande Ospedale Metropolitano Niguarda, Neonatology And Neonatal Intensive Care Unit, Milan, Italy- University Of Milan, Milan Italy, Milan, Italy, ²ASST Grande Ospedale Metropolitano Niguarda, Neonatology And Neonatal Intensive Care Unit, Milan, Italy, ³Salesi Children's Hospital Foundation, Ancona, Italy, Department Of Mother And Child Health, Salesi Children's Hospital, Ancona, Italy, Ancona, Italy

Title of Case: NECROTIZING PNEUMONIA CAUSED BY MRSA PRODUCING PANTON VALENTINE LEUKOCIDIN: A RARE CASE IN A 2-MONTH-OLD INFANT

Background: Necrotizing Pneumonia (NP) is characterized by the destruction of lung tissue, development of pneumatoceles, cysts and abscesses, and associated parapneumonic effusion. Particularly severe forms, even in otherwise healthy subjects, have been associated with Staphylococcus aureus strains producing Panton-Valentine Leukocidin (PVL).

Case Presentation Summary: A 2-month-old infant presented with sudden onset tachypnea. Decreased breath sounds and fine crackles in the left lung were revealed. Oxygen saturation was 88-90% in air, and supplemental oxygen was therefore required. Laboratory tests showed 45.000/mm³ white blood cells (61% neutrophils), C-reactive protein 12,5 mg/dL and hyponatremia. Chest X-ray revealed opacified left hemithorax with multiple small cavities, left parapneumonic effusion, and mediastinal shift. Lung ultrasound showed left lung consolidation and echogenic pleural effusion. Chest CT scan revealed small cavities and two large intraparenchymal cysts, thus confirming the suspect of PN. Empiric treatment with intravenous cefotaxime and vancomycin was started. On day 2, given the impending clinical severity, intubation was performed and a pleural drainage was positioned. Nasal swab, bronchial aspirate and pleural fluid cultures all tested positive for MRSA producing PVL. Antibiotic therapy was adjusted by replacing cefotaxime with ceftaroline, and vancomycin with clindamycin. Slow improvement of clinical conditions, inflammatory biomarkers, and radiological findings was obtained, and the child was eventually discharged after 4 weeks.

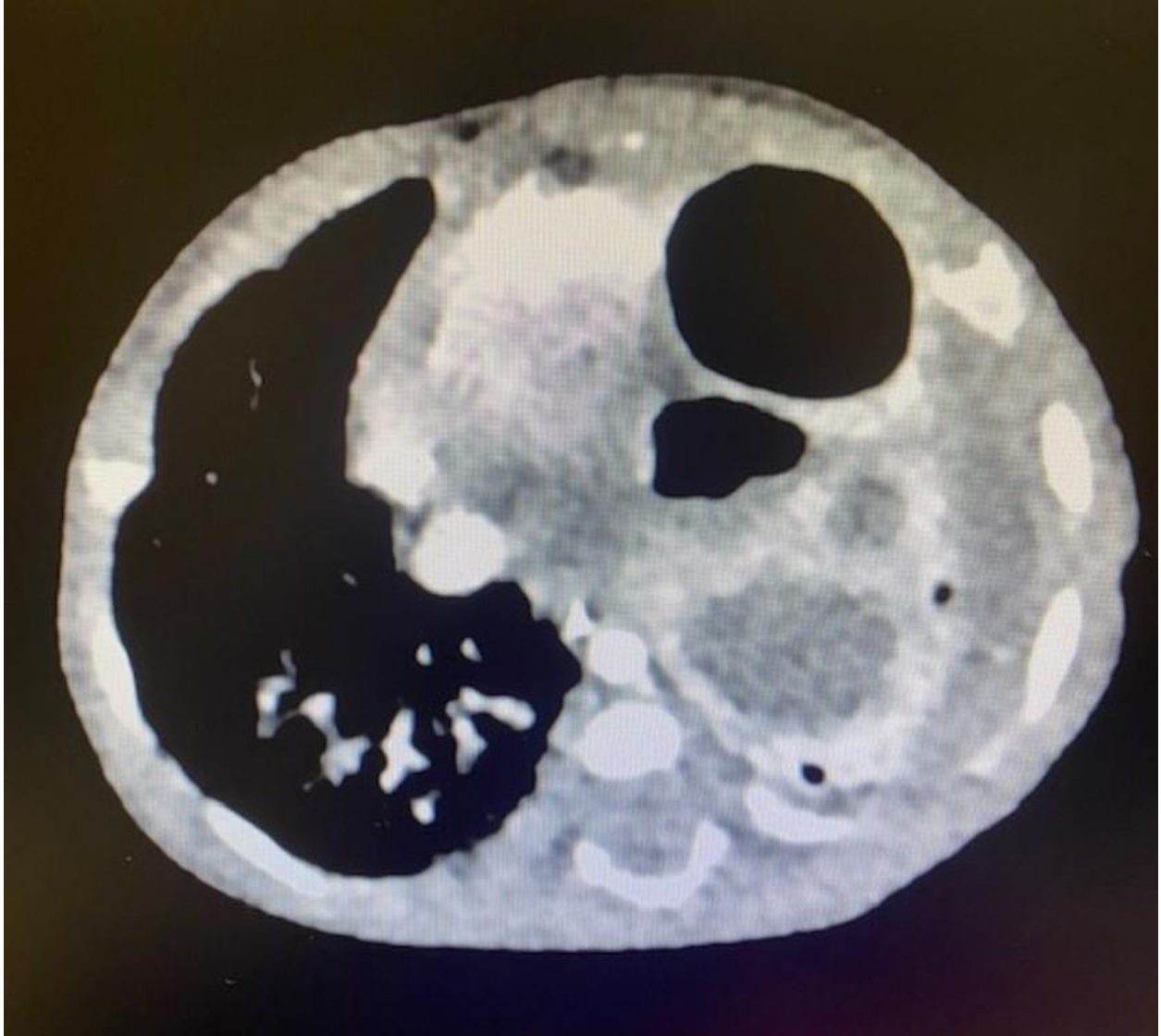

Learning Points/Discussion: NP is a severe and variably evolving condition that mainly occurs in young children. Our case is noteworthy since, as far as we know, it is the first description of NP so early in an infant. When dealing with similar cases, clinicians must remain alert regarding the possibility of MRSA-PVL positive strains, whose prompt identification is crucial for a favourable outcome.

PD007 / #1374

Topic: AS06. Infections in early life / AS06.a. Congenital and perinatal infections

THE IMPORTANCE OF A CORRECT FOLLOW UP OF BABIES BORN FROM HIV POSITIVE MOTHERS

E-Posters

MEET THE EXPERT POSTERS

Andrés Efraín Muy Pérez¹, Ana Isabel Dacosta Urbietta², María Montserrat López Franco², Irene Rivero Calle³, Federico Martínón-Torres⁴, Jose Antonio Couceiro Gianzo⁵, Rosaura Picans Leis¹, Rita García Fernández¹

¹Complejo Hospitalario Universitario de Santiago de Compostela, Pediatrics, Santiago de Compostela, Spain, ²Hospital Clínico de Santiago de Compostela, Pediatrics, Santiago de Compostela, Spain, ³GENVIP, Genetics, Vaccines, Infectious Diseases And Pediatrics Research Group., Santiago de Compostela, Spain, ⁴Hospital Clínico Universitario de Santiago de Compostela, Translational Paediatrics And Infectious Diseases, Paediatrics Department, Santiago de Compostela, Spain, ⁵Hospital Provincial de Pontevedra, Pediatrics, Pontevedra, Spain

Title of Case: THE IMPORTANCE OF A CORRECT FOLLOW UP OF BABIES BORN FROM HIV POSITIVE MOTHERS

Background: The vertical transmission rate by HIV has decreased below 1% in Spain thanks to the adoption of prophylactic measures and a correct maternal and neonatal follow-up. However, there are still cases that skip these measures, which can lead to important complications and sequelae.

Case Presentation Summary: A 13-year-old girl presented to our pediatric emergency room with a 1-month history of bradypsychia, dysarthria and left body hemiparesis. As the patient was a tourist from another city of Spain, electronic health records were not available. She had had 2 episodes of herpes zoster and bilateral hearing loss secondary to recurrent otitis. Given these antecedents, immunological work and HIV serology were performed. The patient was HIV positive and JC virus was isolated in CSF; CD4T-cell were 99/uL. Brain MRI (figure1) showed signs of progressive multifocal leukoencephalopathy (PML) and HIV encephalitis. It was discovered that the patient was born in our hospital and paper records were recovered. The HIV status of the mother wasn't known until the patient was 2 days old. She started prophylaxis and went HIV negative until 3 months of life, when follow-up was lost. The mother hadn't disclosed her own HIV status to their current primary pediatrician due to stigma. The patient is currently receiving anti-retroviral treatment (ART) and undergoing multidisciplinary follow-up in her city of residency.

Learning Points/Discussion: Prevention of vertical transmission by HIV can be achieved by ensuring correct follow-up and screening in exposed pregnant women and newborns. In patients with recurrent and opportunistic infections, HIV should be ruled out along with primary immunodeficiencies. HIV stigma is still ongoing and can further complicate the care of these patients.

PD008 / #1464

Topic: AS16. Others

PERSISTENT STAPHYLOCOCCAL BACTEREMIA AFFECTING MULTIPLE SYSTEMS IN A BOY WITH SURGICALLY CORRECTED CONGENITAL HEART DISEASE

E-Posters

MEET THE EXPERT POSTERS

Maria Ziaka¹, Charalampos Antachopoulos¹, Krinio Dana¹, Elisavet Michailidou¹, Konstantinos Kollios¹, Emmanuel Roilides²

¹Hippokraton Hospital, 3rd Dept Of Pediatrics, Aristotle University, Thessaloniki, Greece, ²Aristotle University of Thessaloniki, Infectious Diseases Unit, 3rd Pediatric Department, Thessaloniki, Greece

Title of Case: Persistent staphylococcal bacteremia affecting multiple systems in a boy with surgically corrected congenital heart disease

Background: Management of persistent bacteremia in children with surgically corrected congenital cardiopathy remains challenging. The presence of vascular grafts may adversely affect outcome.

Case Presentation Summary: A 9.5-year-old boy, with surgically corrected type-I-truncus arteriosus (and a pulmonary artery graft in place), was referred to our Department with a 3-day fever (>38°C), limp, elevated inflammatory markers, anemia, thrombocytopenia. He was empirically started on IV ceftriaxone, subsequently changed to IV cloxacillin-gentamicin, as for infective endocarditis, due to isolation of methicillin-sensitive *St. aureus* (MSSA) from blood. IV vancomycin was added on day-5, due to patient's lack of clinical improvement and persistently positive blood cultures. During hospitalization the patient developed: Left-knee septic arthritis (ultrasound/MRI-confirmed), with MSSA isolation from synovial fluid. Lung abscesses (HRCT-confirmed) Acute glomerulonephritis (renal function decline, microscopic hematuria, nephrotic-range proteinuria). The condition was initially attributed to drug toxicity. Thus, cloxacillin-gentamicin were discontinued and vancomycin was switched to daptomycin. Due to persistence of inflammation, IV clindamycin and ceftaroline were added on day-11 and day-17 respectively. Renal involvement was ultimately attributed to immune-mediated damage and IV methylprednisolone (2mg/kg/d) was initiated, with gradual resolution of proteinuria and dose tapering. Although the patient fulfilled Duke's criteria for infective endocarditis, endocardial/graft involvement-vegetation was not confirmed by MRI/ultrasound. The patient remained on IV antibiotics for 42 days with slow recovery, and was discharged home on oral cefuroxime for 14 days. Five months afterwards, there are no clinical/laboratory signs of relapse.

Learning Points/Discussion: *S. aureus* bacteremia in children with surgically treated congenital cardiopathy may be complicated by multisystem involvement, requiring a multidisciplinary approach. Immune-mediated nephritis is not unlikely. In the presence of vascular grafts, it may be prudent to follow an endocarditis treatment regimen, even when not confirmed by imaging techniques.

PD009 / #1481

Topic: AS06. Infections in early life / AS06.a. Congenital and perinatal infections

UNEXPECTED CAUSE OF PREMATUREITY – TWO CASES OF CONGENITAL SYPHILIS

E-Posters

MEET THE EXPERT POSTERS

Sofia Baptista, Inês Coelho, Daniel Tiago, Luísa Gaspar, Vera Santos, Marta Soares, João Rosa
Centro Hospitalar Universitário do Algarve, Neonatal Intensive Care Unit, Faro, Portugal

Title of Case: UNEXPECTED CAUSE OF PREMATUREITY – TWO CASES OF CONGENITAL SYPHILIS

Background: Once believed to be a rare disease in developed countries, recent data suggest an increased incidence of congenital syphilis cases. Fetal infection by *treponema pallidum* can result in stillbirth, prematurity and a wide spectrum of clinical manifestations.

Case Presentation Summary: The authors describe two very similar cases of severe congenital syphilis in preterm neonates, both admitted over a 2 month period to the neonatal intensive care unit needing invasive ventilation and intensive care support. At birth, besides severe respiratory distress, they presented with ascites, hepatosplenomegaly and hydrocele. Both babies had severe anaemia and thrombocytopenia, and needing aggressive transfusion support. They also presented with increased inflammatory markers and cholestasis. An investigation was conducted and both neonates had positive treponemal and non-treponemal tests. Both mothers had antenatal positive serology. Other viral and bacterial infections were excluded. Brain ultrasounds were unremarkable. They started early treatment with penicillin and gentamicin. Both babies progressed well and were discharged in good clinical condition after a long stay in the neonatal intensive care unit.

Learning Points/Discussion: Diagnosis of congenital syphilis can be difficult because the majority of infants are asymptomatic at birth. Even when symptomatic, the symptoms are usually non specific or subtle. TORCH infections need always to be considered when facing a severely ill preterm newborn. These two cases are a reminder of the importance of screening and treatment for these infections during pregnancy and at birth.

PD010 / #1579

Topic: AS06. Infections in early life / AS06.a. Congenital and perinatal infections

NEONATAL VARICELLA: FAILURE OF ZOSTER HYPERIMMUNE IGG IN PREVENTION

E-Posters

MEET THE EXPERT POSTERS

Cecilia Pinera^{1,2}, Giannina Izquierdo^{1,2}

¹Hospital Exequiel Gonzalez Cortés, Infectious Disease Unit, San Miguel, Chile, ²Facultad de Medicina Universidad de Chile, Departamento Pediatría Y Cirugía Infantil Sur, San Miguel, Chile

Title of Case: NEONATAL VARICELLA: FAILURE OF ZOSTER HYPERIMMUNE IGG IN PREVENTION

Background: Neonatal varicella occurs if the mother gets the infection around delivery. Infants born to mothers with onset of chickenpox 5 days before to 2 days after delivery are at risk of fatal varicella, and they should receive postexposure prophylaxis with VVZ IgG (ZIG). **OBJECTIVE:** Describe a case of disseminated neonatal varicella despite prophylaxis with ZIG.

Case Presentation Summary: A 38-week term male baby, vaginal delivery, whose mother 3 days prior to delivery developed varicella. The newborn received ZIG at 9 hours of life. He was discharged at 3 days of life, with indication of re-consult in case of symptoms. At 10 days of life, developed erythematous papular lesions on the trunk, without fever. Heat rash was diagnosed and general measures were indicated. The rash persisted and two days later he returned to the emergency department, and was diagnosed with allergic dermatitis. He became increasingly unwell and was admitted later. Examination showed that he was lethargic, with respiratory failure, and shocked. He had an extensive purpuric-vesicular rash. Required immediate circulatory and ventilatory support, and received intravenous acyclovir and broad spectrum antibiotics. He required five days of ventilation and vasoactive drugs. Blood, vesicles and BAL samples demonstrated a positive VVZ PCR. The newborn evolved with myocarditis, hepatitis and varicella pneumonia. He received a total of 10 days of intravenous acyclovir and made a complete recovery. He remained well 20 months



later.

Learning Points/Discussion: Early postexposure prophylaxis with ZIG decreases the risk of VVZ infection, but does not eliminate it. It is important to educate physicians to maintain suspicion and early management if an exposed newborn presents with rash.

PD011 / #1176

Topic: AS07. Non-respiratory infections / AS07.f. Skin Infections

SUBCUTANEOUS DIROFILARIASIS IN A GIRL WITH RHEUMATOID ARTHRITIS

E-Posters

MEET THE EXPERT POSTERS

Maria Kourti^{1,2}, Evangelia-Theofano Piperaki³, Eleni Papadimitriou⁴, Maria Trachana⁴, Evaggelia Farmaki⁴, Emmanuel Roilides^{1,2}

¹Aristotle University of Thessaloniki, Third Department Of Pediatrics, Thessaloniki, Greece, ²Aristotle University of Thessaloniki, Infectious Diseases Unit, Thessaloniki, Greece, ³National and Kapodistrian University of Athens, Department Of Microbiology, medical School, Athens, Greece, ⁴Aristotle University of Thessaloniki, 1st Department Of Pediatrics, Thessaloniki, Greece

Title of Case: SUBCUTANEOUS DIROFILARIASIS IN A GIRL WITH RHEUMATOID ARTHRITIS

Background: Human subcutaneous dirofilariasis is a rare helminthic infection, caused by filarial worms *Dirofilaria* species

Case Presentation Summary: A 9-year-old girl with a history of juvenile rheumatoid arthritis with enthesitis treated with adalimumab presented with a subcutaneous nodule on the forehead with a 2-month duration. The nodule was non-tender and mobile with a 1.5 cm in diameter. The systemic examination was unremarkable. Magnetic Resonance Imaging (MRI) brain scan was normal. Further laboratory findings showed normal blood counts, normal IgE, and no eosinophilia. Clinical differential diagnosis is very broad and includes rheumatoid nodule, dermoid cyst, lipoma, hemangioma, lymphangioma, osteoma, epithelioid sarcoma, infectious granuloma, and deep granuloma annulare. Excision of the subcutaneous lesion was decided upon the clinical implication of a malignant tumor. Histology showed a nodule with a mixed inflammatory response involving lymphocytes and eosinophils around the lesion's centre, with fragments of a *Dirofilaria repens* female worm. Under the microscope, cross sections of the female worm are depicted. The worm is covered by a thick multilayered cuticle with longitudinal ridges on the outer surface. This is the main feature that differentiates this parasite from adult *Onchocerca* worm. The adult female's uteri contain only ova, as the worm does not reach maturity in humans and microfilariae are not produced. On the basis of microscopic and pathology examination, worm was thus identified as *Dirofilaria repens*. Excision of the subcutaneous lesion is both diagnostic and therapeutic.

Learning Points/Discussion: This case emphasizes that human subcutaneous dirofilariasis should be considered in the differential diagnosis of a single subcutaneous nodule, especially, when the patient is coming from an endemic area. The clinical implication of human dirofilariasis is that, this subcutaneous lesion may be initially misidentified before the correct diagnosis is made.

PD012 / #851

Topic: AS13. COVID 19 and MIS-C

SARS-COV-2 ASSOCIATED MENINGOENCEPHALITIS IN A CHILD

E-Posters

MEET THE EXPERT POSTERS

Wanyun Lin¹, Audrey Lee¹, [Rie Aoyama](#)¹, Olivia Leow¹, Furene Wang^{1,2}, Wen Yi Thong^{1,2}, Si Min Chan^{1,2}
¹National University Health System, Singapore, Khoo Teck Puat-national University Children's Medical Institute, Singapore, Singapore, ²National University Singapore Yong Loo Lin School of Medicine, Singapore, Department Of Paediatrics, Singapore, Singapore

Title of Case: SARS-CoV-2 associated meningoencephalitis in a child

Background: Neurological complications of SARS-CoV-2 infection are rarely reported and not well characterized.

Case Presentation Summary: We report a 6-year old healthy Indian girl with 3 days of mild febrile upper respiratory tract infection due to coronavirus disease-2019 (COVID-19) confirmed by positive nasopharyngeal PCR swab; cycle threshold (Ct) 21.4. On day 7 of infection, she developed saddleback fever with gastrointestinal symptoms, lethargy and reduced oral intake, then subsequent meningoencephalitis on day 14 with irritability, neck stiffness, and altered mental state. Examination showed upper motor neuron signs, globally reduced power, and positive Kernig's/Brudzinski's signs. There were no features suggestive of Multisystem Inflammatory Syndrome in Children (MIS-C). Investigations revealed mildly elevated blood inflammatory markers and significant cerebrospinal fluid (CSF) lymphocytic pleocytosis. SARS-CoV-2 PCR Ct 36.6; anti-spike and anti-N capsid antibody positive. Extensive investigations for bacterial and viral pathogens including CSF SARS-CoV-2, blood and CSF autoimmune encephalopathy panels, and serum anti-NMDA-R antibody were negative. Magnetic resonance imaging of the brain showed slightly hyperintense bulky thalami with subtle deep grey matter involvement. She received 5 days of intravenous immunoglobulin (IVIG) on day 18 of infection; fever and meningism resolved. She required ongoing rehabilitation for significant speech, motor, coordination, cognitive, and attention deficits.

Learning Points/Discussion: Meningoencephalitis in COVID-19 is rare, mostly occurs in severe COVID-19/MIS-C, and is associated with poorer outcomes and higher mortality. Proposed mechanisms are 1) direct viral invasion of the nervous system, 2) molecular mimicry causing a post-infectious immune-mediated response, or 3) indirect cytokine-driven injury due to systemic inflammation. Risk factors, CSF/neuroimaging findings, optimal management and prognosis, are poorly understood. Our patient's clinical course suggests an immune-mediated meningoencephalitis triggered by SARS-CoV-2, which responded well to IVIG although long-term sequelae are still unknown.

PD013 / #1553

Topic: AS07. Non-respiratory infections / AS07.e. Skeletal infections

HAEMOPHILUS INFLUENZAE SEROTYPE A SEPTIC ARTHRITIS – AN EMERGING ENTITY

E-Posters

MEET THE EXPERT POSTERS

Inês Pedrosa¹, Joana Freitas², Ana Reis E Melo³, Margarida Tavares³

¹Centro Hospitalar de Leiria, Paediatrics, Leiria, Portugal, ²Centro Hospitalar Universitário de São João, Department Of Orthopaedics And Traumatology, Porto, Portugal, ³Centro Hospitalar Universitário de São João, Paediatrics Infectious Diseases And Immunodeficiencies, Porto, Portugal

Title of Case: HAEMOPHILUS INFLUENZAE SEROTYPE A SEPTIC ARTHRITIS – AN EMERGING ENTITY

Background: Septic arthritis (SA) is a serious infection, usually affecting large joints such as the knee and hip, most commonly in children under 2 years and typically due to hematogenous spread. In the post-vaccine era, with the decline of type b invasive infections, there has been a rebound in the incidence of infections caused by other strains of Haemophilus influenzae, particularly serotype a.

Case Presentation Summary: A 17 month-old boy was admitted in the emergency department for a 2-day history of right side claudication, hip pain, refusal to bear weight and fever. Additionally, productive cough and nasal congestion were noted. Objectively, he was lethargic, with right hip flexing position and pain to mobilization. Blood panel showed hemoglobin 11.4g/dL, leukocytes 16290/uL, ESR 65mm/h and CRP 6.7mg/dL. Hip x-ray was normal but a 4mm synovial effusion was noted on ultrasound. Blood cultures were drawn before empiric cefuroxime was started as the clinical suspicion for septic arthritis was high. Blood cultures were positive for H. influenzae type a (Hia), sensitive to cefuroxime. As the patient failed to improve initially, a hip MRI was ordered and showed moderated volume synovial effusion, with synovial and peri-articular inflammation. Diagnostic percutaneous drainage of fluid was performed and was positive for Hia DNA. The patient gradually improved and at discharge still had mild claudication but was able to walk unassisted. He completed a 3-week antibiotic course (1-week oral therapy).

Learning Points/Discussion: This rare case of SA due to Hia in a 17-month-old immunocompetent child, up to date with the national vaccination program and with no relevant medical history, underlines the importance of serotyping H. influenzae in pediatric patients to document the etiologic changes and improve clinical management.

PD014 / #1328

Topic: AS06. Infections in early life / AS06.b. Neonatal sepsis

EARLY-ONSET NEONATAL PNEUMOCOCCAL SEPSIS: AN OLD BUT SOMETIMES FORGOTTEN PATHOGEN

E-Posters

MEET THE EXPERT POSTERS

Inês Coelho¹, Sofia Baptista¹, Luísa Gaspar², Cláudia Calado², Maria Virtuoso¹, João Rosa²

¹Centro Hospitalar Universitário do Algarve, Paediatrics, Faro, Portugal, ²Centro Hospitalar Universitário do Algarve, Neonatal Intensive Care Unit, Faro, Portugal

Title of Case: Early-Onset Neonatal Pneumococcal Sepsis: an old but sometimes forgotten pathogen

Background: Streptococcus pneumoniae (SP) is an uncommon but potentially serious neonatal pathogen. SP is recognized as an important cause of morbidity and mortality in childhood, but there are rather few reported cases of neonatal sepsis, with incidences described between 1% and 11%. We aim to report the spectrum of morbidity associated with SP infections in the neonatal period.

Case Presentation Summary: Two cases of neonatal SP infection are reported. The first neonate presented with very early onset of severe clinical disease with bacteremia and pneumonia. She developed severe pulmonary hypertension and needed intensive ventilatory and vasoactive support including nitric oxide. A SP serotype 23B was isolated from blood cultures and bronchial secretions as well as from the mother's vaginal secretions. In the second case, the baby presented with bacteremia and meningitis. He remained hemodynamically stable and had no need for respiratory support. The blood and cerebrospinal fluid cultures revealed a SP serotype 8. In both cases, the neonates started antibiotic therapy with vancomycin and cefotaxime. Since both strains showed susceptibility to ampicillin and cefotaxime, vancomycin was withdrawn during hospitalization. Both mothers remained well and asymptomatic during the perinatal period.

Learning Points/Discussion: These reported cases emphasize the importance of considering a wide range of microorganisms in the differential diagnosis of early-onset neonatal sepsis. Although uncommon, SP can have different clinical manifestations and cause significant disease in newborns. In the absence of sufficient scientific evidence to implement specific preventive measures against early-onset sepsis for this agent, early and aggressive treatment remains the best therapeutic option.

PD015 / #1061

Topic: AS06. Infections in early life / AS06.a. Congenital and perinatal infections

THE SEQUELAE OF CONGENITAL TOXOPLASMOSIS – HOW FREQUENT? HOW SEVERE?

E-Posters

MEET THE EXPERT POSTERS

Daniela Vivacqua, Thalita Abreu, Ana Cristina Frota, [Cristina Hofer](#)
Universidade Federal do Rio de Janeiro, Infectious Diseases, Rio de Janeiro, Brazil

Title of Case: The sequelae of congenital toxoplasmosis – How frequent? How severe?

Background: Congenital toxoplasmosis (CT) is the main preventable congenital infection in Brazil, however, it can lead to severe sequelae. This manuscript aims to quantify and describe sequelae of CT .

Case Presentation Summary: Methods: This is a case series study, with data collected from medical records, from infants admitted under one year of age at the Infectious Diseases Clinic of Instituto de Puericultura e Pediatria Martagão Gesteira, reference center from Rio de Janeiro, exposed to toxoplasmosis during their antenatal period. Patients diagnosed with CT were studied and described. The children were followed up for at least one year (during this year they receive sulfadiazine, pyrimethamine, and folinic acid), afterwards the sequelae were evaluated through CNS image exam and ophthalmology evaluation. Results: A total of 289 patients were followed up in 10 years. CT was confirmed in 43 (14.9%) of which 37 (86%) presented sequelae at the end of follow up. 33 patients presented scars at fundoscopy (19 on macular area) and 24 with Central nervous system (CNS) manifestations (9 hydrocephalus, 18 CNS calcifications, 6 epilepsy, 8 microcephaly), and one child died during the follow up.

Learning Points/Discussion: Among the children with CT, the sequelae are common and severe. Most of the children with CT developed sequelae even after one year of treatment. Interventions to prevent the CT must be pursued.

PD016 / #1207

Topic: AS05. Global health / AS05.b. Tropical/parasite infections & travel medicine

SEVERE MALARIA IN A CHILD COMPLICATED BY SECONDARY HEMOPHAGOCYTIC LYMPHOHISTIOCYTOSIS

E-Posters

MEET THE EXPERT POSTERS

Anna Hermine Markowich¹, Martina Di Giuseppe¹, Stefania Mercadante¹, Sara Chiurchiù¹, Lorenza Romani¹, Andrzej Krzysztofiak¹, Stefania Bernardi¹, Laura Cursi¹, Paolo Palma², Laura Lancella¹

¹Bambino Gesù Children's Hospital, IRCCS, Immunology And Infectious Diseases Unit, Rome, Italy, ²Bambino Gesù Children's Hospital, Clinical Immunology And Vaccinology, Rome, Italy

Title of Case: Severe malaria in a child complicated by secondary hemophagocytic lymphohistiocytosis

Background: Severe malaria is defined as high parasitemia associated with clinical and laboratory signs of organ damage. It is usually caused by *Plasmodium falciparum* infection and children are more at risk than adults. We report a child with severe malaria infection and secondary hemophagocytic lymphohistiocytosis (HLH) who was successfully treated.

Case Presentation Summary: A 13-year-old boy from Mali presented to the emergency department with fever for the past 5 days. One week before he had returned to Italy from Mali. On physical examination he was unwell, jaundiced and an enlarged spleen was noted. His blood exams showed slight anemia (Hb 11 g/dl), thrombocytopenia (PLTs 25.000/mcl), hyperbilirubinemia (12 mg/dl), increase in transaminases (GOT 400 U/l, GPT 250 U/l) and C-reactive protein (CRP 180 mg/l). Molecular test for *P. falciparum* was positive on blood, with a parasitemia of 18%. The patient met the diagnostic criteria for severe malaria and treatment with intravenous artesunate was immediately started. Despite appropriate treatment and reduction of parasitemia to 2%, the patient remained febrile, with worsening anemia and increase of inflammatory markers, including ferritin and triglycerides, therefore secondary HLH was diagnosed. High-dose intravenous corticosteroids were administered, with prompt improvement of the overall clinical state and biochemical markers. Following stabilization, corticosteroids were progressively tapered and antiparasitic therapy was switched to oral artemether and lumefantrine, which was discontinued after one week.

Learning Points/Discussion: In conclusion, it is important to consider malaria in all febrile patients with history of travel to malarious areas. Severe malaria can be associated with poor outcome. Secondary HLH must be ruled out in children with poor response to anti-malaric treatment, early diagnosis and appropriate treatment can prevent complications and can be life-saving.

PD017 / #536

Topic: AS05. Global health / AS05.b. Tropical/parasite infections & travel medicine

IMPORTED CHILDHOOD MALARIA IN LONDON: A RETROSPECTIVE ANALYSIS OF CLINICAL AUDIT DATA FROM NINE NHS HOSPITALS (2019-2020)

E-Posters

VIRTUAL POSTER DISCUSSION SESSION

Stefan Ebmeier¹, Aula Abbara², Frances Davies², Mark Gilchrist², Anna Goodman³, Laurence John⁴, John Klein³, Nabeela Mughal⁵, Geraldine O'Hara³, Padmasayee Papineni⁴, Shiranee Sriskandan², Ashley Whittington⁴, Aubrey Cunnington^{6,7}

¹Imperial College London, Paediatric Infectious Diseases, London, United Kingdom, ²Imperial College Healthcare NHS Trust, Infectious Diseases, London, United Kingdom, ³Guy's and St Thomas' NHS Foundation Trust, Infectious Diseases, London, United Kingdom, ⁴London North West University Healthcare NHS Trust, Infectious Diseases, London, United Kingdom, ⁵Chelsea and Westminster Hospital NHS Foundation Trust, Infectious Diseases, London, United Kingdom, ⁶Imperial College London, Infectious Diseases, London, United Kingdom, ⁷Imperial College Healthcare NHS Trust, Paediatric Infectious Diseases, London, United Kingdom

Backgrounds: Background Malaria is a tropical mosquito-borne infection caused by Plasmodium parasites. Prompt diagnosis and treatment are essential to prevent development of severe disease and death. The UK is estimated to have the most imported malaria cases of any non-endemic country, other than France. In 2010-2019 in the UK, there were on average >1600 reported cases per year (about 10% in children)

Methods: A retrospective clinical audit was undertaken at nine London NHS hospitals (2019-2020). Patients with a positive blood film were included; those transferred from external hospitals were excluded. The primary outcome was time from presentation to first antimalarial dose. Secondary outcomes included reasons for treatment delay and degree of compliance with local guidelines. Comparisons were made between children (0-15 years) and adults (≥16 years).

Results: Results Only 17/215 patients were children, of whom three had severe malaria, and none died (Table 1). Median time from presentation to first antimalarial dose was 7.7 and 6.2 hours in children and adults respectively (p=0.347). Median time from presentation to malaria screen request was 2.0 and 0.8 hours in children and adults respectively (p<0.001). Reported reasons for treatment delay in children included awaiting transfer to ward, patient discharged before blood film reported, and awaiting antimalarial medicines from

Table 1. Selected results from malaria audit at nine London NHS hospitals (2019-2020).

Categorical data are presented as n (%) with Fisher's exact test. Continuous data are presented as median (IQR) with Wilcoxon-Mann-Whitney test. Numbers in bold represent the n with available data for each category. SM severe malaria, NHS National Health Service, WHO World Health Organisation, ED emergency department.

| | 0-15 years | ≥16 years | p-value |
|--|-------------------------|--------------------------|----------------|
| Sex | 17 | 198 | |
| Female | 7 (41) | 74 (37) | p=0.797 |
| Plasmodium species | 17 | 198 | |
| <i>P. falciparum</i> (including mixed infection) | 15 (88) | 169 (85) | p=1.000 |
| Region of travel | 17 | 194 | |
| Sub-Saharan Africa | 17 (100) | 185 (95) | p=1.000 |
| Nigeria | 11 (65) | 58 (30) | p=0.006 |
| Usual country of residence | 17 | 185 | |
| Outside UK | 8 (47) | 22 (12) | p<0.001 |
| Chemoprophylaxis | 7 | 136 | |
| None taken | 2 (29) | 86 (63) | p=0.107 |
| Clinical severity | 17 | 198 | |
| SM by NHS hospital criteria | 6 (35) | 68 (34) | p=1.000 |
| SM by WHO criteria | 3 (18) | 17 (9) | p=0.200 |
| Intensive care | 1 (6) | 10 (5) | p=0.605 |
| Died | 0 (0) | 1 (1) | p=1.000 |
| Management time intervals (hours) | | | |
| Presentation to first antimalarial dose | 7.7 (6.0-8.8) [n=14] | 6.2 (4.9-8.6) [n=127] | p=0.347 |
| Presentation to malaria screen request | 2.0 (1.5-2.5) [n=16] | 0.8 (0.4-1.5) [n=175] | p<0.001 |
| Malaria screen request to sample in lab | 0.8 (0.4-1.4) [n=17] | 0.7 (0.3-1.2) [n=181] | p=0.378 |
| Sample in lab to antimalarial prescription | 3.1 (2.0-3.9) [n=12] | 3.1 (2.1-4.8) [n=117] | p=0.820 |
| Antimalarial prescription to first dose | 1.4 (0.3-2.0) [n=10] | 1.5 (0.8-2.4) [n=110] | p=0.382 |
| Reported reasons for treatment delay | 17 | 198 | |
| Any treatment delay (presentation to first antimalarial dose >8 hours) | 5 (29) | 36 (18) | p=0.330 |
| Awaiting transfer to ward | 2 (12) | 0 (0) | p=0.006 |
| Antimalarial medicine not immediately available | 1 (6) | 14 (7) | p=1.000 |
| Patient discharged before blood film reported | 1 (6) | 4 (2) | p=0.340 |
| Awaiting assessment in ED | 0 (0) | 12 (6) | p=0.605 |
| Low initial clinical suspicion | 0 (0) | 11 (6) | p=1.000 |

pharmacy.

Conclusions/Learning Points: Discussion Median time from presentation to malaria screen request was 1.2 hours longer for children as compared to adults. However, there was no statistical difference in time from presentation to first antimalarial dose (possibly due to missing data for adults managed as outpatients). Some treatment delays in children may be prevented by starting antimalarial therapy before transfer to the ward, keeping the child in hospital until blood film is reported, and ensuring accessibility of antimalarial medication.

PD018 / #790

Topic: AS08. Respiratory infections (only non-SARS-CoV2 content) / AS08.a. Viral respiratory infections

RESPIRATORY SYNCYTIAL VIRUS (RSV): THE 2021 EPIDEMIC

E-Posters

VIRTUAL POSTER DISCUSSION SESSION

Ana Rita Fradique¹, Mariana Sebastião¹, Ana Teresa Gil¹, Lia Gata¹, Lurdes Correia², Fernanda Rodrigues^{1,3}

¹Hospital Pediátrico, Centro Hospitalar e Universitário de Coimbra, Infectious Diseases Unit And Emergency Service, Coimbra, Portugal, ²Centro Hospitalar e Universitário de Coimbra, Clinical Pathology Service, Coimbra, Portugal, ³University of Coimbra, Faculty Of Medicine, Coimbra, Portugal

Backgrounds: RSV circulation was profoundly affected by the COVID-19 pandemic. The aim is to describe RSV detection in a tertiary pediatric hospital in central Portugal during this period and comparing it with previous seasons.

Methods: Retrospective analysis of all children with acute respiratory infection observed in an Emergency Service with RSV detection by PCR in nasopharyngeal samples as part of routine care, from April 2015 to December 2021. An epidemic year was defined from the April 1 to March 31 of the following year.

Results: RSV was detected in 2662 samples. In the pre-COVID-19 era, epidemics started in November/December and peaked in December/January. Acute bronchiolitis was the most frequent diagnosis, with a median age of 8M. In 2020/21 there were no cases of RSV infection. In 2021/22 the epidemic started in May, peaking in August/September (figure) with the most frequent diagnosis being nasopharyngitis, with a median age of 21M. Admitted patients (staying ≥ 24 h) in the current epidemic compared to the pre-COVID-19 epidemics, showed a mean age of 18M vs 12M, with a bronchiolitis diagnosis in 58 % vs 74% ($p < 0,05$), oxygen requirement in 52% vs 69% ($p < 0,05$), chest X-ray performed in 49% vs 56% ($p = 0,17$), lab tests ordered in 41% vs 54% ($p = 0,01$), antibiotic use in 29% vs 28% ($p = 0,805$), intensive care admission in 4% vs 11% ($p = 0,02$) and mean duration of admission of 4 vs 7 days ($p < 0,01$).

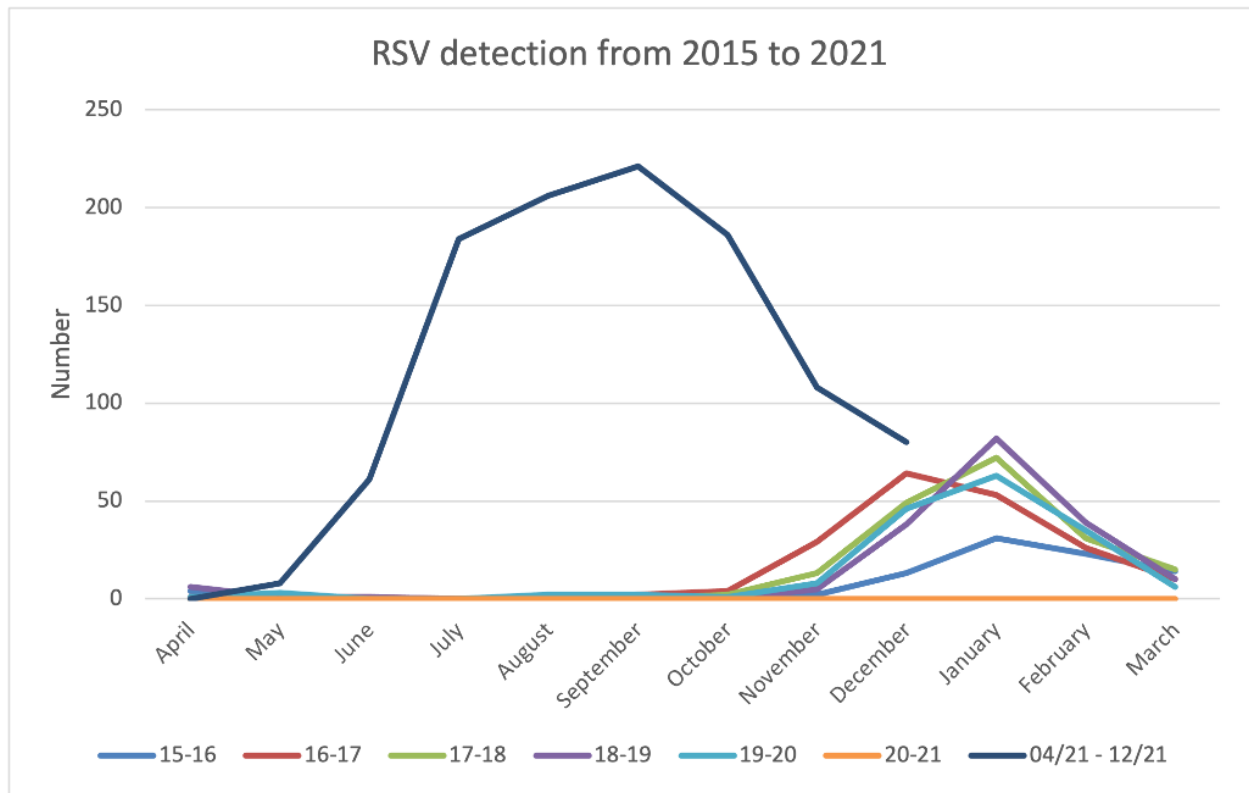

Conclusions/Learning Points: In 2021 we observed a big epidemic outside its usual period, with older children, predominantly with rhinopharyngitis, which may have been influenced by different testing criteria during the COVID-19 pandemic. Admitted patients had less supplemental oxygen requirement, less admission to intensive care and shorter duration of admission, which suggest a less severe disease.

PD019 / #1010

Topic: AS08. Respiratory infections (only non-SARS-CoV2 content) / AS08.a. Viral respiratory infections

CHANGES IN OTHER RESPIRATORY VIRUS ACTIVITY DURING THE COVID-19 PANDEMIC

E-Posters

VIRTUAL POSTER DISCUSSION SESSION

Miguel Lucas¹, Mariana Costa¹, Ana Teresa Gil¹, Lia Gata¹, Fernanda Rodrigues^{1,2}

¹Hospital Pediátrico, Centro Hospitalar e Universitário de Coimbra, Portugal, Infectious Diseases Unit And Emergency Service, Coimbra, Portugal, ²University of Coimbra, Faculty Of Medicine, Coimbra, Portugal

Backgrounds: The COVID-19 pandemic led to the implementation of non-pharmacological interventions to decrease respiratory viruses' transmission. The aim of this study is to describe the impact of these interventions in activity of other common paediatric respiratory viruses during this period.

Methods: Retrospective analysis of the respiratory viruses detected by PCR in nasopharyngeal samples (FilmArray respiratory panel), from children with acute respiratory infections as part of routine care, in an emergency service (ES) of a paediatric tertiary hospital, from January 2015 to June 2021.

Results: Over the years, we observed an increasing number of samples submitted to PCR and increasing proportion of positive tests until 2020-21 when both have dramatically decreased after the onset of the pandemic. During the first 15 months of the pandemic, there was a marked reduction in all the other respiratory viruses, with: no detection of Influenza Virus (IV; subtypes H1N1, H3, and IB); detection of one case of Human Metapneumovirus (HMPV) in September 2020; historic low circulation for Respiratory Syncytial Virus (RSV) until late May/early June 2021 when a big epidemic started. For Rhino/Enteroviruses (RV/EV) and Adenovirus (AdV), despite decreased activity, there was a maintained detection, that increased after April 2021 (Figure1). FIGURE1. Number of specimens tested and number of detected influenza viruses (IF), respiratory syncytial virus (RSV), human coronaviruses (HCoV), parainfluenza viruses (PI), human metapneumovirus (HMP), respiratory adenoviruses (AdV), rhinoviruses/enteroviruses (RV/EV), 2015-2021.

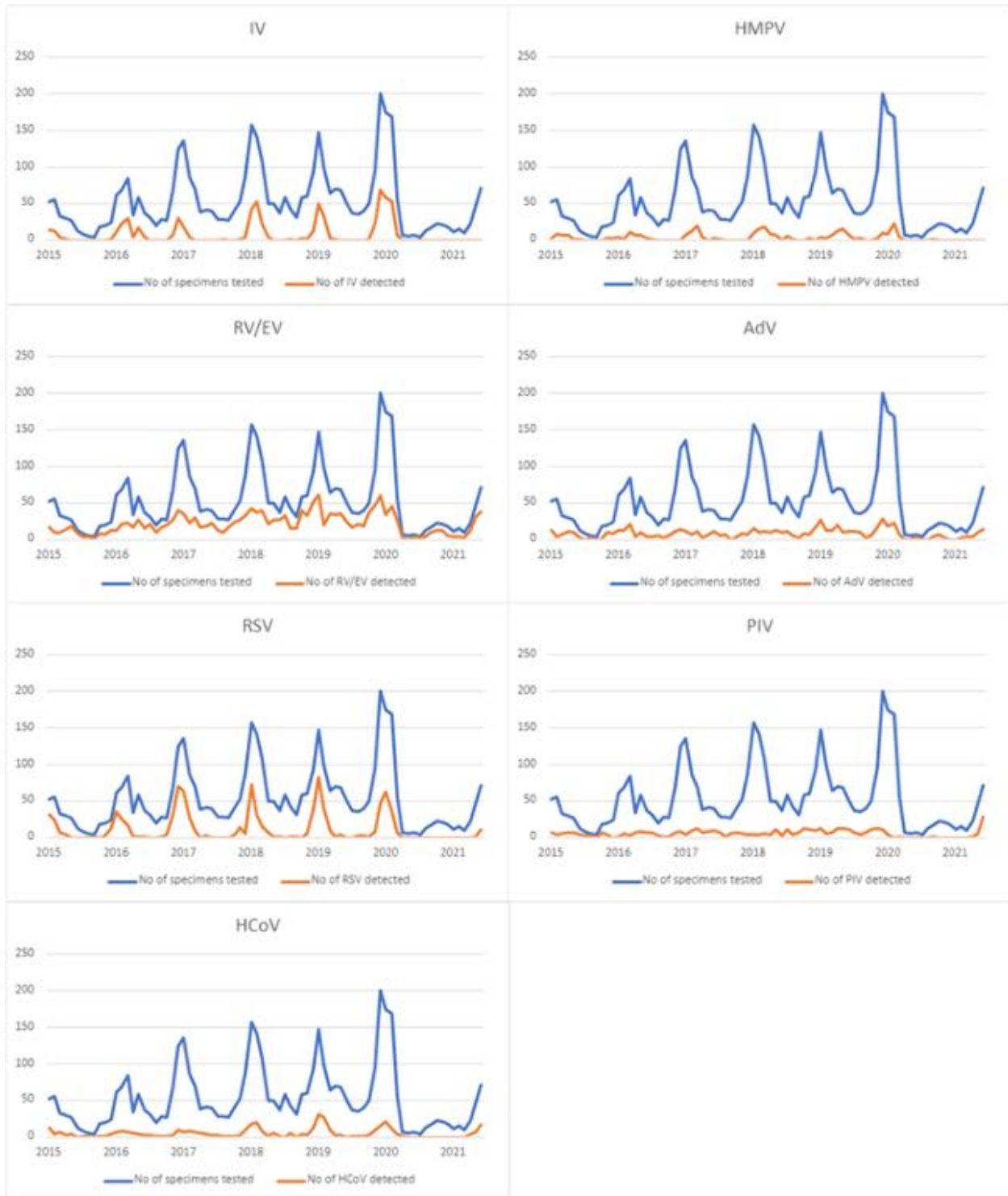

Conclusions/Learning Points: In conclusion, in the first year of COVID-19 pandemic we observed changes in other respiratory viruses' detection, although with differences between them, most notably a dramatic decrease for IV, RSV, parainfluenza and HMPV, remaining some detection of RV/EV and AdV. After May-June 2021, we started observing a resurgence except for IV and HMPV that remained undetectable.

PD020 / #320

Topic: AS03. Vaccines (only non SARS-CoV2 content) / AS03.c. Vaccine efficacy (phase 3) and effectiveness – viral

FOCUS ON ADOLESCENT IMMUNISATIONS: CONCOMITANT ADMINISTRATION OF MENACWY-CRM, TDAP AND HPV VACCINES. INTEGRATED RESULTS FROM A PHASE 4, RANDOMISED, OBSERVER-BLIND, CONTROLLED CLINICAL STUDY

E-Posters

VIRTUAL POSTER DISCUSSION SESSION

Maria Lattanzi¹, Marco Costantini², Thembile Mzolo³, Michele Pellegrini¹

¹GSK VACCINES SRL, Global Clinical Research And Development, SIENA, Italy, ²GSK Vaccines, Biostatistics And Statistical Programming, Siena, Italy, ³GSK Vaccines, Biostatistics, Amsterdam, Netherlands

Backgrounds: Concomitant administration of meningococcal (Men), tetanus, diphtheria, pertussis (Tdap) and human papillomavirus (HPV) vaccines could increase compliance to adolescents' immunization schedules.

Methods: A phase 4 study of 801 healthy participants aged 11–18 years investigated the immunogenicity and safety of a quadrivalent Men conjugate vaccine (MenACWY-CRM) co-administered with Tdap and quadrivalent HPV (HPV-4) vaccines (NCT01424644). Participants were randomised (1:1) to receive either MenACWY-CRM (MenACWY group) or placebo (placebo group), co-administered with Tdap and HPV4, with two additional HPV4 doses, 2 and 6 months after the first. Antibody responses to Men A, C, W and Y serogroups, Tdap antigens and HPV-6, -11, -16 and -18 were assessed at baseline and one month post-vaccination. Safety was monitored throughout the study.

Results: At one month post-vaccination, 77%, 84%, 95% and 86% of participants in the MenACWY group achieved human complement serum bactericidal activity titres ≥ 8 against Men A, C, W and Y, respectively, and 95% and 99% had seroprotective antibody levels (≥ 1.0 IU/mL) against diphtheria and tetanus toxoids, respectively, compared with 82% and 98% in the placebo group. Seroconversion rates against HPV types ranged between 98.0% (HPV-6) and 99.7% (HPV-11 and HPV-18) for participants in the MenACWY group and between 99.0% (HPV-11 and HPV-16) and 99.7% (HPV-6 and HPV-18) in the placebo group. Predetermined non-inferiority criteria for immunological responses against all Tdap antigens and HPV types were met, thus fulfilling the co-primary study endpoints. No safety concerns with co-administration of the three vaccines were identified.

Conclusions/Learning Points: Integrated results from this phase 4 study support concomitant administration of MenACWY-CRM, Tdap and HPV-4 vaccines as an immunisation practice for adolescents. Funding: GlaxoSmithKline Biologicals SA. Acknowledgements: Business & Decision Life Sciences (Coordinator: Julien Doornaert).

PD021 / #589

Topic: AS02. Public health and epidemiology (only non SARS-CoV2 content) / AS02.b. Modelling studies

INFANT PNEUMOCOCCAL CONJUGATE VACCINE PROGRAMS RESULT IN SUBSTANTIAL COST-SAVINGS AND CASES AVERTED IN THE UNITED KINGDOM

E-Posters

VIRTUAL POSTER DISCUSSION SESSION

Boglarka Mikudina¹, Andrew Vyse², Carole Czudek², Gillian Ellsbury², Johnna Perdrizet³, Matt Wasserman³, Cheryl Mcdade⁴, Mickey Wilson⁴

¹Pfizer UK Ltd, Health And Value, Walton Oaks, United Kingdom, ²Pfizer UK Ltd, Medical And Scientific Affairs, Walton Oaks, United Kingdom, ³Pfizer Inc, Global Health Economics And Outcomes Research, New York City, United States of America, ⁴RTI Health Solutions, Health Economics And Outcomes Research, Research Triangle Park, United States of America

Backgrounds: The UK introduced the infant 7-valent pneumococcal conjugate vaccine (PCV7) in 2006 and replaced it with the 13-valent (PCV13) in 2010. A decision-analytic model was developed to estimate the historical clinical and economic impact of UK PCV national programs between 2006 and 2018 under a 2+1 schedule.

Methods: Historical incidence of invasive pneumococcal disease (IPD), outpatient pneumonia, and otitis media (OM) were obtained from epidemiologic databases supplemented with published and unpublished data. Event costs were from National Health Service Reference Costs 2015-2016, vaccine costs from the British National Formulary, and utility weights from published sources. Two scenarios were considered: (1) the observed historical incidence from 2006-2018 in the setting of PCV use; and (2) a hypothetical scenario in which we estimated the number of disease cases assuming no PCV use. Averted cases, deaths, incremental costs, and quality-adjusted life years (QALYs) were obtained by subtracting the vaccine scenario totals from the no-vaccine scenario totals.

Results: Together PCV7 and PCV13 programs were estimated to have saved 79,712 lives and averted 50,993 IPD cases, 530,271 inpatient pneumonia episodes, and 921,133 OM episodes in the UK from 2006-2018 (Figure 1). This reduction in disease cases produced total cost savings of £681,763,795 and 79,027 QALYs gained over the period. Vaccination costs were more than offset by the direct medical cost savings from fewer cases of IPD, inpatient pneumonia, and OM.

Figure 1. Historical impact of the infant pneumococcal conjugate vaccine national programs under a 2+1 schedule in the United Kingdom

| Results | With infant PCV Programs | Without infant PCV Programs | Incremental |
|---|-------------------------------------|-----------------------------|-----------------|
| Outcomes | | | |
| Cases of: | | | |
| Bacteremia | 105,885 | 150,969 | -45,084 |
| Meningitis | 11,765 | 16,774 | -5,009 |
| Inpatient pneumonia | 1,900,528 | 2,430,799 | -530,271 |
| Mild otitis media | 4,283,882 | 5,152,221 | -868,340 |
| Moderate/severe otitis media | 203,004 | 255,796 | -52,793 |
| Total pneumococcal disease cases | 6,505,064 | 8,006,559 | -1,501,497 |
| Deaths | 202,048 | 281,760 | -79,712 |
| Total life years | 1,059,971,016 | 1,059,887,463 | 83,553 |
| Total QALYs | 929,426,051 | 929,347,024 | 79,027 |
| Costs | | | |
| Vaccine-related costs | £1,349,975,753 | £0 | £1,349,975,753 |
| IPD costs | £437,350,904 | £616,165,102 | -£178,814,198 |
| Pneumonia costs | £6,423,585,251 | £8,191,767,954 | -£1,768,182,703 |
| Otitis media costs | £376,883,268 | £461,625,915 | -£84,742,647 |
| Total costs | £8,587,795,175 | £9,269,558,970 | -£681,763,795 |
| ICER | PCV programs dominant (cost-saving) | | |
| Abbreviations: ICER = incremental cost-effectiveness ratio; IPD = invasive pneumococcal disease; PCV = pneumococcal conjugate vaccine; QALY = quality-adjusted life year. | | | |

Conclusions/Learning Points: Infant PCV programs in the UK have provided significant health benefits and resulted in a substantial cost-savings under a 2+1 schedule at list price. These findings highlight that PCVs have exceeded many expectations by preventing substantial disease burden and saving disease-related cost.

PD022 / #348

Topic: AS11. Diagnostics and biomarkers

VALUE OF PROCALCITONIN AND C-REACTIVE PROTEIN DURING SYSTEMIC INFLAMMATORY RESPONSE SYNDROME: DIFFERENTIAL DIAGNOSIS UTILITY

E-Posters

VIRTUAL POSTER DISCUSSION SESSION

Yulia Dinikina, Yulia Toshina, Anna Smirnova, Svetlana Lapaeva, Margarita Belogurova
Almazov National Medical Research Centre, Department Of Paediatric Oncology And Bmt, Saint-Petersburg, Russian Federation

Backgrounds: There is still some debate concerning the problem of differential diagnosis between etiology of infections in pediatric patients with oncological diseases. PCT and CRP could be helpful for optimization of antimicrobial therapy and better infection control evaluation.

Methods: Retrospective analysis of 125 episodes of fever during neutropenia in 70 pediatric with solid tumor (52,8%) or hemoblastosis (47,2%) was made. Laboratory diagnostics included microscopy, cultural, serological analysis of body fluids and visualizing diagnostics. CRP and PCT levels were measured in onset of fever, on 1-2 day after initiation of antimicrobial therapy. Two groups were identified: 1 group - nonbacterial infection/ other etiology of fever (n=54) and 2 group - verified bacterial infection (n=70). The 2nd group was subdivided into severe bacterial infection and non-severe according clinical data, ICU hospitalization, outcome.

Results: The median CRP and PCT in groups 1 and 2 were 157.0 g/l vs 159.7 g/l ($p=0.67$) and 0.4 ng/ml vs 1.47 ng/ml ($p=0.000$) respectively. The area under the ROC curves for CRP and PCT differed significantly ($p=0.004$) that indicates the higher values of PCT in diagnosing bacterial infection. In groups of severe and non-severe bacterial infections the values of CRP also had no significant difference – 162.3 ng/ml vs 152.3 ng/ml ($p=0.121$), but for PCT we revealed positive significant correlation (2.7 ng/ml vs 0.23 ng/ml, $p=0.000$). We noted more rapid (1-2 day after antibacterial therapy was started) and significant decrease of PCT (0.68 vs 0.5, $p=0.011$) compared to CRP (159.9 vs 145.3, $p=0.7$) in case of infection control achievement.

Conclusions/Learning Points: We consider that usage of PCT can be helpful for earlier diagnostic of infections, differential diagnosis of etiology of fever, better control of response to antimicrobial therapy and prevention of inappropriate antibiotic usage.

PD023 / #1415

Topic: AS02. Public health and epidemiology (only non SARS-CoV2 content) / AS02.b. Modelling studies

GESTATIONAL SYPHILIS IN MALAWI BETWEEN 2014-2020: SPATIO-TEMPORAL MODELLING OF INDIVIDUAL- AND POPULATION-LEVEL FACTORS.

E-Posters

VIRTUAL POSTER DISCUSSION SESSION

James Chirombo¹, Annelisa Majamanda², Simeon Yosefe³, Washington Ozituosauka⁴, Effie Chipeta⁵, Peter Macpherson^{6,7}, Bridget Freyne^{8,9}

¹Malawi-Liverpool-Wellcome Programme, Statistical Support Unit, Blantyre, Malawi, ²Ministry of Health, Blantyre District Health Office, Blantyre, Malawi, ³Ministry of Health, Digital Health, Lilongwe, Malawi, ⁴Ministry of Health, Sti/hiv, Lilongwe, Malawi, ⁵Kamuzu University of Health Sciences, Centre For Reproductive Health, Blantyre, Malawi, ⁶Liverpool School of Tropical Medicine, UK, Clinical Sciences, Liverpool, United Kingdom, ⁷Malawi-Liverpool-Wellcome Programme, Public Health, Blantyre, Malawi, ⁸CHI Crumlin, Paediatric Infectious Disease, Dublin, Ireland, ⁹Malawi-Liverpool-Wellcome Programme, Early Life Infections, Blantyre, Malawi

Backgrounds: The WHO has declared the elimination of mother-to-child transmission of syphilis a priority by 2030. Syphilis is the second leading infectious cause of stillbirth worldwide. In this study, we used routinely available data to examine the effects of individual- and population-level determinants of syphilis prevalence between 2014-2020 in Malawi.

Methods: We fitted a Bayesian Poisson generalized linear mixed model with spatial- and temporally-structured random effects to estimate the district-level monthly risk of gestational syphilis as a function of individual- and population-level covariates. We also calculated exceedance probabilities of syphilis risk greater than 1 to identify areas with high risk defined as districts with exceedance probability within range 0.8-1.0. Data was extracted from the HMIS (Hospital Management Information System) and the 2015-16 DHS (Demographic Health Survey) datasets.

Results: Overall, there has been an increase in the risk (2014:0.44; CrI=0.42-0.50 to 2019: 1.42, CrI=1.40-1.48). The percentage of districts with a relatively higher probability (0.8-1.0) that exceedance probability of syphilis risk is greater than 1 increased, mostly concentrated in the southern region (2014: 1/27, 4%; 2020: 8/27, 30%). Individual-level covariates including higher maternal education attainment and increased median maternal age were associated with relative 17% (IRR=0.87, CrI=0.77-0.89) and 14% (IRR=0.86, CrI=0.67-1.10) reductions in risk respectively. An increased number of sexual partners was associated with a 42% (IRR=1.42, CrI=1.18-1.72) increase in the risk of gestational syphilis, while an increased rate of HIV was associated with a relative 15% (IRR=1.15, CrI=1.11-1.19) higher prevalence of syphilis.

Conclusions/Learning Points: The modelling approach reveals high risk areas and the risk maps from this analysis can be a useful tool in implementing more targeted interventions and directing resources where there can be maximum impact.

PD024 / #925

Topic: AS06. Infections in early life / AS06.b. Neonatal sepsis

NEONATAL EARLY-ONSET INFECTIONS: COMPARING THE SENSITIVITY OF THE NEONATAL EARLY-ONSET SEPSIS CALCULATOR TO THE DUTCH AND THE UPDATED NICE GUIDELINES IN AN OBSERVATIONAL COHORT OF CULTURE-POSITIVE CASES

E-Posters

VIRTUAL POSTER DISCUSSION SESSION

Linde [Snoek](#)¹, Merel Van Kassel¹, Jurjen Krommenhoek¹, Niek Achten², Frans Plötz^{2,3}, Nina Van Sorge^{4,5}, Matthijs Brouwer¹, Diederik Van De Beek¹, Merijn Bijlsma^{1,2}

¹Amsterdam University Medical Centre, Neurology, Amsterdam, Netherlands, ²Emma Children's Hospital, Amsterdam University Medical Centre, Paediatrics, Amsterdam, Netherlands, ³Tergooi Hospital, Paediatrics, Blaricum, Netherlands, ⁴Amsterdam University Medical Centre, Medical Microbiology And Infection Prevention, Amsterdam, Netherlands, ⁵Amsterdam University Medical Centre, Netherlands Reference Laboratory For Bacterial Meningitis, Amsterdam, Netherlands

Backgrounds: The early-onset sepsis calculator (EOSC) reduces unnecessary antibiotic treatment in newborns. However, its performance in identifying cases with early-onset disease (EOD) is unclear. We compared the sensitivity of the EOSC to the current Dutch and United Kingdom National Institute for Health and Care Excellence (NICE) guidelines.

Methods: Culture-positive *Streptococcus agalactiae* (GBS) and *Escherichia coli* (*E. coli*) sepsis and meningitis patients ≤ 3 days old with a gestational age ≥ 34 weeks, identified in a Dutch prospective nationwide cohort study, were included. Primary outcome was the proportion of patients that would have been treated according to the EOSC, the Dutch, and the NICE EOD prevention guidelines. Differences between proportions were analysed using McNemar's test.

Results: We included 81 GBS and 7 *E. coli* EOD cases. At 4 hours after birth, the EOSC would have recommended antibiotic treatment in 32 (36%) patients, compared to 44 (50%) by the Dutch ($p < 0.01$) and 48 (55%) by the NICE guideline ($p < 0.01$, Figure 1). The EOSC would have initially recommended routine care for 52% of patients compared to 31% and 30% for the Dutch and NICE guidelines ($p < 0.01$). At 24 hours after birth, the EOSC would have recommended antibiotic treatment in 54 (61%) infants compared to 64 (73%) by the Dutch ($p = 0.02$) and 63 (72%) by the NICE guidelines ($p = 0.06$).

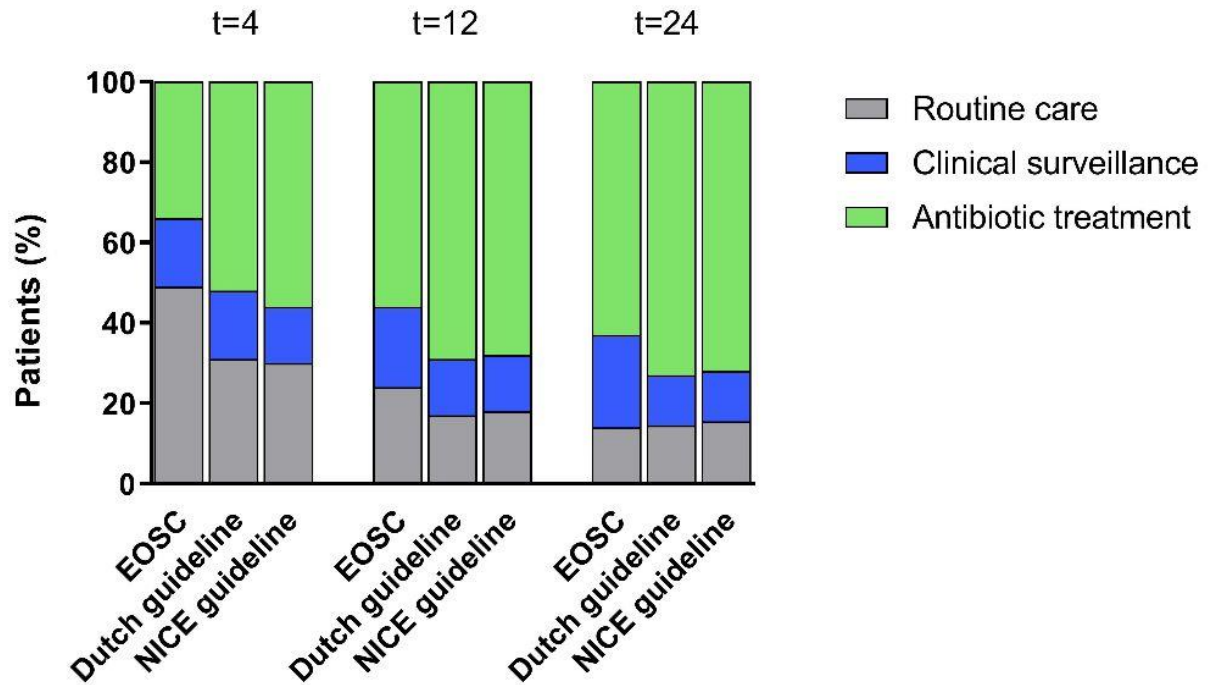

Conclusions/Learning Points: The sensitivity of the EOSC in identifying EOD cases is lower compared to both Dutch and NICE guidelines, especially directly after birth. The EOSC relies more on clinical symptoms and results in less overtreatment of healthy newborns at the cost of later antibiotic treatment in initially well-appearing EOD patients.

PD025 / #1513

Topic: AS13. COVID 19 and MIS-C

SOMATOSENSORY ABNORMALITIES IN CHILDREN AND ADOLESCENTS AFTER INFECTION WITH SARS-COV-2

E-Posters

VIRTUAL POSTER DISCUSSION SESSION

Lynn Eitner¹, Folke Brinkmann², Anne Schlegtendal², Christoph Maier¹, Leona Knoke², Elena Enax-Krumova³, Thomas Lücke¹

¹University Children's Hospital, Neuropaediatrics, Bochum, Germany, ²University Children's Hospital, Paediatric Pneumology, Bochum, Germany, ³BG University Hospital Bergmannsheil gGmbH, Neurology, Bochum, Germany

Backgrounds: Long-term sequelae, including neurological symptoms, have been reported in children and adolescents following SARS-CoV-2 infection, even after a mild course. Therefore, we examined the somatosensory function in children and adolescents after SARS-CoV-2 infection in a case-control study compared with age-matched controls.

Methods: 81 subjects after SARS-CoV-2 infection (n=44 female, 11.4±3.5y, n=75 SARS-CoV-2 seropositive, n=47 asymptomatic infection) were compared to 38 controls without SARS-CoV-2 infection (26 female, 10.3±3.4y, n=15 with other infection within last 6 month). After standardised interviews and neurological examinations, large fibre (tactile and vibration detection thresholds) and small fibre (cold and warm detection thresholds, paradoxical heat sensation) functions were assessed on both feet following a validated protocol. Statistical analyses: t-test, Chi-squared test.

Results: None of the controls, but 27 of 81 patients (33%, p<0.001) reported persistent complaints 2.7±1.9 (0.8-8.5) months after SARS-CoV-2 infection, most often reduced exercise capacity (16%), fatigue (13%), pain (9%), or paraesthesia (6%). Reflex deficits or paresis were missing, but somatosensory profiles showed significantly increased detection thresholds for thermal and vibration stimuli compared to controls. 36% of the patients after SARS-CoV-2, but none of the controls revealed a sensory loss in at least one parameter (p<0.01). Small fibre dysfunction appeared more frequently in children with prior symptomatic SARS-CoV-2 infection. Myalgia/paraesthesia was indicative of somatosensory dysfunction. In all eight re-examined children, the nerve function recovered after 2–4 months.

Conclusions/Learning Points: This study provides evidence that in a subgroup of children and adolescents previously infected with SARS-CoV-2, regardless of their complaints, the function of large or small nerve fibres is presumably reversibly impaired.

PD026 / #1045

Topic: AS13. COVID 19 and MIS-C

EARLY OUTCOMES OF THE MULTISYSTEM INFLAMMATORY SYNDROME IN INFANTS UP TO 60 DAYS OF AGE RELATED TO PRENATAL MATERNAL COVID-19 INFECTION: CASE SERIES

E-Posters

VIRTUAL POSTER DISCUSSION SESSION

Maria Terciu¹, Diana Andone¹, Luciana Petrescu¹, Maria Mitrica^{1,2}, Bianca Popovici^{1,2}, Anca Ilea¹, Oana Falup-Pecurariu^{1,2}

¹Children's Clinical Hospital, Paediatrics, Braşov, Romania, ²Transilvania University, Faculty Of Medicine, Brasov, Romania

Title of Case: EARLY OUTCOMES OF THE MULTISYSTEM INFLAMMATORY SYNDROME IN INFANTS UP TO 60 DAYS OF AGE RELATED TO PRENATAL MATERNAL COVID-19 INFECTION: CASE SERIES

Background: The aim of this study is to evaluate the Multisystem Inflammatory Syndrome in infants associated to prenatal maternal COVID-19 infection.

Case Presentation Summary: Methods: We conducted a prospective observational study on a case series of five infants up to 60 days of age with MIS-C due to vertical transmission of SARS-CoV2 infection, admitted in Children's Clinical Hospital Brasov between January 1st and December 31st 2021. The inclusion criteria were: negative RT-PCR-SARS-CoV2 test, negative IgM-SARS-CoV2 and positive IgG-SARS-CoV2 antibodies, maternal COVID-19 infection in the third trimester of pregnancy. Patients enrolled in this case series were admitted in hospital for acute common illnesses. MIS-C was a secondary finding, after performing laboratory investigations according to their family history. Results: All the five cases were in girls born at mean gestational age of 39 weeks as AGA. Mean age on admittance was 29,2 days and acute respiratory infections were the most frequent admittance cause. CRP was negative in four patients and one patient had CRP mild increased. Ferritin was also elevated as inflammatory marker. The most significant laboratory findings related to MIS-C were the elevated levels of D-dimers, NT-pro-BNP, Troponin T and CK-MB with normal heart function evaluated by echocardiography. Two of the patients received iv immunoglobulin. The follow-up one month after discharge was checked by two patients. Their myocardial biomarkers and ferritin were still elevated, but lower than the first evidences. D-dimers levels were normalized.

Learning Points/Discussion: Conclusion: Subclinical myocarditis is one of the early outcomes of MIS-C related to prenatal maternal COVID-19 infection, a new challenge for the pediatricians of the pandemic era.

PD027 / #1465

Topic: AS02. Public health and epidemiology (only non SARS-CoV2 content) / AS02.a. Population studies and surveillance

INTERNATIONAL IMPORTATIONS OF MEASLES INTO CANADA, 1998-2019

E-Posters

VIRTUAL POSTER DISCUSSION SESSION

Rashmi Narkar¹, Anita Li¹, Joanne Hiebert²

¹Public Health Agency of Canada, Vaccine Preventable Diseases, Ottawa, Canada, ²National Microbiology Laboratory, Viral Exanthemata And Stds, Winnipeg, Canada

Backgrounds: Although endemic transmission of measles has been eliminated in Canada since 1998, the country's elimination status continues to be challenged by importations of measles from other countries. The objective of the study is to describe the epidemiology of measles cases through importations in Canada.

Methods: Measles surveillance data were obtained from the Canadian Measles and Rubella Surveillance System. Descriptive epidemiologic analyses of demographics and risk factors were performed. All reported cases that met the national case definition for measles were included. Genotype and strain identification were performed by the Public Health Agency of Canada's National Microbiology Laboratory.

Results: From 1998 to 2019, 2,256 measles cases were reported in Canada. Of those, 245 (11%) were imported cases, and 1,740 (77%) were linked to an imported case or chain of transmission. The median age of imported cases was 14 years. While under 1 and 1-6 year olds account for 1% and 6% of Canadian population, respectively, 16% and 19% of importations occurred within those age groups. Of the available immunization data (92%) for 1-6 year olds, all imported cases were unimmunized. Overall, 58% and 22% of all imported cases reported travel from countries in Asia and Europe prior to symptom onset, respectively. Of the 161 cases with measles genotype information available, genotype B3 accounted for the largest proportion of importations (39%), followed by D8 (36%).

Conclusions/Learning Points: The occurrence of measles cases, largely due to importations, highlights the importance of maintaining high vaccine coverage within the Canadian population and reminding travellers to maintain up-to-date measles vaccination, especially among children, prior to international travel, to prevent importation of measles from aboard and further transmission once the virus has been imported to Canada.

Topic: AS12. Health associated infections, infection prevention and control

ADOLESCENT VACCINATION SCHEDULE IN NATIONAL IMMUNIZATION PROGRAMS IN LATIN AMERICA AND THE CARIBBEAN

E-Posters

VIRTUAL POSTER DISCUSSION SESSION

Monica Rojas¹, Maria Lucion², Ricardo Becker Feijó³, Antonio Luevanos⁴, Iván Gutierrez⁵, Dora Estripeaut⁶, Andrea Schilling⁷, Maria Eugenia Perez⁸, Luciana Hirata⁹, Cintia Parellada¹⁰

¹MSD, Bogota D.c., Bogota D.C., Colombia, ²Ricardo Gutiérrez Children's Hospital, Buenos Aires, Buenos Aires, Argentina, ³Hospital de Clinicas de Porto Alegre, Pediatrics, Porto Alegre, Brazil, ⁴Antiguo Hospital Civil de Guadalajara, Pediatrics, Guadalajara, Mexico, ⁵Clinica Colsubsidio, Pediatrics, Bogotá, Colombia, ⁶Hospital del Niño doctor José Renán Esquivel, Pediatrics, Panama, Panama, ⁷Clinica Alemana de Santiago, Pediatrics, Santiago de Chile, Chile, ⁸MSD, Medical Affairs, Buenos Aires, Argentina, ⁹MSD, Gcto, Sao Paulo, Brazil, ¹⁰MSD, Core, Sao Paulo, Brazil

Backgrounds: Expanding the adolescent platform is critical to immunization system strengthening. This review aimed to characterize the adolescent immunization schedule in national immunization programs (NIPs) in Latin America and Caribbean (LAC).

Methods: We conducted targeted searches of 34 LAC country profiles on Pan American Health Organization (PAHO), World Health Organization (WHO), and official government websites from September-December 2021. Adolescents were defined as persons from ages 9-19. The main variables were vaccination type (routine or campaign), recommended age, vaccination coverage rate (VCR), funding, and vaccine delivery strategy.

Results: One-hundred and seventy-eight reports were included in this review. Among 34 LAC countries, 33 had at least one vaccine in adolescent immunization schedule (figure 1). The most common routine vaccines were HPV (30 NIPs, 16 targeted both sexes and 14 females only), meningococcal C/ACWY (5NIPs), diphtheria/tetanus (DT/DTaP) booster (33NIPs), and oral polio booster (7NIPs). Vaccination campaigns included COVID-19 (33NIPs), influenza (mainly for high-risk populations), and catch up on missed childhood/adolescent vaccines. The range of recommended ages varied between vaccines: HPV (9-19 years), meningococcal C/ACWY (11-14 years), and DT/DTaP (9-19 years). Few countries provided VCR data. WHO website reported 2020 HPV VCR in 26 LAC countries; VCR for ≥ 1 dose was $> 50\%$ in countries reporting VCR by age 15. All vaccines were primarily publicly funded, and most countries use PAHO revolving fund mechanism. Schools and health centers were primary vaccine delivery sites.

Figure 1. Adolescent routine immunization schedule in national immunization programs in Latin America and the Caribbean, 2021



^aCuba has only TT component, ^b countries that offer OPV booster as part of adolescent schedule. OPV, oral polio vaccine; HPV, Human papillomavirus vaccine; HPV-GNV: gender-neutral HPV vaccination; 4HPV, quadrivalent HPV vaccine; 9HPV, novavalent HPV vaccine; MenACWY, Meningococcal group A, C, W-135 and Y conjugate vaccine; Td, tetanus and diphtheria toxoid for older children/adult vaccines; Tdap: tetanus and diphtheria toxoid and acellular pertussis vaccine; TT: tetanus toxoid.

Conclusions/Learning Points: Although HPV and Td were offered for 9-19-year population, vaccination in NIP was not fully integrated as part of an adolescent platform. Continued efforts are needed to ensure equitable expansion of adolescent vaccination schedule along with health systems strengthening to guarantee effective coverage of interventions in this population.

PD029 / #894

Topic: AS13. COVID 19 and MIS-C

EVALUATING THE VIRUS NEUTRALIZING EFFECT OF SARS-COV-2 NEUTRALIZING ANTIBODIES DEVELOPED BY CONSTRUCTING HIGHLY DIVERSE ANTIBODY LIBRARIES FROM INDIAN POPULATION USING PHAGE DISPLAY TECHNOLOGY

E-Posters

VIRTUAL POSTER DISCUSSION SESSION

Syed Ahmed, Kafil Ahmed, Vyankatesh Pidiyar, Sanket Shah, Safia Syeda
Techinvention Lifecare Pvt. Ltd, Na, Mumbai, India

Backgrounds: The development of scFv antibodies can be an attractive alternative to costly full IgG monoclonal antibodies. Blood samples from Covid-19 recovered patients can be a rich source for amplification and cloning of anti-SARS-CoV-2 antibody genes for antibody phage display library construction and scFv production. The objective of our study was to develop anti-SARS-CoV-2 specific scFv antibody library from blood samples of ten such Indian patients using phage display technology and evaluate the virus neutralizing effect of these binders against the Wuhan wild-type (WT) and Alpha variant.

Methods: Lymphocytes were separated by Ficoll separation for total RNA isolation. Antibody specific genes (VHs-Vks and VHs-Vλs) were PCR amplified and cloned in appropriate phage display expression vector and transformed in specific E. coli strain. Bacteriophage was used for expression of phagemid vector. Biopanning was done against SARS-CoV-2 proteins viz: S1, S2 and RBD. Virus neutralizing assay was conducted by transducing spike pseudotyped virus to ACE2 + HEK293T cells, neutralizing activity was correlated with luciferase activity. Bacteriophage from ELISA positive binders was used to block this interaction to check neutralization activity. ACE2-IgFc microbody was used a control for neutralization.

Results: After stringent biopanning with decreasing concentration of antigens, around 1000 clones were isolated for each target antigens and evaluated for neutralizing activity. Four binders against RBD and S1 have shown robust virus neutralizing activity against Wuhan WT and Alpha variant. Screening with other binders is in progress.

Conclusions/Learning Points: Anti-SARS-CoV-2 specific scFv antibody library was successfully constructed from blood samples of Covid-19 recovered patients. With robust neutralizing effect against the Wuhan WT and Alpha variant, further studies will involve evaluating these binders against other SARS-CoV-2 variants.

PD030 / #1311

Topic: AS03. Vaccines (only non SARS-CoV2 content) / AS03.d. Vaccine efficacy (phase 3) and effectiveness – bacterial and all non-viral

MENINGOCOCCAL SEROGROUP C IMMUNE RESPONSE OF A NOVEL TETANUS TOXOID CONJUGATE QUADRIVALENT MENINGOCOCCAL VACCINE VERSUS QUADRIVALENT OR MONOVALENT C MENINGOCOCCAL VACCINE IN MENINGOCOCCAL VACCINE-NAÏVE TODDLERS

E-Posters

VIRTUAL POSTER DISCUSSION SESSION

Markus Knuf¹, Mika Rämetsä², Nina Stærke³, Yaël Thollot⁴, Siham B'Chir⁵, Habiba Arroum⁶, Isabelle Bertrand-Gerentes⁴

¹Klinikum Worms, Klinik Für Kinder- Und Jugendmedizin, Worms, Germany, ²Tampere University, Vaccine Research Center, Tampere, Finland, ³Aarhus University Hospital, Clinical Medicine, Aarhus, Denmark, ⁴Sanofi, Sanofi Pasteur, Lyon, France, ⁵Sanofi, Sanofi Pasteur, Marcy-l'Étoile, France, ⁶Sanofi Pasteur, Global Pharmacovigilance, Chilly-Mazarin, France

Backgrounds: MenACYW-TT (MenQuadfi®) is a recently licensed quadrivalent meningococcal conjugate vaccine for use in individuals 12 months and older in the EU and some other countries. Safety and immunogenicity (meningococcal serogroup C immune response only) of MenACYW-TT compared to that of a quadrivalent (MCV4-TT [Nimenrix®]) or adjuvanted monovalent meningococcal vaccine (MenC-TT [NeisVac-C®]) were evaluated in healthy meningococcal vaccine-naïve toddlers aged 12-23 months.

Methods: In a double-blind Phase-3 study (NCT03890367) conducted in Denmark, Germany, and Finland, 701 toddlers received one dose of either MenACYW-TT, MCV4-TT or MenC-TT vaccine. Serum bactericidal assays with human (hSBA) and baby rabbit (rSBA) complement were used to measure anti-meningococcal serogroup C antibodies before and 30 days post-vaccination. A sequential statistical testing approach was used. We evaluated the non-inferiority of MenC seroprotection rates (hSBA and rSBA) and the non-inferiority and superiority of GMTs (hSBA and rSBA) induced by MenACYW-TT versus MCV4-TT and versus MenC-TT. Furthermore, we evaluated the superiority of MenC seroprotection rates (hSBA) induced by MenACYW-TT versus MCV4-TT.

Results: As shown in the table we demonstrated the non-inferiority and superiority of MenACYW-TT versus MCV4-TT and versus MenC-TT based on hSBA and rSBA serogroup C GMTs. We also demonstrated the non-inferiority of MenACYW-TT versus MCV4-TT and versus MenC-TT based on hSBA and rSBA serogroup C seroprotection rates. Furthermore, we demonstrated the superiority of MenACYW-TT versus MCV4-TT in terms of hSBA serogroup C seroprotection rates. The safety profiles of MenACYW-TT, MCV4-TT and MenC-TT were comparable.

| Seroprotection rates (≥1:8) and GMTs of serogroup C following a single dose of MenACYW-TT, MCV4-TT and MenC-TT | | | | | | |
|---|---------------------|--|--|----------------------|--------------------------------------|--|
| | PRIMARY OBJECTIVES | | | SECONDARY OBJECTIVES | | |
| | Number of subjects* | hSBA seroprotection rates % (95% CI) | hSBA GMTs (95% CI) | Number of subjects* | rSBA seroprotection rates % (95% CI) | rSBA GMTs (95% CI) |
| MenACYW-TT | 214 | 99.5 (97.4; 100) | 515 (450; 591) | 213 | 100 (98.3; 100) | 2143 (1870; 2456) |
| MCV4-TT | 211 | 89.1 (84.1; 93.0) | 31.6 (26.5; 37.6) | 210 | 94.8 (90.8; 97.4) | 315 (252; 395) |
| MenACYW-TT vs MCV4-TT | | Difference % (97.5% CI) | Ratio (97.5% CI) | | Difference % (97.5% CI) | Ratio (97.5% CI) |
| | | 10.43 (5.68; 16.20) | 16.3 (12.7; 21.0) | | 5.24 (1.83; 9.85) | 6.80 (5.04; 9.18) |
| Conclusion | | Non-Inferiority : YES ¹ Superiority : YES ³ | Non-Inferiority : YES ² Superiority : YES ⁴ | | Non-Inferiority : YES ¹ | Non-Inferiority : YES ² Superiority : YES ⁴ |
| | | rSBA seroprotection rates % (95% CI) | rSBA GMTs (95% CI) | | hSBA seroprotection rates % (95% CI) | hSBA GMTs (95% CI) |
| MenACYW-TT | 213 | 100 (98.3; 100) | 2143 (1870; 2456) | 214 | 99.5 (97.4; 100) | 515 (450; 591) |
| MenC-TT | 215 | 100 (98.3; 100) | 1624 (1425; 1850) | 216 | 99.5 (97.4; 100) | 227 (198; 260) |
| MenACYW-TT vs MenC-TT | | Difference % (97.5% CI) | Ratio (97.5% CI) | | Difference % (97.5% CI) | Ratio (97.5% CI) |
| | | 0.0 (-2.30; 2.28) | 1.32 (1.06; 1.64) | | -0.00 (-2.71; 2.67) | 2.27 (1.82; 2.84) |
| Conclusion | | Non-Inferiority : YES ¹ | Non-Inferiority : YES ² Superiority : YES ⁴ | | Non-Inferiority : YES ¹ | Non-Inferiority : YES ² Superiority : YES ⁴ |

* number of subjects with available data at time point

¹ Non-inferiority demonstrated if the lower limit of the 97.5% CI of the difference is greater than -10% in terms of seroprotection

² Non-inferiority demonstrated if the lower limit of the two-sided 97.5% CI of the ratio of GMTs between groups is > 1/1.5

³ Superiority demonstrated if the lower limit of the 97.5% CI of the difference is greater than 0% in terms of seroprotection

⁴ Superiority demonstrated if the lower limit of the two-sided 97.5% CI of the ratio of GMTs between groups is > 1

Conclusions/Learning Points: MenACYW-TT induced non-inferior / and superior serogroup C immune responses versus MCV4-TT and MenC-TT when administered as a single-dose to meningococcal vaccine-naïve toddlers.

PD031 / #1474

Topic: AS04. Immunology & compromised host / AS04.d. Infections in immunocompromised/ immunodeficient patients

THE USE OF SERUM ENDOTHELIAL ADHESION MOLECULES IN PEDIATRIC PATIENTS WITH LEUKEMIA WITH FEBRILE NEUTROPENIA TO PREDICT BACTEREMIA

E-Posters

VIRTUAL POSTER DISCUSSION SESSION

Kamile Arıkan¹, Eda Karadağ-Oncel²

¹Izmir Buca Research Hospital, Pediatric Infectious Disease, Izmir, Turkey, ²Izmir Tepecik Research Hospital, Pediatric Infectious Disease, Izmir, Turkey

Backgrounds: Febrile neutropenia (FN) represents a life-threatening complication in hematological malignancies. We aimed to analyze the utility of soluble vascular cell adhesion molecule 1 (sVCAM-1), intercellular adhesion molecule 1 (sICAM-1), vascular endothelial growth factor (VEGF) levels compared with C-reactive protein (CRP) and procalcitonin (PCT) during febrile neutropenia episodes of pediatric patients with leukemia.

Methods: Two plasma samples, on day 0 (initial of episode) and day 3 (48-72 hour after episode), for VCAM-1, ICAM-1 and VEGF, CRP and PCT were prospectively collected concomitantly during each febrile neutropenic episode between December 2016 and December 2017. The primary outcome was bacteremia and the secondary outcome was intensive care unit (ICU) admission

Results: Twenty-two (28.6%) acute lymphoblastic lymphoma (ALL), seventeen (22.1%) acute myeloblastic lymphoma (AML) patients and thirty-eight (49.3%) control patients with no known underlying disease or fever were included in this study. Of the 39 patients; 16 (41%) had bacteremia. Mean serum sVCAM1 and sICAM1 levels were significantly higher in control group, compared to FN patients ($p < 0.001$). Mean serum sVCAM2 level was significantly higher in FN patients with bacteremia compared to FN patients without bacteremia (144.97 ± 70.35 pg/mL vs 85.45 ± 53.76 pg/mL, $p = 0.022$). Mean sVCAM1 and 2 levels were higher in FN patients with ICU admission. In this study, we found that sVCAM-1 and VEGF, when combined to CRP and PCT, could predict gram-negative bacteremia in FN episodes of pediatric hematological malignancy.

Conclusions/Learning Points: Serum endothelial adhesion molecules, excluding sVCAM-1, cannot predict bacteremia and ICU admission alone in FN patients; but may be associated with clinical outcome when used with PCT and CRP.

PD032 / #847

Topic: AS13. COVID 19 and MIS-C

OBESITY DRIVES A SEVERE OUTCOMES IN CHILDREN WITH COVID-19

E-Posters

VIRTUAL POSTER DISCUSSION SESSION

Gonzalo Valenzuela¹, Gonzalo Alarcon², Clara Schulze-Schiappacasse², Rocío Rodríguez^{1,2}, Tamara García-Salum^{3,4}, Jorge Levican³, Eileen Serrano³, Leonardo Almonacid³, María José Avendaño³, Catalina Pardo Roa³, Monserrat Gutiérrez⁵, Loreto Godoy⁵, Erick Salinas³, Javiera Aravena¹, Irini Nicolaides¹, Carolina Loza¹, Andrés Muñoz¹, Felipe Soto¹, Astrid Pezoa¹, Diana Manzur¹, José Barriga¹, Salesa Barja⁶, Rafael Medina^{1,2,3,4,7}

¹Pontificia Universidad Católica de Chile, Pediatría, Santiago, Chile, ²Pontificia Universidad Católica de Chile, Department Of Pediatrics, Santiago, Chile, ³Pontificia Universidad Católica de Chile, Laboratory Of Infectious Diseases And Molecular Virology, Santiago, Chile, ⁴Pontificia Universidad Católica de Chile, Department Of Pediatric Infectious Diseases And Immunology, SANTIAGO, Chile, ⁵Hospital Dr Sótero del Río, Paediatric Unit, Santiago, Chile, ⁶Pontificia Universidad Católica de Chile, Departament Of Pediatric Gastroenterology And Nutrition, Santiago, Chile, ⁷Icahn School of Medicine at Mount Sinai, Department Of Microbiology, New York, United States of America

Backgrounds: Obesity is a highly prevalent condition, which identified as a risk factor for severity of viral infections such as influenza, respiratory syncytial virus and recently SARS-CoV-2. Objective: To evaluate the association between obesity and severe outcomes in children with COVID-19.

Methods: Observational study conducted in three tertiary hospitals, included hospitalized children with COVID-19 from March, 2020 to December 31, 2021. Obesity was defined by CDC criteria. Main outcomes were: Hospital stay, ICU admission, ICU stay, oxygen, ventilatory support, vasoactive drugs, superinfections and mortality.

Results: Of 219 patients, 51 (23,3%) patients had obesity. A higher proportion of patients with obesity and >10 years were found. Obesity was associated with higher ICU admission rates (OR 4,7; IC 2,5-9,2, p<0.01), more ventilatory support (OR 4,2; IC 2,2-8,1, p<0.01). Patients with obesity had longer LOS (OR 1.02 (95% CI 1.003- 1.03) p<0.19).

Conclusions/Learning Points: In pediatric SARS-CoV-2 infection, obesity is associated with more ICU admission and ventilatory support. This fact might be relevant when determining optimal treatments for these patients.

PD033 / #693

Topic: AS12. Health associated infections, infection prevention and control

STUDY OF CLINICAL AND MICROBIOLOGICAL PROFILE OF BLOODSTREAM INFECTIONS IN A TERTIARY PEDIATRIC INTENSIVE CARE UNIT: A RETROSPECTIVE OBSERVATIONAL STUDY

E-Posters

VIRTUAL POSTER DISCUSSION SESSION

Bhaskar Shenoy, Shravani Goparaju, Baliwanth Anandakrishnan, Shivakumar Shamarao
Manipal Hospital, Pediatrics, Bangalore, India

Backgrounds: Bloodstream infections (BSIs) cause significant morbidity and mortality in children. Periodic study of local microbial profile and antimicrobial sensitivity patterns helps to make rational antimicrobial choice, coupled with aggressive de escalation policies help us ensure better outcomes , prevent emergence of resistant microbes.

Methods: We retrospectively reviewed community acquired (CA) and hospital acquired (HA) BSIs in children (1 month to 18 years) at Pediatric Intensive Care Unit (PICU), Manipal Hospital over a 7-year period (January 2014-December 2020). Medical records and laboratory data were used to study antimicrobial resistant patterns, incidence, and risk factors. Paired and unpaired-t tests, and Chi-square test were used to test the hypothetical results (after removing outliers)

Results: Of 155 episodes of positive blood culture from 122 patients, 19 were community acquired , 136 were hospital acquired BSIs. Incidence of BSIs were 35 episodes/1000 admissions. Predominant organisms in CABSIs were CONS and EColi. Of 7 Gram negative infections, 3 ESBLs . Most common isolates among HABSIs were Klebsiella Species and CONS. 63.6% of staph.aureus were MRSA, susceptible to vancomycin,teicoplanin and linezolid. Resistant gram negative infections were sensitive to colistin universally. 8.3% of BSIs were fungal isolates out of which 75% were non-albicans candida. All fungal isolates were pansensitive except C.tropicalis (33% resistant to fluconazole) and C. Haemulonii (100% resistant to fluconazole and amphotericin B). CLABSI rate was 8.76/1000 CVC days. Common site of CVC infection was femoral access. 62.6% with BSIs mechanically ventilated, 57% were on vasoactive medications. Mortality rate - 24.5%. . PICU stay, utilisation of CVC, mechanical ventilation and vasoactive medications were high in non-survivors (p<0.005)

Conclusions/Learning Points: High levels of antimicrobial resistance among HABSIs are worrisome. Aggressive implementation of a well-designed hospital infection control strategy is the need of the hour.

PD034 / #1772

Topic: AS12. Health associated infections, infection prevention and control

DEVELOPMENT AND VALIDATION OF AN EFFICIENT NOMOGRAM FOR DIAGNOSIS OF NOROVIRUS INFECTION IN PEDIATRIC PATIENTS

E-Posters

VIRTUAL POSTER DISCUSSION SESSION

Taojun He, Bin Li, Chao Wu, Ying Chen

The eighth affiliated hospital of Sun Yat-sen University, Laboratory Medicine, shenzhen, China

Backgrounds: This study aims to establish a predictive model and nomogram based on laboratory blood routines and clinical symptoms, and provide a rapid diagnostic method for assessing the possibility of norovirus (NoV) infection in children.

Methods:: In this retrospective study, we recruited 86 pediatric patients with symptoms of acute gastroenteritis and detected NoV by real-time fluorescence quantitative PCR (qPCR). Significant indicators selected by multivariate logistic regression, including blood routine and symptoms, developed an effective nomogram to predict NoV infection. We divided the training set and validation set to build the model, and evaluated the clinical performance through the Akaike information criterion (AIC), area under curve (AUC), calibration curve, and decision curve analysis (DCA).

Results: Of the 86 pediatric patients, 45 were NoV PCR positive and 41 were negative. After univariate analysis of 35 independent predictors, multivariate logistic regression found seven predictors e.g., symptoms of bellyache, vomit, cough, upper respiratory tract infection (URI), and blood indicators of platelet crit (PCT), platelet count (PLT) and platelet average distribution width (PDW), which can fit a well diagnostic model for predicting NoV infection. The efficient nomogram showed a significant prediction value with overall diagnosis with AUC of nomogram was 0.889 and 0.931 in training and validation set, respectively.

Conclusions/Learning Points: This efficient nomogram serves as a potential tool for predicting diagnosis of NoV infection for pediatric patients with acute gastroenteritis symptoms, especially in primary community medical care. Furthermore, these easily available predictive indicators can greatly save time of laboratory testing and identification of NoV outbreaks.

PD035 / #1865

Topic: AS06. Infections in early life / AS06.a. Congenital and perinatal infections

MANAGEMENT OF CONGENITAL CYTOMEGALOVIRUS IN PRETERM AND VERY LOW BIRTH WEIGHT INFANTS – AN INTERNATIONAL SURVEY OF PRACTICE

E-Posters

VIRTUAL POSTER DISCUSSION SESSION

Yury Petrunin¹, Helen Payne², Daniel Blázquez-Gamero³, Horst Buxmann⁴, Simon Drysdale⁵, Despoina Gkentzi⁶, Vassiliki Papaevangelou⁷, Hermione Lyall⁸

¹Health Education England, Paediatrics Specialty Training, London, United Kingdom, ²Imperial College London, Paediatric Infectious Diseases, PG, United Kingdom, ³HOSPITAL 12 DE OCTUBRE, Paediatrics, MADRID, Spain, ⁴University Hospital Frankfurt, Neonatology, Frankfurt am Main, Germany, ⁵ST GEORGE'S UNIVERSITY HOSPITALS NHS FOUNDATION TRUST, Paediatric Infectious Diseases, LONDON, United Kingdom, ⁶Patras Medical School, University of Patras, Department Of Paediatrics, Patras, Greece, ⁷National and Kapodistrian University of Athens, Third Department Of Paediatrics, General University Hospital "attikon", Athens, Greece, ⁸Imperial Healthcare NHS Trust, Paediatric Infectious Diseases, London, United Kingdom

Backgrounds: Congenital cytomegalovirus (cCMV) is a leading cause of sensorineural hearing loss (SNHL) and neurodevelopmental disability in children and is more common in preterm births. There are no randomized controlled trials or consensus statements on cCMV management in preterm neonates and this is largely extrapolated from term infant data.

Methods:: We performed an international survey of practice regarding screening; clinical, laboratory and imaging findings; testing modalities; investigations; indications and options for treatment of infants born at less than 32 weeks gestational age or birth weight under 1500 grams. A combination of nonprobability sampling methods was used to distribute the survey among neonatologists and paediatric infectious diseases specialists managing cCMV in level 3 neonatal intensive care units. This was supported by CCMVNET (ccmvnet@gmail.com), the British Association of Perinatal Medicine, and the Spanish Society of Paediatric Infectious Diseases.

Results: We received replies from 51 units across 12 countries. Symmetrical growth restriction or microcephaly with preserved body growth prompt cCMV testing in 52.9% (27/51) and 60.8% (31/51) of units. Cerebellar hypoplasia and neuronal migration disorders prompt testing in 37.3% (19/51) and 43.1% (22/51) of units respectively. Brain stem evoked potentials audiometry, brain MRI, and lumbar puncture are routinely done in 80.4% (41/51), 60.8% (31/51) and 27.5% (14/51) of units respectively. 29.4% (15/51), 17% (8/51) and 13.6% (6/51) of units do not offer treatment to infants with severe single organ disease, isolated SNHL or isolated brain MRI findings consistent with cCMV respectively.

Conclusions/Learning Points: CCMV causes significant long-term morbidity in preterm infants. This survey highlights multiple areas of discrepancy in practice across specialist units and illustrates the need for international collaboration to create an international registry, agree standards of care, and facilitate research to optimise outcomes.

PD036 / #1255

Topic: AS04. Immunology & compromised host / AS04.a. Host-pathogen interaction

SINGLE NUCLEOTIDE POLYMORPHISMS OF VITAMIN D RECEPTOR AND VITAMIN D BINDING PROTEIN (VDBP), BUT NOT VITAMIN D AND VDBP SERUM LEVELS, MAY AFFECT SUSCEPTIBILITY TO VIRAL INFECTIONS IN INFANCY

E-Posters

VIRTUAL POSTER DISCUSSION SESSION

Maria Zacharioudaki, Helen Dimitriou, Emmanouil Galanakis
University of Crete, Paediatrics, Heraklion, Greece

Backgrounds: The role of Vitamin D in innate and adaptive immunity has been recently demonstrated. The purpose of this study was to explore the potential association of genetic variances in vitamin D pathway, 25(OH)Vitamin D and vitamin D binding protein (VDBP) serum levels and infections in infancy.

Methods: This prospective case-control study included infants 0-24 months with infection and age-matched controls. The single nucleotide polymorphisms of vitamin D receptor (VDR) (BsmI, FokI, ApaI, TaqI), VDBP (rs7041, rs4588) and CYP27B1(rs10877012) were genotyped by polymerase chain reaction and restriction fragment length polymorphism analysis. Serum 25(OH)Vitamin D and VDBP levels were determined using Enzyme-linked Immunosorbent Assay (ELISA). Statistical analysis was conducted with two-tailed Fisher exact, Mann-Whitney and Kruskal-Wallis tests.

Results: In total 132 infants were enrolled, of whom 40 with bacterial and 52 with viral infection, and 40 healthy controls. TaqI was more frequent in infants with viral infection compared to controls ($p=0.03$, OR 1.96, 95% CI 1.1-3.58). Moreover, Gc1F was more frequent in the control group compared to infants with viral infection ($p=0.007$, OR 2.7, 95%CI 1.3-5.6). No significant differences were found regarding the genetic profile for VDR and VDBP in infants with bacterial infection compared to controls and regarding CYP27B1 (rs10877012) between the studied groups. Serum 25(OH)Vitamin D and VDBP levels did not differ significantly between infants with viral or bacterial infection compared to controls neither between infants with different VDR and VDBP genotypes.

Conclusions/Learning Points: In this study we demonstrated that genetic variances in vitamin D pathway, but not serum 25(OH)D and VDBP levels, may modulate susceptibility to viral infections in infancy. Our findings further elucidate genetic susceptibility to viral infections and detection of VDR and VDBP genetic profile might help determine high-risk infants.

PD037 / #798

Topic: AS13. COVID 19 and MIS-C

COVID-19 IN CHILDREN ADMITTED TO A TERTIARY CARE HOSPITAL IN PORTUGAL

E-Posters

VIRTUAL POSTER DISCUSSION SESSION

Regina Pinto Silva¹, Inês Pedrosa², Teresa Monteiro³, Ana Reis E Melo⁴, Carolina Faria⁴, Margarida Tavares⁴

¹Centro Hospitalar Universitário de São João, Paediatrics, Porto, Portugal, ²Centro Hospitalar de Leiria, Paediatrics, Leiria, Portugal, ³Centro Hospitalar e Universitário do Algarve, Paediatrics, Faro, Portugal, ⁴Centro Hospitalar Universitário de São João, Paediatrics Infectious Diseases And Immunodeficiencies, Porto, Portugal

Backgrounds: Several reports state that most cases of COVID-19 in children are mild, and treatment consists of supportive care. Aim: Characterize clinical features of children admitted to hospital with confirmed SARS-CoV-2 infection.

Methods: Observational retrospectively study of pediatric patients (0-17 years), admitted to a Portuguese tertiary care hospital from March 2020 to November 2021 with positive SARS-CoV-2 RT-PCR.

Results: Between this period 1127 children had positive SARS-CoV-2 RT-PCR, only 59 (5%), were admitted. 14 (24%) due to COVID-19, the remaining 76% due to other diseases. From the 14, 57% were male, with median age of 9 years (1 month-17 years) and average length of stay 6 days. 71,4% were previously infected by family members. 42,8% had comorbidities (genetic condition, tumor, asthma). Regarding to demographic data of COVID-19 children, there was a significant difference between age groups of affected children ($P = 0,033$) and existence of comorbidities ($P < 0,001$). Fever (78,5%) and dry cough (71,4%) were common symptoms. Gastrointestinal manifestations accounted for 42,8%. 36% were submitted to chest computer tomography (CT) scan image, and typical signs were ground-glass opacity (100%). 86% did a chest radiography, of those 83% had a diffuse hilar infiltrate. Laboratory results were mostly within normal ranges, 2 had lymphopenia, 72% had mild elevation of C-reactive protein (mean 38,2 g/dL). The majority (64%) were mild cases. Only one child was admitted to intensive care unit. 42,8% needed oxygenotherapy, 50% antibiotherapy, and 3 patients corticotherapy, none needed host-directed antiviral therapy.

Conclusions/Learning Points: In our study, patients had a low rate of admission presented with nonspecific symptoms, normal leukocyte count with rare lymphopenia and ground-glass opacity in CT scan. All patients progressed favorably. However, further studies are needed to understand the risk, clinical spectrum, and outcomes of COVID-19.

PD038 / #1848

Topic: AS01. Antimicrobials / AS01.d. Antibiotic Stewardship

IMPACT OF TWO INTERVENTIONS (C REACTIVE PROTEIN POINT-OF-CARE TESTING AND EDUCATION) ON ANTIBIOTIC PRESCRIBING FOR CHILDREN WITH ACUTE INFECTIONS IN PRIMARY CARE IN LATVIA.

E-Posters

VIRTUAL POSTER DISCUSSION SESSION

Zane Likopa¹, Anda Kivite-Urtane², Jana Pavare¹

¹Riga Stradins University, Paediatrics, Riga, Latvia, ²Riga Stradins University, Department Of Public Health And Epidemiology, Institute Of Public Health, Riga, Latvia

Backgrounds: Antibiotics are the most commonly administered prescription drugs for children and around 90% are prescribed in primary care. However, most of acute infection episodes are of viral etiology and do not require specific treatment. The aim of this study is to explore whether implementation of C reactive protein (CRP) point-of-care tests (POCT) and doctor education reduce antibiotic prescribing for children with acute illnesses.

Methods:: Single-arm pre-post intervention study was conducted in Latvia between November 2019 and May 2021. 40 family physicians from various Latvian regions were asked to record data on pediatric patients aged 1 month up to 17 years who were consulted with acute infections with duration of symptoms less than 5 days. After 3 months period all family physicians received CRP POCT and educational course. Antibiotic prescribing rates were compared before and after the interventions carried out.

Results: During 18 months period 1517 patients were included (n=886 in pre-intervention group; n=631 in post-intervention group) with the median age 5.0 years in pre-intervention group and 4.0 years in post-intervention group. The most common infections in both study groups were upper respiratory infections (76.2% (n=675) in pre-intervention group and 71.9% (n=454) in post-intervention group) and lower respiratory infections (20.3% (n=180) in pre-intervention group and 21.1% (n=133) in post-intervention group). For 32.4% (n=287) of patients in pre-intervention group and 32.3% (n=204) patients in post-intervention group antibiotics were prescribed and the difference was not statistically significant (p=0.98).

Conclusions/Learning Points: Our results showed that availability of CRP POCT and family physician education intervention didn't significantly reduce antibiotic prescribing for children with acute infections. Other or additional methods to decrease inappropriate antibiotic prescribing should be considered.

PD039 / #1877

Topic: AS13. COVID 19 and MIS-C

PEDIATRICIANS' PERCEPTIONS AND PRACTICES ON COVID-19 VACCINES FOR CHILDREN: A CROSS-SECTIONAL SURVEY IN ONTARIO, CANADA

E-Posters

VIRTUAL POSTER DISCUSSION SESSION

Yamna Ali¹, Pierre-Philippe Piche-Renaud², Elahe Shahrabak³, Daniel Farrar⁴, Sharon Burey⁵, Shaun Morris²

¹The Hospital for Sick Children, Department Of Paediatrics, Toronto, Canada, ²The Hospital for Sick Children, Infectious Disease, Toronto, Canada, ³The Hospital for Sick Children, Child Health Evaluative Sciences, Toronto, Canada, ⁴Hospital for Sick Children, Centre For Global Child Health, Toronto, Canada, ⁵American Academy of Pediatrics, Pediatricians Alliance Of Ontario, Windsor, Canada

Backgrounds: SARS-CoV-2 vaccination of all age-eligible populations is an important part of the COVID-19 pandemic response. In Ontario, vaccination coverage remains sub-optimal in the 5–11-year group. We sought to understand pediatricians' perception, practices, and barriers to SARS-CoV-2 vaccination in children aged 5-11, to inform interventions and promote capacity of pediatricians as vaccinators and vaccination promoters.

Methods:: This is a descriptive, cross-sectional study consisting of an online self-administered questionnaire distributed to 1,313 pediatricians in Ontario. Chi-square or Fisher's exact tests were performed where appropriate.

Results: In total, 149 Pediatricians responded (11.3% response rate), from February 17, 2022 to March 11, 2022. 77% of respondents were general pediatricians and 23% were pediatric subspecialists. Median years of practice was 17 (5.75-25), with 66% female, 33% male. Most pediatricians thought it was unlikely that children aged 5-11 would become seriously ill from acute COVID-19 caused by Delta (66%) or Omicron (81%). 92% were very likely to recommend the COVID-19 vaccine for children aged 5-11, and 24% reported administering COVID-19 vaccines. COVID-19 vaccine was perceived as safe, with higher safety perception in children aged 5-11 compared to 12-17 ($p=0.04$, Figure 1a). COVID-19 vaccines were thought to be effective in reducing hospitalization or severe illness, and reducing SARS-CoV-2 infection, with higher perceived effectiveness against Delta compared to Omicron ($p<0.0001$, Figure 1b). 66% were very confident in their COVID-19 vaccine counselling for children aged 5-11. Few pediatricians did not feel confident in accessing resources for health professionals (6%) or for patients/caregivers (11%).

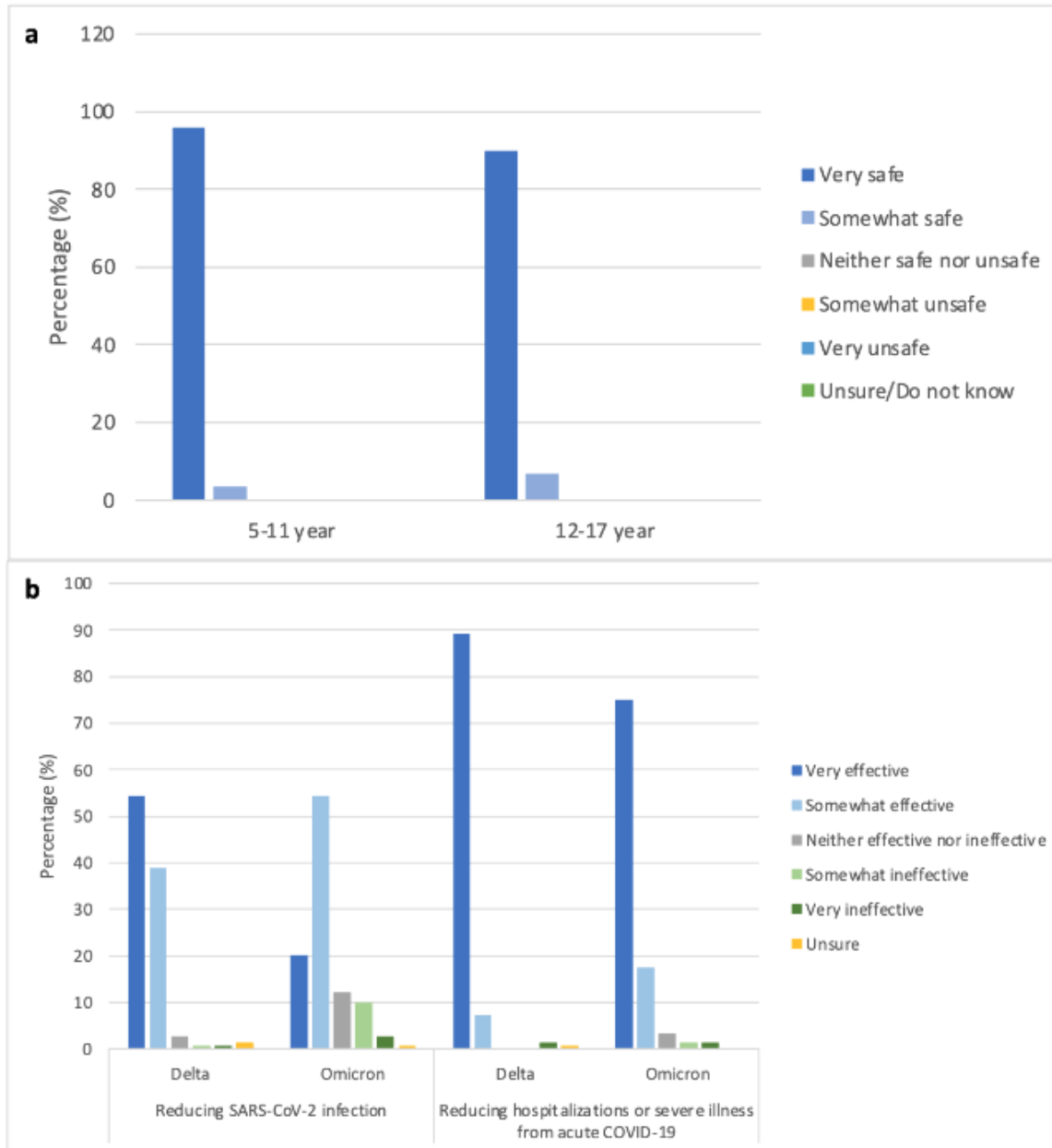

Figure 1: Pediatrician's perceptions on vaccine safety and effectiveness. (a) Pediatricians' perception on COVID-19 vaccine safety among children aged 5-11 years and 12-17 years. **(b)** Pediatricians' opinion of vaccine effectiveness in reducing SARS-CoV-2 infection and reducing hospitalizations or severe illness from acute COVID-19, among children aged 5-11 years with Delta or Omicron SARS-CoV-2 variant.

Conclusions/Learning Points: Most surveyed pediatricians were very likely to recommend the COVID-19 vaccination for children aged 5-11 years, and perceived COVID-19 vaccines as safe and effective. Areas for further training and capacity development were identified.

PD040 / #956

Topic: AS07. Non-respiratory infections / AS07.c. CNS infections

INFECTIVE ENCEPHALITIS IN CHILDREN: A TEN-YEAR EXPERIENCE IN A TERTIARY CARE PAEDIATRIC CENTER.

E-Posters

VIRTUAL POSTER DISCUSSION SESSION

Elisa Casarin¹, Cecilia Liberati², Elisa Barbieri², Marica De Pieri², Costanza Di Chiara², Sara Rossin³, Stefano Sartori⁴, Giorgio Perilongo⁴, Daniele Donà²

¹University of Padua, Department Of Women's And Children's Health, Padova, Italy, ²Paediatric Infectious Diseases, University of Padua, Department For Woman And Child Health, Padova, Italy, ³Paediatric Emergency Department, University of Padua, Department For Woman And Child Health, Padova, Italy, ⁴Paediatric Neurology and Neurophysiology Unit, University of Padua, Department For Woman And Child Health, Padova, Italy

Backgrounds: Infective encephalitis [IE] in children is a rare but potentially severe medical condition with high morbidity and long-term sequelae. Clinical presentation, course, and outcomes are heterogeneous and depend mainly on aetiology. Many cases remain of unknown origin, despite extensive evaluation. This study aims to contribute to the definition of clinical profiles and management of IE, adding to the pertinent literature the 10-year experience at the Department of Woman's and Child's Health of the University Hospital of Padua, Italy.

Methods: This is a single-center, retrospective study, spanning from January 2010 to December 2020. Eligibility criteria were: age less than 15 years and final diagnosis of IE (International Encephalitis Consortium, 2013). Univariate and multivariate analyses were conducted.

Results: The study population included 47 cases, with 27 males and a median age of 1.25 years (range 1-14). Fifteen full-term newborns were included. Aetiology was identified in 40 cases (85%): Enteroviruses were the most common agents (41%), mainly in children younger than four years, followed by Herpes Virus [HVS] (13%), Parechoviruses (11%), *M. pneumoniae* (11%) and others. Children with HSV encephalitis were more likely to present with seizures ($p < 0.001$), increased CSF protein concentration ($p=0.042$) and brain MRI abnormalities ($p=0.018$), and to have a worse outcome ($p < 0.001$). Most cases of enterovirus IE had milder clinical manifestations and favourable outcomes. All HSV EI cases were treated with acyclovir, whilst steroid therapy was tailored according to clinical and radiological severity.

Conclusions/Learning Points: This study confirms the potential severe outcome of children suffering from HSV encephalitis. The use of steroids in association with acyclovir needs to be addressed in prospective collaborative studies, refining diagnostic-therapeutic algorithms combining clinical, laboratory, and instrumental findings.

PD041 / #1868

Topic: AS13. COVID 19 and MIS-C

RSV BRONCHIOLITIS OUTBREAK IN A GREEK PICU DURING THE SECOND YEAR OF COVID-19 PANDEMIC. EPIDEMIOLOGICAL, DEMOGRAPHIC AND CLINICAL SEVERITY DIEFFERENCES.

E-Posters

VIRTUAL POSTER DISCUSSION SESSION

Evdoxia Mpourazani, Marilena Prapa, Eleni Christakou, Chrysanthi Tsirogianni, Kalliopi Straka, Chariklia Barbaresou

AGIA SOPHIA CHILDRENS HOSPITAL, Pediatric Intensive Care Unit, Athens, Greece

Title of Case: RSV BRONCHIOLITIS OUTBREAK IN A GREEK PICU DURING THE SECOND YEAR OF COVID-19 PANDEMIC. EPIDEMIOLOGICAL, DEMOGRAPHIC AND CLINICAL SEVERITY DIEFFERENCES.

Background: RSV is the leading agent that causes bronchiolitis in children younger than 2 years of age. Disease epidemiology and clinical course are well studied and appear traditionally stable over decades. During the first year of COVID-19 pandemic the incidence of RSV infections almost zeroed worldwide. On the contrary, after the reduction of isolation measures, an outbreak was observed, presenting with altered characteristics.

Case Presentation Summary:

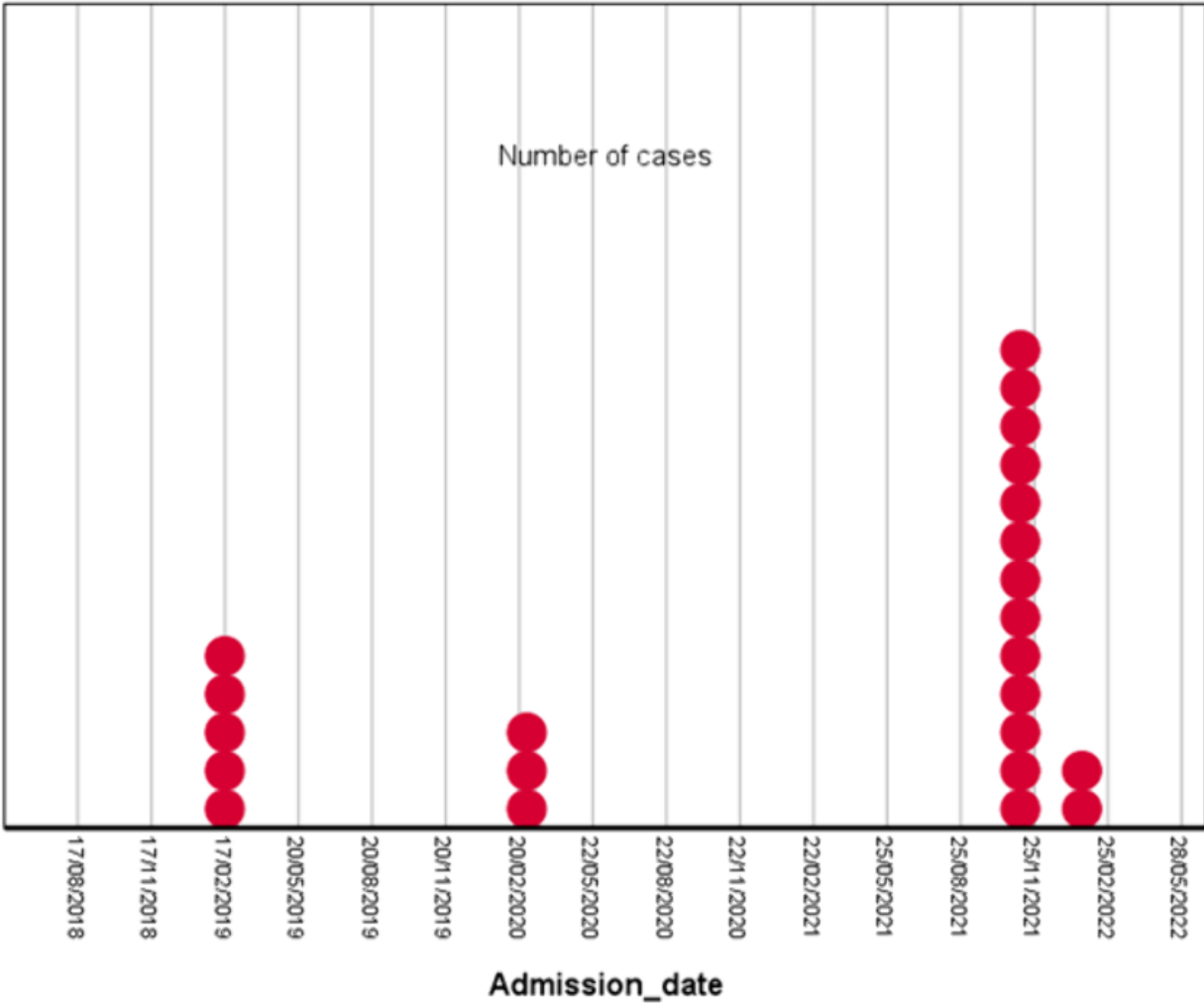

Footnote

We present an outbreak in bronchiolitis cases admitted to our PICU during late autumn- early winter 2021. 15 children with bronchiolitis, exclusively related to RSV (confirmed with nasal PCR) were hospitalized. A 5-fold and 3-fold increase in admission rates were recorded, compared with 2020 and 2019 respectively. There was a great disparity in seasonal distribution of RSV, traditionally regarded as presenting during late winter-early spring period each year. Moreover, an increase in the median age of hospitalized children was observed, as 33,3% of patients aged above 2 years old. 66% of patients required respiratory support with HFNC, and only 3 necessitated invasive mechanical ventilation. This comes in contrast with previous treatment routine, almost exclusively limited to oxygen administration via mask or a Hood device. All our patients displayed favorable outcomes and were discharged home after a short period of time, minus two with serious comorbidities who presented with ongoing respiratory assist demands.

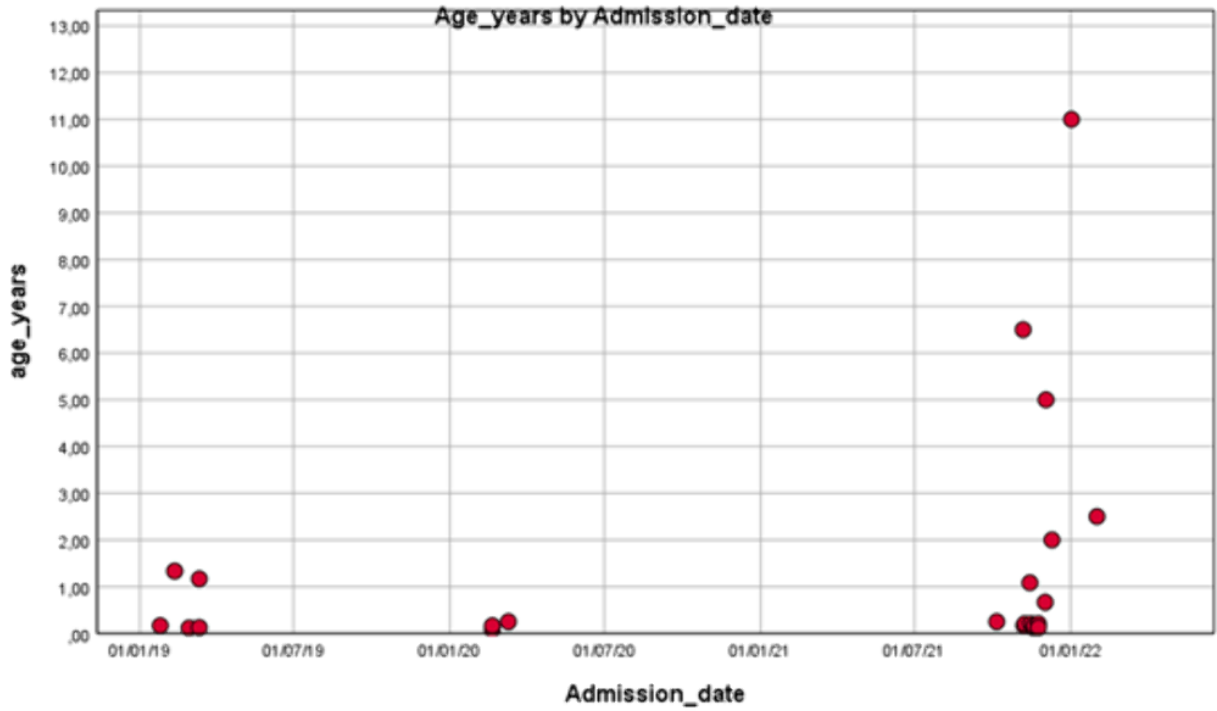

Learning Points/Discussion: Covid-19 pandemic due to strict infection control measures lead to a remarkable decrease in RSV bronchiolitis and highlighted infection transmission control as the most crucial intervention for the prevention of respiratory infections that account for the majority of hospital admissions and pediatric morbidity in developed countries.

PD042 / #1111

Topic: AS03. Vaccines (only non SARS-CoV2 content) / AS03.d. Vaccine efficacy (phase 3) and effectiveness – bacterial and all non-viral

IMMUNE PERSISTENCE, IMMUNOGENICITY AND SAFETY OF A BOOSTER DOSE OF QUADRIVALENT MENINGOCOCCAL CONJUGATE VACCINE (MENACYW-TT) IN ADOLESCENTS AND ADULTS PRIMED 3 - 6 YEARS EARLIER.

E-Posters

VIRTUAL POSTER DISCUSSION SESSION

James Peterson¹, Carmen Deseda², Katie Julien³, Betzana Zambrano⁴, German Anez⁵, Jiayuan Shi⁶, Judy Pan⁶, Habiba Arroum⁷, Kucku Varghese⁸, Emilia Jordanov⁵, Mandeep Dhingra⁵
¹J Lewis Research, Clinical Research, Salt Lake City, United States of America, ²Caribbean Travel Medicine Clinic, Clinical Research, San Juan, Puerto Rico, ³J Lewis Research Inc, Clinical Research, South Jordan, United States of America, ⁴Sanofi Pasteur, Global Clinical Development Strategy, Montevideo, Uruguay, ⁵Sanofi Pasteur, Global Clinical Development Strategy, Swiftwater, United States of America, ⁶Sanofi Pasteur, Global Biostatistical Sciences, Swiftwater, United States of America, ⁷Sanofi Pasteur, Global Pharmacovigilance, Chilly-Mazarin, France, ⁸Sanofi Pasteur, Global Clinical Immunology, Swiftwater, United States of America

Backgrounds: MenACYW-TT [MenQuadfi®] is a quadrivalent meningococcal conjugate vaccine, licensed in ages 12 months and older in the EU and certain other countries.

Methods: A Phase IIIb study evaluated the persistence of immune response in US adolescents and adults, primed 3-6 years earlier (at ages 10-17 years) with either MenACYW-TT or MCV4-CRM (Menveo®). This study also evaluated the safety and immunogenicity of MenACYW-TT administered as a booster dose, with or without concomitant MenB vaccines (Bexsero® or Trumenba®). Serum bactericidal assays with human complement (hSBA) were used to measure antibodies against vaccine serogroups at baseline (Day 0 [D0]), D06 (in a subset) and 30 days post-booster (D30). Safety data were collected up to 6 months post-booster vaccination.

Results: At D0, the hSBA Geometric Mean Titers (GMTs) were higher in participants primed with MenACYW-TT vs MCV4-CRM for serogroups C, Y and W, and comparable for serogroup A. All D0 hSBA GMTs were higher than those observed at the pre-priming dose, suggesting persistence of immunity. At D30, the statistically planned sufficiency of hSBA seroresponse was demonstrated post MenACYW-TT booster dose regardless of the priming vaccine. D30 hSBA GMTs were comparable for serogroups A, Y and W regardless of the priming vaccine and were higher for serogroup C in MenACYW-TT primed participants. The booster dose was well-tolerated and had similar safety profiles regardless of the priming vaccine. The safety profiles were comparable regardless of the MenB vaccine co-administered with MenACYW-TT vaccine.

Conclusions/Learning Points: Priming with MenACYW-TT demonstrated persistence of immune response 3-6 years later. Robust booster responses in participants primed with MenACYW-TT or MCV4-CRM were observed. No evidence of interference in the immune response to the MenACYW-TT vaccine was observed when co-administered with MenB vaccines.

PD043 / #1862

Topic: AS06. Infections in early life / AS06.a. Congenital and perinatal infections

CONGENITAL ZIKA VIRUS SYNDROME AND AUTOIMMUNITY: REPORT OF TWO CASES OF TYPE 1 DIABETES MELLITUS

E-Posters

VIRTUAL POSTER DISCUSSION SESSION

Nivia Arrais¹, Ricardo Arrais¹, Marília Coelho¹, Neifi Deghaide², Eduardo Donadi², Claudia Maia¹, [Maria Isabel Moraes-Pinto](#)³

¹Universidade Federal do Rio Grande do Norte, Pediatria, Natal, Brazil, ²Universidade de São Paulo Ribeirão Preto, Hemocentro, Ribeirão Preto, Brazil, ³Universidade Federal de São Paulo - UNIFESP, Division Of Pediatric Infectious Diseases - Department Of Pediatrics, São Paulo, Brazil

Title of Case: CONGENITAL ZIKA VIRUS SYNDROME AND AUTOIMMUNITY: REPORT OF TWO CASES OF TYPE 1 DIABETES MELLITUS

Background: Congenital Zika virus syndrome (CZS) has been diagnosed since 2015, with neurotropism causing brain malformations. Type 1 diabetes mellitus (DM1) is an immune-mediated process where autoantibodies destroy pancreatic β cells in genetically predisposed individuals. Patients with congenital rubella or cytomegalovirus are at increased risk of developing DM1. Herein we describe two cases of CZS and DM1.

Case Presentation Summary: In a cohort of 71 children with CZS, two (2.8%) developed DM1. CHILD1. Born in 2015, female, to woman who had febrile illness at the 12th gestational week, had microcephaly at birth (z-score -2.46). Cranial tomography revealed several malformations suggestive of congenital infection. At 25 months of age, she developed diabetic ketoacidosis. She has positive anti-glutamic acid decarboxylase and anti-insulin antibodies and was heterozygous for HLA class II haplotypes (DRB1*03*16-DQB1*02*05), associated with genetic predisposition to DM1 development. CHILD2. Born in 2015, male, to woman who had febrile rash at the eighth gestational week, with head circumference of 30 cm (z-score -2.0). He developed microcephaly in the first months of life. Neuroimaging exams revealed several malformations. At the age of four years, he was diagnosed with DM1. He had positive anti-islet antibodies and was homozygous for HLA class II haplotypes (DRB1*03-DQB1*02) associated with genetic predisposition to DM1.

Learning Points/Discussion: To our knowledge, these are the first reports of patients with CZS who developed DM1. The involvement of Zika virus as an environmental factor that could trigger autoimmunity and DM1 is suggested. A continuous and careful monitoring of these children can evidence and clarify this association.

PD044 / #1896

Topic: AS05. Global health / AS05.a. Zoonosis, vector-borne and emerging infections

THE DENGUE COVID SYNDEMIC IN THE CARIBBEAN

E-Posters

VIRTUAL POSTER DISCUSSION SESSION

Tracy Evans Gilbert¹, Shu Xian Lee², Melanie Fisher², Gabriel Gonzalez Escobar³

¹University of the West Indies Western Campus, Child And Adolescent Health, Montego bay, Jamaica, ²West Virginia University, Department Of Medicine, Section Of Infectious Diseases, Morgantown, United States of America, ³Caribbean Public Health Agency, Laboratory Services, Port of Spain, Trinidad and Tobago

Backgrounds: Similarities in clinical, laboratory, and cytokine responses have been demonstrated in Dengue Fever and COVID19 diseases. This study aims to determine a geographical correlation between COVID 19 mortality and the prevalence of dengue fever.

Methods:: This is a geographical ecological study among 16 Caribbean islands. Using secondary online data sources, we compared COVID-19 and dengue mortality with dengue incidence rates among Caribbean islands. To minimize the impact of vaccination on outcomes, data from 2020 was used. The percentage of the population > 65 years, income level, hospital beds/ 1000 people, physicians /1000 people, and nurses/ 1000 people were assessed for correlations with mortality outcomes. Pearson correlations were calculated using SPSS version 20

Results: Demographic, health system indicators, and COVID 19 mortality varied among islands with the widest disparity in dengue incidence rates. Dengue mortality and dengue incidence rate were found to be moderately positively correlated, $r(14) = .528$, $p = .036$. There was no correlation with dengue incidence rate and COVID mortality, $r(14) = .1$, $p = .713$. COVID 19 and dengue mortality were not associated with percentage population >65 years or health system indicators

Conclusions/Learning Points: There was no ecological link in islands with high dengue incidence rates and COVID mortality. Dengue mortality correlated with high dengue incidence rates. This study did not demonstrate disease synergism. Further evaluation of cases of dengue COVID coinfections can provide additional insight into the dengue COVID 19 syndemic. A high index of suspicion should be maintained in dengue-endemic countries to avert delayed diagnoses.

PD045 / #377

Topic: AS02. Public health and epidemiology (only non SARS-CoV2 content) / AS02.b. Modelling studies

COMPARING THE PUBLIC HEALTH IMPACT OF THE PEDIATRIC 15- AND 20-VALENT PNEUMOCOCCAL CONJUGATE VACCINE IN SWEDEN

E-Posters

VIRTUAL POSTER DISCUSSION SESSION

Vishalini Sundaram¹, Matt Wasserman¹, Andreas Palmborg², Cheryl Mcdade³, Ann-Charlotte Dorange⁴, Mickey Wilson³, [Johnna Perdrizet](#)¹

¹Pfizer Inc., Patient Health Impact, Vaccines, New York, United States of America, ²Pfizer AB, Medical Affairs, Sollentuna, Sweden, ³RTI Health Solutions, Health Economics And Outcomes Research, Research Triangle Park, United States of America, ⁴Pfizer AB, Health & Value, Sollentuna, Sweden

Backgrounds: The introduction of pneumococcal conjugate vaccines (PCVs) in pediatric national immunization programs (NIPs) have had a substantial global impact, however disease burden remains due to non-covered serotypes. In Sweden, where the 10-valent vaccine (PCV10) is part of the infant NIP, PCV10 covers only 7% of residual invasive pneumococcal disease (IPD) in children <5 years old. The 15-valent (PCV15) covers 35% of residual burden, while 20-valent (PCV20) covers 53% of residual burden. The objective of this study is to determine the public health impact of switching from PCV10 to PCV15 or PCV20 in Sweden's infant NIP.

Methods: A decision-analytic model was adapted to estimate IPD, hospital and non-hospital pneumonia, otitis media (OM) cases and deaths from switching to PCV15 or PCV20 in the 2024 NIP. The model utilized historical age-stratified real-world data to estimate future disease. Future IPD incidence, assuming a switch to higher-valent vaccines in 2024, is projected by calculating annual percent reductions in PCV13-10 type IPD incidence based on a systematic review. We assume that PCV20-13 type IPD incidence reductions will be equal to those reported for PCV13-10 serotypes. OM and pneumonia incidence are assumed to vary proportionately with IPD.

Results: Compared to PCV15, switching to PCV20 is estimated to prevent 569 IPD cases, 571 OM cases, 2,734 hospitalized pneumonia cases and 103 non-hospitalized pneumonia cases, amounting to a total of 3,977 pneumococcal disease cases and 219 deaths over 5 years.

| Figure 1: Results from Public Health Impact Analysis in the Overall Population | | | |
|--|----------------|---------|--------------------|
| Results | Overall | | Incremental |
| | PCV20 | PCV15 | (PCV20-PCV15) |
| Outcome | | | |
| Number of pneumococcal disease cases | | | |
| Total disease cases | | | -3,977 |
| Bacteremia | 6,125 | 6,620 | -496 |
| Meningitis | 907 | 981 | -73 |
| Otitis media | 65,370 | 65,941 | -571 |
| Non-hospitalized pneumonia | 120,670 | 120,773 | -103 |
| Hospitalized pneumonia | 34,055 | 36,789 | -2,734 |
| Deaths | | | |
| Total deaths | | | -219 |
| IPD | 731 | 793 | -61 |
| Hospitalized pneumonia | 1,893 | 2,050 | -157 |
| Abbreviations: OM = Otitis media, IPD = invasive pneumococcal disease; PCV = pneumococcal conjugate vaccine | | | |

Conclusions/Learning Points: Replacing PCV10 with PCV20 is estimated to provide greater health impact compared to PCV15 in Sweden, given that the largest proportion of remaining pneumococcal disease burden is due to PCV20-unique serotypes. Thus, PCV20 has the potential to reduce disease further by protecting against additional non-covered serotypes and improve public health.

PD046 / #1129

Topic: AS11. Diagnostics and biomarkers

CLINICAL SIGNIFICANCE OF APOLIPOPROTEIN A1 AS SEVERE SEPSIS BIOMARKER IN CRITICALLY ILL CHILDREN

E-Posters

VIRTUAL POSTER DISCUSSION SESSION

Gajanand Singh Tanwar, Kk Somashekhar, Priya Tanwar, Palak Patel, Divya Mohta, Renu Agrawal
S. P. Medical College,, Pediatrics, BIKANER, India

Backgrounds: Sepsis is the leading cause of death worldwide in paediatric population. Systemic inflammatory response syndrome (SIRS) induces the release of lipid mediators, which control both lipid metabolism and inflammation. However, the role of serum Apolipoprotein A1 (Apo-A1) in children sepsis is poorly understood. This prospective study was conducted to evaluate the relationship between the intensity of the systemic inflammatory response and changes in Apo A1 level in critically ill children admitted to paediatric intensive care unit (PICU) with severe sepsis/septic shock.

Methods: This hospital based prospective observational study was conducted in 2020-2021 enrolling children (aged 2 month to 14 years) with clinically suspected sepsis as per definition given by International Pediatric Sepsis Consensus Conference. Total 154 children were investigated for Apo-A1 estimation by immunoturbidimetric method with authorization from Institutional ethical committee and informed consent from parents.

Results: Apo-A1 levels were significantly lower in children with sepsis (n=154) (65.6 ± 32.9 mg/dl) in comparison to non sepsis control (n=150) (209.5 ± 4.9 mg/dl) ($p < 0.01$). The study revealed significantly lower Apo-A1 levels in children with severe sepsis/septic shock (32.5 ± 30.9 mg/dl) in comparison to SIRS (79.1 ± 50.6 mg/dl) ($p = 0.006$); and in children with mortality (18.4 ± 4.9 mg/dl) in comparison to children who recovered (53.4 ± 39.0 mg/dl) ($p < 0.001$). Bone and joint sepsis were significantly associated with lower Apo-A1 levels (14.9 ± 8.9 mg/dl) followed by cardiovascular (22.4 ± 4.9 mg/dl), gastrointestinal (23.5 ± 8.9 mg/dl), neurological (48.2 ± 45.9 mg/dl) and renal involvement (48.9 ± 27.9 mg/dl). Bivariate correlation between CRP and Apo-A1 level revealed negative correlation ($r = -0.24$, $p = 0.02$).

Conclusions/Learning Points: Apo-A1 seems to be a useful biomarker for identification of sepsis, and also for discriminating between SIRS and severe sepsis. Apo-A1 levels also predict the length of stay in PICU and outcome as mortality.

PD047 / #1137

Topic: AS04. Immunology & compromised host / AS04.b. Host response diagnostics and imaging

VASCULAR ENDOTHELIAL GROWTH FACTOR AS A NOVEL INDICATOR OF DENGUE SEVERITY IN CHILDREN

E-Posters

VIRTUAL POSTER DISCUSSION SESSION

Gajanand Singh Tanwar, Palak Patel, Priya Tanwar, Kk Somashekhar, Divya Mohta
S. P. Medical College,, Pediatrics, BIKANER, India

Backgrounds: Dengue has dramatic increase in India since past two decades with severity expansion. Despite of few published reports in adult age group, there is very little knowledge about its pathogenesis to cause severity and mortality in children. Vascular endothelial growth factor (VEGF) plays a crucial role in the host defense against viral infection causing endothelial permeability and inflammation as well as coagulation. The present study was undertaken to evaluate the role of VEGF in severity of dengue fever in children.

Methods: This prospective study enrolled 81 children during 2020-2021. At admission, serum from all the study subjects was subjected to the standard enzyme-linked immunosorbent assay test for VEGF analysis with authorization from Institutional ethical committee and informed consent from parents.

Results: VEGF levels were found significantly higher ($\chi^2= 62.7$; $p<0.001$) in dengue patient ($n=81$) (547.90 ± 442.09 pg/ml) in comparison to non febrile healthy control ($n=48$) (64.8 ± 16.2 pg/ml) and non dengue febrile ($n=56$) (128.8 ± 76.2 pg/ml) controls. The study revealed that VEGF titers ($\chi^2= 49.7$; $p<0.001$) were significantly increased in severe dengue [SD, $n=5/81$ (6.2%)] (1830.0 ± 481.9 pg/ml) and dengue with warning signs [DWWS, $n=29/81$ (35.8%)] (720.0 ± 245.9 pg/ml) in contrast to dengue without warning signs [DwoWS, $n=47/81$ (58.0%)] (305.32 ± 159.45 pg/ml). Bivariate correlation of VEGF with SGOT and SGPT revealed positive correlation ($r= 0.5$, $p<0.001$) while with platelet unveiled negative correlation ($r = -0.3$, $p<0.001$). In addition, VEGF cut-off of 600 pg/ml with AUROC value of 0.945 (95% CI: 0.895 - 0.995) indicated its excellent potential ($p = <0.001$) to serve as a novel dengue severity marker.

Conclusions/Learning Points: The study emphasized the utility of VEGF titers as a novel indicator of dengue severity with its crucial role in differentiating DWWS and SD at the febrile phase of infection.

PD048 / #1242

SARS-COV-2 IGG POSITIVITY IN VACCINATED AND NON-VACCINATED CHILEAN CHILDREN: A NATIONAL CROSS-SECTIONAL STUDY IN SCHOOLS

E-Posters

POSTER DISCUSSION SESSION 01: COVID VACCINES & IMMUNOLOGY

Juan Pablo Torres¹, Denis Saure², Leonardo Basso², Marcela Zuñiga³, Andre Cazor⁴, Miguel O'ryan⁵

¹University of Chile, Department Of Pediatrics, Division Of Pediatric Infectious Diseases, Vitacura, Chile, ²University of Chile, Instituto Sistemas Complejos De Ingenieria, Santiago, Chile, ³Ministry of Health, Subsecretaria De Redes Asistenciales, Santiago, Chile, ⁴Ministry of Education, Ministry Advisor, Santiago, Chile, ⁵University of Chile, Insituto Ciencias Biomedicas, Programa De Microbiologia, Santiago, Chile

Backgrounds: COVID-19 vaccination of children is gaining global support. We previously reported COVID-19 IgG-seropositivity in adults vaccinated in Chile. Now, we report IgG-seropositivity in vaccinated and non-vaccinated Chilean school-aged children, aiming to compare seropositivity relative to adults receiving the inactivated vaccine (Sinovac) or the mRNA vaccine (Pfizer/BioNTech) within one to twenty weeks before sample collection, or no vaccine.

Methods: We performed IgG testing using the Onsite[®] rapid test (CTK-Biotech,US). Twenty-four schools in the 3 most populated regions in Chile were invited. Accepting parents signed informed consent (children >8 years of age an assent). Trained staff obtained basic information, vaccination dates and performed the test, as well as surveillance data that were uploaded to a database.

Results: A total of 2302 children have been included (Figure 1). While most Sinovac recipients were 6-11 years old (920), Pfizer/BioNTech recipients were almost exclusively 12-18 years old (647). IgG-positivity was significantly higher for Pfizer/BioNTech compared to Sinovac recipients for all study variables except comorbidities. For 670 children receiving the Pfizer/BioNTech vaccine seropositivity was 91,7% 3-4 weeks after the second dose, with figures above 90% by 20 weeks after full vaccination. For 1506 children receiving Sinovac, seropositivity was 91.8 % 3-4 weeks after the second dose, with a declining trend thereafter.

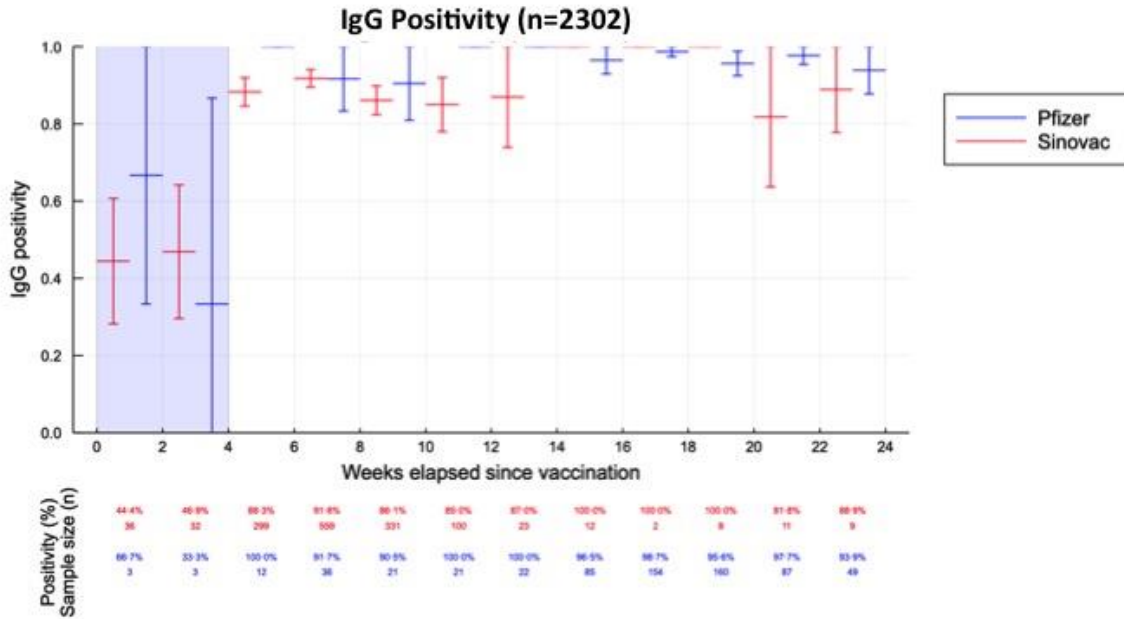

Figure 1. Seropositivity 1 to 4 weeks after a first dose (light blue-shaded region) or after a second dose for recipients of Sinovac or Pfizer vaccines with no prior positive PCR result. Error bars represent 95% confidence intervals.

Conclusions/Learning Points: SARS-CoV-2 IgG-seropositivity surpassed 90% two weeks after administration of a second dose in the case of the inactivated vaccine and up to 10 weeks in the case of the mRNA vaccine. Compared to the adult population, children showed a slightly weaker response to the mRNA vaccine and a slightly stronger response to the inactivated vaccine. Impact on protection against infection and especially severe disease of the COVID vaccines has yet to be elucidated in children.

HUMORAL IMMUNE RESPONSE IN SARS-COV-2 VACCINATED HIV-VERTICALLY TRANSMITTED PATIENTS

E-Posters

POSTER DISCUSSION SESSION 01: COVID VACCINES & IMMUNOLOGY

Marta Stracuzzi¹, Claudia Vanetti², Daria Trabattoni², Valeria Rubinacci¹, Claudio Fenizia^{2,3}, Giulia Meraviglia¹, Mara Biasin³, Gian Vincenzo Zuccotti⁴, Mario Clerici⁵, Vania Giacomet⁶

¹Università degli Studi di Milano, Pediatric Infectious Disease Unit, Luigi Sacco Hospital, Milano, Italy, ²Università degli studi di Milano, Chair Of Immunology - Department Of Pathophysiology And Transplantation, Milan, Italy, ³Università degli studi di Milano, Department Of Biomedical And Clinical Sciences "Luigi Sacco", Milan, Italy, ⁴Università degli studi di Milano, Department Of Pediatrics, V. Buzzi Children's Hospital, Department Of Biomedical And Clinical Sciences "L. Sacco" And Pediatric Clinical Research Center "romeo Ed Enrica Invernizzi", Milan, Italy, ⁵Università degli studi di Milano IRCCS Fondazione Don Carlo Gnocchi, Department Of Pathophysiology And Transplantation, Milan, Italy, ⁶università degli studi di milano, Pediatric Infectious Disease, Milano, Italy

Backgrounds: Certain vaccines prompt suboptimal responses in PLWH. The effect of SARS-CoV-2 vaccines and its long-lived immune response in vertically transmitted HIV young individuals has not been fully investigated yet.

Methods: In this study, we assessed SARS-CoV-2-specific neutralizing antibody titer (NTA) against both the European (EU, lineage B.1) and the Delta (D, B.1.617.2) strains in 22 BNT162b2 mRNA-vaccinated ART-treated patients reporting vertically-transmitted HIV infection and followed at the Pediatric Infective Disease Unit of Luigi Sacco Hospital, Milan, Italy. Analyses were performed over 7 months from the first vaccine dose (T0: one day before vaccination; T1: 25 days after II dose; T2: 6 months after II dose). Results at 6 months were compared with those obtained in 20 BNT162b2 mRNA-vaccinated HIV-negative age-matched volunteers.

Results: In PLWH the percentage of waning of NTA from T1 to T2 was similar when comparing EU and the D strains (87,5% and 82%, respectively), although the Delta strains displayed a moderate immune escape, as demonstrated by the lower neutralization titer (EU T1= 456; D T1= 144). HIV patient with a history of SARS-CoV-2 infection reported higher levels of NTA, both at T1 and T2, and a lower titer dropping compared to individuals without experience of natural SARS-CoV-2 infection (42,7% vs 87,5% respectively). Comparing the results at 6 months with those obtained in HIV-negative age-matched volunteers, no significant differences emerged between the two groups.

Conclusions/Learning Points: BNT162b2 mRNA vaccine is highly immunogenic, supporting vaccination for ART-responder HIV-infected subjects. NTA is considered a correlate of protection from SARS-CoV-2 and the effects of waning immunity predicts a loss of protection after vaccination. A booster vaccination should enable higher neutralization to SARS-CoV-2 than is achieved with primary vaccination also in HIV-vertically transmitted young individuals.

PD050 / #500

THE IMPACT OF PARENTAL VACCINATION AGAINST SARS-COV2 ON PARENTAL AND CHILDHOOD STRESS DURING THE PANDEMIC

E-Posters

POSTER DISCUSSION SESSION 01: COVID VACCINES & IMMUNOLOGY

Despoina Gkentzi, Elina Terzi, Ageliki Karatza, Xenophon Sinopidis, Gabriel Dimitriou, Sotirios Fouzas
Patras Medical School, University of Patras, Department Of Paediatrics, Patras, Greece

Backgrounds: The impact of parental vaccination status against COVID-19 on parental and childhood stress has not been thoroughly investigated. We hypothesize that vaccinated parents and their offspring may experience lower stress levels than the vaccine hesitant ones.

Methods: A cross-sectional study (e-survey) was conducted during May 2021 using the Perceived Stress Scale (PSS) and the Revised Impact of Event Scale (IES-R) for parents. The psychological impact on children was assessed using the Children's Revised Impact of Event 13 (CRIES 13) scale. A convenience sample of Greek parents was enrolled across the country

Results: A total of 1745 parents entered the electronic database and 1703 answers were considered valid (response rate 97.6%). Out of the study participants, 332(19.5%) were completely vaccinated for COVID-19, 403(23.7%) were partially vaccinated, 652 (38.3%) reported that they have decided that would get vaccinated once they get an appointment and 316 (18.5%) were vaccine hesitant. The underlying stress levels were significantly lower in parents completely or partially vaccinated (n=735) versus parents that were vaccine hesitant (n=316) (ANOVA $p < 0.001$ for both PSS and IES-R). In multivariable analysis, vaccination status was a strong predictor of PSS and IES-R scores, independently of parental sex, age, education, place of residence and underlying comorbidity ($p < 0.001$). As for childhood stress data were available for 2969 children aged 9.7 \pm 5.5years. Childhood stress was lower in children whose parents` have been completely or partially vaccinated versus vaccine hesitant parents (ANOVA $p < 0.001$).

Conclusions/Learning Points: Publicly available information about the vaccine benefits apart from disease protection may highlight the benefit of vaccination on the psychological health that has been largely affected by the pandemic. In addition, vaccine hesitant parents and their offspring may require particular attention and support with regards to their mental health.

PD051 / #510

PSYCHOSOCIAL IMPACT OF THE COVID PANDEMIC ON BRITISH PARENTS CARING FOR AN IMMUNOSUPPRESSED CHILD

E-Posters

POSTER DISCUSSION SESSION 01: COVID VACCINES & IMMUNOLOGY

Corine Driessens¹, Lynne Mills², David Culliford¹, Ravin Patel³, Emma Lee², Diane Gbesemete^{2,3}, Harry Chappell², Meera Shaunak², Saul Faust^{3,4}, Hans De Graaf^{2,3}

¹University of Southampton, NihR Applied Research Collaboration Wessex, Southampton, United Kingdom, ²University Hospital Southampton NHS Trust, NihR Southampton Clinical Research Facility And Biomedical Research Centre, Southampton, United Kingdom, ³University of Southampton, Faculty Of Medicine And Institute For Life Sciences, Southampton, United Kingdom, ⁴University of Southampton, NihR Southampton Clinical Research Facility, Southampton, United Kingdom

Backgrounds: Although several studies have reported the psychosocial impact of the COVID pandemic, rarely have these studies focused on the impact on those deemed clinically extremely vulnerable. In this study we explored COVID concern experienced by parents caring for an immunosuppressed child.

Methods: Immunocompromised paediatric patients and their parents were recruited from 46 British hospitals to participate in ImmunoCOVID-19 study. Weekly surveys between March 2020 and September 2021 captured concerns of 765 parents. Growth mixture modelling was used to identify distinct groups of parental concern growth trajectories and their predictors. Thematic analysis was performed to examine in more detail the source of concern.

Results: We identified four distinct groups of parental concern: medium concern with full adaptation over 18 months (20.1%); medium with some adaptation (34.2%); high with some adaptation (34%); and high with no adaptation (11.7%). Child's medical characteristics such as nephrotic, respiratory disease, wait-listed for organ transplant, and prescription of medications used in these conditions were risk factors for belonging in the ongoing very high concern group as was residency in the North of England and parental vocational inactivity. Parents expressed concerns about their child's health, worried about impact of delayed healthcare, were confused by the contradictory information received from government, researchers, doctors, and the media, and also mentioned the impact of shielding and repeated isolation on their child's education, social life, and mental health.

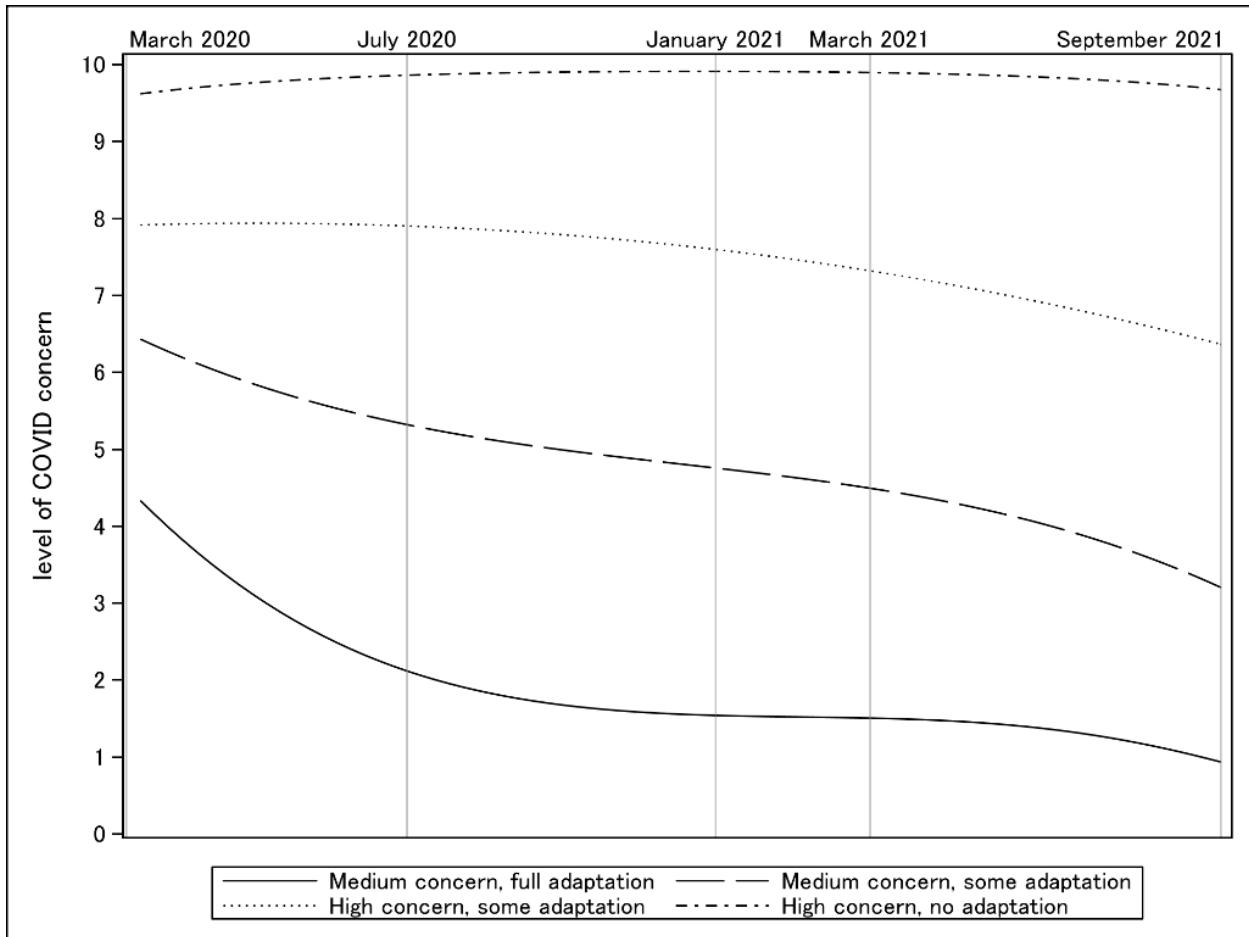

Conclusions/Learning Points: Parental concern levels were high at the start of the pandemic. Most parents adapted to the ever-changing realities of the pandemic, but some parents experienced a continuous high level of concern with no signs of adaptation. This information can be helpful in targeting psychological family care where it is most needed.

PD052 / #552

ASSOCIATION OF KNOWLEDGE AND RISK PERCEPTIONS OF MANILA CITY SCHOOL TEACHERS WITH COVID-19 VACCINE ACCEPTANCE

E-Posters

POSTER DISCUSSION SESSION 01: COVID VACCINES & IMMUNOLOGY

Mikaela Salanguit¹, Janel Quinto¹, Anne Balderrama¹, Frances Hocson¹, Ernesto Gregorio, Jr.¹, Maylin Palatino²

¹University of the Philippines Manila, College Of Public Health, Manila, Philippines, ²Brown University Global Health Initiative, The Philippine Health Initiative For Research, Service, And Training, Providence, United States of America

Backgrounds: In addressing vaccine acceptance, teachers may play a pivotal role as educators and models of behavior, as they serve as reliable sources of information. Thus, this study aimed to determine the association between knowledge and risk perception of teachers and their acceptance of the COVID-19 vaccine.

Methods: This study utilized an analytic, cross-sectional design. Seven hundred and seven public secondary school teachers in Manila City, Philippines accomplished the online self-administered questionnaire. The study was guided by the Health Belief Model (HBM). Multiple logistic regression was used to determine the factors associated with acceptance of the COVID-19 vaccine.

Results: Respondents had a high knowledge on COVID-19 mode of transmission (95.2%), signs and symptoms (92.9%), diagnosis (57.6%), treatment (98.9%), and prevention (92.2%). They had a high risk perception (>69.2%) pertaining to four constructs (Perceived Susceptibility, Perceived Severity, Perceived Benefits, Cues to Action) of the HBM. Low risk perception of barriers was observed (66.1%). The majority (92.5%) are willing to accept the COVID-19 vaccine. Respondents who teach health-related subjects (94.4%) garnered more vaccine acceptors compared to teachers of non-health-related subjects (91.6%). After adjusting for sex, age, highest educational attainment, and subjects taught, Cues to Action remained to be associated with COVID19 vaccine acceptance.

Conclusions/Learning Points: Although high levels of knowledge and risk perceptions were observed, only Cues to Action had a significant association with COVID-19 vaccine acceptance. Hence, they need external cues, from physicians or the Food and Drug Administration, to accept the COVID-19 vaccine.

PD053 / #1002

COVID-19 BREAKTHROUGH DISEASE IN FULLY VACCINATED PAEDIATRIC PATIENTS WITH RHEUMATIC DISEASES

E-Posters

POSTER DISCUSSION SESSION 01: COVID VACCINES & IMMUNOLOGY

Irini Eleftheriou, Nikos Spyridis, Lydia Kossiva, Olga Vougiouka, Maria Tsolia, [Despoina Maritsi](#)
National and Kapodistrian University of Athens, Second Department Of Pediatrics, Athens, Greece

Backgrounds: Data are scarce on the nature of breakthrough infections in children following vaccination with mRNA SARS-COV-2 vaccines , especially those with rheumatic diseases (RD).

Methods: This is a prospective, observational study conducted in the second largest pediatric hospital of the country and a reference centre for children with COVID-19 from the age-appropriate release of the (BNT 162b2) mRNA COVID-19 vaccine (May 2021/16-21 years and September 2021/11-15 years of age) until December 31st, 2021. We aimed to monitor breakthrough infections in children aged <18 years old with RD on systemic treatment after the completion of the two-dose vaccination scheme.

Results: By November 2021, 249 patients had completed their two-dose vaccination scheme. None of the patients was infected in between the two doses. However, 29 (11.6%) patients experienced SARS-CoV-2 infection following completion of the vaccination. Diagnosis was confirmed by RT-PCR in all individuals. Mean time from last dose to disease onset was 79.4 days (SD+/- 43.2). All patients were advised to avoid immunosuppressive treatment during acute illness or for a week if asymptomatic. Five patients were asymptomatic (tested due to infection exposure) while the rest presented with common symptoms. One required hospitalization due to dehydration, none required PICU admission. No RD relapse was noted. Mean anti-spike-SARS-COV-2-IgG concentration measured simultaneously at disease onset was 234 iU/ml (SD+/-143). There was no association noted between level of antibody protection, age, disease type or medication received and symptomatic disease.

Conclusions/Learning Points: Although patients with RD mount a significant anti-spike-SARS-COV-2-IgG antibody response, infection is not fully avoidable. If the third dose would have rendered these patients fully shielded against SARS-COV-2 or whether previous vaccination warranted protection against a more severe COVID-19 course are questions that remain to be answered.

PD054 / #1099

MANAGEMENT AND CLINICAL OUTCOMES OF SARS-COV-2 INFECTION IN CHILDREN WITH CANCER: A NARRATIVE REVIEW AND COHORT STUDY FROM A COVID-19 PEDIATRIC REGIONAL HUB CENTER.

E-Posters

POSTER DISCUSSION SESSION 01: COVID VACCINES & IMMUNOLOGY

Federica Pagano¹, Alfredo Diana¹, Cristina Pisano¹, Liana Punzi², Francesco Nunziata¹, Marco Poeta¹, Alfredo Guarino¹, Andrea Lo Vecchio¹, Eugenia Bruzzese¹

¹University of Naples, Federico II, Department Of Translational Medical Sciences - Section Of Pediatrics, Naples, Italy, ²University of Naples, Federico II, Department Of Translational Medical Sciences - Section Of Pediatrics, naples, Italy

Backgrounds: Many concerns have been raised about risks of SARS-CoV-2 infection in children with cancer, regarding possible severe infections as a consequence of ongoing chemotherapy and their immunosuppressant effect. As already available reports offer contrasting scenarios, varying from mainly benign infections to high percentage of critic disease, we decided to review up-to-date literature and to present data obtained in a cohort of patients followed up in tertiary care centers and specifically observed in pediatric Covid Hub.

Methods: We searched Pubmed and performed a narrative review about SARS-CoV-2 infection in children with cancer. We started a prospective data collection on demographic and disease characteristics, therapeutic management and clinical outcomes; enrollment is presently ongoing. Primary endpoints were death and severe infection. Secondary endpoints were need for oxygen therapy, intensive care and anticancer treatment schedule modification.

Results: Sixteen articles were included in the review. A systematic review published in January 2021 (n=226) reports 48% asymptomatic/mild infections and 32% patients with oxygen requirements; deaths due to COVID-19 were 4.9%. We reported SARS-CoV-2 infection in 13 patients (median age 118 months, IQR 57-143); average infection length was 37.8 days. Ten children (76.92%) had a former diagnosis of solid cancer and three of leukemia (23.08%). Regarding SARS-CoV-2 infection, nine patients (69%) were asymptomatic, three (23.08%) had mild symptoms, one (7.69%) needed anticancer treatment modification; only one patient (7.69%) had severe infection, needed oxygen therapy and anticancer treatment suspension; no one needed intensive care or died.

Conclusions/Learning Points: According to formerly available literature, SARS-CoV-2 infection in children with cancer has higher severity, morbidity and mortality compared to general pediatric population. In our cohort, we found higher incidence of asymptomatic/mild disease. Factors linked to presentation variability need further analysis.

A SYSTEMS VACCINOLOGY APPROACH OF THE BNT162B2 MRNA VACCINE RESPONSE: RESULTS OF A PILOT STUDY IN HEALTH CARE PROFESSIONALS

E-Posters

POSTER DISCUSSION SESSION 01: COVID VACCINES & IMMUNOLOGY

Ioanna Papadatou^{1,2}, Maria Geropeppa³, Theano Lagousi³, Marianna Tzanoudaki⁴, Kleio Verrou⁵, Petros Sfikakis⁵, Vassiliki Spoulou^{1,2}

¹Aghia Sophia Children's Hospital, Immunobiology And Vaccine Research Lab, Athens, Greece, ²"Agia Sophia" Children's Hospital, First Department Of Pediatrics, Athens, Greece, ³Aghia Sophia Children's Hospital, Immunobiology And Vaccine Research Lab, βουλιαγγμενη, Athens, Greece, ⁴Specific Reference Centre for Primary Immunodeficiencies-Paediatric Immunology, "Aghia Sophia" Children's Hospital, Department Of Immunology & Histocompatibility, Athens, Greece, ⁵National and Kapodistrian University of Athens, 5. center Of New Biotechnologies & Precision Medicine, Athens, Greece

Backgrounds: The development of mRNA vaccines has played a crucial role in controlling the world-wide SARS-CoV-2 pandemic, with up to 95% efficacy in preventing severe COVID-19. However, the immunity conferred is short-lived and the mechanisms involved in the development of robust immune responses to mRNA vaccines are still unclear. Here we used a systems vaccinology approach to comprehensively profile the immune response of 20 healthy volunteers to the Pfizer-BioNTech mRNA vaccine (BNT162b2).

Methods: 20 healthcare professionals 28-65y.o. were immunized with 2 doses of BNT162b2 and blood samples for mRNA, Spike(S)-protein-specific memory T cells (MTCs) and Receptor Binding Domain (RBD)-specific antibodies were drawn before the 2nd dose (Day 0), on Day 2 & Day 21 post 2nd dose. Total RNA was isolated from whole blood, using Tempus™ Spin RNA Isolation Kit. 3' mRNA next-generation sequencing-based genome-wide transcriptional profiling was performed, followed by analysis of differential expression signatures. For the enumeration of MTCs, SARS-CoV-2 S-protein PepTivator® (Miltenyi)-stimulated PBMCs were stained with CD3, CD4, CD8, IFN-γ, TNF-α, CD14, CD20, CD154, CCR7 & CD45RA and analysed in a 8-laser Navios Flow Cytometer.

Results: Differential expression analysis showed that among the total of 407 statistically significant genes with a p-value ≤ 0.05, 364 were not differentially expressed, 9 were down-regulated and 34 genes were up-regulated, consisting mainly of genes involved in antiviral pathways of innate immunity and specifically of the type-I interferon signaling pathway. When stratified by post-2nd dose antibody responses, high-responders demonstrated a predominant upregulation of ISG15, IFI6 and IFIT3 genes. Spike-protein specific T-helper cells (CD3+CD4+CD154+) and Spike-protein-specific MTCs (CD3+CD4+CD154+CD45RA-) increased significantly on Day 21 (mean values 284.1 vs 550.0 cells/ml, p < 0.01 and 276.3 vs 424.7 cells/ml, p < 0.01) respectively. RBD-specific antibodies increased significantly on Day 21. Antibody titers on Day 0 were positively correlated with Spike-specific T-helper cells and MTCs on Day 21.

Conclusions/Learning Points: This study demonstrates the induction of both the innate and adaptive immunity in response to the BNT162b2 mRNA vaccine. A secondary dose enhanced the innate response and enriched SARS-CoV-2-specific immunological memory. Individuals with high antibody responses demonstrated an enhanced interferon-stimulated gene response and increased potential for immunological memory against SARS-CoV-2.

PD056 / #1551

SARS-COV-2 NEUTRALIZING ANTIBODY IN CHILDREN AFTER 12 MONTHS FROM ACUTE INFECTION

E-Posters

POSTER DISCUSSION SESSION 01: COVID VACCINES & IMMUNOLOGY

Emma Longoni¹, Marta Stracuzzi¹, Gabriella Guida¹, Claudia Vanetti², Daria Trabattoni³, Niccolò Garancini¹, Mario Clerici⁴, Gian Vincenzo Zuccotti⁵, Vania Giacomet¹

¹Università degli Studi di Milano, Pediatric Infectious Disease Unit, Luigi Sacco Hospital, Milano, Italy, ²Università degli studi di Milano, Chair Of Immunology - Department Of Pathophysiology And Transplantation, Milan, Italy, ³Università degli studi di Milano, Department Of Biomedical And Clinical Sciences "Luigi Sacco", Milan, Italy, ⁴Università degli studi di Milano and IRCCS Fondazione Don Carlo Gnocchi, Department Of Pathophysiology And Transplantation, Milan, Italy, ⁵Università degli studi di Milano, Department Of Pediatrics, V. Buzzi Children's Hospital, Department Of Biomedical And Clinical Sciences "I. Sacco" And Pediatric Clinical Research Center "Romeo Ed Enrica Invernizzi", Milan, Italy

Backgrounds: Exhaustive reports on specific immune responses to SARS-CoV-2 in paediatric patients remain scarce, posing an unprecedented challenge to clinicians. The present study aims to characterize the SARS-CoV-2 Neutralizing antibody titer in a cohort of SARS-CoV-2-infected children at different ages after 12 months of SARS-CoV-2 acute infection.

Methods: We conducted a multicenter prospective analysis of clinical record and blood samples of SARS-CoV-2 infected children at Luigi Sacco Hospital and Vittore Buzzi Hospital, Milan, Italy. From February 21st, 2020 to May 1st, 2020, subjects aged less than 18 years with a documented history of SARS-CoV-2 were included. SARS-CoV-2 neutralization assay was used to evaluate neutralizing antibodies (Nab) responses on a blood sample collected after 12 months after SARS-CoV-2 infection. Data about COVID-19 vaccination state were collected.

Results: Seventeen children were included. Three out of 17 were vaccinated at time of samples collection. Maximum amount of Nab (1280) is found in the vaccinated subjects; no one of not vaccinated reaches similar values, whose maximum value is 320. Nab average in our cohort is 330; this value is destined to decrease to 90,3 if we do not consider vaccinated subjects. Higher amounts of Nab were detected in vaccinated subjects compared with not vaccinated respectively, indicating an increased humoral response after SARS-CoV-2 vaccine. No significant differences were found among SARS-CoV-2 Nab in different class ages (preschooler children, schooler children, adolescent); we found an increasing trend from younger to older, that was not maintained if we not considered vaccinated subjects.

Conclusions/Learning Points: Our data suggest a difference in Nab according to vaccination status, in children with history of COVID-19. Correlations to class ages deserves to be further investigated in larger cohort studies.

PD057 / #1536

ANTIBODY RESPONSE EVALUATION IN SARS-COV-2 IMMUNIZED MOTHERS AND BABIES AT BIRTH.

E-Posters

POSTER DISCUSSION SESSION 01: COVID VACCINES & IMMUNOLOGY

Arianna Pani¹, Alice Proto², Stefano Agliardi¹, Oscar Matteo Gagliardi¹, Silvia Renica¹, Federica Di Ruscio¹, Chiara Vismara³, Daniela Campisi³, Francesco Scaglione¹, Stefano Martinelli²

¹Università degli Studi di Milano, Department Of Oncology And Hemato-oncology, Milan, Italy, ²Niguarda Hospital, Neonatology And Neonatal Intensive Care Unit, Milan, Italy, ³Niguarda Hospital, Microbiology Unit, Milan, Italy

Backgrounds: Pregnant women and newborns are subject to greater risk of severe disease and mortality compared to nonpregnant adults when infected with SARS-CoV2. SARS-CoV2 vaccination have demonstrated to be safe in pregnancy. However, there are no guidelines regarding timing of COVID-19 vaccination timing during gestation. The aim of our analysis is to understand the correlation between timing of vaccination and mother and children antibody titer at the time of birth.

Methods: Participants were recruited at the Niguarda Hospital, of Milan, from May to November 2021. We included mothers having received Pfizer/BioNTech and Moderna vaccines during pregnancy. Serological IgG antibodies anti-S1 RBD were evaluated through a quantitative chemiluminescent-assay (Abbott). Data regarding timing of vaccination were obtained.

Results: 84 subjects were included in the analysis. 22 mothers out of 84 received just one dose, while 62 received two doses. The geometric mean titer (GMT) of anti-S IgG is 571.8 (7.4) AU /ml for mothers (%CV 247) and 329.2 (7.6) AU/ml for babies (%CV 280) in the group of subjects who received just one dose. In the group of those who received two doses the GMT was 5480.5 (2.7) AU/ml for mothers (%CV109) and 6271.7 (2.7) AU/ml for babies (%CV 101). The correlation between the gestational age and the serological titer at birth of the newborn is significant in the 62 mothers with 2 doses ($p < 0.001$): the higher the gestational age when mothers received vaccination the higher is the serological titer at birth (tobit mixed models regression).

Conclusions/Learning Points: Our data suggest that children of mothers who received two doses of vaccine maintain at birth a titer equal or higher than the mothers' titer and a correlation between gestational age at the vaccination and titer at birth.

HUMORAL AND CELLULAR IMMUNE RESPONSE TO MRNA SARS-COV-2 BNT162B2 VACCINE IN ADOLESCENTS WITH RHEUMATIC DISEASES

E-Posters

POSTER DISCUSSION SESSION 01: COVID VACCINES & IMMUNOLOGY

Clara Udaondo¹, Carmen Camara², Laura Miguel Berenguel², Rosa Alcobendas¹, Celia Muñoz Gomez¹, Claudia Millan-Longo¹, Blanca Diaz Delgado¹, Iker Falces³, Mariana Diaz Almiron⁴, Jordi Ochando⁵, Ana Méndez-Echevarría⁶, Agustin Remesal¹, Cristina Calvo⁶

¹Hospital Universitario la Paz, Paediatric Rheumatology, Madrid, Spain, ²Hospital Universitario La Paz, Immunology, Madrid, Spain, ³Hospital Universitario La Paz, Microbiology And Parasitology, Madrid, Spain, ⁴Hospital Universitario La Paz, Institute Of Biomedical Research (idipaz),, Madrid, Spain, ⁵Instituto de salud Carlos III, Microbiology, Madrid, Spain, ⁶Hospital La Paz, Pediatric Infectious Diseases, Madrid, Spain

Backgrounds: Immunosuppressive treatments for rheumatic diseases (RD) could interfere with vaccine response. Cellular response to the mRNA SARS-CoV-2 vaccine in adolescents with rheumatic diseases (RD) remains unknown. We aimed to evaluate efficacy of the BNT162b2 vaccine in adolescents with RD and immunosuppressive treatment compared with a control group.

Methods:: Adolescents from 12 to 18 years with RD followed at a reference hospital (n=40) and non-RD adolescents (n=24) receiving BNT162b2 mRNA vaccine were assessed 3 weeks after complete vaccination. The humoral response was measured by total antiSpike antibodies, and cellular response by IFN- γ and IL-2 in blood stimulated with SARS-CoV-2 Spike and M proteins.

Results: There were no differences in humoral or cellular response between groups (median IFN- γ response; 529 pg/ml in controls vs. 398 in RD patients, p 0.78, and median IL-2 in controls: 636 pg/ml vs. 497 in RD patients, p 0.22). The most frequent diagnosis was juvenile idiopathic arthritis (26/40, 65%) followed by Lupus (6/40, 15%). 60% of cases (23/40) received Tumour Necrosis Factor Inhibitors and 35% (14/40) methotrexate. 40% of patients (26/64) had previous SARS-CoV-2 infection, 9 controls and 17 RD patients without differences. 70% of infections were asymptomatic. COVID-19 recovered individuals had higher IFN- γ response than naïve subjects in both groups (controls: median 859 pg/ml in recovered vs. 450 in naïve p 0.017, RD patients: 850 vs. 278 p 0.024). No serious adverse events or flares were reported following vaccination.

TABLES

Table 1. Demographic characteristics of patients with rheumatic diseases and controls

| | Global | Controls | Adolescents with RD | <i>p</i> |
|---------------------|--------------|--------------|---------------------|----------|
| n | 64 | 24 | 40 | |
| Age (median, range) | 14 (12 – 16) | 13 (12 – 14) | 14 (13 – 16) | 0.07 |
| Sex | | | | |
| Female n (%) | 34 (53%) | 12 (50%) | 22 (55%) | 0.79 |

Description of patients with rheumatic diseases:

| Diagnosis n (%) | |
|-----------------------------|------------|
| JIA | 26 (65%) |
| joSLE | 6 (15%) |
| Uveitis | 3 (7.5%) |
| JDM | 1 (2.5%) |
| Juvenile Systemic sclerosis | 1 (2.5%) |
| Crohn's disease | 1 (2.5%) |
| Behçet's disease | 1 (2.5%) |
| HA20 | 1 (2.5%) |
| Treatment n (%) | |
| Adalimumab | 11 (27.5%) |
| Etanercept | 9 (22.5%) |
| Infliximab | 3 (7.5%) |
| Mycophenolate | 5 (12.5%) |
| Baricitinib | 5 (12.5%) |
| Tocilizumab | 1 (2.5%) |
| Cyclosporine | 1 (2.5%) |
| None of the above | 5 (12.5%) |
| Methotrexate | 14 (35%) |
| Disease Activity n (%) | |
| Inactive disease (VASc = 0) | 26 (65%) |
| Active disease (VASc > 0) | 14 (35%) |

JIA: Juvenile Idiopathic Arthritis, joSLE: Juvenile Onset Systemic Lupus Erythematosus, JDM: Juvenile Dermatomyositis, HA20: Haploinsufficiency A20. VASc: Visual Analogue Scale – clinician.

Table 2. Previous COVID-19 infection

| | Global | Controls | Adolescents with RD | <i>p</i> |
|---|-------------|------------|---------------------|----------|
| Reported COVID-19 infection SARS-CoV-2 + PCR n (%) | 8 (13%) | 4 (18%) | 4 (10%) | |
| Demonstrated COVID-19 infection IFN- γ M cellular response n (%) | 24 (42%) | 8 (34%) | 16 (40%) | 0.78 |
| SARS-CoV-2 + PCR with negative IFN- γ M response (n) | 2 | 1 | 1 | |
| Global SARS-CoV-2 infection | 26/64 (40%) | 9/24 (37%) | 17/40 (42%) | |
| Previously unknown SARS-CoV-2 infection n (%) | 18/26 (70%) | 5/9 (55%) | 13/17 (76%) | |

Table 3. Humoral and Cellular response against the mRNA BNT162b2 vaccine in adolescents with RD and controls

| | Controls | | | Adolescents with RD | | | <i>p</i> |
|--|-----------------|--------------------|----------|---------------------|--------------------|----------|----------|
| IFN- γ (pg/mL, median, range) | 529 (288 – 935) | | | 398 (209 – 1025) | | | 0.78 |
| IL-2 (pg/mL, median, range) | 636 (265 – 834) | | | 497 (339 – 611) | | | 0.22 |
| SARS-CoV-2 IgG antibodies > 10 index (%) | 23/24 (96%) | | | 38/40 (95%) | | | |
| | Naive | COVID-19 recovered | <i>p</i> | Naive | COVID-19 recovered | <i>p</i> | |
| IFN- γ (pg/mL, median, range) | 450 (229 – 708) | 859 (412 – 1452) | 0.017 | 278 (202 – 784) | 849 (342 – 1526) | 0.024 | |
| IL-2 (pg/mL, median, range) | 398 (255 – 571) | 592 (490 – 705) | 0.036 | 632 (255 – 794) | 675 (364 – 1048) | 0.28 | |

Conclusions/Learning Points: Standard of care treatment for adolescents with RD did not affect the humoral and the cellular immunity to BNT162b2 mRNA vaccination suggesting that no treatment discontinuation or additional dosing would be required compared to healthy adolescents. Previous SARS-CoV-2 infection was the most relevant factor in the immune response.

GETTING THE DIAGNOSIS RIGHT IN CHILDHOOD TB: CLINICAL AND MICROBIOLOGICAL CHARACTERISTICS AMONG CHILDREN RECRUITED IN “RAPAED-TB”

E-Posters

POSTER DISCUSSION SESSION 02: GLOBAL HEALTH & TB

Laura Olbrich^{1,2}, Zoe Franckling-Smith³, Heather Zar⁴, Issa Sabi⁵, Nyanda Ntinginya⁵, Celso Khosa⁶, Denise Banze⁶, Marriott Nliwasa⁷, Elizabeth Corbett^{7,8}, Robina Semphere⁷, Valsan Verghese⁹, Joy S Michael¹⁰, Stephen Graham¹¹, Rinn Song¹², Pamela Nabeta¹³, Andre Trollip¹³, Mohammed Ahmed¹, Kathrin Held¹, Christof Geldmacher¹, Michael Hoelscher¹, Norbert Heinrich¹⁴

¹Ludwig-Maximilians University, Division Of Infectious Diseases And Tropical Medicine, University Hospital, Munich, Germany, ²University of Oxford, Oxford, Oxford Vaccine Group, Department Of Paediatrics, Oxford, United Kingdom, ³SA-MRC Unit on Child & Adolescent Health, University of Cape Town, Department Of Paediatrics & Child Health, Cape Town, South Africa, ⁴Red Cross Children's Hospital, Department Of Paediatrics And Child Health, Cape Town, South Africa, ⁵Mbeya Medical Research Centre, National Institute For Medical Research -, Mbeya, Tanzania, ⁶Instituto Nacional de Saúde (INS), Instituto Nacional De Saúde, Marracuene, Mozambique, ⁷College of Medicine, Tb/hiv Research Group, Blantyre, Malawi, ⁸London School of Hygiene and Tropical Medicine, Tb Centre, London, United Kingdom, ⁹Christian Medical College (CMC), Pediatric Infectious Diseases, Department Of Pediatrics, Vellore, India, ¹⁰Christian Medical College (CMC), Department Of Clinical Microbiology, Vellore, India, ¹¹University of Melbourne, Centre For International Child Health, Melbourne, Australia, ¹²Oxford Vaccine Group, University of Oxford, Oxford, UK, Department Of Paediatrics, Oxford, United Kingdom, ¹³Foundation for Innovative New Diagnostics, Foundation For Innovative New Diagnostics, Geneva, Switzerland, ¹⁴Division of Infectious Diseases and Tropical Medicine, University Hospital, Lmu, Munich, Germany

Backgrounds: Microbiological detection remains the reference standard for paediatric TB but is rarely achieved. Novel more sensitive diagnostic tests are sought as much as optimised sampling strategies.

Methods: RaPaed-TB was multi-centre prospective diagnostic validation study performed in India, Malawi, Mozambique, Tanzania and South Africa. Children (<15 years) with Presumptive TB provided at least two (induced) sputum samples at enrolment, one stool sample, and one nasopharyngeal aspirate if <5 years. TB testing included PCR and culture; diagnostic classification followed NIH-consensus statements. Data cleaning is underway, presented results are preliminary.

Results: In total, 974 participants were enrolled. At time of writing, sufficient information for diagnostic classification was available for 732 children. Out of the 32.0% (234/732) with confirmed TB, 46.6% (109/234) were confirmed by both culture and PCR, 36.3% (85/234) solely by PCR, and 17.1% (40/234) by culture only. 36.2% (265/732) were clinically diagnosed with TB, and 31.8% (233/732) were deemed unlikely TB. Overall, 46.4% (340/732) were <5 years of age and 16.2% (117/724) were HIV-coinfected. Children with confirmed and unconfirmed TB were more likely to be underweight, and most frequent symptoms were cough (82.1%), fever (66.4%), and unexplained weight loss (58.2%). Regression analyses were performed to identify clinical and demographic covariates associated with TB diagnosis (confirmed vs unlikely TB), demonstrating a strong association of TST-positivity (OR 6.36, p<0.0001) and abnormal chest radiography (OR 2.57, p=0.005) in the multivariate model. Further analyses are ongoing, and results are to be presented.

Conclusions/Learning Points: RaPaed-TB allows for an in-depth description of clinical and demographic characteristics of a well characterised diagnostic validation cohort. With a high number of microbiologically confirmed children, meaningful subgroup description and new test analyses will be possible in this geographically diverse cohort.

PREVALENCE OF RICKETTSIA CONORII AND RICKETTSIA TYPHI INFECTIONS IN POPULATION IN EUROPE: A SYSTEMATIC REVIEW AND META-ANALYSIS

E-Posters

POSTER DISCUSSION SESSION 02: GLOBAL HEALTH & TB

Evangelia Sarikloglou¹, Eleni Kourkouni², Georgia Kourlaba³, Maria Tsolia⁴

¹Democritus University of Thrace, Pediatric Department, Alexandroupolis, Greece, ²Center for Clinical Epidemiology and Outcomes Research (CLEO), Non-profit Civil Partnership, Athens, Greece, ³Econcare, Rwe & Hta Consultant, Athens, Greece, ⁴National and Kapodistrian University of Athens, Second Department Of Pediatrics, "p. & A. Kyriakou" Children's Hospital, Athens, Greece

Backgrounds: Rickettsia conorii and Rickettsia typhi are the etiologic agents of Mediterranean spotted fever and murine typhus, respectively. These gram-negative bacteria are recognized as causes of fever of intermediate duration in Europe. Nevertheless, these febrile diseases can be easily misdiagnosed, due to their non-specific presentation. Furthermore, limited data exist regarding the actual prevalence of past infection due to these two pathogens. The aim of the present systematic review and meta-analysis was to evaluate all available data in the literature regarding the prevalence of past infection due to Rickettsia conorii and Rickettsia typhi in population in Europe. Being aware of the prevalence of these two febrile diseases in Europe, will help clinicians suspect the diagnosis even in cases presenting with no specific initial symptoms.

Methods: Articles from PubMed database were systematically reviewed up to September 2019. Only seroepidemiological serosurveys studies in population in Europe were eligible for inclusion, when full text was available in English. IgG antibodies against Rickettsia conorii and Rickettsia typhi detected by means of immunofluorescence assay. Data were extracted and statistically analyzed. Random effects models were used to synthesize data. Heterogeneity and publication bias were evaluated. The analysis was performed with the statistical package STATA SE.

Results: Of 814 citations retrieved, 17 seroepidemiological serosurvey studies in Europe were included. These studies detected IgG antibodies against Rickettsia conorii and Rickettsia typhi. The cumulative prevalence of Rickettsia conorii and Rickettsia typhi in all studies was estimated at 12% (95% CI: 5%-21%) and 6% (95% CI: 2%-11%), respectively. The percentage of heterogeneity of the studies was very high >90%.

Conclusions/Learning Points: The results of this meta-analysis indicate that physician's awareness of these zoonotic diseases should be increased, as both remain a significant health problem in Europe.

PD061 / #921

IMPORTED PEDIATRIC MALARIA IN BRUSSELS. A STUDY ON 160 MALARIA AFFECTED CHILDREN

E-Posters

POSTER DISCUSSION SESSION 02: GLOBAL HEALTH & TB

Valbona Selimaj Kontoni¹, Tessa Goetghebuer², Phuong Nguyenvoethanh³, Marc Hainaut²

¹Clinique Saint Jean, Paediatric Infectious Diseases, Brussels, Belgium, ²CHU Saint Pierre, Department Of Infectious Diseases, Brussels, Belgium, ³Laboratoires Hospitaliers Universitaires de Bruxelles, Department Of Hematology, Brussels, Belgium

Backgrounds: Malaria is a major global public health problem. Imported childhood malaria is rising in the malaria non-endemic countries. We describe the main epidemiological, clinical and laboratory characteristics of children 0-15 years old with malaria in the city of Brussels.

Methods: Retrospective case review of all laboratory confirmed malaria for children admitted between 2009-2019.

Results: A total of 160 children with a median age of 6,8 years (range 5-191 months) were identified. There were 111 (69%) Belgian based children that acquired malaria during their visit to malaria-endemic country to visit friends and relatives, and 49 children were visitors to Belgium (15 or newly installed immigrants). Among the travellers to the malaria-endemic areas 99% were of African ethnicity. The incidence of malaria rates increased during the study period. The peak seasonal incidence was during the months of August-September. Plasmodium falciparum was responsible for 89% of the malaria cases. Almost 80% of the Belgian based children visited the travel clinic for advice, but only one third of them reported to have taken the prophylaxis scheme according to the recommendations. One fifth of the patients had seen one or more physicians prior to malaria diagnosis. Based on the WHO criteria approximately one fifth of the total number of children 31 (19.3%) developed severe malaria including coma (n=2); alteration of neurologic status (n=6), convulsions (n=1); severe acidosis (n=1) severe anaemia (n= 3); jaundice (n=1); parasitaemia (n=17).

Conclusions/Learning Points: Malaria is a significant cause of morbidity in returning travellers and newly arrived immigrants to Belgium. The majority of the children had an uncomplicated course of disease and all children fully recovered. Physicians should educate families travelling to malaria-endemic areas on the correct malaria preventive measures and prophylaxis.

PD062 / #1434

DIFFERENTIAL BURDEN OF POST-EBOLA SYNDROME SYMPTOMS IN CHILDREN, ADOLESCENTS AND YOUNG ADULTS.

E-Posters

POSTER DISCUSSION SESSION 02: GLOBAL HEALTH & TB

Nell Bond¹, Emily Engel², Lansana Kanneh³, Robert Samuels⁴, Donald Grant⁴, John Schieffelin⁵

¹Tulane University School of Medicine, Microbiology & Immunology, New Orleans, United States of America, ²Tulane University, Microbiology & Immunology, New Orleans, United States of America, ³Kenema Government Hospital, Viral Hemorrhagic Fever Project, Kenema, Sierra Leone, ⁴Kenema Government Hospital, Pediatrics, Kenema, Sierra Leone, ⁵Tulane University, Pediatrics, Division Of Infectious Diseases, New Orleans, United States of America

Backgrounds: The 2013-2016 Ebola outbreak was the largest in history with over 28,000 cases and 11,000 deaths. A large cohort of survivors have since reported persistent, often debilitating health concerns dubbed Post-Ebola Syndrome (PES). However, attention to PES in pediatric survivors is lacking. Here we describe differences in PES presentation between pediatric, adolescent, and young adult EVD survivors in Eastern Sierra Leone.

Methods: EVD survivors were enrolled a median of 2.5 years after resolution of disease. Survivors were eligible if listed in a national register maintained by the Sierra Leone Association of Ebola Survivors. Participants were assigned into three comparison groups: pediatric (7-11), adolescent (12-17) and young adult (18-25). A self-reported symptom questionnaire querying 47 variables, and a physical exam querying 77 variables were conducted. Variables were clustered within organ system and compared across groups.

Results: We found that pediatric survivors had lower levels of long-term sequelae compared to adolescents and young adults. Across all variables tested, symptoms and abnormal physical exam signs increased with age. 14.8% of symptoms and 7.8% of physical exam signs were significantly different between groups. Of note, discrete musculoskeletal, psychiatric, ophthalmologic, and gastro-intestinal signs and symptoms were significantly different between groups. Interestingly, both pediatric and adolescent survivors were less likely to have signs and symptoms within the psychiatric/neurological cluster compared to young adults ($p < .001$).

Conclusions/Learning Points: In this study we show that EVD survivors of all ages suffer from long-term sequelae associated with PES 2.5 years after recovery. PES is heterogeneous with respect to age indicating that a deeper understanding of age-based differences in PES presentation is needed. Understanding the mechanisms behind these differences in symptom burden will ultimately lead to improved, targeted treatments for EVD survivors suffering from

PES.

PES Symptom Clusters by Age

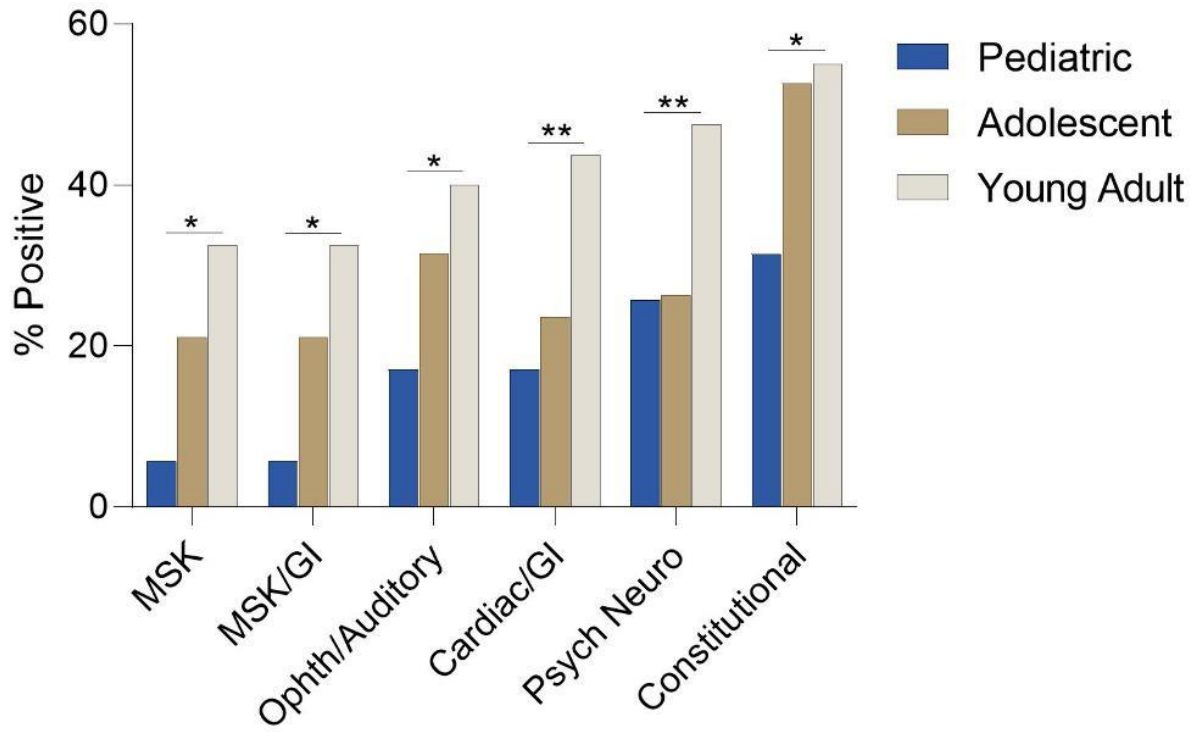

EVALUATION OF DIFFERENT RESPIRATORY SAMPLES FOR TUBERCULOSIS DIAGNOSIS IN CHILDREN FROM A HIGHLY ENDEMIC AREA (CUBAL, ANGOLA)

E-Posters

POSTER DISCUSSION SESSION 02: GLOBAL HEALTH & TB

Natalia Mendoza-Palomar¹, María Teresa Tórtola², Olalla Rodríguez³, Elena Sulleiro-Igual², Arlete Nindia⁴, Nicolau Sicaleta⁵, Milagros Nicasio⁵, Cristina Bocanegra⁶, Maria Espiau⁷, Antoni Soriano-Arandes⁷

¹Hospital Universitari Vall d'Hebron, Pediatric Infectious Diseases And Immunodeficiencies Unit, Barcelona, Spain, ²Hospital Universitari Vall d'Hebron, Microbiology Department, Barcelona, Spain, ³Hospital Universitari Vall d'Hebron, Emergency Department, Barcelona, Spain, ⁴Hospital Nossa Senhora da Paz, Microbiology Department, Cubal, Angola, ⁵Hospital Nossa Senhora da Paz, Pediatrics Department, Cubal, Angola, ⁶Hospital Universitari Vall d'Hebron, Infectious Diseases Department, Barcelona, Spain, ⁷Hospital Universitari Vall d'Hebron, Pediatric Infectious Diseases And Immunodeficiencies Unit, barcelona, Spain

Backgrounds: Diagnosis of tuberculosis (TB) in children is challenging due to their low bacillary load and difficulties to produce sputum. Traditionally, gastric lavage (GL) has provided an alternative sample, but new molecular techniques could facilitate the use of less invasive samples as nasopharyngeal aspirate (NPA). We aimed to compare the yield of different samples for the microbiological diagnosis of pulmonary TB.

Methods: Children (0-15 years) clinically diagnosed of pulmonary TB (Graham et al. criteria) in Hospital Nossa Senhora da Paz (Cubal, Angola) were included. Sputum or alternatively paired samples of GL and NPA were collected. Acid-fast bacilli (AFB) smear exam and Mycobacterium tuberculosis molecular detection with Xpert MTB/Rif assay was performed in all samples. Both tests, along with culture, were repeated six months later in Hospital Universitari Vall d'Hebron (Barcelona, Spain).

Results: Ninety-one patients were included, 55% male, median age 2 (IQR 1-5) years. Eighty-two percent presented moderate-severe malnutrition, 3 HIV-positive. 6/17 sputum samples yielded positive results (6 microscopy/5 Xpert MTB/Rif assay, 1 rifampicin-resistant), while 6/66 GL (5 microscopy/6 Xprt MTB/Rif assay) and 6/66 (5 microscopy/4 Xpert MTB/Rif assay) NPA were positive. 8 patients didn't have microbiological samples. Concordance between GL and NPA was good (kappa coefficient 0,64). Repeated tests in Spain were only positive for one sputum sample (microscopy and Xpert MTB/Rif assay). All cultures were negative.

Conclusions/Learning Points: Despite the relatively low number of positive results, diagnostic efficiency of NPA was similar to GL. In contrast, sputum showed the highest diagnostic yield. The negativity of the repeated tests could be explained by transport factors and a scarce and unequally distribution bacillary load. Besides the addition of molecular techniques, new strategies are needed to improve TB diagnosis in children.

GIARDIA LAMBLIA INFECTION IN PEDIATRIC HEART TRANSPLANT PATIENTS

E-Posters

POSTER DISCUSSION SESSION 02: GLOBAL HEALTH & TB

Shirin Sayyahfar¹, Khadijeh Khanaliha², Mohammad Mahdavi³, Mahsa Mozaffari⁴

¹Research Center of Pediatric Infectious diseases, Institute of Immunology and Infectious Diseases, School of Medicine, Iran University of Medical Sciences, Tehran, Iran, Pediatrics, Tehran, Iran, ²Research Center of Pediatric Infectious diseases, Institute of Immunology and Infectious Diseases, School of Medicine, Iran University of Medical Sciences, Tehran, Iran, Parasitology, Tehran, Iran, ³Department of Pediatric Cardiology, Rajaie Cardiovascular Medical and Research Center, School of Medicine, Iran University of Medical Sciences, Tehran, Iran, Pediatric Cardiology, Tehran, Iran, ⁴School of medicine, Iran University of Medical Sciences, Tehran, Iran, Pediatrics, Tehran, Iran

Backgrounds: Giardiasis is one of the opportunistic infections in immunocompromised patients, especially organ transplant recipients. Regarding to the importance of this issue, the aim of this study was to investigate the Giardia lamblia infection status in children with heart transplantation.

Methods:: A cross-sectional study was conducted on 53 cardiac transplant recipients (aged 1–17 years). Transplant patients were on oral Trimethoprim / Sulfamethoxazole (TMP-SMX) regimen from the first day of transplantation as a prophylaxis regimen. Giardia lamblia status was evaluated by phenotypic assay and Polymerase chain reaction (PCR) on stool samples.

Results: Out of 53 patients studied, 11 (20.75%) cases had gastrointestinal and 42 (79.25%) patients had no gastrointestinal symptoms. There was no significant difference in the frequency of underlying disorder resulted in heart transplantation in two groups ($p = 0.13$). The frequency of Giardia lamblia infection was 3 (27.27%) in the symptomatic group and zero in the asymptomatic group ($p < 0.0001$). All three patients whose stool exams were phenotypically positive for Giardia were confirmed with PCR. Out of three, Two Giardia lamblia isolates were found to have genotype B while one isolate had genotype A. All of the Giardia positive patients suffered from chronic diarrhea and anorexia. Cryptosporidium spp, Isospora belli and Blastocysts spp were not found in these cases.

Conclusions/Learning Points: Incidence of Giardia lamblia infection in pediatric heart transplant patients may be considerable and should be noted. A comprehensive guideline for assessment of Giardia lamblia before and after transplantation is suggested.

PD065 / #1828

A MYCOBACTERIUM BOVIS CATASTROPHE

E-Posters

POSTER DISCUSSION SESSION 02: GLOBAL HEALTH & TB

Helen Groves¹, Marty Hanna¹, Louise Mccorry², Paul Moriarty¹, Sharon Christie¹, Lynne Speirs¹

¹Royal Belfast Hospital for Sick Children, Paediatrics, Belfast, United Kingdom, ²Royal Victoria Hospital, Infectious Diseases, Belfast, United Kingdom

Title of Case: A Mycobacterium bovis CATastrophe

Background: Mycobacterium bovis (M. bovis) can cause zoonotic tuberculosis in humans. In the UK approximately 30-35 human cases of M. bovis occur annually. Infections are mainly attributed to reactivation of historical latent disease or to overseas acquisition. The risk of contracting M. bovis from an animal in the UK is considered extremely low.

Case Presentation Summary: We report a cluster of M. bovis cases within a single household and veterinary nurse. The initial case was a seven-year-old previously healthy girl presenting with a seizure, fluctuating consciousness level and subsequent sixth nerve palsy. CSF analysis revealed high leucocyte count (predominately lymphocytes) and MRI head revealed diffuse leptomeningeal enhancement. CSF PCR test for Mycobacterial tuberculosis complex was positive and the patient was commenced on anti-tuberculous therapy (rifampicin, ethambutol, isoniazid, pyrazinamide) and dexamethasone with gradual resolution in clinical symptoms. CSF subsequently cultured M. bovis and therapy was changed to moxifloxacin, ethambutol, rifampicin and isoniazid. Tracing of household contacts revealed all three siblings were positive on either IGRA or Mantoux testing. Two siblings demonstrated chest X-ray changes consistent with pulmonary tuberculosis necessitating active anti-tuberculous therapy and latent treatment was commenced for the remaining child. On review of exposure history, no risk factors were identified other than a pet cat recently euthanized due to severe illness and an extensive suppurating wound. No cultures from the pet were taken, however a veterinary nurse bitten by the animal developed a suppurating wound at the bite site which cultured M. bovis.

Learning Points/Discussion: This unusual cluster highlights that, although rare, transmission of M. Bovis infection from domestic cats to humans can occur. Identification of M. bovis in a domestic pet should trigger screening of close human contacts for possible infection.

CLINICAL PHENOTYPES OF INPATIENT AND OUTPATIENT CHILDREN PRESENTING WITH FEVER IN THE FEBRILE ILLNESS EVALUATION IN A BROAD RANGE OF ENDEMICITIES (FIEBRE) STUDY

E-Posters

POSTER DISCUSSION SESSION 02: GLOBAL HEALTH & TB

Sara Ajanovic Andelic¹, Elizabeth Fitchett², Núria Balanza³, Elizabeth Ashley⁴, Mabvuto Chimanya⁵, John Crump⁶, Nicholas Feasey⁷, Felicity Fitzgerald⁸, Edward Green⁵, Heidi Hopkins⁹, Katharina Kranzer¹⁰, Sham Lal⁹, Samantha Lissauer¹¹, Manophab Luangraj⁴, David Mabey⁹, Mayfong Mayxay⁴, Polycarp Mogeni⁹, Ioana-Diana Olaru⁸, Quique Bassat³, Shunmay Yeung²

¹Barcelona Institute for Global Health, Research In Epidemiology And International Health Group, Barcelona, Spain, ²London School of Hygien & Tropical Medicine (LSHTM), London, UK, Paediatrics, London, United Kingdom, ³Barcelona Institute for Global Health (ISGlobal), Research In Epidemiology And International Health Group, Barcelona, Spain, ⁴Lao-Oxford-Mahosot Hospital-Wellcome Trust Research Unit (LOMWRU), Mahosot Hospital, Vientiane, Lao PDR, Epidemiology, Vientiane, Laos, ⁵Malawi-Liverpool-Wellcome Trust Clinical Research Programme, Blantyre, Malawi, Epidemiology, Blantyre, Malawi, ⁶Centre for International Health, University of Otago, Dunedin, New Zealand, Epidemiology, Dunedin, New Zealand, ⁷Liverpool School of Tropical Medicine, Liverpool, UK, Department Of Clinical Sciences, Liverpool, United Kingdom, ⁸Biomedical Research and Training Institute, Harare, Zimbabwe, Epidemiology, Harare, Zimbabwe, ⁹London School of Hygiene & Tropical Medicine (LSHTM), London, UK, Global Health, London, United Kingdom, ¹⁰Biomedical Research & Training Institute, Research, Harare, Zimbabwe, ¹¹Malawi-Liverpool-Wellcome Trust Clinical Research Programme, Blantyre, Malawi, Epidemiology & Global Health, Blantyre, Malawi

Backgrounds: Acute febrile illness continues to drive healthcare attendances in children in Africa and South-eastern Asia. However, diagnosis of severe illness and non-malaria aetiologies that could guide targeted treatments remains challenging.

Methods:: We evaluated prospectively collected clinical data from the FIEBRE study (2018-2021) to describe the clinical phenotypes (defined by ICD-10 or WHO criteria) of a cohort of febrile infants and children aged ≥ 2 months and < 15 years in four countries. We explored the clinical utility of the WHO Integrated Management of Childhood Illness (IMCI) guidance on 'danger signs' mandating urgent intervention or referral in children ≤ 5 years.

Results: 3,718 children were enrolled (1,648 inpatients; 2,070 outpatients): 760 in Laos, 946 in Malawi, 1,136 in Mozambique and 876 in Zimbabwe. 1734 (47%) were female and 2294 (62%) were ≤ 5 years old. 100 (3%) had a reported or confirmed HIV diagnosis and 409 (11%) were severely malnourished. Of 3,196 children with complete follow-up data (≥ 28 days), 39 (2.8%) and three (0.2%) inpatient and outpatient children died, respectively. One or more IMCI danger signs or criteria for urgent intervention or referral were present in 418 (34%) outpatient and 684 (64%) inpatient children ≤ 5 years. Among 42 children who died, 13 (31%) deaths occurred in children > 5 years, in whom IMCI 'danger signs' are not validated, and seven children ≤ 5 years did not meet any of the IMCI criteria. We will present our cohort's clinical phenotypes stratified by site, age, and point-of-care test results (HIV, malaria, blood culture and urine culture).

Conclusions/Learning Points: In an era of improved overall childhood survival, better diagnostic and prognostic tools for children of all ages – including those aged 6–14 years – are required to support clinical care in high infection burden settings.

PD067 / #1838

INTERNATIONAL CHANGES IN RESPIRATORY SYNCYTIAL VIRUS (RSV) EPIDEMIOLOGY DURING THE COVID-19 PANDEMIC: ASSOCIATION WITH SCHOOL CLOSURES

E-Posters

POSTER DISCUSSION SESSION 02: GLOBAL HEALTH & TB

Marie Billard¹, Peter Van De Ven², Bianca Baraldi¹, Leyla Kragten-Tabatabaie³, Louis Bont⁴, Joanne Wildenbeest⁴

¹Wilhelmina Children's Hospital, Pediatric Infectious Diseases And Immunology, Utrecht, Netherlands, ²Julius Center for Health Sciences and Primary Care, Department Of Data Science And Biostatistics, Utrecht, Netherlands, ³Julius Clinical, -, Zeist, Netherlands, ⁴Wilhelmina Children's Hospital UMC Utrecht, Department Of Pediatric Infectious Diseases And Immunology, Utrecht, Netherlands

Backgrounds: Little RSV activity was observed during the first expected RSV season since the COVID-19 pandemic. Multiple countries later experienced out-of-season RSV resurgences, yet their association with non-pharmaceutical interventions (NPIs) are unclear. This study aimed to describe the international changes in RSV epidemiology during the COVID-19 pandemic, and to estimate the association between individual NPIs and the RSV resurgences.

Methods:: RSV activity from Week (W)12-2020 to W44-2021 was compared with three pre-pandemic seasons, using RSV surveillance data from Brazil, Canada, Chile, France, Israel, Japan, South Africa, South Korea, Taiwan, the Netherlands and the United States. Changes in nine NPI policies within 10 weeks before RSV resurgences were described. Associations between individual NPIs and RSV activity were assessed with linear mixed models. Adherence to NPIs was not taken into account.

Results: Average delay of the first RSV season during the COVID-19 pandemic was 39 weeks (range: 13-88 weeks). While the delay was <42 weeks in six countries, a missed RSV season were observed in Brazil, Chile, Japan, Canada and South Korea. School closures, workplace closures and stay-at-home requirements were most commonly downgraded before a RSV resurgence. School closures were systematically associated with lower RSV activity. Stay-at-home requirements and gathering restrictions showed weaker associations. Table 1. Characteristics of the pre-pandemic RSV seasons and first pandemic RSV season, changes in RSV epidemiology, per country

| | South Africa | Brazil | Chile | France | The Netherlands | Israel | The United States | Canada | Japan | Taiwan | South Korea |
|---|--------------|----------|----------|----------|-----------------|----------|-------------------|----------|----------|----------|-------------|
| First RSV epidemic during COVID-19 pandemic | | | | | | | | | | | |
| Expected epidemic period | | | | | | | | | | | |
| Onset week | W06-2020 | W09-2020 | W24-2020 | W47-2020 | W48-2020 | W49-2020 | W48-2020 | W50-2020 | W27-2020 | W21-2020 | W42-2020 |
| Peak week | W10-2020 | W14-2020 | W34-2020 | W50-2020 | W01-2021 | W52-2020 | W01-2021 | W04-2021 | W36-2020 | W32-2020 | W48-2020 |
| Offset week | W22-2020 | W28-2020 | W28-2020 | W05-2021 | W07-2021 | W05-2021 | W10-2021 | W12-2021 | W50-2020 | W42-2020 | W07-2021 |
| Observed epidemic period | | | | | | | | | | | |
| Onset week | W35-2020 | W44-2021 | W33-2021 | W07-2021 | W22-2021 | W25-2021 | W27-2021 | W39-2021 | W21-2021 | W41-2020 | - |
| Peak week | W40-2020 | - | W43-2021 | W11-2021 | W29-2021 | W30-2021 | W35-2021 | - | W28-2021 | W45-2020 | - |
| Offset week | W42-2020 | - | - | W17-2021 | W44-2021 | W35-2021 | W42-2021 | - | W34-2021 | W02-2020 | - |
| Second RSV epidemic period during COVID-19 pandemic | | | | | | | | | | | |
| Onset week | W46-2020 | - | - | W44-2021 | - | - | - | - | - | - | - |
| Peak week | W10-2021 | - | - | - | - | - | - | - | - | - | - |
| Offset week | W11-2021 | - | - | - | - | - | - | - | - | - | - |
| Delay of first RSV epidemic during COVID-19 pandemic | | | | | | | | | | | |
| Delayed / missed season | delayed | missed | missed | delayed | delayed | delayed | delayed | missed | missed | delayed | missed |
| Onset delay (weeks) | 29 | 88 | 62 | 13 | 27 | 29 | 32 | 42 | 47 | 20 | - |
| Peak delay (weeks) | 30 | - | - | 14 | 28 | 31 | 34 | - | 45 | 13 | - |
| Season of RSV epidemic onset | | | | | | | | | | | |
| Pre-pandemic RSV seasons | Summer | Summer | Winter | Winter | Winter | Winter | Winter | Winter | Summer | Summer | Autumn |
| First RSV epidemic during COVID-19 pandemic | Winter | Spring | Winter | Winter | Summer | Summer | Summer | Autumn | Summer | Autumn | - |

Conclusions/Learning Points: The first RSV season during the COVID-19 pandemic was delayed in the eleven countries included. Re-opening of schools was consistently associated with increased RSV activity. As NPI policies were often changed concomitantly, the observed association between RSV activity and school closures may be partly attributed to other NPIs.

PD068 / #1850

TELOMERE LENGTH AND IMMUNOLOGICAL HEALTH IN SOUTH AFRICAN CHILDREN

E-Posters

POSTER DISCUSSION SESSION 02: GLOBAL HEALTH & TB

Ginevra Pistocchi¹, Laura Arencibia¹, Carlota Miranda², Avy Violari³, Diana Gibb⁴, Mark Cotton⁵, Nigel Klein², Helen Payne¹

¹Imperial College London, Paediatric Infectious Diseases, London, United Kingdom, ²University College London, Paediatric Infectious Diseases, London, United Kingdom, ³Chris Baragwanath Hospital, Perinatal Hiv Research Unit, Johannesburg, South Africa, ⁴University College London, Mrc Clinical Trials Unit, London, United Kingdom, ⁵Stellenbosch University, Paediatric Infectious Diseases, Cape Town, South Africa

Backgrounds: Telomere length (TL) reflects immunosenescence and it is recognised that children with perinatally-acquired HIV (paHIV) have shorter telomere length than HIV-uninfected children. An improved understanding of factors that influence TL in children with and without paHIV may give valuable insight into strategies to preserve the immunological health of children.

Methods:: Absolute TL was quantified by PCR from DNA extracted from peripheral blood mononuclear cells collected from 160 healthy HIV-uninfected South African children and 101 participants of the children with HIV early antiretroviral (CHER) trial. 74 and 49 samples were used at 96 and 248 weeks of the CHER trial from all arms combined. Factors that may be associated with TL were evaluated including clinical and immunophenotypes, and measures of thymic and naïve B-cell output.

Results: A dynamic trend in TL was found in HIV-uninfected children corresponding to peaks in thymic output and naïve B-cell output around 2 years. However, no association with TL and activated or proliferating CD4 or CD8 T-cells was found in HIV-uninfected children. Neither was a relationship observed between TL and gender, ethnicity, z-score for weight or past medical history in HIV-uninfected children. Children with paHIV had significantly shorter TL than HIV-uninfected children at 96 weeks ($p < 0.0001$) but not at 248 weeks ($p = 0.074$).

Conclusions/Learning Points: Our findings highlight the potential contribution of thymic and naïve B-cell output to average leukocyte TL in early childhood. The absence of association of TL shortening and immune activation or proliferation rates, as reported elsewhere, may be due to the compensatory response of these primary lymphoid organs. Further research is needed to explore feedback mechanisms that promote thymic and naïve B-cell output.

INFECTION SCREENING IN UNACCOMPANIED ASYLUM-SEEKING CHILDREN - AN EXPERIENCE FROM THREE CENTRES

E-Posters

POSTER DISCUSSION SESSION 02: GLOBAL HEALTH & TB

Sarah Eisen¹, Bhanu Williams², Jonathan Cohen³

¹University College London Hospital NHS Foundation Trust, Paediatrics, London, United Kingdom, ²Northwick Park Hospital, Paediatrics, London, United Kingdom, ³Evelina London Children's Hospital, Department Of Paediatric Infectious Diseases And Immunology, London, United Kingdom

Backgrounds: This work aims to describe rates of common infectious diseases in unaccompanied asylum-seeking children and young people (UASC) seen in three London paediatric infectious disease clinics with established UASC screening services.

Methods:: An audit of routinely collected anonymised patient data was performed, All unaccompanied asylum-seeking children referred to the three clinics between January 2016 and March 2022 were included. Data collection was performed using Excel.

Results: Results 898 individuals from 33 countries were included, 87% were male, median age was 17 years (range 10-19). Individuals from Eritrea, Afghanistan and Sudan constituted the majority of those seen (56%). 97.8% (879/898) were tested for tuberculosis, of whom 168/879 (19.1%) were positive; of these, 44%, 40% and 24% individuals were positive from Ethiopia, Eritrea and Sudan respectively. 36/865 (4.2%) tested positive for Hepatitis B, 1/864 (0.1%) for hepatitis C, and 2/867 (0.2%) for HIV. Positive results were returned in 42/541 (7.8%) tested for giardia and 21/552 (3.8%) tested for tapeworm 119/732 (16.3%) tested positive for schistosomiasis (16.3%). Rates of sexually transmitted infections were low (0.8%, 0.2%, 0.9% for syphilis, gonorrhoea and chlamydia respectively). Overall, 439/898 (30%) individuals were found to have an infection, and 103/898 (11.4%) had multiple infections identified.

Conclusions/Learning Points: Conclusions The majority of patients were appropriately tested for infections with a high rate of identification of treatable asymptomatic infection. Infections were of both individual and public health significance. UASC from East Africa had particularly high rates of both tuberculosis and schistosomiasis, indicating opportunity to consider treatment for schistosomiasis and other infections at the time of migrant TB testing. We suggest approaches to achieve timely and appropriate screening for a range of infections to better adhere to national guidelines.

PD070 / #1931

FAMILY INFECTION SCREENING AND TREATMENT CLINIC – A NOVEL INITIATIVE FOR AFGHAN FAMILIES IN THE UK UNDER THE AFGHAN RELOCATION AND ASSISTANCE POLICY

E-Posters

POSTER DISCUSSION SESSION 02: GLOBAL HEALTH & TB

Paola Cinardo¹, Rebecca Lilygreen², Aileen Ni'Chaoilte¹, Nicky Longley¹, Sarah Eisen²

¹Hospital for Tropical Diseases, UCLH, Infection, London, United Kingdom, ²University College London Hospital NHS Foundation Trust, Paediatrics, London, United Kingdom

Backgrounds: We aimed to describe rates of infectious diseases identified in recently arrived Afghan families, in our Family Infection Clinic in London. The clinic was established in response to the Afghan Relocation and Assistance Policy, following collapse of the Afghan government and air evacuation from Kabul.

Methods:: All Afghan families referred between August 2021 - February 2022 were included. Routinely collected anonymised patient data were analysed using Excel.

Results: 127 individuals (23 families) were screened, of which 47% were male; 89 were children. Median age was 8y (children; range 0-17), and 34y (adults; range 27-52). 6/37 (16.2%) adults and 37/85 (43.5%) children were positive for Giardia. 7/38 (18.4%) adults and 1/89 children (1.1%) were positive for tuberculosis infection. 1/89 (1.1%) children were positive for strongyloides, and 1/85 (1%) for Entamoeba histolytica. Of adults, 1/38 (2.6%) was positive for hepatitis B, and 1 (2.6%) for syphilis. No other sexually transmitted infections were diagnosed. Overall, 16/38 adults (42.1%) and 50/89 (56.1%) children had an infection identified; 3 adults (7.9%) and 3 (3.4%) children had multiple infections. 15 families had more than one infection within the family group. 100% of infections diagnosed were treated in Family Treatment Clinic.

Conclusions/Learning Points: This population had a high rate of asymptomatic infection, of both personal and public health significance. Infection screening of this vulnerable group is important to allow appropriate treatment. Rates of infection are lower than our previously published data regarding unaccompanied asylum-seeking children; likely due to the relatively direct journey and brief period of disruption experienced by this Afghan population compared to many other asylum-seeking populations. The exception is Giardia, where the higher rate found here is likely linked to exposure to dirty water during the wait for evacuation.

COMMON BUT NOT HARMLES: RELATIONSHIP BETWEEN RESPIRATORY INFECTIONS AND ANTIBIOTICS IN THE FIRST YEAR OF LIFE AND ASTHMA IN 6-7 YEARS OLD CHILDREN

E-Posters

POSTER DISCUSSION SESSION 03: RESPIRATORY INFECTIONS

Maria Dominguez¹, Teresa De La Calle-Cabrera², Sonia Arriba-Mendez³, Francisco Javier Pellegrini-Belinchon³, Jose Martin-Ruano¹, Maria Del Carmen Sanchez-Jimenez¹, Maria Concepcion Vega-Hernández⁴

¹Gerencia de Atención Primaria de Salamanca, Centro De Salud San Juan, Salamanca, Spain, ²Centro de Salud de Tamames, Gerencia De Atención Primaria De Salamanca, Salamanca, Spain, ³Universidad de Salamanca, Biomedical And Diagnostic Science, Salamanca, Spain, ⁴University of Salamanca, Estadística Multivariante Aplicada, Salamanca, Spain

Backgrounds: Respiratory infections are very common in the first year of life (FYL), and antibiotics are also given frequently. Early wheeze has been linked to infections due to RSV and other viruses, but for persistent asthma development the relationship is not so clear and thought to be relevant only if genetic predisposition. Antibiotics are sometimes related to asthma, but confounding is suspected.

Methods: A questionnaire was completed by the parents of 2388 6-7 years old children from Salamanca province in Spain, as part of the Global Asthma Network (GAN) study. Main variables analyzed were: wheeze in the 12 months before the questionnaire was completed (Current Wheeze=CW), asthma diagnosed by a doctor (DDA) and severe asthma (SA). A descriptive analysis and uni- and multivariate logistic regression analysis were performed to analyze associations between the variables.

Results: 45% had one or more infections in the FYL, and 14.9% had ever suffered a pneumonia. Antibiotics were given to 38.7% of the children in the FYL. Infections in the FYL, and a pneumonia ever were risk factors for all three asthma parameters, while antibiotics were also found to be risk factors, mainly if used to treat respiratory infections (See Table1). Infections and antibiotics for respiratory infections and pneumonia were found to be risk factors in multivariate analysis even when adjusting for sex, prematurity, history of atopy, breast-feeding, use of paracetamol, and maternal smoking.

Table 1. Logistic regression analysis for risk factors of respiratory infections and antibiotics in the first year of life GAN children (n=2388).

| | CW 9.2% | | | DDA 6.9% | | | SA 3% | | |
|--|-----------|--------------|---------|----------|--------------|---------|----------|---------------|---------|
| | n(%) | OR(95%CI) | p-value | n(%) | OR(95%CI) | p-value | n(%) | OR(95%CI) | p-value |
| Respiratory Infections in first year | 130(59.4) | 2.0(1.5-2.7) | <0.001 | 99(59.6) | 2.0(1.4-2.7) | <0.001 | 46(63.9) | 2.3(1.4-3.7) | 0.001 |
| Number of Infections in first year | | | | | | | | | |
| None | 81(37.0) | | <0.001 | 61(36.7) | | <0.001 | 24(33.3) | | 0.001 |
| 1 | 50(22.8) | 1.5(1.0-2.1) | 0.037 | 37(22.3) | 1.4(0.9-2.2) | 0.094 | 17(23.6) | 1.7(0.9-3.1) | 0.115 |
| 2 to 5 | 63(28.8) | 2.4(1.7-3.5) | <0.001 | 48(28.9) | 2.4(1.6-3.6) | <0.001 | 21(29.2) | 2.6(1.4-4.6) | 0.002 |
| 6 or more | 17(7.8) | 2.9(1.6-5.1) | <0.001 | 14(8.4) | 3.1(1.7-5.7) | <0.001 | 8(11.1) | 4.3(1.9-9.7) | 0.001 |
| Pneumonia ever | 82(37.4) | 4.4(3.2-5.9) | <0.001 | 64(38.6) | 4.5(3.2-6.3) | <0.001 | 33(45.8) | 5.6(3.4-9.0) | <0.001 |
| Antibiotics in first year of life | 106(48.4) | 1.6(1.2-2.2) | 0.001 | 87(52.4) | 2.0(1.4-2.7) | <0.001 | 35(48.6) | 1.5(0.9-2.5) | 0.081 |
| Number of Antibiotics in first year | | | | | | | | | |
| 1 | 43(19.6) | | 0.741 | 25(15.1) | | 0.020 | 13(18.1) | | 0.669 |
| 2 to 5 | 53(24.2) | 1.2(0.8-1.8) | 0.464 | 51(30.7) | 2.0(1.2-3.4) | 0.005 | 19(26.4) | 1.4(0.7-2.8) | 0.379 |
| 6 or more | 6(2.7) | 1.0(0.4-2.4) | 0.959 | 6(3.6) | 1.7(0.7-4.5) | 0.244 | 2(2.8) | 1.1(0.2-4.8) | 0.937 |
| Antibiotic for respiratory infections | 85(38.8) | 2.0(1.3-3.1) | 0.003 | 74(44.6) | 3.4(1.9-6.0) | <0.001 | 34(47.2) | 4.1(1.6-10.5) | 0.004 |

CW: Current Wheeze. DDA: Doctor Diagnosed Asthma. SA: Severe Asthma.

Conclusions/Learning Points: Respiratory infections and antibiotics for them, were found and confirmed

to be risk factors for asthma at age 6-7 in our population, while the number of courses of antibiotics received was not found to be significant. These early common infections have an impact in later respiratory disease.

RETROSPECTIVE DATABASE ANALYSIS ASSESSING THE BURDEN OF BRONCHIOLITIS AND LOWER RESPIRATORY TRACT INFECTIONS IN CHILDREN < 24 MONTHS OF AGE IN ITALY

E-Posters

POSTER DISCUSSION SESSION 03: RESPIRATORY INFECTIONS

Elisa Barbieri¹, Sara Cavagnis¹, Antonio Scamarcia², Lorenzo Bertizzolo³, Salvatore Parisi³, Mathieu Bangert⁴, Luigi Cantarutti², Carlo Giaquinto¹, Anna Cantarutti⁵

¹University of Padua, Division Of Paediatric Infectious Diseases - Department For Woman's And Children's Health, Padua, Italy, ²So.Se.Te, Pedianet, Padua, Italy, ³Sanofi Pasteur, Medical Affairs, Milan, Italy, ⁴Sanofi Pasteur, Medical Affairs, Lyon, France, ⁵Universita' Milano-Bicocca, Department Of Statistics And Quantitative Methods - Unit Of Biostatistics, Epidemiology And Public Health, Milan, Italy

Backgrounds: Bronchiolitis is the most common lower respiratory tract infection (LRTI) in infants, and it is mainly caused by the Respiratory Syncytial Virus (RSV). In Italy, the disease presents seasonally from November to April with peaks of hospitalizations in January and February, but the burden at primary care level is not well understood. Here we describe the epidemiological burden of bronchiolitis and RSV infection in Italy over eight consecutive years.

Methods: This retrospective analysis used data from Pedianet, a paediatric primary care database of 161 family paediatricians. We evaluated the incidence rates (IR) of bronchiolitis, RSV-bronchiolitis and RSV-LRTIs in children <24 months of age, between January 2012 to December 2019. The role of prematurity on bronchiolitis' onset was also evaluated and expressed as odds ratio.

Results: In the 108960 children included 7956 episodes of bronchiolitis and 37827 episodes of LRTIs were recorded, for an IR of 47 and 221 x 1000 person-years respectively. IRs were higher in males and infants <6months (Figure 1), and the IR peaked in January and February. IRs did not vary significantly throughout the 8 years considered. In total 388 RSV-bronchiolitis and 394 RSV-LRTIs were confirmed. RSV infections peaked in infants <6months (IR=9x1000 person-years), however, an age bias in testing is acknowledged. In 97% of bronchiolitis cases, children had no comorbidities. Severe-to-extreme prematurity (gestational age <32 weeks) doubled the risk of bronchiolitis (OR=1.9 [95%CI: 1.52-

Figure 1. Incidence rate of bronchiolitis (orange) and LRTI (green) stratified by RSV aetiology (RSV-bronchiolitis (dark orange) and RSV-LRTI (dark green)) in children aged 0-2 years overall and stratified by age class. The whiskers represent 95% confidence intervals. *Pedinet* 2012-2019

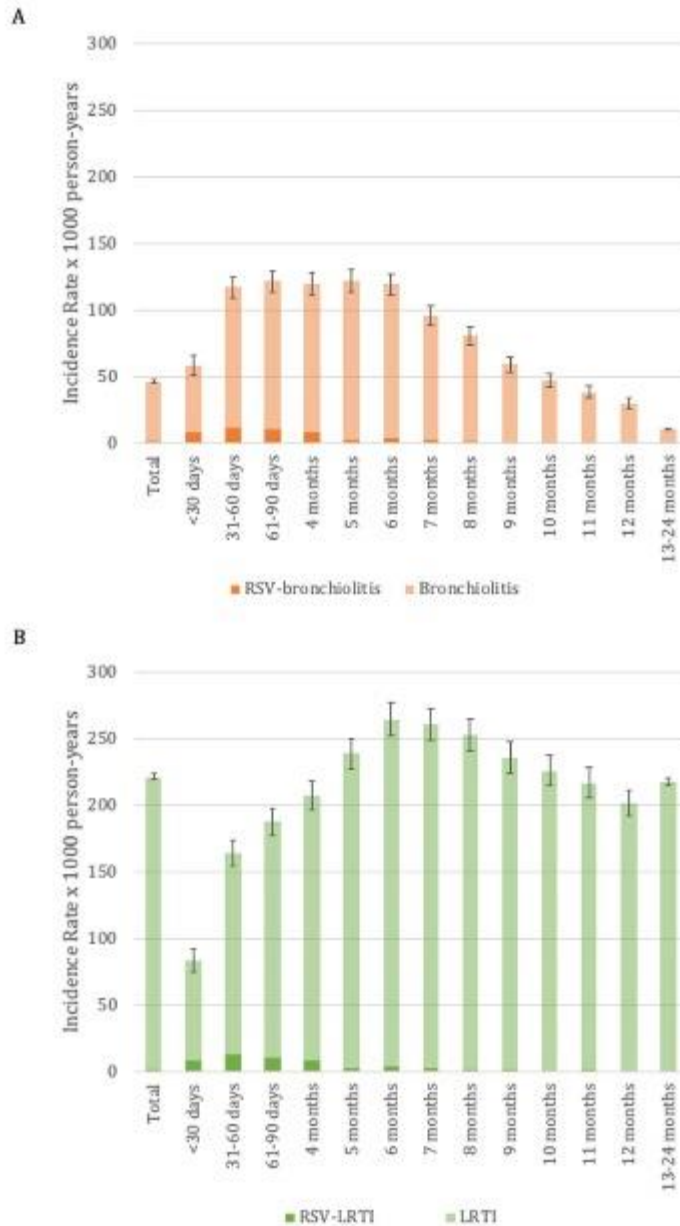

2.37]).

Conclusions/Learning Points: Our results confirm that the burden of bronchiolitis and RSV presents a seasonality similar to the cause-specific hospitalization trends in Italy. Although prematurity increased the risk of bronchiolitis, 97% of cases had no comorbidities, showing that all children are at risk. Further studies focused on RSV at the outpatient level are needed.

PD073 / #785

CORRELATION OF RSV SUBTYPE AND VIRAL LOAD WITH DISEASE SEVERITY OF ACUTE RESPIRATORY TRACT INFECTION: A PROSPECTIVE COHORT STUDY IN SOUTHWEST GERMANY.

E-Posters

POSTER DISCUSSION SESSION 03: RESPIRATORY INFECTIONS

Julia Gsenger¹, Britta Manuel², Clara Ihling^{1,3,4}, Jürgen Grulich-Henn², Paul Schnitzler¹, Julia Tabatabaj^{1,2,4}

¹Center for Infectious Diseases, Virology, Heidelberg, Germany, ²Center for Childhood and Adolescent Medicine, General Pediatrics, Heidelberg, Germany, ³Dr. von Haunersches Kinderspital, Pediatrics, München, Germany, ⁴German Centre for Infection Research (DZIF), Virology, Heidelberg, Germany

Backgrounds: Respiratory syncytial virus (RSV) is the leading cause of hospitalisation especially in infants and young children with acute respiratory tract infection (RTI). The role of viral factors on the clinical course of RSV infection remains unclear. This study aims to investigate the impact of RSV subtype and viral load (VL) on the course and disease severity of RSV infection in children.

Methods: Clinical data and nasopharyngeal swabs were prospectively collected of children <3 years presenting with RTI to the outpatient unit of Heidelberg Childrens' Hospital during winter seasons 2017/18, 2018/19, and 2019/20. A total of 1.171 patients were screened for RSV. RSV subtype and VL were determined by performing a quantitative RT-PCR. Clinical data were obtained using a standardised questionnaire including demographics, admission diagnoses, respiratory symptoms, laboratory parameters, and clinical course of disease.

Results: 351 children with a median age of 3.5 months (IQR 1.5-11.0) infected with RSV were included. The predominant subtype was RSV-B in 2017/18 (56.4%) and 2018/19 (84.0%) and shifted to RSV-A (80.0%) in 2019/20. There were no significant differences in demographics and clinical course of infection when comparing patients infected with RSV-A versus RSV-B. RS VL ranged from 1.5×10^0 to 6.0×10^{11} genome/copies per millilitre (IQR 5.6×10^7 - 1.3×10^9) and showed a significant decline with higher age at time of infection ($\rho = -0.16$, $p < 0.01$), longer duration of symptoms prior to admission ($\rho = -0.16$, $p < 0.01$) and higher blood leucocyte count ($\rho = -0.17$, $p < 0.01$). However, VL did not correlate with markers of disease severity such as duration of hospitalisation, signs of respiratory failure, or lower RTI.

Conclusions/Learning Points: Although RSV infection is an important cause of severe RTI in infants and young children, this study could not confirm an association between RSV subtype or VL and disease severity.

EPIDEMIOLOGICAL CHARACTERISTICS AND MODELLING FOR SHORT-TERM PREDICTION OF THE RESPIRATORY SYNCYTIAL VIRUS (RSV) SPREADING IN CATALONIA (SPAIN)

E-Posters

POSTER DISCUSSION SESSION 03: RESPIRATORY INFECTIONS

Aida Perramon¹, Martí Català², M^a Inmaculada Villanueva³, Maria Piñana⁴, Jorgina Vila⁵, Cristina Andrés⁴, Daniel López¹, Antoni Soriano-Arandes⁶, Andrés Antón⁴, Clara Prats¹

¹Universitat Politècnica de Catalunya, Department Of Physics, Barcelona, Spain, ²Fundació Institut d'Investigació en Ciències de la Salut Germans Trias i Pujol (IGTP), Comparative Medicine And Bioimage Centre Of Catalonia (cmcib), Badalona, Spain, ³Institut d'Investigacions Biomèdiques August Pi i Sunyer, Idibaps, Barcelona, Spain, ⁴Vall d'Hebron Hospital Universitari, Vall d'Hebron Institut de Recerca (VHIR), Universitat Autònoma de Barcelona, Respiratory Virus Unit, Virology Section, Microbiology Department, Barcelona, Spain, ⁵Vall d'Hebron Hospital Universitari, Universitat Autònoma de Barcelona, Paediatric Hospitalisation Unit, Department Of Paediatrics, Barcelona, Spain, ⁶Hospital Universitari Vall d'Hebron (HUVH), Pediatric Infectious Diseases And Immunodeficiencies Unit., Barcelona, Spain

Backgrounds: Respiratory Syncytial Virus (RSV) has been the most prevalent cause of viral respiratory infection in children until the outbreak of the SARS-CoV-2 pandemic. In Catalonia (Spain), the RSV epidemic season occurs every year between October and April. However, RSV cases were sporadic in the 2020-2021 season, and the epidemic peak shifted to summer 2021. Our aim is to characterize the RSV epidemic in Catalonia using a model-based approach analysing the changes in the observed patterns caused by the SARS-CoV-2 pandemic. Additionally, we tested the model for short- and mid-term predictive purposes.

Methods: Epidemiological data of attended children with RSV infection were collected from Vall d'Hebron Hospital Universitari (September 2013-December 2021). An RSV surveillance season was defined as a year starting in September. A Gompertz function was adjusted to each surveillance season and the parameters describing it were compared. Successive fittings were carried out to 2021-2022 season with incremental data in order to test the predictive capacity of the model.

Results: Figure 1 shows the seasonal adjustment of the model, with an average R^2 of 0.99 (2021-2022 season is yet to be optimized). The fitted parameters did not show a clear pattern inter-seasonally. However, season 2020-2021 had a significantly steeper exponential growth and a higher total number of laboratory-confirmed infections, while the epidemic final slowing rate was similar to previous seasons. This may be due to a higher susceptible population to the infection and/or meteorological factors.

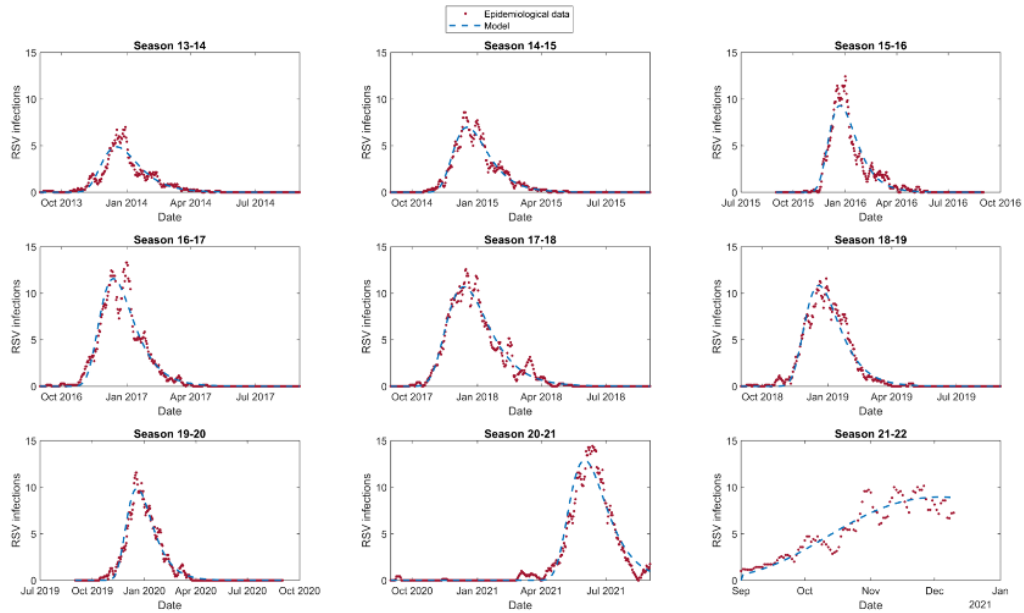

Figure 1. Pointed in red, the 7-days moving average of the epidemiological data gathered in the Vall d'Hebron Hospital Universitari. Dashed in blue, the model adjustment of RSV infections.

Conclusions/Learning Points: An empirical Gompertz model for RSV monitoring allowed for the characterisation of the epidemic waves, showing the differences between current and pre-pandemic RSV waves and a reliable prediction capacity.

CLINICAL STABILISATION AFTER HOSPITAL ADMISSION IN CHILDREN WITH COMMUNITY-ACQUIRED PNEUMONIA IN SWITZERLAND

E-Posters

POSTER DISCUSSION SESSION 03: RESPIRATORY INFECTIONS

Malte Kohns Vasconcelos^{1,2}, Michael Coslovsky³, Regina Santoro⁴, Patrick M. Meyer Sauter⁵, Kristina Keitel^{6,7}, Ulrich Heininger¹, John Van Den Anker², Julia Bielicki^{1,2}

¹University of Basel Children's Hospital (UKBB), Infectious Diseases And Vaccinology, Basel, Switzerland, ²University of Basel Children's Hospital, Department For Paediatric Pharmacology, Basel, Switzerland, ³University of Basel, Clinical Trial Unit, Basel, Switzerland, ⁴University of Basel Children's Hospital, Paediatric Research Centre, Basel, Switzerland, ⁵University Children's Hospital Zurich, Division Of Infectious Diseases And Hospital Epidemiology, Zurich, Switzerland, ⁶Inselspital, University of Bern, Paediatric Emergency Department, University Children's Hospital, Bern, Switzerland, ⁷University of Basel, Swiss Tropical And Public Health Institute, Basel, Switzerland

Backgrounds: In previous studies from other high-resource settings, the average length of stay (LOS) of hospitalised children with CAP is 2 days. Current Swiss data for readmission rates after admission for community-acquired pneumonia are lacking.

Methods: At emergency departments at eight paediatric hospitals in Switzerland, the KIDS-STEP Trial enrolls children below 14 years of age with CAP based on clinical criteria. The trial is a superiority trial for the effect of oral corticosteroids on clinical stabilisation within 48 hours and risk of CAP-related re-admission within 28 days. Clinical stabilisation was defined as normalisation of deranged vital signs on two subsequent measurements or discharge from hospital. In a blinded interim analysis after enrolment of 29% of the expected sample size, we re-assessed the probabilities of the trial's main outcomes using a Bayesian approach based on Beta distributions. We weighted pre-trial assumptions as corresponding to 50 patient observations. Time until clinical stability was estimated using parametric survival models with an exponential distribution.

Results: Until December 2021, 214 participants had completed follow-up. 202 (94.3%) had complete data on time to the primary outcomes. Pre-trial assumptions, observed participant data and posterior distributions are shown in table 1. The geometric mean of the observed time clinical stabilisation was 31.56 hours (95%-confidence interval: 26.486, 37.597). The pooled expected baseline clinical stability time was estimated at 54.35 hours (95%-CI: 47.35, 62.39)

| | N (events) | Risk | |
|---|------------|-----------------------|--|
| <i>Prior assumption</i> | | | |
| | | <i>point estimate</i> | <i>95% central interval</i> |
| Clinical stabilisation at 48 hours | - | 0.750 | 0.622, 0.859 |
| CAP-related re-admission within 28 days | - | 0.050 | 0.009, 0.125 |
| <i>Observed data</i> | | | |
| | | <i>point estimate</i> | <i>95% Clopper-Pearson confidence interval</i> |
| Clinical stabilisation at 48 hours | 120 | 0.594 | 0.523, 0.662 |
| CAP-related re-admission within 28 days | 16 | 0.079 | 0.046, 0.125 |
| <i>Posterior probabilities</i> | | | |
| | | <i>point estimate</i> | <i>95% credible interval</i> |
| Clinical stabilisation at 48 hours | - | 0.625 | 0.564, 0.684 |
| CAP-related re-admission within 28 days | - | 0.073 | 0.045, 0.109 |

Conclusions/Learning Points: On average, children hospitalised in Switzerland with CAP show normalisation of deranged vital signs measurements or are judged fit for hospital discharge on the third inpatient day. Re-admission occurs in 7%. Combined with the high incidence of CAP, these findings

underline the high burden of disease for families and health systems and the need for effective supportive treatments.

SURVEILLANCE OF PEDIATRIC RSV ADMISSIONS IN DUTCH HOSPITALS: THE SPREAD STUDY

E-Posters

POSTER DISCUSSION SESSION 03: RESPIRATORY INFECTIONS

Yvette Löwensteyn¹, Neele Rave¹, Eline Bel¹, Katja Steenhuis¹, Anne Teirlinck², Johannes Van Goudoever³, Britt Van Keulen³, Dan Weinberger⁴, Gertjan Driessen⁵, Károly Illy⁶, Vincent Jaddoe⁷, Liesbeth Duijts⁷, Louis Bont¹

¹University Medical Centre Utrecht, Pediatric Infectious Diseases, Utrecht, Netherlands, ²National Institute for Public Health and the Environment, Virology, Bilthoven, Netherlands, ³Amsterdam UMC, University of Amsterdam, Vrije Universiteit, Emma Children's Hospital, Pediatrics, Amsterdam, Netherlands, ⁴Yale School of Public Health, Epidemiology Of Microbial Diseases, New Haven, United States of America, ⁵Maastricht University Medical Center, Pediatrics, Maastricht, Netherlands, ⁶Ziekenhuis Rivierenland, Pediatrics, Tiel, Netherlands, ⁷Erasmus MC, Sophia Children's Hospital, Pediatrics, Rotterdam, Netherlands

Backgrounds: Respiratory syncytial virus (RSV) was virtually absent in the Dutch winter of 2020/2021, likely due to the implementation of COVID-19-related public health measures. In May 2021, RSV circulation started in the west of the Netherlands. We aimed to investigate the spread of RSV over time in the Netherlands in 2021 and to compare demographic and clinical characteristics between children admitted during the 2021 epidemic and those admitted during the 2018/2019 and 2019/2020 winter epidemics.

Methods: In this ongoing nationwide real-time observational study, pediatricians of 45 participating hospitals were requested to share their weekly number of RSV bronchiolitis-related admissions in children younger than two years between May 2021-March 2022. We collected retrospective patient data in 10/45 hospitals and compared characteristics using chi-square and Mann-Whitney-U tests.

Results: Starting from May 24, 2021, an RSV epidemic was observed. During the peak week (July 12-18), 210 patients were admitted with RSV bronchiolitis. Unlike previous years following an epidemic, RSV-related admissions did not disappear but stabilized to 50 patients weekly during fall and early-winter. Preliminary analyses (n=174) show that patients admitted in 2021 were older than those in previous winters (median age 126 days vs. 62 days, p=0.02) and less often admitted to ICU (27% vs. 56%, p<0.001). Presence of comorbidities was similar (16% vs. 14%).

Conclusions/Learning Points: The SPREAD study is the first real-time national surveillance of pediatric RSV-related hospitalizations in the Netherlands and provides the opportunity to understand the spread of RSV over time and space. Spatiotemporal modeling studies are instrumental to manage future RSV epidemics during the ongoing COVID-19 pandemic. Further analyses are required to understand the potential shift in age distribution of children hospitalized for RSV bronchiolitis during the delayed RSV epidemic.

HOSPITAL BURDEN OF ACUTE LOWER RESPIRATORY INFECTION DUE TO RESPIRATORY SYNCYTIAL VIRUS IN SPANISH CHILDREN, 2015–2018

E-Posters

POSTER DISCUSSION SESSION 03: RESPIRATORY INFECTIONS

Federico Martín-Torres^{1,2}, Mafalda Carmo³, Leticia Platero⁴, Georgina Drago Manchón⁵, Juan Luis López-Belmonte⁶, Cristina Ibáñez⁷, Mathieu Bangert⁸, Javier Díez-Domingo⁹

¹Hospital Clínico Universitario de Santiago de Compostela, Translational Paediatrics And Infectious Diseases, Paediatrics Department, Santiago de Compostela, Spain, ²University of Santiago de Compostela, Genetics, Vaccines And Paediatrics Research Group, Santiago de Compostela, Spain, ³IQVIA, Real World Insights, Barcelona, Spain, ⁴Sanofi Pasteur, Medical Department, Madrid, Spain, ⁵Sanofi Pasteur, Market Access - Heor & Pricing, Barcelona, Spain, ⁶Sanofi Pasteur, Value & Access, Barcelona, Spain, ⁷Sanofi Pasteur, Medical Department, Barcelona, Spain, ⁸Sanofi Pasteur, Medical Affairs, Lyon, France, ⁹University of Valencia, Vaccine Research Department, Valencia, Spain

Backgrounds: Respiratory syncytial virus (RSV) infection is a common cause of hospitalization due to acute lower respiratory infection (ALRI) in young children specially related to bronchiolitis and pneumonia. This study aimed to analyse the burden of hospitalizations potentially related to RSV in children in Spain using different ALRI ICD-9/10 codes searching for more robust estimates.

Methods: In this retrospective study, hospitalizations potentially related to RSV in children aged <5 years old were reviewed for three seasons (2015/16-2017/2018; September to June), using anonymized administrative data from public hospital discharges in Spain. Three case definitions were considered: (a) RSV-specific; (b) RSV-specific and unspecified acute bronchiolitis (RSV-specific&Bronchiolitis), and; (c) RSV-specific and unspecified ALRI (RSV-specific&ALRI).

Results: We found a mean of 17.0 yearly RSV-specific&ALRI hospitalizations per 1,000 children aged <5 years, accounting for 25.9% of all hospitalizations in children under 5 years and resulting in a mean annual cost of €87.1 million. RSV-specific codes accounted for 66.1% of RSV-specific&Bronchiolitis cases and for 39.2% of RSV-specific&ALRI cases. Mechanical ventilation was used in 4.5%-6.0% of cases. Children aged <2 years old accounted for 80.4% of cases (those <1 year old explained 61.7%). Healthy children accounted for 83.3% of costs during the period, as they generated most of hospitalizations (92.9%). However, mean hospitalization cost per RSV patient was higher in children with a risk factor, who also presented longer hospital stays (Table 1).

Table 1. Summary of results for potential RSV related hospitalizations, per RSV case definition and age (season 2015/16 to 2017/18^(a))

| Variable | Patients' characteristics | Aged 0-59 months (<5 years old) | | | Aged 0-23 months (<2 years old) | | | Aged 24-59 months | | |
|---|---------------------------------|---------------------------------|---|------------------------------------|---------------------------------|---|------------------------------------|-----------------------------|---|------------------------------------|
| | | RSV-specific ^(b) | RSV-specific & Bronchiolitis ^(c) | RSV-specific & ALRI ^(d) | RSV-specific ^(b) | RSV-specific & Bronchiolitis ^(c) | RSV-specific & ALRI ^(d) | RSV-specific ^(b) | RSV-specific & Bronchiolitis ^(c) | RSV-specific & ALRI ^(d) |
| Number of cases (# hospitalizations) | Total | 43,247 | 65,443 | 110,229 | 40,915 | 62,918 | 88,603 | 2,332 | 2,525 | 21,626 |
| Cases per 1,000 people | Total | 6.7 | 10.1 | 17.0 | 16.4 | 25.2 | 35.5 | 0.6 | 0.6 | 5.4 |
| Percentage of cases requiring invasive MV (%) | Total | 1.1 | 1.0 | 0.9 | 1.1 | 1.0 | 1.0 | 1.2 | 1.1 | 0.6 |
| Percentage of cases requiring non-invasive MV (%) | Total | 4.9 | 4.5 | 3.6 | 5.1 | 4.6 | 4.1 | 2.3 | 2.5 | 1.7 |
| Percentage of cases according to childrens' underlying medical conditions (%) | No risk factor | 94.6 | 94.3 | 92.9 | 94.9 | 94.5 | 93.4 | 88.5 | 89.0 | 91.2 |
| | With risk factor ^(e) | 5.4 | 5.7 | 7.1 | 5.1 | 5.5 | 6.6 | 11.5 | 11.0 | 8.8 |
| Mean length-of-stay per episode (days) | Total | 5.7 | 5.4 | 5.1 | 5.7 | 5.4 | 5.1 | 5.0 | 4.9 | 4.1 |
| | No risk factor | 5.3 | 5.0 | 4.6 | 5.4 | 5.0 | 4.8 | 4.4 | 4.3 | 3.7 |
| Mean hospitalization cost per RSV patient (€) | With risk factor ^(e) | 12.3 | 11.2 | 11.4 | 12.7 | 11.3 | 12.7 | 9.5 | 9.3 | 7.5 |
| | Total | 2,447 | 2,303 | 2,406 | 2,437 | 2,239 | 2,417 | 2,612 | 2,551 | 2,360 |
| | No risk factor | 2,262 | 2,136 | 2,163 | 2,260 | 2,131 | 2,152 | 2,310 | 2,263 | 2,205 |
| | With risk factor ^(e) | 5,696 | 5,049 | 5,614 | 5,789 | 5,064 | 6,137 | 4,929 | 4,852 | 3,988 |

ALRI - Acute lower respiratory infection; MV - Mechanical Ventilation; RSV - Respiratory syncytial virus.

(a) Epidemic season includes cases from September to June.

(b) Includes only RSV-specific diagnosis (ICD10 codes: J21.0, J12.1, J20.5 and B97.4; ICD9 codes: 079.6; 466.11; 480.1).

(c) Includes RSV-specific and acute bronchiolitis without specific virus identification diagnosis (previous ICD10 codes, plus J21.8, J21.9; or previous ICD9 codes, plus 466.19).

(d) Includes RSV-specific and other ALRI without specific virus identification diagnosis (previous ICD10 codes, plus J12.8, J12.9, J18.0, J18.8, J18.9, J21.8, J21.9, J20.8, J20.9, J22; or previous ICD9 codes, plus 466.0; 519.8; 480.3; 480.8; 480.9; 487.0; 485; 486).

(e) The following risk factors were considered: heart disease, neuromuscular disorders, bronchopulmonary dysplasia, Down syndrome, immunodeficiency, congenital anomalies of respiratory system, congenital musculoskeletal anomalies, and cystic fibrosis. Prematurity, low birth weight and exposure to tobacco were separately assessed as they do not correspond to underlying medical condition.

Conclusions/Learning Points: At least one out of each 10 hospitalizations in children <5 years is due to RSV. The vast majority of cases occur in otherwise healthy children, suggesting that all infants are at risk of acquiring an RSV infection with severe complications. Further studies are needed, including other healthcare settings, indirect burden, and long-term impact of RSV complications.

PEDIATRIC INFLUENZA AND RESPIRATORY SYNCYTIAL VIRUS INFECTION IN THREE NON-PANDEMIC SEASONS (2017 TO 2020)

E-Posters

POSTER DISCUSSION SESSION 03: RESPIRATORY INFECTIONS

Anca Cristina Draganescu¹, Oana Sandulescu^{2,3}, Anca Streinu-Cerce^{2,3}, Victor Daniel Miron³, Anuta Bilasco¹, Ovidiu Vlaicu⁴, Dragos Florea^{2,3}, Dan Otelea⁴, Daniela Pitigoi^{5,6}, Adrian Streinu-Cerce^{2,3}

¹National Institute for Infectious Diseases "Prof. Dr. Matei Bals", Bucharest, Romania, Pediatrics, Bucharest, Romania, ²National Institute for Infectious Diseases "Prof. Dr. Matei Bals", Bucharest, Romania, Infectious Diseases, Bucharest, Romania, ³Carol Davila University of Medicine and Pharmacy, Infectious Diseases, Bucharest, Romania, ⁴National Institute for Infectious Diseases "Prof. Dr. Matei Bals", Bucharest, Romania, Medical Laboratory, Bucharest, Romania, ⁵Carol Davila University of Medicine and Pharmacy, Epidemiology, Bucharest, Romania, ⁶National Institute for Infectious Diseases "Prof. Dr. Matei Bals", Bucharest, Romania, Epidemiology, Bucharest, Romania

Backgrounds: The COVID-19 pandemic influenced the circulation of other respiratory viruses, so influenza had a low circulation in the 2020/21 season, while respiratory syncytial virus (RSV) showed a peak during the 2021 warm season. The aim of our study is to present the impact of influenza and RSV infection among hospitalized children over three pre-pandemic seasons, 2017-2020.

Methods: We conducted an analysis of data from prospective influenza surveillance among patients hospitalized for ILI in a tertiary infectious disease hospital in Bucharest, Romania. We included in the analysis all children who received RT-PCR testing for influenza and RSV.

Results: A total of 1399 children were hospitalised for ILI over the 3 seasons. The overall positivity rate was 51.1% for influenza and 11.4% for RSV, varying between seasons (66.7%, 41.2%, 57.5% for influenza, 3.7%, 12.9%, 11.4% for RSV). Influenza-positive patients [3 years(IQR:1.7)] were significantly older than those negative [2 years(IQR:1.5), (p<0.001)], while RSV-positive patients were significantly younger [1 years(IQR:0.3), (p<0.001)]. Children with RSV more frequently required oxygen supplementation (26.0% vs. 6.5%, p<0.001) and intensive care (10.0% vs. 3.5%, p<0.001) compared to those with influenza. The duration of hospitalization was significantly longer for RSV [6days(IQR:4.7), (p<0.001)] compared to influenza or negative RT-PCR. The presence of a chronic condition prolonged hospitalization by one day regardless of the viral etiology. There were 15 cases of RSV-influenza co-infection, without impact on clinical course compared to mono-infection.

Conclusions/Learning Points: We identified an increased incidence of influenza and RSV positivity in pre-pandemic years among children admitted for ILI/SARI, which resulted in an increased rate of children requiring oxygen supplementation and/or intensive care hospitalization. Close monitoring of these respiratory viruses with SARS-CoV-2 circulation is necessary to reduce the burden of respiratory infections in the pediatric population.

PD079 / #403

TORQUETENOVIRUS (TTV) IN NASOPHARYNGEAL ASPIRATE OF CHILDREN WITH RESPIRATORY INFECTIONS

E-Posters

POSTER DISCUSSION SESSION 03: RESPIRATORY INFECTIONS

Blanca Bravo¹, Teresa Del Rosal¹, María Bergia¹, M^a Luz García García², Sonia Alcolea¹, Lidia Pertíñez¹, Jorge Atucha¹, Patricia Silvera², Virginia Buitrago², María Iglesias-Caballero³, Noelia Reyes³, Diana Santos³, José Rodrigo-Muñoz⁴, Raquel García-Latorre⁴, Francisco Pozo³, Inmaculada Casas³, Victoria Del Pozo⁴, Cristina Calvo¹

¹Hospital La Paz, Pediatric Infectious Diseases, Madrid, Spain, ²Hospital Severo Ochoa, Pediatrics, Leganés, Spain, ³Centro Nacional de Microbiología, Influenza And Other Viruses Laboratory, Madrid, Spain, ⁴Fundación Jimenez Díaz, Immunology, Madrid, Spain

Backgrounds: Torquetenovirus(TTV) is an ubiquitous anellovirus, responsible for persistent infections and considered an endogenous marker of immune function. The role of TTV as a facilitator of respiratory infections(RI) is unknown. Our aim was to estimate the prevalence of TTV in nasopharyngeal aspirates(NPA) of hospitalized children with RI and correlate them with clinical evolution and immune response.

Methods: Prospective multicenter study performed in two hospitals in Spain. Children admitted with RI were recruited and NPA was taken for RT-PCR for 16 respiratory viruses. TTV PCR and immunological study were analyzed directly in the NPA.

Results:

A)

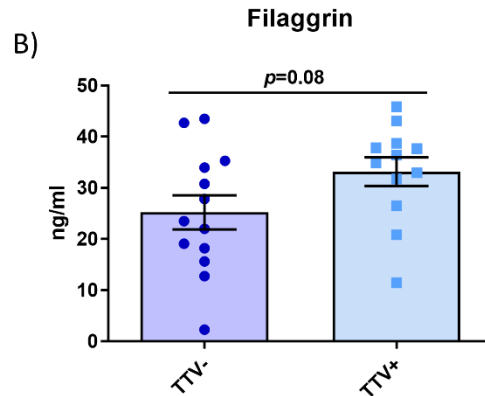
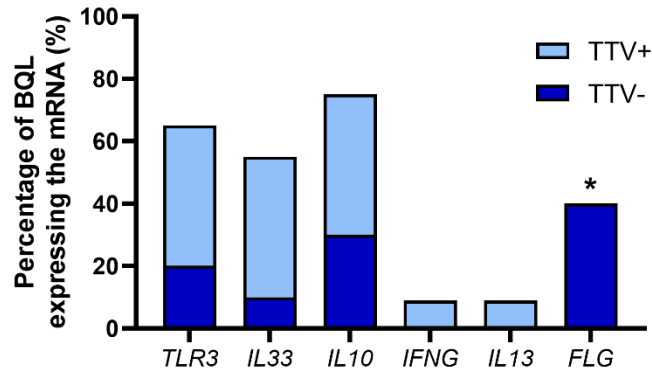

Sixty hospitalized children with a RI and 3 healthy control infants were included. A total of 51/60 cases (85%) had a positive common respiratory viral (CRV) identification; mainly rhinovirus and respiratory syncytial virus in the same proportion (27/63; 42.9%). The most frequent diagnosis were 29/60 (48.3%) bronchiolitis, and recurrent wheezing episodes 22/60 (36.6%); 7/60(11.6%) required PICU admission. A total of 24/63 (38.1%) children had positive TTV in NPA, 23 cases and 1 healthy control. TTV-positive patients had other CRV in 95.8% of cases (23/24) vs 74.4% (29/39) in TTV-negative ones; $p=0.029$. TTV-positive patients tended to be older, having fever and needing PICU admission more often than negative ones. Abnormal chest X-ray was observed more often in TTV-positive patients OR= 2.6 (95% CI 1.3-5.2), $p=0.030$. The genetic expression of filaggrin (involved in the epithelial barrier integrity) was lower in TTV positive patients but the levels of filaggrin in the NPA were increased (Figure 1).

Conclusions/Learning Points: TTV infection is common in children with respiratory infections and could be associated with pneumonia and greater severity, as well as an alteration in filaggrin genetic expression and protein release.

PD080 / #1433

ALTERATION OF PATHOGENS IN CHILDREN WITH CYSTIC FIBROSIS FOLLOWING ANTIBIOTIC THERAPY SELECTED WITH ATBFINDER

E-Posters

POSTER DISCUSSION SESSION 03: RESPIRATORY INFECTIONS

George Tetz¹, Maria Vecherkovskaya², Kristina Kardava², Tatyana Gembitskaya³, Victor Tetz²

¹TGV-DX, Microbiology, New York, United States of America, ²Pavlov First Saint Petersburg State Medical University, Microbiology And Virology, Saint Petersburg, Russian Federation, ³Pavlov First Saint Petersburg State Medical University, Pulmonology Research Institute, Saint Petersburg, Russian Federation

Backgrounds: Cystic fibrosis (CF) leads to extreme dysbiosis in airways of patients from a very early age. These profound changes result in chronic lung infections caused by conventional CF pathogens as well as lesser-known ones. As the time progresses multidrug-resistant (MDR) bacteria emerge. Complex interactions between lung microbiota and pathogenic bacteria represent poorly understood dynamics that influence long term survival of CF patients. AtbFinder is a culture-based test-system that utilizes a proprietary algorithm of “whole microbial community response” to the antibiotics that modulates complexed inter-bacterial interactions at the site of infection. AtbFinder is a 48-well plate containing a novel “TGV” culture medium enabling rapid simultaneous growth of different bacteria in the form of a mixed biofilm.

Methods: 10 CF patients aged 12 to 15 years, receiving prophylactic antibiotic therapy with antibiotics selected based on AtbFinder results were monitored over 3 years. Sputum was obtained during yearly check-up hospitalisations and the shift in primary pathogens was assessed with AtbFinder and retrospectively compared with microbiology data collected when antibiotics were prescribed with conventional methods

Results: At the end of observation period, we found eradication of *P.aeruginosa* in 40% (2 out of 5) of cases, *S. maltophilia* in 67% (2 out of 3) patients. What's more, the mean sputum density of *P.aeruginosa*, *S.aureus*, *A. xylosoxidans*, *S. maltophilia* following antibiotic therapy selected with AtbFinder were decreased by 2.7, 3.4, 2.5 and 3.0 log₁₀ CFU/g (all p<0.05).

Conclusions/Learning Points: Antibiotic optimization with therapy prescribed using AtbFinder results in revealing and progressive eradication of different MDR bacteria from airways of children with CF.

PD081 / #1916

POST-PROCEDURE TRACHEOBRONCHITIS

E-Posters

POSTER DISCUSSION SESSION 03: RESPIRATORY INFECTIONS

Guiem Vaquer^{1,2}, Yolanda Peña-López¹, Montserrat Pujol-Jover^{1,2}, Joan Miquel Pujol-Morro¹, David Roca¹, Laura Seidler¹, Carla Daina¹, Joan Balcells¹

¹Vall d'Hebron Barcelona Hospital Campus, Pediatric Critical Care Department, Barcelona, Spain, ²Vall d'Hebron Barcelona Hospital Campus, Neonatal And Paediatric Transport Unit, Barcelona, Spain

Backgrounds: Though ventilator-associated tracheobronchitis (VAT) is widely accepted as a distinct clinical entity in children and adults, its intermediary role in development of ventilator-associated pneumonia (VAP) and whether early treatment of VAT reduces risk of subsequent VAP remains uncertain. Tracheobronchitis also can occur during the first 48 hours of mechanical ventilation or after airway manipulation (post-procedure tracheobronchitis, PPT). Our aim was to characterize the proportion of VAT and VAP preceded by PPT and VAT, respectively.

Methods:: Cohort study using retrospective review of medical records and prospectively collected quality improvement database from January 2017 to March 2020 in a 16-bed-PICUs in Spain. PPT/VAT/VAP were assessed using the 2008-CDC definition. Children diagnosed from VAT or VAP were included. All VAT/VAP were treated with antibiotics.

Results: A total of 6,707 ventilator-days and 63 ventilator-associated respiratory infections (VARI) were analyzed. Rates of VAT, VAP and VARI for this population were 7.3, 2 and 9.3 per 1,000 ventilator-days, respectively. Among 63 VARI, there were 49 VAT (77.8%) and 14 VAP (22.2%). Seventeen VARIs corresponded to early-onset VARI (27%) and 46 to late-onset VARI (73%). Five out of 14 VAP (35.7%) and 6 out of 49 VAT (12.2%) were preceded by PPT ($p=0.053$). No VAT progressed to VAP. PPT was more frequently associated with early-onset VARI than late-onset VARI (7 out of 17 (41.2%) vs 4 out of 46 (8.7%), $p=0.003$).

Conclusions/Learning Points: Early treatment of PPT may reduce the incidence of early-onset VARI.

IMPACT OF COVID-19 PANDEMIC ON ROUTINE CHILDHOOD VACCINATIONS IN SOUTH WEST LONDON

E-Posters

POSTER DISCUSSION SESSION 04: COVID EFFECTS

Eleanor Buck¹, Jessica Burt², Yingfen Hsia^{3,4}, Konstantinos Karampatsas⁴, Kirsty Le Doare^{4,5,6}

¹St George's, University of London, St George's Hospital Medical School, LONDON, United Kingdom, ²University of Leeds, Leeds School Of Medicine, Leeds, United Kingdom, ³Queen's University Belfast, School Of Pharmacy, Belfast, United Kingdom, ⁴St George's, University of London, Centre For Neonatal And Paediatric Infection, Institute Of Infection And Immunity, LONDON, United Kingdom, ⁵LHSTM Uganda Research Unit, Mrc/uvri, Entebbe, Uganda, ⁶UK Health Security Agency, Pathogen Immunity Group, Porton Down, United Kingdom

Backgrounds: In the UK, the COVID-19 pandemic necessitated measures such as a nationwide lockdown implemented in March 2020. However, these measures led to unintended disruption of routine immunisation services. We carried out a primary care-based cohort study in five general practice (GP) surgeries in South West London to explore this issue with additional socioeconomic and geographical context.

Methods: We compared the completion rates of primary and booster immunisations between a pre-COVID cohort (826 children born between 1/3/2018 and 28/02/2019) and a COVID cohort (775 children born between 1/3/2019 and 28/02/2020). In addition, we performed multivariable logistic regression to explore associations of completion of vaccination with sex, ethnicity, index of deprivation and GP surgery.

Results: Our results have shown a decrease in the uptake of MMR (89.1% vs 83.9%, $p = 0.003$), Hib/Men C (89.0% vs 83.4%, $p = 0.001$), and the booster doses of the PCV13 (88.0% vs 81.2%, $p < 0.001$) and Men B vaccines (87.3% vs 82.9%, $p = 0.006$). After adjustment for sex, index of deprivation and GP surgery, Black/Black British ethnicity was associated with reduced odds of 12-month vaccine uptake compared to infants of White ethnicity (aOR 0.3 (95CI: 0.2- 0.7), $p = 0.005$; 0.4 (0.2- 0.8), $p = 0.008$; 0.4 (0.2- 0.8), $p = 0.01$; 0.3 (0.1- 0.6), $p = 0.002$; for MMR, Hib/Men C, PCV13 and MenB respectively).

Completion Rate of immunisation at 12 months by GP surgery

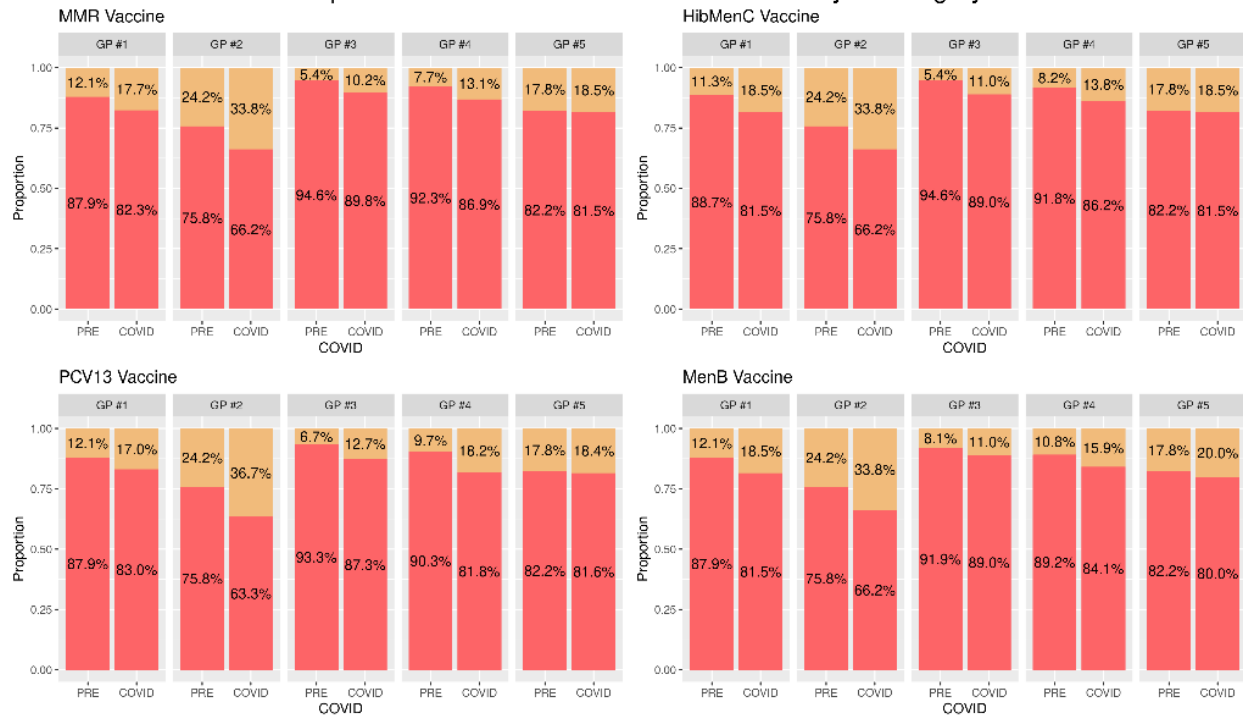

Conclusions/Learning Points: The uptake of scheduled 12-month childhood immunisations decreased during the COVID pandemic across all five GP practices in our study. Infants of Black/Black British ethnicity have been disproportionately impacted. We aim to assess further whether the drop in vaccine uptake might be due to parental concerns through a qualitative survey in the same population.

IMPACT OF COVID-19 ON ANTIMICROBIAL CONSUMPTION IN HOSPITALIZED CHILDREN

E-Posters

POSTER DISCUSSION SESSION 04: COVID EFFECTS

Dimitra Dimopoulou¹, Nikos Spyridis¹, Eirini Tzaldima², Anastasia Papaioannou³, Alexandros Douvanas³, Ekaterini Tsantila³, Irini Eleftheriou¹, Maria Tsolia⁴, Theoklis Zaoutis⁵

¹National and Kapodistrian University of Athens, Second University Department Of Pediatrics, "p. & A. Kyriakou" Children's Hospital Of Athens, Athens, Greece, ²"P. & A. Kyriakou" Children's Hospital, Pharmacy, Athens, Greece, ³"P. & A. Kyriakou" Children's Hospital, Pediatric Infectious Diseases, Athens, Greece, ⁴National and Kapodistrian University of Athens, Second Department Of Pediatrics, "p. & A. Kyriakou" Children's Hospital, Athens, Greece, ⁵National Public Health Organization, President, Athens, Greece

Backgrounds: High rates of paediatric antibiotic consumption in low and middle- income countries have been systematically documented over the years. The aim of this study is to examine the impact of COVID-19 outbreak on the antibiotic use and stewardship practices in children, as data on national and individual hospital antibiotic consumption are sparse.

Methods: This was a retrospective single-center study, that compared the antimicrobial consumption in hospitalized children between two time periods: the first period was before COVID-19 pandemic (January-December 2019) and the second during COVID-19 pandemic (January-December 2020). Antimicrobial consumption was expressed as defined daily dose (DDD) per 100 bed-days and was calculated on a 6-monthly basis.

Results: Total antibiotic consumption in 2020 (59,8 DDD per 100 bed-days) decreased by 4,4% compared to 2019 (62,6 DDD per 100 bed-days). The number of hospitalizations decreased in 2020 by 31,5%. There was an increase in the use of certain antimicrobials during 2020 (second generation cephalosporins (18,9%), carbapenems (215,8%), piperacillin/tazobactam (12,3%), and glycopeptides (11,5%) while there was a reduction in the use of ampicillin (-63,2%), amoxicillin/clavulanate (-39,1%), third generation cephalosporins (-21,5%), clindamycin (-27,6%) and aminoglycosides (-51,8%). The elevations in the DDD per 100 bed-days of carbapenems, piperacillin/tazobactam and glycopeptides were observed in the pediatric wards (117,9%, 61,1% and 45,3%, respectively) during 2020, but not in the surgical or ICU wards, where the antimicrobial consumption was at the same levels or decreased.

Conclusions/Learning Points: This study produces novel information on antimicrobial consumption in children during the COVID-19 pandemic. Further analysis linking these observational data to clinical diagnosis and co-morbidities will provide more evidence as to whether this is related to COVID-19 complications or delayed presentation of the unwell child.

DIAGNOSTIC ACCURACY OF SARS-COV-2 ANTIGEN DETECTION SELF-TEST IN CHILDREN: VIGIL STUDY 3

E-Posters

POSTER DISCUSSION SESSION 04: COVID EFFECTS

Robert Cohen¹, Stéphane Béchet¹, Camille Jung², Camille Aupiais³, Christophe Batard¹, Corinne Levy¹
¹ACTIV, Paediatrics, Créteil, France, ²CHI Créteil, Crc, Créteil, France, ³Hopital Jean Verdier, Paediatrics, Bondy, France

Backgrounds: Naso-pharyngeal RT-PCR is the gold standard for the diagnosis of COVID-19, but there is a need for rapid, suitable, reliable, and cheaper tests. With the successive epidemic waves screening remains an essential primary prevention tool and for unvaccinated children, a repeated screening strategy would identify the most infectious patient and could help to break the chains of transmission. The aim of this real-life study was to assess the performance of a SARS-CoV-2 rapid antigen self-test COVID-VIRO ALL IN® in children.

Methods: From September 1, 2021, to January 3, 2022, a cross-sectional prospective, multicenter study of 108 pediatricians in France was conducted. Symptomatic patients or children contact with a COVID-19 positive patient, aged 0 to 15 years, were recruited in the emergency department or in ambulatory settings. Each enrolled child had a SARS-CoV-2 RT-PCR or rapid antigen test, and a self-test.

Results: Among the 697 patients who performed a self-test (mean [SD] age 4.7 [3.6] years), 651 (93.4%) were symptomatic while 46 (6.6%) were contact case. The prevalence of COVID-19 was 15.1% (95% CI 12.5-17.9). False negative self-test corresponded mainly to RT-PCR with low viral loads (cycle threshold ≥ 33) and/or SARS-CoV-2 rapid antigen test positive in more than 3 minutes which corresponded mainly to a low viral load. From the age of 5 years, the self-test was easily performed by the child himself whereas for younger children, the accompanying adult (most often parents) could help. The youngest child detected with the self-test was 1 month old.

| N (%) | Sensitivity | Specificity | PPV | NPV | LR+ | LR- | Accuracy |
|--|-----------------------|-----------------------|-----------------------|-----------------------|---------------------|-----------------------|-----------------------|
| RT-PCR <30 viral Ct and/or SARS-CoV-2 rapid antigen test + | 89.1 [80.9 ; 94.7] | 99.3 [98.3 ; 99.8] | 95.3 [88.5 ; 98.7] | 98.4 [97.0 ; 99.2] | 135 [50.6 ; 359] | 0.11 [0.06 ; 0.20] | 98.0 [96.7 ; 98.9] |
| N = 92 | | | | | | | |
| RT-PCR <33 Ct and/or SARS-CoV-2 rapid antigen test + | 85.4 [76.7 ; 91.8] | 99.3 [98.3 ; 99.8] | 95.3 [88.5 ; 98.7] | 97.7 [96.2 ; 98.7] | 128 [48.2 ; 342] | 0.15 [0.09 ; 0.24] | 97.4 [95.9 ; 98.5] |
| N = 96 | | | | | | | |

Conclusions/Learning Points: In real life, these results are encouraging, with a good sensitivity and an excellent specificity, the self-test seems reliable and suitable for symptomatic children and for those contact with a COVID-19-positive person, allowing to detect contagious children.

IMPACT OF THE SARS-COV-2 PANDEMIC ON RSV EPIDEMIOLOGY IN THE CATCHMENT AREA OF A TERTIARY TEACHING HOSPITAL DEDICATED TO THE CARE OF THE 1.4-MILLION-INHABITANT-METROPOLIS OF LYON, FRANCE

E-Posters

POSTER DISCUSSION SESSION 04: COVID EFFECTS

Emilie Bard¹, Elsa Masson¹, Come Horvat¹, Chadia Toumi¹, Luc Panetta¹, Antoine Ouziel², Etienne Javouhey¹, Bruno Lina², Yves Gillet¹, Jean-Sebastien Casalegno², Dominique Ploin¹

¹Hospices Civils de Lyon - Hopital Femme Mere Enfant, Service De Reanimation Et Urgences Pediatriques, Bron, France, ²Hospices Civils de Lyon, Institut Des Agents Infectieux - Hopital De La Croix-rousse, Lyon, France

Backgrounds: RSV is a major worldwide microbial threat, and RSV-burden 2015-estimate was 33,100,000 cases of Lower-Respiratory-Tract-Infection (LRTI) in <5-year-old children, 3.2 million hospitalizations, and 118,200 deaths. RSV's seasonality is well known, usually recurring yearly in temperate climates. COVID-19 has triggered a massive implementation of Non-Pharmaceutical-Interventions (NPI) which have incidentally impacted the RSV-circulation leading in France to an atypical out-of season RSV-outbreak that we described here.

Methods: Medical records were reviewed for all hospitalized <5-year-old children with positive RSV-PCR during pre- and per-SARS-CoV-2-pandemic winter seasons. The primary objective was to describe clinical diagnosis and severity of RSV-infections during winter season between pre- and post- SARS-CoV-2-pandemic (e.g., 2019-2020, 2020-2021). Proxies for severity were: proportion of 1-4yo-children with oxygen support, for the <1-year-old-infants, incidence of very-severe LRTI (VS-LRTI; WHO-severity score). Factors associated with severity were studied.

Results: 796 patients were recruited. RSV-epidemic showed an unusual 9,3-week delay . Furthermore, the RSV-hospitalization-rate 1.8-fold-decreased, with the greatest reduction for <6mo-infants. The VS-LRTI-proportion was equally found in both pre-/perSARS-CoV-2 RSV-epidemics. In the general population, incidence rates of VS-LRTI were 378/20,418(1.85%) vs 173/20,073(0.86%). The rate of apparent-life-threatening events also decreased significantly (19%vs9%). Risk-factors for severity in the per-SARS-CoV-2-pandemic cohort were: in <6-month-old-infants, month of birth was associated with VS-LRTI (RR=1.9, 95%CI: 1.3-2.8, p<0.001); in older children, underlying-chronic disease was associated with the need for O2-support (RR=0.3, 95%CI: 0.2-0.4, p<0.001).

Conclusions/Learning Points: Implementation of Covid-19-pandemic-related NPI seems to have triggered a drastic reduction of RSV-infection-incidence in previously healthy <6month-old infants whereas older children with underlying-chronic condition remained at risk of severe disease. The presumed beneficial effect of barrier gestures suggests that preventive interventions targeted towards the youngest infant population may be a powerful preventive strategy whereas active vaccination may protect older at-risk children.

MYCOPLASMA PNEUMONIAE DETECTIONS BEFORE AND DURING THE COVID-19 PANDEMIC: RESULTS OF A GLOBAL SURVEY, 2017–2021

E-Posters

POSTER DISCUSSION SESSION 04: COVID EFFECTS

Patrick M. Meyer Sauter¹, Michael L. Beeton², Søren A. Uldum³, Nathalie Bossuyt⁴, Melissa Vermeulen⁴, Katherine Loens⁵, Sabine Pereyre⁶, Cécile Bébéar⁶, Darja Keše⁷, Jessica Day⁸, Baharak Afshar⁸, Victoria J. Chalker⁸, Gilbert Greub⁹, Ran Nir-Paz¹⁰, Roger Dumke¹¹

¹University Children's Hospital Zurich, Division Of Infectious Diseases And Hospital Epidemiology, Zurich, Switzerland, ²Cardiff Metropolitan University, Microbiology And Infection Research Group, Department Of Biomedical Sciences, Cardiff, United Kingdom, ³Statens Serum Institute, Department Of Bacteria, Parasites And Fungi, Copenhagen, Denmark, ⁴Sciensano, Epidemiology Of Infectious Diseases, Brussels, Belgium, ⁵National Reference Centre for Respiratory Pathogens, University Hospital Antwerp, Department Of Microbiology, Antwerp, Belgium, ⁶University of Bordeaux, Ea 3671, Mycoplasma And Chlamydia Infections In Humans, Bordeaux, France, ⁷Faculty of Medicine, University of Ljubljana, Institute Of Microbiology And Immunology, Ljubljana, Slovenia, ⁸London, Public Health England, London, United Kingdom, ⁹University Hospital Center and University of Lausanne, Institute Of Microbiology, Lausanne, Switzerland, ¹⁰Hadassah Hebrew University Medical Center, Department Of Clinical Microbiology And Infectious Diseases, Jerusalem, Israel, ¹¹Institute of Medical Microbiology and Virology, Tu Dresden, University Hospital Carl Gustav Carus, Dresden, Germany

Backgrounds: Mycoplasma pneumoniae respiratory infections are transmitted by aerosol and droplet particles among persons in close contact. This study investigated the global M. pneumoniae incidence after the implementation of non-pharmaceutical interventions (NPIs) against COVID-19.

Methods: We surveyed M. pneumoniae detections from laboratories and surveillance systems (national or regional) across the world from 2020-04-01 to 2021-03-31. Numbers of detections were compared with cases from corresponding periods in 2017-04-01 to 2020-03-31. Macrolide-resistant M. pneumoniae (MRMp) data were also collected from 2017-04-01 to 2021-03-31.

Results: 37 sites from 21 countries in 4 United Nations regions (Europe, Asia, America, and Oceania) submitted valid datasets (631,104 tests). A total of 30,617 M. pneumoniae detections were reported by direct test methods (62.39%; predominantly PCR), a combination of PCR and serology (34.24%; no distinction between methods), or serology alone (3.37%; IgM considered only). All countries experienced a significant reduction in M. pneumoniae incidence by direct test methods after the implementation of NPIs with 1.69%±3.30% (mean±standard deviation) compared to 8.61%±10.62% during 04/2017–03/2020 (P<0.01). Detection rates decreased with direct but not with indirect test methods (serology) (–93.51% vs. +18.08%; P<0.01). Direct detections remained remarkably low worldwide throughout 04/2020–03/2021 despite widely differing lockdown or school closure periods. MRMp was reported from 7 sites (Europe, Asia, and America) and detected in 4.55% (n=1/22) of investigated cases in 04/2020–03/2021 and 23.10% (n=176/762) during 04/2017–03/2020 (P=0.04).

Conclusions/Learning Points: This is the most comprehensive collection of M. pneumoniae detections worldwide showing a correlation between COVID-19 NPIs and a significantly reduced number of M. pneumoniae detections.

ASSOCIATION BETWEEN THE COVID-19 PANDEMIC AND PERTUSSIS IN FRANCE USING MULTIPLE NATIONWIDE DATA SOURCES

E-Posters

POSTER DISCUSSION SESSION 04: COVID EFFECTS

Soraya Matczak^{1,2}, Corinne Levy^{3,4,5,6,7}, Camille Fortas⁸, Jérémie F Cohen^{2,9}, Stéphane Béchet⁷, Fatima Ait El Belghiti⁸, Sophie Guillot¹⁰, Sabine Trombert-Paolantoni¹¹, Véronique Jacomo¹², Yann Savitch⁸, Juliette Paireau^{8,13}, Sylvain Brisse^{1,10}, Nicole Guiso¹⁴, Daniel Levy-Bruhl⁸, Robert Cohen^{3,5,6,7,15,16}, Julie Toubiana^{1,2,5,10}

¹Institut Pasteur, Biodiversity And Epidemiology Of Bacterial Pathogens, Paris, France, ²Necker Enfants malades Hospital, General Pediatrics And Pediatric Infectious Diseases, Paris, France, ³Université Paris Est, Imrb-grc Gemini, Créteil, France, ⁴ACTIV, Association Clinique Et Thérapeutique Infantile Du Val-de-marne, Créteil, France, ⁵GPIP, Groupe De Pathologie Infectieuse Pédiatrique, Paris, France, ⁶AFPA, Association Française De Pédiatrie Ambulatoire, Saint Germain en Laye, France, ⁷Centre Hospitalier Intercommunal de Créteil, Clinical Research Center, Créteil, France, ⁸The French Public Health Agency, Infectious Diseases Department, Saint Maurice, France, ⁹INSERM, Obstetrical, Perinatal And Pediatric Epidemiology Research Team, Paris, France, ¹⁰Institut Pasteur, National Reference Center For Whooping Cough And Other Bordetella Infections, Paris, France, ¹¹Laboratoire CERBA, Cerba, Saint Ouen l'Aumône, France, ¹²Laboratoire Eurofins Biomnis, Eurofins Biomnis, Lyon, France, ¹³Institut Pasteur, Mathematical Modelling Of Infectious Diseases Unit, Paris, France, ¹⁴Institut Pasteur, Institut Pasteur, Paris, France, ¹⁵Centre Hospitalier Intercommunal de Créteil, Unité Court Séjour, Petits Nourrissons, Service De Néonatalogie, Créteil, France, ¹⁶ACTIV, Paediatrics, Créteil, France

Backgrounds: Interventions to mitigate coronavirus disease 19 (COVID-19) pandemic may impact other respiratory diseases such as pertussis. We aimed to study the course of pertussis in France over an 8-year period and its association with COVID-19 mitigation strategies, using multiple nationwide data sources and regression models.

Methods: We analyzed the number of French pertussis cases between 2013 and 2020, using the PCR test results from nationwide outpatient laboratories (Source 1) and the pediatric network of 41 hospitals (Source 2). We also used the reports of an office-based pediatric national network (Source 3). We conducted a quasi-experimental interrupted time-series analysis, relying on negative binomial regression models. The models accounted for seasonality, long-term cycles, and secular trend, and included a binary variable for the first national lockdown (ordered on March 16, 2021).

Results: We identified 19,039 cases of pertussis from the three data sources during the study period. There was a significant decrease of pertussis cases following the implementation of mitigation measures, with adjusted incidence rate ratios of 0.102 (95% CI 0.040-0.256) and 0.216 (95% CI 0.071-0.656) for Source 1 and Source 2, respectively. The association was confirmed in Source 3 (median of 1 [IQR 0-2] vs. 0 [IQR 0-0] pertussis cases per month before and after lockdown, respectively, $p=0.0048$).

Conclusions/Learning Points: The drastic reduction of outpatient and hospitalized cases of pertussis suggests an impact of COVID-19 mitigation measures and their consequences on pertussis epidemiology. Pertussis vaccination recommendations should be carefully followed, and disease monitoring should be continued to detect any resurgence after relaxation of mitigation measures.

CLINICAL OUTCOME IN NEWBORNS OF PERINATALLY COVID-19 INFECTED WOMEN

E-Posters

POSTER DISCUSSION SESSION 04: COVID EFFECTS

Garyfallia Syridou¹, Eleni Kapsabeli², Artemis Mavridi¹, Despoina Gkentzi³, Vassiliki Sideri², Aggeliki Vervenioti³, Nikolaos Siafakas⁴, Anna Daskalaki², Despoina Briana², Vassiliki Papaevangelou⁵

¹National and Kapodistrian University of Athens, Third Department Of Pediatrics, Attikon University Hospital, Athens, Greece, ²National and Kapodistrian University of Athens, Neonatal Intensive Care Unit, Third Department Of Pediatrics, Attikon University Hospital, Athens, Greece, ³Patras Medical School, University of Patras, Department Of Paediatrics, Patras, Greece, ⁴Attikon University Hospital, Microbiology Department, Athens, Greece, ⁵National and Kapodistrian University of Athens, Third Demartment Of Paediatrics, Attikon University Hospital, Athens, Greece

Backgrounds: Neonatal outcomes post-perinatal maternal COVID-19 infection remain under study. Our aim is to present the outcome of neonates born to mothers with perinatal SARS-CoV-2 infection in Greece.

Methods: We performed a prospective cohort study in two Academic Tertiary Referral Hospitals in Greece (March 2020 to April 2021). Data concerning maternal age, nationality, comorbidities, characteristics of maternal SARS-CoV-2 infection were recorded. Additionally, gestational age (GA), mode of delivery, birth weight (BW), need for resuscitation or supplemental oxygen, and management during hospitalization were recorded. A comparison with 2:1 matched neonates according to sex, GA, and BW born to SARS-CoV-2 negative mothers was performed.

Results: Seventy nine pregnant SARS-CoV2 PCR positive at delivery women gave birth to 81 neonates. Median maternal age was 30.5 years (IQR 24-34 years) and with no comorbidities (65.8% and 64% respectively). Fifty seven percent of pregnant mothers were symptomatic and treatment was given to 22% of them. A high rate of prematurity (24.7%) was reported in the COVID + cohort (24.7% vs 21.2%) and significantly more deliveries were performed via CS in COVID+ pregnancies when compared to the control group ($p=0,024$). In terms of neonates born to PCR + mothers the median GA and BW were 38 weeks (IQR 39-36 weeks) and 2940 gr (IQR 3340-2560 gr) respectively. Only 2 (2.4%) neonates were PCR positive. Gastrointestinal problems were more common in neonates born to COVID + mothers ($p=0,00$). The use of antibiotics did not differ between the two groups, while hospitalization duration was longer in the first group (median 10 and 4 days respectively, $p=0,000$).

Conclusions/Learning Points: No vertical transmission was noted. However the presence of gastrointestinal symptoms in neonates born to PCR positive women compared to controls needs further investigation.

PD089 / #907

CHANGE IN FRENCH PEDIATRIC BACTERIAL MENINGITIS RESULTING FROM VACCINATION AND COVID-19 PANDEMIC

E-Posters

POSTER DISCUSSION SESSION 04: COVID EFFECTS

Corinne Levy¹, Emmanuelle Varon², Stéphane Béchet¹, Alexis Rybak¹, Naim Ouldali¹, Robert Cohen¹
¹ACTIV, Paediatrics, Créteil, France, ²CHI Créteil, Microbiology, Créteil, France

Backgrounds: The epidemiology of bacterial meningitis in children have changed after the introduction of vaccines against the involved bacteria. We used the ongoing bacterial meningitis surveillance to investigate whether the COVID-19 pandemic has impacted on the distribution of pathogens involved.

Methods: Since January 2001 to December 2020, 233 pediatric wards (covering 68% of French towns) and 166 microbiologic departments recorded clinical and biological characteristics of children with bacterial meningitis.

Results: Among the 7,360 cases, the most frequent bacteria was *Neisseria meningitidis* (Nm) 44.3% in 2001, before the implementation of MenC vaccine followed by *Streptococcus pneumoniae* (Sp) (28.1%). After PCV13 implementation, the decrease of Sp cases was followed by an increase due to the emergence of Non-PCV13 serotypes (particularly the serotypes 24F, 10A 15BC and 23B) : Sp became the first bacteria involved in bacterial meningitis (33.9% in 2019). After the first 10 months of the COVID-19 pandemic, in 2020, a dramatic decrease of Nm and Sp meningitis was observed while Group B *Streptococcus* (GBS) and *E Coli* remained stable over the 20 study years. In 2020, the distribution of meningitis pathogens has changed with Sp (22.9%) as the most frequent followed by GBS (20.2%), Nm (15.7%), and *E coli* (14.8%).

Conclusions/Learning Points: Over the past 2 decades, the epidemiology of pediatric bacterial meningitis has been modified and GBS has become the second most common pathogen involved. The hypothesis that the immune debt will change again this picture remains to be evaluated as soon as possible.

ANTIMICROBIAL PRESCRIBING IN HOSPITALIZED CHILDREN WITH COVID-19

E-Posters

POSTER DISCUSSION SESSION 04: COVID EFFECTS

Dimitra Dimopoulou¹, Nikos Spyridis¹, Irini Eleftheriou¹, Marianthi Liaska¹, Foteini Dasoula¹, Aggeliki Syggelou¹, Theoklis Zaoutis², Maria Tsolia¹

¹National and Kapodistrian University of Athens, Second University Department Of Pediatrics, "p. & A. Kyriakou" Children's Hospital Of Athens, Athens, Greece, ²National Public Health Organization, President, Athens, Greece

Backgrounds: Antimicrobial consumption has increased during the COVID-19 pandemic especially in hospitalized adults with COVID-19. This study aims to analyze the co-infections, prevalence and characteristics of antimicrobial use in hospitalized children with COVID-19.

Methods: A single-center retrospective study was performed between March 2020 and December 2021 in children admitted to a COVID-19 referral pediatric hospital, following a positive RT-PCR for SARS-CoV-2. Medical records of children with COVID-19 were reviewed for demographics, clinical characteristics and data on antimicrobial administration.

Results: A total of 299 children with confirmed COVID-19 were enrolled. Antimicrobial use was documented in 75 (25%) patients (male:53,3%; median age:4 years, IQR:12). The median duration of hospitalization was 5 days and the mean duration of antimicrobial use was 5 days. The most frequently prescribed antimicrobials were penicillins (36%), cefotaxime (24%), ampicillin plus gentamicin (16%) and macrolides (13,3%). Secondary bacterial infection or co-infection was reported in 26,6% of children who received antimicrobials. Antimicrobials were administered in 41,3% of children with severe disease (mean antimicrobial duration: 5 days), in 58,3% with abnormal chest imaging and in 32% with increased C-reactive protein (>60mg/L). A mean of 1.2 antimicrobials was prescribed per patient and they were stopped or de-escalated within 72 h in 48%, without supporting clinical, radiological or laboratory evidence of bacterial infection, while in 29,3% of these were neonates.

Conclusions/Learning Points: 25% of hospitalized children with COVID-19 received antimicrobials for suspected bacterial. Most patients received narrow spectrum antibiotics. Diagnostic criteria should be applied to avoid unnecessary prescribing in the context of COVID-19 infection.

PD091 / #775

CLINICAL IMPACT AFTER IMPLEMENTATION OF AN ANTIMICROBIAL STEWARDSHIP PROGRAM AND A JOINT ELECTRONIC PROTOCOL FOR THE MANAGEMENT OF PATIENTS WITH APPENDICITIS AND/OR PERITONITIS IN PEDIATRICS

E-Posters

POSTER DISCUSSION SESSION 05: ANTIMICROBIALS & ANTIBIOTIC STEWARDSHIP

Serena Villaverde¹, Patricia Brañas², José Manuel Caro³, Rocío Morante⁴, Irene Gómez¹, Gloria Mirete¹, Cinta Moraleda¹, Daniel Blázquez-Gamero¹, Angela Manzanares¹, David Torres¹, Elisa Fernandez¹, Luis Prieto¹, Pablo Rojo¹, Cristina Epalza¹

¹HOSPITAL 12 DE OCTUBRE, Paediatrics, MADRID, Spain, ²HOSPITAL 12 OCTUBRE OCTUBRE, Microbiology, Madrid, Spain, ³HOSPITAL 12 OCTUBRE OCTUBRE, Farmacology, Madrid, Spain, ⁴HOSPITAL 12 OCTUBRE, Pediatric Surgery, Madrid, Spain

Backgrounds: Appendix-related intraabdominal infections are common surgical pathologies in children. Initial antibiotic treatment significantly reduces wound infection and intra-abdominal abscess formation in patients with gangrenous or perforated appendicitis. Randomized controlled trials have shown that the use of lower-spectrum antibiotic combinations is as effective in preventing abscesses or surgical wound infections as broad-spectrum regimens.

Methods: Observational, retrospective study of patients <16 years of age admitted for appendicitis and/or peritonitis from Jan/2014 to Dec/2019 in a tertiary university hospital in Madrid, Spain. Three study periods were established: P1 2014-2015 (before Antimicrobial Stewardship Programme (ASP)), P2 2016-2018 (ASP implemented) and P3 Jan/2019-Dec/2019 (ASP and implementation of a appendicitis/peritonitis protocol with electronic prescribing, including lower-spectrum antibiotic combinations and selected and clinically guided use after surgery). Demographic, clinical and infectious complications after surgery data were collected.

Results: 1619 patients were included. A total of 137 (8.5 %) patients developed infectious complications, with a median of 20.5 infectious complications per period (IQR 19-22.8). The most frequent complication was intra-abdominal abscesses (101/137, 73.7%). In P1, P2 and P3 the rate of intra-abdominal abscesses per period was 7.6%, 9.8% and 6.2% respectively (p=0.573). Regarding the length of hospital stay, the percentage of patients who remained hospitalized for ≤5 days increased during the study periods: 67.6% in P1, 70.7% in P2, and 82.7% in P3 (p<0.001).

Conclusions/Learning Points: After the implementation of an ASP and a lower-spectrum antibiotic protocol with electronic prescribing and a clinically guided use after surgery, the proportion of infectious complications after surgery for appendicitis/peritonitis remained stable. In parallel, the proportion of patients who were hospitalized for 5 days or less increased in the period with an electronic prescribing tool implemented with the ASP.

PD092 / #1117

SAFETY OF DAPTOMYCIN IN CHILDREN, PRELIMINARY RESULTS OF A SYSTEMATIC REVIEW

E-Posters

POSTER DISCUSSION SESSION 05: ANTIMICROBIALS & ANTIBIOTIC STEWARDSHIP

Kevin Meesters¹, Arangan Kirubakaran², Srinivasa Rambhatla³

¹BC Children's Hospital/University of British Columbia, Department Of Pediatrics Infectious Diseases, Vancouver, Canada, ²St Mary's Hospital- Imperial College Healthcare NHS trust, Department Of Paediatric Infectious Diseases And Immunology, London, United Kingdom, ³The Hillingdon Hospitals NHS Foundation, Paediatrics, London, United Kingdom

Backgrounds: Rising antimicrobial resistance compels the use of reserved antibiotics. Since clinical studies in children are scarce, we investigated the safety of daptomycin in children through a systematic literature review.

Methods: PubMed, Medline, CINAHL and Cochrane were searched for relevant studies, using a predefined strategy. Any report in English, except for narrative reviews, was eligible for inclusion. For the purpose of this preliminary analysis, a qualitative synthesis of available evidence is presented. Two reviewers independently reviewed all abstracts for inclusion.

Results: Data from 25 studies including a total of 1882 children within all age categories was reviewed: 19 case reports/series, 3 randomized controlled trials, 2 cohort studies, and 1 previous systematic review. In most case reports, daptomycin was used as rescue therapy after therapy failure with other antibiotics. Furthermore, side effects were often not described in case reports. In the cohort studies, increases in alanine-aminotransferase (ALT), aspartate-aminotransferase (AST) and creatine phosphokinase (CPK) during therapy were described, which in all cases resolved after treatment discontinuation. In the RCTs, adverse effects of daptomycin were generally less frequent than in the comparison group and included diarrhoea, Candida infections, headaches and myalgia. Infusion reactions and anaphylaxis were occasionally reported. One case study reported therapy failure in an adolescent with MRSA sepsis, but underdosing might have contributed to this.

Conclusions/Learning Points: The available evidence suggests that daptomycin is well tolerated in children. The most common side effects include reversible biochemical abnormalities, diarrhoea, headaches and myalgia, but all these incidences are relatively low. Nevertheless, since uncommon side effects can only be observed in larger populations, ongoing pharmacovigilance is required.

PD093 / #1544

**IMPACT OF ANTIBIOTIC STEWARDSHIP GUIDELINES IMPLEMENTATION ON THE
ANTIMICROBIAL PRESCRIPTION IN PRIMARY CARE SETTING: AN OBSERVATIONAL STUDY**

E-Posters

POSTER DISCUSSION SESSION 05: ANTIMICROBIALS & ANTIBIOTIC STEWARDSHIP

Federica Pagano, Chiara Amato, Sara Maria Scarano, Rita Nunziata, Maria Micillo, Gaetano Cecere, Giulio De Marco, Andrea Lo Vecchio
University of Naples, Federico II, Department Of Translational Medical Sciences - Section Of Pediatrics, Naples, Italy

Backgrounds: In 2018 Campania region developed and implemented recommendations for antimicrobial stewardship following the National Plan to contrast Antibiotic-Resistance. The prescription of third-generation Cephalosporins and Fluoroquinolones exceeded the national average. We aimed to assess the impact of guidelines on primary-care paediatrician's attitude towards antimicrobial prescription.

Methods: We performed a retrospective open-cohort study (Jan 2016 to Dec 2020), including all patients registered in an associated paediatric primary-care practice. Antibiotic prescriptions data were collected from the clinical management software. Primary outcomes were the prescription rate per number of patients and per medical consultations and the proportion of three antibiotic classes (Macrolides, Fluoroquinolones and third-generation Cephalosporins) over the total number of prescriptions.

Results: During the study period, 2599 children (median age 5.47 years, IQR 6.08) received 11364 antibiotic prescriptions with 4.37 prescriptions (0.87/year) for patient, on average. The annual prescription rate/100 patients decreased from 9.33 (95%CI 9.00-9.66) in 2016 to 3.39 (95%CI 3.19-3.59) in 2020, the annual prescription rate/100 medical consultations decreased from 25.49 (95%CI 24.60-26.41) to 15.98 (95%CI 15.05-16.95). A clear trend in reduction of prescriptions for patient in follow-up ($R^2=0.993$) and medical consultation ($R^2=0.936$) was seen even before COVID-19 pandemic, that mainly affected the prescription rate in the first months of lockdown. The proportion of third-generation Cephalosporins on the total number of prescriptions varied from 789/3107 (25%) in 2016 to 146/1093 (13%) in 2020 ($p<0.001$). The prescription of fluoroquinolones (8/3107, 0.25% to 2/1093 0.18%, $p=0.104$) and macrolides (484/3107, 15% to 166/1093, 15%, $p=0.759$) did not vary over time.

Conclusions/Learning Points: The overall antibiotic prescription rate per 100-patient and per 100-medical consultations significantly decreased following regional guidelines implementation, with a significant reduction of third-generation Cephalosporins and a trend in reduction of fluoroquinolones.

PD094 / #351

RESISTENCE PATTERNS OF SENTINEL ORGANISMS IN A TERTIARY LEVEL CHILDREN'S HOSPITAL IN THE UK OVER 20 YEARS

E-Posters

POSTER DISCUSSION SESSION 05: ANTIMICROBIALS & ANTIBIOTIC STEWARDSHIP

Luca Zombori¹, James Hatcher², Stéphane Paulus³

¹Great Ormond Street Hospital for Children, Paediatric Intensive Care Unit, London, United Kingdom, ²Great Ormond Street Hospital for Children, Department Of Microbiology, London, United Kingdom, ³University of Oxford, Paediatric Infectious Diseases, Oxford, United Kingdom

Backgrounds: Following antibiotic resistance is a cornerstone of antimicrobial stewardship activity. We have monitored *P.aeruginosa*, Enterobacterales, VRE and MRSA on the intensive care units of a tertiary level paediatric hospital in London, United Kingdom over 20 years, plotted and compared against the English Surveillance Program for Antimicrobial Utilisation and Resistance (ESPAUR) data.

Methods: Retrospective analysis of prospectively collected laboratory data of all clinical isolates and of blood cultures only. Samples considered resistant if resistance was 50% or higher. Samples from the same patients were only considered if at least 365 days apart to avoid recording duplicate samples from the same clinical episode. Results were anonymised and analysed in Excel.

Results: Resistance is higher in the examined hospital compared to ESPAUR. *P.aeruginosa* resistance against combined piperacillin-tazobactam+ciprofloxacin in 2011-12 reached 35.5%, although decreasing since. *E.coli* resistance against the same combination was 16.7% in 2005-6 although decreasing since. VRE was 20% in 2017-18, comparable to ESPAUR's, but overall only 1%. MRSA was overall very high of 13%, but the 2019-20 value of 7.1% is comparable with ESPAUR's 6%.

Conclusions/Learning Points: The fact that resistance in this hospital is at points higher than the national values gives food for thought. A possible explanation is a unique patient group with complex background conditions with long and repeated inpatient (an intensive care) stays, many of whom are international from areas of higher antibiotic resistance. Regardless of the cause, the results help guide further antimicrobial stewardship efforts.

DETERMINANTS OF ANTIBIOTIC PRESCRIPTIONS IN A LARGE COHORT OF CHILDREN DISCHARGED FROM A PEDIATRIC EMERGENCY DEPARTMENT

E-Posters

POSTER DISCUSSION SESSION 05: ANTIMICROBIALS & ANTIBIOTIC STEWARDSHIP

Danilo Buonsenso

Fondazione Policlinico Universitario A. Gemelli IRCCS, Pediatrics, Roma, Italy

Backgrounds: This study aimed at defining the demographic, social, clinical, and laboratory factors that affect antibiotic prescriptions in children discharged from the emergency department

Methods: retrospective observational study of children aged younger than 18 years discharged from a pediatric university hospital (01/01/2015-31/12/2020). We determined the proportion and type of antibiotic prescription according to demographic, social, clinical, laboratory and imaging data, as well as doctor's expertise.

Results: Overall 51,633 children were included, 13,167 (25.5%) received an antibiotic prescription. Am/Cl (Am/Cl) was the most prescribed antibiotic (8453, 64.2% of all prescriptions). Factors independently associated with an antibiotic prescription were: older age (OR= 1.62 [1.53–1.73] for age 2-5 yy, OR=1.77 [1.64–1.91], OR=1.36 [1.25–1.49] for age 11-18 yy, $p < 0.001$ for all groups); being evaluated by a physician with > 3 years of pediatric expertise (OR=1.22 [1.13–1.31], $p < 0.001$); fever peak higher than 40°C (OR=1.37 [1.21–1.54], $p < 0.001$); abnormal findings on auscultation (OR=1.95 [1.75–2.17], $p < 0.001$); CRP values (OR=1.63 [1.26–2.10] for CRP<50mg/dL, and OR=3.78 (2.75–5.21) for CRP≥50 mg/dL with respect to CRP not requested); CXR results whatever positive (OR=4.47 [3.62–5.52], $p < 0.001$), or negative (1.82 [1.62 – 2.04], $p < 0.001$); being diagnosed with upper respiratory tract infections (OR=4.27 [4.04 – 4.51], $p < 0.001$), lower respiratory tract infections (OR=5.35 [4.88 – 5.85]; $p < 0.001$), and UTI (OR=9.33 [8.14 – 10.71], $p < 0.001$). Am/Cl was significantly more prescribed in older children, by more experienced doctors, with fever peak >40°C, positive chest X-ray, and with skin infections.

Conclusions/Learning Points: Overprescription of antibiotics, including wide-spectrum ones, is relevant in pediatric emergency departments. Factors associated with overprescription are not limited to the clinical characteristics of the treated patients, but also include environmental variables, doctor's expertise, and attitudes to laboratory and radiological examinations.

DESCRIPTION OF EPIDEMIOLOGICAL AND GENETIC CHARACTERISTICS OF VANCOMYCIN-RESISTANT ENTEROCOCCUS FAECIUM ISOLATES IN A UNIVERSITY CHILDREN'S HOSPITAL IN GERMANY – 2019 TO 2020

E-Posters

POSTER DISCUSSION SESSION 05: ANTIMICROBIALS & ANTIBIOTIC STEWARDSHIP

Laura Kolberg¹, Ilona Trautmannsberger^{1,2}, Melanie Meyer-Buehn¹, Johannes Huebner^{1,3}, Guido Werner⁴, Robert Weber⁴, Valerie Heselich⁵, Sebastian Schröpf⁵, Ulrich Von Both^{1,3}

¹Dr. von Hauner Children's Hospital, Division Of Paediatric Infectious Diseases, Munich, Germany, ²Institute for Medical Information Processing, Biometry, and Epidemiology, Ibe, Munich, Germany, ³Institut German Centre for Infection Research (DZIF), Infection Research, Munich, Germany, ⁴Robert Koch Institute, Wernigerode Branch, Wernigerode, Germany, ⁵Dr. von Hauner Children's Hospital, LMU University Hospital, Munich, Germany, Division Of Neonatology, Munich, Germany

Backgrounds: Due to limited treatment options and an increased risk for acquisition in immunocompromised children, surveillance to monitor occurrence of VREfm in paediatric clinical facilities is of critical importance. Following an unusual accumulation of VREfm positive patients between April 2019 and August 2020 at the Hauner Children's Hospital in Munich, Germany, our study aimed to identify dynamics and routes of transmission, and analyse the affected population.

Methods: Hospital database was used to collect epidemiological and clinical data of VREfm cases. Descriptive statistical analyses were conducted to outline patient characteristics and depict possible differences between VREfm-colonised and -infected children. Outbreak investigation determining genetic relatedness among VREfm isolates was performed by core genome multilocus sequence typing (MLST). To examine potential transmission pathways, results of genome analysis were compared with epidemiological and clinical data of VREfm positive patients.

Results: VREfm acquisition was documented in 33 children (< 18 years). Seven VREfm-colonised patients (21.2%), especially those with a haemato-oncological disease (4/7; p=0.011), showed signs of clinical infection. MLST analyses revealed seven distinct clusters, demonstrating a possible connection within each clonal lineage. Eight singletons were identified. Comparison with epidemiological and clinical data provided strong evidence for a link between several VREfm positive patients within the hospital.

Conclusions/Learning Points: A nosocomial spread – at least in part – was the most likely reason for the unusual accumulation of VREfm cases at the Hauner Children's Hospital. This study highlights that there is a constant need to increase efforts in hygiene measures, infection control and antibiotic stewardship to combat VREfm transmission events within German paediatric hospitals. Continuous monitoring of adherence to respective infection control policies might reduce the occurrence of clustered cases and prevent future outbreaks.

ANTIMICROBIAL ACTIVITIES OF GALACTO- AND FRUCTO-OLIGOSACCHARIDES AGAINST MYCOPLASMA PNEUMONIAE AND STREPTOCOCCUS PNEUMONIAE

E-Posters

POSTER DISCUSSION SESSION 05: ANTIMICROBIALS & ANTIBIOTIC STEWARDSHIP

Wendy Unger¹, Hongzhen Zhu², Lisa Slimmen², Yang Cai³, Ad De Bruijn¹, Annemarie Van Rossum⁴, Gert Folkerts⁵

¹Erasmus MC Sophia Children's Hospital, Pediatrics - Laboratory Of Pediatrics, Rotterdam, Netherlands, ²Erasmus MC Sophia Children's Hospital, Pediatrics - Laboartory Of Pediatrics, Rotterdam, Netherlands, ³Utrecht University, Division Of Pharmacology, Utrecht Institute For Pharmaceutical Sciences, Faculty Of Science, Utrecht, Netherlands, ⁴Erasmus MC (University Medical Center Rotterdam), Department Of Pediatrics, Division Of Pediatric Infectious Diseases And Immunology, Rotterdam, Netherlands, ⁵Utrecht University, Division Of Pharmacology, Utrecht Institute For Pharmaceutical Sciences, Faculty Of Science, Rotterdam, Netherlands

Backgrounds: Effective treatment of bacterial infections is threatened by antibiotic resistance. Antibiotic resistance delays adequate treatment and often results in increasing morbidity and mortality. Mycoplasma pneumonia (Mp) and Streptococcus pneumoniae (Sp) are frequent causes of respiratory infections in children, and known for increasing resistance rates. Evidently, alternative treatments are warranted. Non-digestible oligosaccharides (NDOs), a specific group of complex carbohydrates have recently gained profound interest due to anti-infective and/or antimicrobial capabilities. In the current study we investigated the potential of galacto-oligosaccharides (GOS) and fructo-oligosaccharides (FOS) as alternative for antibiotic treatment.

Methods: GOS and FOS were added in graded concentrations (1-16%) to Sp and Mp strains. Inhibition of the growth and killing of bacteria was tested using Minimum inhibitory concentration (MIC) and minimum bactericidal concentration (MBC) assays. Effect of NDOs on bacterial adhesion was evaluated in co-cultures with respiratory epithelial A549 cells. Conventional antibiotics were used as control.

Results: The MIC of GOS for Mp and Sp was 4% and 8%, respectively. The MIC of FOS was 16% and 8%, respectively. Only GOS exhibited bactericidal effects with an MBC of 4%. Addition of GOS prevented adhesion of Mp to A549 in a dose-dependent manner, with 8%GOS inhibiting 80% of Mp adhesion as compared to control. In contrast, 8%FOS only inhibited 17% of Mp adhesion. GOS also proved effective when bacteria are already adhered onto A549: a 55% reduction in the number of Mp on A549 was measured. Importantly, under these conditions 60% Mp were killed.

Conclusions/Learning Points: FOS and GOS can inhibit the growth of Mp and Sp. Further, GOS can also kill the bacteria and function as anti-infective agent. These promising effects of FOS and GOS may offer new opportunities to treat airway infections.

ANTIBIOTIC STEWARDSHIP FOR EARLY-ONSET SEPSIS IN EXTREMELY PRETERM BABIES

E-Posters

POSTER DISCUSSION SESSION 05: ANTIMICROBIALS & ANTIBIOTIC STEWARDSHIP

Nisreen Khambati¹, Mark Anthony²

¹Royal Berkshire NHS Foundation Trust, Paediatrics, Oxford, United Kingdom, ²Oxford University Hospitals NHS Foundation Trust., Neonatal Intensive Care Unit, DU, United Kingdom

Backgrounds: Extremely preterm infants (under 28 weeks) are vulnerable to early-onset sepsis (EOS) and timely administration of antibiotics is important. However, there are serious complications associated with antimicrobial use such as necrotising enterocolitis, and antibiotic stewardship is important.

Methods: We conducted a prospective surveillance of antibiotics administered to extremely preterm infants within the first 48 hours of life in a tertiary neonatal unit in the UK between November 2020 and February 2021. Our objective was to determine the extent of antibiotic use and whether escalation to second-line antibiotics was appropriate based on local guidelines and national recommendations.

Results: 22 infants were born at ≤ 28 weeks' gestational age during the observation period. All were started on benzylpenicillin and gentamicin. 8/22 babies were switched to 2nd line antibiotics within 48 hours. Of these, 4 were appropriately escalated to cefotaxime and amoxicillin due to concerns regarding meningitis. 1 baby had metronidazole added for abdominal pathology following discussion with a consultant neonatologist. 3 babies were escalated to inappropriate 2nd line antibiotics: 1 baby received vancomycin due to rising inflammatory markers and presence of a long line, 1 clinically stable baby was given meropenem due to a skin infection and 1 baby who deteriorated was switched to amikacin.

Conclusions/Learning Points: Local guidelines help ensure appropriate antibiotic use for EOS however ongoing education is needed regarding reserving vancomycin for proven coagulase-negative staphylococci infections, which typically occur after 48 hours of life, and meropenem for life-threatening deteriorations. Meropenem will cover ESBL-related EOS, which is often gentamicin-sensitive, even if cefotaxime-resistant. For most other situations, cefotaxime + amoxicillin are appropriate 2nd line antibiotics for EOS. Multidisciplinary meetings between neonatologists and infectious disease specialists attended by junior doctors could help promote stewardship in neonatal units.

PD099 / #614

EVALUATING THE APPROPRIATENESS OF EMPIRICAL USE OF CEFEPIME AND PIPERACILLIN/TAZOBACTAM USING DRUG UTILIZATION EVALUATION IN PEDIATRIC PATIENTS

E-Posters

POSTER DISCUSSION SESSION 05: ANTIMICROBIALS & ANTIBIOTIC STEWARDSHIP

Sophida Boonsathorn, Priengrutai Prasopchoknapaporn, Chonnamet Techaseansiri, Nopporn Apiwattanakul, Sujittra Chaisavaneeyakorn
Faculty of Medicine Ramathibohi Hospital, Department Of Pediatrics, Bangkok, Thailand

Backgrounds: Cefepime and piperacillin/tazobactam are often used inappropriately due to their broad-spectrum activity. Drug utilization evaluation (DUE) is a systemic, criteria-based assessment aimed to optimize the appropriateness of antibiotic use. This study aimed to evaluate the performance of DUE on cefepime and piperacillin/tazobactam prescriptions in pediatric patients.

Methods: This study was conducted at the Department of Pediatrics, Ramathibodi Hospital, Bangkok, Thailand, between March 2020 and August 2021. All children aged 1 month to 20 years who received at least 1 dose of cefepime or piperacillin/tazobactam were enrolled. For the first period (March 2020 to February 2021), cefepime and piperacillin/tazobactam were prescribed without the DUE form and retrospectively evaluated the prescription appropriateness using DUE criteria. For the second period, a quasi-experimental study was implemented over 6 months (March to August 2021) using a DUE form with voluntary use. Demographic data and antibiotic therapy were collected from medical records.

Results: There were 304 prescriptions of cefepime and piperacillin/tazobactam, with 108 empirical prescriptions (72 patients) in the DUE group and 158 prescriptions (138 patients) in the non-DUE group. The overall appropriateness of indications was significantly higher in the DUE group (93.5% vs. 83.5%; p-value=0.003). Additionally, DUE was significantly associated with appropriate empirical prescriptions (adjusted OR 5.32: 95%CI 1.80-15.73; p-value=0.003), whereas being in critical care wards and having urinary tract infections (UTIs) appeared to be associated with deviation from DUE criteria for appropriateness. Regardless of ID consultation, using the DUE form remained associated with appropriate empirical prescriptions (adjusted OR 4.8: 95%CI 1.32-12.8; p-value=0.016).

Conclusions/Learning Points: DUE could improve the appropriateness of cefepime and piperacillin/tazobactam prescriptions in pediatric patients. Patients in the critical care unit and with UTIs appeared to be associated with inappropriate empirical treatment.

COMPARISON OF ANTIMICROBIAL CONSUMPTION IN CRITICALLY ILL CHILDREN USING DAILY DEFINED DOSES AND DAYS OF THERAPY

E-Posters

POSTER DISCUSSION SESSION 05: ANTIMICROBIALS & ANTIBIOTIC STEWARDSHIP

Kyriaki Moustakidou Papadaki¹, Areti Nikolaidou¹, Christos Paschaloudis¹, Elisavet Chorafa¹, Konstantinos Pavlogiannis¹, Elias Iosifidis¹, Eleni Ifigenia Christou², Maria Sdougka³, Emmanuel Roilides¹

¹Aristotle University of Thessaloniki, Infectious Diseases Unit, 3rd Pediatric Department, Thessaloniki, Greece, ²Hippokration Hospital of Thessaloniki, Hospital Pharmacy, Thessaloniki, Greece, ³Hippokration Hospital of Thessaloniki, Pediatric Intensive Care Unit, Thessaloniki, Greece

Backgrounds: Although antimicrobial use monitoring is essential, computerized clinical records at patient level may not be available in many countries. Days of Therapy (DOTs) are recommended by WHO as an antimicrobial consumption metric but access to patient level data is required. We compared daily-defined doses (DDD) to DOTs as antibiotic consumption metrics in critically ill children and evaluated their relation.

Methods: Data on antimicrobial consumption in a pediatric intensive care unit (PICU) from June 2018 to December 2019 were expressed as monthly DDDs per 100bed-days (DDD/100BD) and monthly DOTs/100BD. All analyses were performed in R version4.0.4. The time series of DOTs and DDDs were examined for evidence of seasonality, stationarity and autocorrelation. A linear regression model was developed to predict DOTs/100BD using DDDs/100BD for total antimicrobial consumption and for specific antimicrobials.

Results: During study period 178 admissions occurred. After adjusting for trend, seasonality and autocorrelation, a strong correlation was found between the two metrics of total antimicrobial use ($r=0.68$, $p=0.001$, Table1). The linear regression model for these two metrics use was: coefficient $\beta=0.66$ (0.45-0.88), $p<0.001$. Correlation between DDDs/100BD and DOTs/100BD varied among commonly used antimicrobial agents.

| Antimicrobial | Pearson's r | r 95% CI | R squared |
|--------------------------|-------------|-----------|-----------|
| Clarithromycin | 0.94 | 0.86-0.98 | 0.89 |
| Ciprofloxacin | 0.86 | 0.66-0.94 | 0.74 |
| Amikacin | 0.81 | 0.56-0.92 | 0.65 |
| Clindamycin | 0.78 | 0.51-0.91 | 0.61 |
| Metronidazole | 0.77 | 0.49-0.91 | 0.76 |
| Meropenem | 0.76 | 0.47-0.90 | 0.58 |
| Teicoplanin | 0.74 | 0.42-0.89 | 0.63 |
| Piperacillin/ Tazobactam | 0.62 | 0.23-0.84 | 0.71 |
| Colistin | 0.58 | 0.17-0.82 | 0.69 |
| Vancomycin | 0.54 | 0.12-0.80 | 0.67 |
| Ceftriaxone | 0.46 | 0.01-0.75 | 0.35 |
| TOTAL ANTIMICROBIALS | 0.68 | 0.33-0.87 | 0.72 |

Conclusions/Learning Points: Use of a linear regression model to estimate DOTs/100BD

from DDDs/100BD could be a useful approach for PICUs where access to patient medical records is not feasible, although further validation of the model is needed.

PD101 / #778

MICROBIOLOGICAL CHARACTERIZATION OF CLINICAL ISOLATES IN PEDIATRIC APPENDICITIS DURING AN ANTIMICROBIAL STEWARDSHIP PROGRAM IN A TERTIARY HOSPITAL IN MADRID, SPAIN

E-Posters

POSTER DISCUSSION SESSION 05: ANTIMICROBIALS & ANTIBIOTIC STEWARDSHIP

Serena Villaverde¹, Patricia Brañas², José Manuel Caro³, Rocío Morante⁴, Esther Viedma², Jennifer Villa², María Angeles Orellana², Cristina Epalza¹

¹HOSPITAL 12 DE OCTUBRE, Paediatrics, MADRID, Spain, ²HOSPITAL 12 OCTUBRE OCTUBRE, Microbiology, Madrid, Spain, ³HOSPITAL 12 OCTUBRE OCTUBRE, Farmacology, Madrid, Spain, ⁴HOSPITAL 12 OCTUBRE, Pediatric Surgery, Madrid, Spain

Backgrounds: Appendicitis represents the most common abdominal surgical emergency in the pediatric age group and it is responsible of a high use of antibiotics. Antimicrobial stewardship programs (ASP) have shown effectiveness in reducing antimicrobial use in adults, but data on pediatric population are limited.

Methods: Retrospective study in a children tertiary hospital between 2016-2018 (only-ASP period) and 2019 (adding creation of protocol with computerized access: amoxicillin/clavulanate at diagnosis, ampicillin + gentamicin + metronidazole at induction only continued for complicated appendicitis). Bacterial epidemiology and susceptibility patterns were compared between the 2 periods, and microorganisms involved in post-operative complicated vs. uncomplicated appendicitis.

Results: From 1098 patients, 68.9% samples were processed, from which, 41,6% yielded a positive culture. Microorganisms isolated are shown in table 1. Antibiotic susceptibility rates were: 41,9% for ampicillin in *E. coli*; 91,0% and 88,2% for gentamicin, 91,0% and 97,1% for ciprofloxacin, in *E. coli* and *P. aeruginosa*, respectively; and 100% for metronidazole in *B. fragilis*. No multi-drug resistant microorganisms were found and only 4 ESBL-*E. coli* producers were isolated. Complications after surgery occurred in 22.2% of cases with positive culture. Fifty-nine episodes took place during only-ASP period ($p=0.039$). No statistical differences were observed in post-operative complicated vs. uncomplicated appendicitis related to patients or microorganisms variables.

Table 1. Microorganisms isolated in appendicitis in children between 2016 and 2019 in Hospital Universitario 12 Octubre, Madrid, Spain

| | All Positive samples (N=315) | ASP period (2016-2018) (N=241) | ASP+computerized access protocol (2019) (N=74) | P-value |
|--|------------------------------|--------------------------------|--|---------|
| Age (X± SD) | 8,9 ± 3,6 | 8,9 ± 3,7 | 8,8 ± 3,5 | 0,935 |
| Male sex | 196 (62,2) | 150 (62,2) | 46 (62,1) | 0,493 |
| Monomicrobial | 172 (54,6) | 128 (53,1) | 44 (59,5) | 0,171 |
| <i>Escherichia coli</i> | 235 (74,6) | 183 (75,9) | 52 (70,3) | 0,166 |
| <i>Pseudomonas aeruginosa</i> | 68 (21,6) | 49 (20,3) | 19 (25,7) | 0,167 |
| <i>Streptococcus milleri group*</i> | 81 (25,7) | 62 (25,7) | 19 (25,7) | 0,498 |
| <i>Bacteroides fragilis</i> | 29 (9,2) | 24 (24 (10) | 5 (6,8) | 0,212 |
| <i>Eikenella corrodens</i> | 10 (3,2) | 8 (3,3) | 2 (2,7) | 0,570 |
| <i>Klebsiella pneumoniae</i> | 8 (2,5) | 7 (2,9) | 1 (1,3) | 0,403 |
| <i>Enterococcus spp.</i> | 5 (1,6) | 4 (1,7) | 1 (1,3) | 0,665 |
| <i>Streptococcus spp.</i> | 7 (2,2) | 6 (2,5) | 1 (1,3) | 0,481 |
| <i>Haemophilus spp.</i> | 6 (1,9) | 5 (2,1) | 1 (1,3) | 0,569 |
| Other Enterobacterales** | 20 (6,3) | 14 (5,8) | 6 (8,1) | 0,319 |
| Other non-fermentative gram-negative bacilli | 2 (0,6) | 2 (0,8) | 0 (0) | 0,585 |
| Other anaerobes | 7 (2,2) | 5 (2,1) | 2 (2,7) | 0,518 |
| Other microorganisms | 2 (0,6) | 1 (0,4) | 1 (1,3) | 0,415 |

**S. milleri group*: *S. constellatus* (N= 42), *S. anginosus* (N=37), *S. intermedius* (N=2)

**Other Enterobacterales: *Klebsiella oxytoca* (N=5), *Citrobacter freundii* (N=4), *Proteus mirabilis* (N=1), *Enterobacter cloacae* (N=2), *Enterobacter aerogenes* (N=1), *Kluyvera ascorbata* (N=1), *Proteus vulgaris* (N=1), *Proteus penneri* (N=1), *Morganella morganii* (N=1), *Providencia rettgeri* (N=1)

Conclusions/Learning Points: We found low resistant antibiotic rates in appendicitis in children from 2016 to 2019. Bacteria and susceptibility patterns are similar in the two study periods and in post-operative complicated and not-complicated appendicitis. It suggests that complications are not so much related to the microorganisms involved or to a wrong empirical treatment received as probably to the control of the focus or the utilization of ASP protocols with computerized access for patient management.

ANTIBIOTIC PRESCRIBING AND PRACTICE IN A LARGE CHILDREN'S HOSPITAL IN LONDON (UK) 2017-2021: 5-YEAR TRENDS IN POINT PREVALENCE DATA

E-Posters

POSTER DISCUSSION SESSION 05: ANTIMICROBIALS & ANTIBIOTIC STEWARDSHIP

Kevin Meesters¹, Faye Chappell², Alicia Demirjian^{1,3,4}, Jonathan Cohen^{1,5}

¹Evelina London Children's Hospital, Department Of Paediatric Infectious Diseases And Immunology, London, United Kingdom, ²Evelina London Children's Hospital, Paediatric Pharmacy Department, London, United Kingdom, ³King's College London, Faculty Of Life Sciences And Medicine, London, United Kingdom, ⁴UK Health Security Agency, Healthcare-associated Infection & Antimicrobial Resistance Division, London, United Kingdom, ⁵Evelina London Children's Hospital, Paediatric Immunology & Infectious Diseases, London, United Kingdom

Backgrounds: We evaluated trends in inpatient antibiotic consumption, in line with the World Health Organization (WHO) Adapt AWaRe goals for 2023, in a large UK tertiary children's hospital, and noted the quality of antimicrobial prescriptions.

Methods: Point prevalence surveys (PPS) were conducted by a paediatric infectious diseases pharmacist, every four months between 2017 and 2021. Antibiotics were classified per agent and per WHO AWaRe category, and trends over time were analyzed. Prescriptions were scored on whether indication and duration were documented and whether the prescription accorded with institutional guidelines.

Results: In the first measurements of usage in 2017, 41-43.5% of all inpatients received at least one antibiotic, which decreased to 26.8% in 2021, during the COVID-19 pandemic. The proportion of prescriptions per WHO AWaRe group were most commonly Watch (29.7-46.5%; this includes co-amoxiclav as per UK adaptation), followed by Access (6.2-29.6%) and Reserve (0-3.0%). The most commonly prescribed antibiotics were co-amoxiclav and cephalosporins overall, gentamicin in Access and co-amoxiclav and cephalosporins in Watch. As medical prophylaxis with azithromycin is commonly administered three days weekly and not fully captured in the PPS, the number of macrolides prescriptions might be underestimated. 1053 prescriptions were assessed for quality. There was an improvement over time in the quality of prescribing especially with respect to documentation of duration.

Conclusions/Learning Points: While the total proportion of inpatients prescribed antibiotics may have declined between 2017-2021, the proportion of Access prescriptions (6.2-29.6%) is well below the WHO Adapt AWaRe target of 60%. Future stewardship activities should focus on frequently prescribed antibiotics such as co-amoxiclav, cephalosporins and azithromycin. There is also room for further improvement in documentation especially of treatment duration.

COMPARISON OF IMMUNOGENICITY AND SEROEFFICACY BETWEEN TEN- AND THIRTEEN-VALENT PNEUMOCOCCAL CONJUGATE VACCINES – A SYSTEMATIC REVIEW AND NETWORK META-ANALYSIS

E-Posters

POSTER DISCUSSION SESSION 06: VACCINE I

Shuo Feng¹, Julian Higgins², Maria Knoll³, Julie Mclellan⁴, Kim Muholland⁵, Nicola Pidduck⁴, Andrew Pollard⁶, Beth Temple⁷, Merryn Voysey⁶

¹University of Oxford, Department Of Paediatrics, Oxford, United Kingdom, ²University of Bristol, Bristol Medical School, Bristol, United Kingdom, ³Johns Hopkins University, Bloomberg School Of Public Health, Baltimore, United States of America, ⁴University of Oxford, Nuffield Department Of Primary Care And Health Science, Oxford, United Kingdom, ⁵London School of Hygiene and Tropical Medicine, N/a, London, United Kingdom, ⁶University of Oxford, Paediatriccs, Oxford, United Kingdom, ⁷Menzies, School Of Health Research, Darwin, Australia

Backgrounds: Evidence is limited regarding the comparative serotype-specific immunogenicity and efficacy of the two most widely used pneumococcal conjugate vaccines (PCV), PCV13 and PCV10.

Methods: We conducted a systematic-review of studies in which the immunogenicity of PCVs was directly compared in head-to-head randomised trials. We combined data in a network meta-analysis incorporating both direct pair-wise comparisons and indirect comparisons to increase overall statistical precision for the main comparison of interest (PCV10 vs PCV13). The difference in anti-serotype-specific polysaccharide IgG responses, as measured by the geometric mean ratio (GMR) comparing PCV13 vs PCV10, was calculated for each serotype. Seroinfection was defined as a rise in antibody between the primary vaccination series and the booster dose and considered evidence of likely sub-clinical infection. Seroefficacy was estimated as the relative rate of seroinfection between PCV13 and PCV10.

Results: 27 trials were included in the network meta-analysis. 6 studies directly compared PCV10 and PCV13, 6 compared PCV7 and PCV10, and 15 compared PCV7 with PCV13. Individual participant level data were available from 21 (77.8%) trials. Immunogenicity at 1 month after the primary vaccination series was higher for PCV13 for 6 serotypes (1, 4, 6B, 7F, 9V, 23F), with anti-serotype GMRs ranging from 1.11 to 2.39. In contrast, anti-serotype 18C IgG was higher in after PCV10. Similarly, seroefficacy analysis indicated higher efficacy using PCV13 for 6 serotypes (4, 6B, 7F, 9V, 18C and 23F), with point estimates for the relative risk ranging from 0.24 to 0.54.

Conclusions/Learning Points: Differences in serotype-specific immunogenicity of PCVs are associated with corresponding differences in the rate of seroefficacy.

PD104 / #384

COMPARING THE PUBLIC HEALTH IMPACT OF SWITCHING TO PEDIATRIC 13-VALENT PNEUMOCOCCAL CONJUGATE VACCINE IN THE NEAR-TERM AND HIGHER-VALENT PNEUMOCOCCAL CONJUGATE VACCINES IN THE LONG-TERM IN THE NETHERLANDS

E-Posters

POSTER DISCUSSION SESSION 06: VACCINE I

Vishalini Sundaram¹, Johnna Perdrizet¹, Matt Wasserman¹, Mickey Wilson², Cheryl Mcdade², Anna Trisia Beby-Heijtel³, Angela Waterval-Overbeek³

¹Pfizer Inc., Patient Health Impact, Vaccines, New York, United States of America, ²RTI Health Solutions, Health Economics And Outcomes Research, Research Triangle Park, United States of America, ³Pfizer BV, Medical Affairs, Capelle aan den IJssel, Netherlands

Backgrounds: In the Netherlands, the 10-valent pneumococcal conjugate vaccine (PCV10) has been on the infant national immunization program (NIP) since 2011. After ten years of implementation, PCV10 only covers 2% of remaining invasive pneumococcal disease (IPD) in children <5 years. Whereas the 13-valent (PCV13) covers 27% of remaining IPD and would provide broader coverage. Higher-valent PCVs, a 15-valent (PCV15) and a 20-valent (PCV20), may soon be available in 2024 and cover more disease burden. The objective is to determine the public health impact of switching the PCV10 NIP to (1) PCV13 in the near-term (2021-2023) and (2) PCV15 or PCV20 in the long-term (2024-2028).

Methods: A decision-analytic model was adapted to estimate IPD, hospitalized and non-hospitalized pneumonia, otitis media (OM) cases and deaths. The model utilized historical age-stratified real-world data to estimate future disease. IPD incidence reductions for newly covered serotypes were projected for PCV13, PCV15, and PCV20 by using the annual percent reductions in PCV13-10 type IPD from a systematic review. OM and pneumonia incidence are assumed to vary proportionately with IPD.

Results: Switching to PCV13 in 2021 is estimated to prevent 701 IPD, 3,699 OM, 10,666 non-hospitalized pneumonia, and 1,444 hospitalized pneumonia cases, and 209 deaths over 3 years (Figure 1). Compared with switching to PCV15 in 2024, switching to PCV13 in 2021 and PCV20 in 2024 is estimated to prevent a total of 26,542 cases and 895 deaths over 8 years (Figure 1).

| Figure 1: Results from Public Health Impact Analysis in the Overall Population | Analysis 1: PCV13 vs PCV10 (2021-2023) | | | Analysis 2: PCV15 and PCV20 vs PCV13 & PCV20 (2021 - 2028) | | | |
|---|--|---------|----------------|--|----------------|----------------|----------------|
| | Overall | | Incremental | Overall | | | Incremental |
| PCV on NIP in 2021 - 2023 | PCV13 | PCV10 | (PCV13-PCV10) | PCV10 | PCV10 | PCV13 | PCV13 & PCV20 |
| PCV on NIP in 2024-2028 | - | - | - | PCV15 | PCV20 | PCV20 | -PCV10 & PCV15 |
| Outcome | | | | | | | |
| Total disease cases | | | -16,511 | 613,129 | 603,098 | 586,586 | -26,542 |
| Bacteremia | 5,087 | 5,543 | -457 | 15,973 | 14,732 | 14,276 | -1,697 |
| Meningitis | 2,720 | 2,965 | -244 | 8,542 | 7,879 | 7,635 | -907 |
| Otitis media | 53,701 | 57,400 | -3,699 | 154,829 | 151,449 | 147,749 | -7,080 |
| Non-hospitalized pneumonia | 100,155 | 110,821 | -10,666 | 377,601 | 377,022 | 366,356 | -11,245 |
| Hospitalized pneumonia | 17,907 | 19,351 | -1,444 | 56,184 | 52,016 | 50,571 | -5,613 |
| Deaths | | | | | | | |
| Total deaths | | | -209 | 9,753 | 9,067 | 8,858 | -895 |
| IPD | 1,075 | 1,150 | -75 | 3,351 | 3,109 | 3,034 | -317 |
| Hospitalized pneumonia | 2,056 | 2,189 | -133 | 6,402 | 5,958 | 5,824 | -578 |
| Abbreviations: OM = otitis media; IPD = invasive pneumococcal disease; PCV = pneumococcal conjugate vaccine; NIP = National Immunization Program | | | | | | | |

Conclusions/Learning Points: Compared to maintaining PCV10, switching to PCV13 can reduce disease burden in the near-term. However, switching to PCV13 in 2021 and PCV20 in 2024 is estimated to provide the greatest public health impact in the near- and long-term by protecting against serotypes that are not currently covered.

EPIDEMIOLOGY AND MICROBIOLOGY OF BACTERIAL ACUTE OTITIS MEDIA WITH OTORRHEA IN THE ERA OF PNEUMOCOCCAL CONJUGATE VACCINES IN A TERTIARY HOSPITAL IN ATHENS, GREECE

E-Posters

POSTER DISCUSSION SESSION 06: VACCINE I

Irene Tzovara¹, Anastasios Doudoulakakis², George Kalogeras², Aikaterini Tsiligianni², Charilaos Dellis³, Irene Paraskakis², Evangelia Lebessi², Maria Tsolia⁴

¹"Aghia Sophia" Children's Hospital, 1st Department Of Pediatrics, National And Kapodistrian University Of Athens, Athens, Greece, ²"P. & A. Kyriakou" Children's Hospital, Department Of Microbiology, Athens, Greece, ³National and Kapodistrian University of Athens, 1st Department Of Pediatrics, Infectious Diseases And Chemotherapy Research Laboratory, Athens, Greece, ⁴"P. & A. Kyriakou" Children's Hospital, 2nd Department Of Pediatrics, National And Kapodistrian University Of Athens, Athens, Greece

Backgrounds: Acute otitis media (AOM) can be complicated by otorrhea (AOMO). In 2011, 13-valent Pneumococcal Conjugate Vaccine (PCV13) replaced the 7-valent (PCV7). The aim of this study was to evaluate the effect of pneumococcal immunization, on the epidemiology of AOMO in a tertiary children's hospital in Athens, Greece.

Methods: Middle ear fluid cultures from 2283 children with AOMO examined in "P.&A. Kyriakou" Children's Hospital were collected from 2007-2019. In total 2598 otopathogens were isolated and tested for antimicrobial susceptibility and 228 *S.pneumoniae* isolates were available for serotyping during years 2013-2019. Data were compared between the PCV7- (2007-2011) and PCV13-period (2012-2019).

Results: The most common otopathogens over the 12-year period were *S.pyogenes* (35.4%), *H.influenzae* (34%), and *S.pneumoniae* (26.3%). The frequency of all-cause AOMO, *S.pneumoniae* and *H.influenzae* AOMO decreased by 14%, 31% and 22%, respectively (OR 0.86, 0.69 and 0.78, $p<0.001$). Susceptibility of *S.pneumoniae* to amoxicillin and clindamycin was significantly reduced from 95.6% to 88.9% ($p=0.003$) and 83.9% to 77.2% ($p=0.039$) respectively, while susceptibility to erythromycin remained stable (65.8% vs 66.3%). Resistance of *H.influenzae* to ampicillin increased from 6.3% to 13.9%, $p<0.001$. A significant reduction of cotrimoxazole-resistant *S.pneumoniae* from 31.2% to 22.4% ($p=0.012$), and clindamycin-resistant and erythromycin-resistant *S.pyogenes* from 17.4% to 9.8% and 21.4% to 10.8% respectively ($p\leq 0.001$), was observed. Overall, 34 *S.pneumoniae* serotypes were found, among which serotype 3 (28.95%) and 19A (12.72%) prevailed, followed by 19F (7.02%).

Conclusions/Learning Points: After the shift to PCV13, the frequency of AOMO significantly decreased. The most common causes are now *S.pyogenes* and *H.influenzae*. However, *S. pneumoniae* remains an important otopathogen with significant antimicrobial resistance. Serotype 3 was mostly detected, followed by 19A. Universal vaccination alone is insufficient to control antibiotic resistance and should be accompanied by rational antibiotic use.

PHASE 3 STUDY OF SAFETY, TOLERABILITY AND IMMUNOGENICITY OF V114 PNEUMOCOCCAL VACCINE COMPARED WITH PCV13 IN A 2+1 REGIMEN IN HEALTHY INFANTS (PNEU-PED-EU-2)

E-Posters

POSTER DISCUSSION SESSION 06: VACCINE I

Thomas Benfield¹, Mika Rämetsä², Piero Valentini³, Ilkka Seppä², Luwy Musey⁴, Kara Bickham⁵, Swati Mercer⁶, Clay Churchill⁷, Jun Park⁸, Robert Lupinacci⁸, Richard Mcfettridge⁹, Frederick Wittke¹⁰, Janusz Kaminski¹¹

¹University of Copenhagen, Department Of Clinical Medicine, Hvidovre, Denmark, ²Tampere University, Vaccine Research Center, Tampere, Finland, ³Fondazione Policlinico Universitario Agostino Gemelli IRCCS, Department Of Woman And Child Health And Public Health, Rome, Italy, ⁴Merck & Co., Inc., Vaccine, Clinical Research, Kenilworth, United States of America, ⁵Merck & Co., Inc., Global Clinical Development, Kenilworth, United States of America, ⁶Merck & Co., Inc., Clinical Sciences And Study Management (cssm), Kenilworth, United States of America, ⁷Merck & Co., Inc., Infectious Disease/vaccine, Kenilworth, United States of America, ⁸Merck & Co., Inc., Biostatistics And Research Decision Sciences, Kenilworth, United States of America, ⁹Merck & Co., Inc., Mrl, Kenilworth, United States of America, ¹⁰MSD, European Clinical Development Gcd Vaccines - Mrl, Lucerne, Switzerland, ¹¹MSD, European Clinical Development, London, United Kingdom

Backgrounds: Despite the availability of pneumococcal conjugate vaccines (PCVs) in children, significant burden of pneumococcal disease caused by non-vaccine serotypes remains a concern. V114 is a 15-valent PCV containing the 13 serotypes in 13-valent PCV (PCV13) plus two additional serotypes (22F and 33F). This study evaluated safety and immunogenicity of a 2+1 regimen of V114 compared with PCV13 in healthy infants, and concomitant administration of V114 or PCV13 with diphtheria, tetanus, pertussis (DTaP)/inactivated poliovirus (IPV)/Haemophilus influenzae type b (Hib)/hepatitis B (HepB) vaccine administered at 3, 5 and 12 months of age.

Methods: Proportions of patients with adverse events (AEs) were reported from Days 1–14 post-vaccination. Serotype-specific anti-pneumococcal polysaccharide immunoglobulin G (IgG) and opsonophagocytic activity were measured at 30 days post-dose 2, pre-dose 3 and 30 days post-dose 3 (PD3). Antigen-specific response rates to DTaP/IPV/Hib/Hep B vaccine were also measured.

Results: Overall, 1191 healthy infants 70–111 days of age were randomised 1:1 to V114 (n=595) or PCV13 (n=596). Proportions of participants with solicited AEs and serious AEs were comparable between vaccination groups. V114 met non-inferiority criteria for all 13 shared serotypes and superiority criteria for serotypes 22F and 33F, as assessed by IgG response rates (Table) and geometric mean concentrations at 30 days PD3. Immune responses elicited by DTaP/IPV/Hib/Hep B vaccine administered concomitantly with V114 were non-inferior to those following concomitant administration with PCV13.

Conclusions/Learning Points: In healthy infants, V114 was well tolerated, with a safety profile generally comparable to PCV13. Compared with PCV13, V114 provided non-inferior immune responses to the 13

shared serotypes and superior immune responses to unique serotypes 22F and

Table. Proportions of participants with IgG ≥ 0.35 $\mu\text{g/ml}$ at 30 days post-dose 3

| Pneumococcal serotype | V114 (N=595) | PCV13 (N=596) | Percentage point difference (V114-PCV13) | |
|---|------------------------------------|------------------------------------|--|----------------------------------|
| | Observed response percentage (m/n) | Observed response percentage (m/n) | Estimate (95% CI) ^{a,b} | p-value ^{a,b} (1-sided) |
| 13 shared serotypes (non-inferiority) | | | | |
| 1 | 96.9 (495/511) | 99.1 (535/540) | -2.2 (-4.2, -0.6) | <0.001 |
| 3 | 92.8 (474/511) | 82.2 (444/540) | 10.5 (6.6, 14.5) | <0.001 |
| 4 | 96.7 (494/511) | 98.3 (529/538) | -1.7 (-3.8, 0.2) | <0.001 |
| 5 | 99.4 (508/511) | 99.6 (537/539) | -0.2 (-1.4, 0.8) | <0.001 |
| 6A | 99.2 (507/511) | 99.4 (535/538) | -0.2 (-1.5, 0.9) | <0.001 |
| 6B | 99.2 (507/511) | 99.1 (533/538) | 0.1 (-1.2, 1.5) | <0.001 |
| 7F | 100.0 (511/511) | 99.6 (538/540) | 0.4 (-0.4, 1.3) | <0.001 |
| 9V | 99.8 (509/510) | 99.6 (538/540) | 0.2 (-0.8, 1.2) | <0.001 |
| 14 | 99.2 (507/511) | 99.6 (536/538) | -0.4 (-1.7, 0.7) | <0.001 |
| 18C | 99.8 (510/511) | 99.4 (537/540) | 0.4 (-0.6, 1.4) | <0.001 |
| 19A | 99.6 (509/511) | 99.8 (537/538) | -0.2 (-1.2, 0.7) | <0.001 |
| 19F | 99.8 (510/511) | 99.6 (537/539) | 0.2 (-0.8, 1.2) | <0.001 |
| 23F | 97.8 (497/508) | 97.0 (519/535) | 0.8 (-1.2, 2.9) | <0.001 |
| Two serotypes unique to V114 (superiority) | | | | |
| 22F | 99.4 (508/511) | 5.4 (29/535) | 94.0 (91.6, 95.7) | <0.001 |
| 33F | 99.2 (507/511) | 2.1 (11/524) | 97.1 (95.3, 98.2) | <0.001 |

Per protocol, dose 3 was administered at ~12 months of age. N = number of participants randomised and vaccinated; n = number of participants contributing to the analysis; m = number of participants with the indicated response.

^aEstimated difference, CI and p-value are based on the Miettinen & Nurminen method.

^bFor the 13 shared serotypes, the statistical criterion for non-inferiority requires the lower bound of the 2-sided 95% CI for the difference in response rates (V114-PCV13) to be greater than -10.0. For the two serotypes unique to V114, the statistical criterion for superiority of V114 to PCV13 requires the lower bound of the 2-sided 95% CI for the difference in response rates (V114-PCV13) to be greater than 10.0.

CI, confidence interval; IgG, immunoglobulin G; PCV13, 13-valent pneumococcal conjugate vaccine; V114, 15-valent pneumococcal conjugate vaccine.

PD107 / #461

INVASIVE MENINGOCOCCAL DISEASE EPIDEMIOLOGY AND VACCINATION STRATEGIES IN FOUR SOUTHERN EUROPEAN COUNTRIES: A REVIEW OF THE AVAILABLE DATA

E-Posters

POSTER DISCUSSION SESSION 06: VACCINE I

Irini Zografaki¹, Marios Detsis¹, Ana Maia², Maria Del Amo³, Raffaella Iantomasi⁴, Eva Montuori⁴, Cristina Mendez³

¹Pfizer Hellas, Vaccines Department, Athens, Greece, ²Pfizer Portugal, Vaccines Department, Porto Salvo, Portugal, ³Pfizer Spain, Vaccines Department, Madrid, Spain, ⁴Pfizer Italy, Vaccines Department, Rome, Italy

Backgrounds: Invasive meningococcal disease (IMD) is a rare yet severe disease with high mortality. Conjugate vaccines against serogroups A, C, W and Y and two protein-based vaccines against serogroup B are currently available in the EU. Aim of this study is to describe time trends in overall incidence and serogroup distribution, as well as impact of immunization in four Southern European Countries.

Methods: We reviewed surveillance reports from national reference laboratories and immunization programs for the period 1999-2019 to retrieve IMD incidence and serogroup distribution through time and introduction of meningococcal vaccines in Italy, Portugal, Greece and Spain.

Results: Evolution of IMD incidence and serogroup distribution as well as dates of introduction of meningococcal vaccines are presented in Figure 1. Incidence of IMD in Portugal, Greece, and Spain has been declining, while Italy shows relatively stable trends over the examined period. The most affected age groups are infants and toddlers followed by adolescents and young adults.

A. Italy

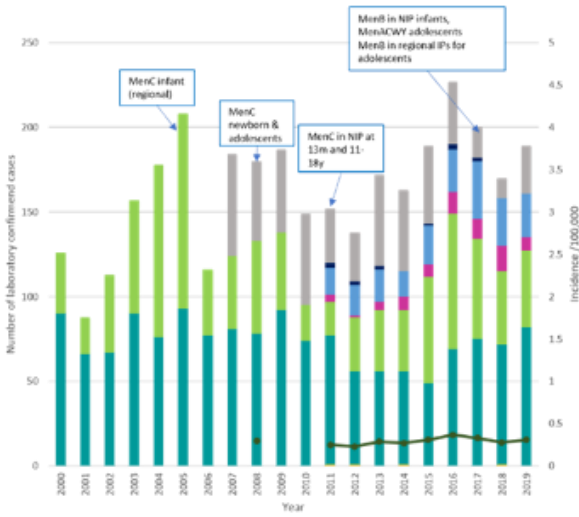

B. Portugal

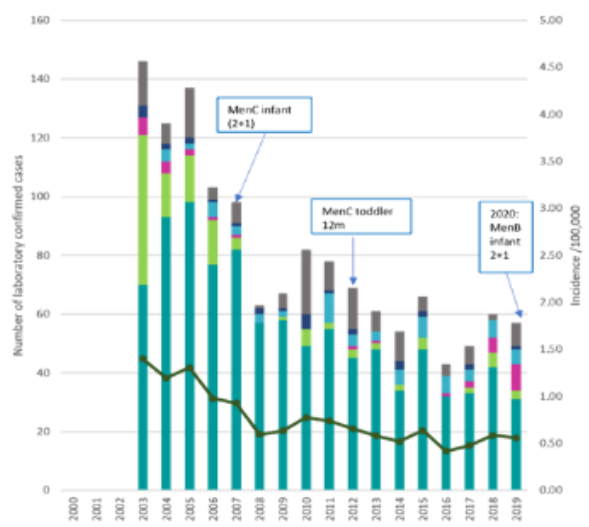

C. Greece

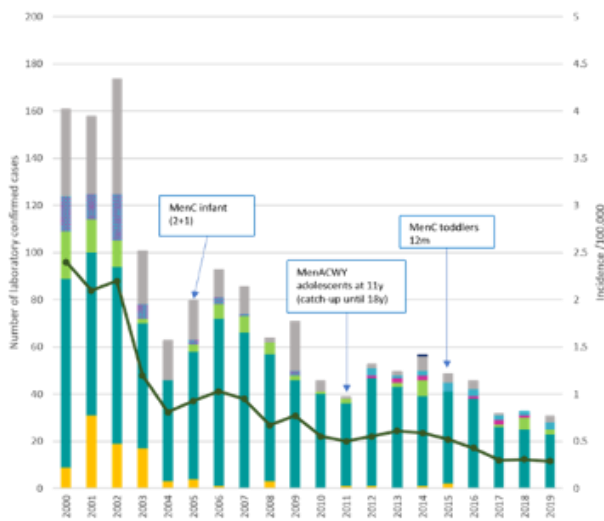

D. Spain

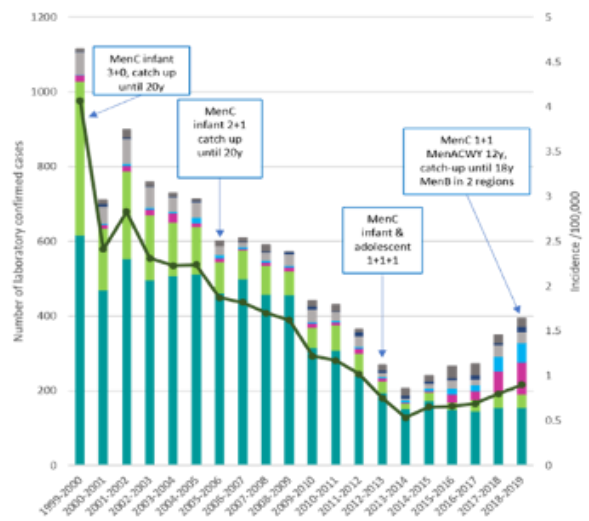

■ Serogroup B ■ Serogroup A ■ Serogroup C ■ Serogroup W&Y ■ Serogroup W
■ Serogroup Y ■ Non groupable ■ Other ■ Unknown — Incidence per 100,000

Conclusions/Learning Points: Throughout the examined period, introduction of MenC conjugate vaccines has shown significant impact on the disease in Portugal, Spain and Greece. Italy, the last to introduce MenC vaccination, showed a delayed drop in serogroup C cases. Recent increases in serogroups W and Y have been observed in Spain, Italy and Portugal. In Greece, where a proactive immunization strategy has been in place since 2011 (MenACWY in adolescence), cases of serogroups W and Y have remained low. Despite the predominance of serogroup B, MenB vaccines are only recently being introduced in national (Italy 2017, Portugal 2020) and regional (Spain 2019) immunization programmes. Given the unpredictable epidemiology of IMD, prevention strategies targeting all risk groups and serogroups, including serogroup B, are imperative for efficient control of the disease.

COST IMPLICATION OF INTRODUCING A FULLY LIQUID READY-TO-USE PEDIATRIC HEXAVALENT VACCINE IN NORWAY

E-Posters

POSTER DISCUSSION SESSION 06: VACCINE I

John Lang¹, Kristin Kittelsen², Ugne Sabale³, Tomas Marcek⁴, Edith Langevin⁵, Tanaz Petigara⁶
¹Merck & Co., Inc., Bards, West Point, United States of America, ²MSD Norge AS, Market Access, Drammen, Norway, ³MSD Sweden, Core, Stockholm, Sweden, ⁴MCM Vaccine B.V., Mcm Vaccine, Leiden, Netherlands, ⁵Sanofi Pasteur, Market Access, Lyon, France, ⁶Merck & Co., Inc., Center For Observational And Real-world Evidence, Philadelphia, United States of America

Backgrounds: Hexavalent vaccines (HV) contain antigens that help protect against diseases caused by six infectious agents in a single injection. A HV containing powder and suspension for reconstitution, protecting against diphtheria, tetanus, pertussis, poliomyelitis, hepatitis B, and Haemophilus influenzae type b diseases (HV-R; INFANRIX® hexa; DTaP3-HepB-IPV/Hib; GlaxoSmithKline Biologicals s.a., Rixensart, Belgium) is currently available in Norway. A fully-liquid ready-to-use HV, protecting against the same six infectious agents, but not requiring reconstitution (HV-NR; VAXELIS™; DTaP5-IPV-Hib-HepB; MCM Vaccine B.V., Leiden, The Netherlands) has been licensed in the European Union and United States. The objective of this study is to assess cost implications of using HV-NR versus HV-R in the national immunization program of Norway during the first year of life.

Methods: A previously published budget impact model (BIM), developed from a healthcare provider (HCP) perspective under the assumption of clinical equivalence and price parity between HV-R and HV-NR, was applied to Norway over a 5-year time-horizon. We compare two scenarios for HV use at 3, 5, and 12 months: a baseline scenario with exclusive HV-R use (all years: HV-R – 100%) and an alternative scenario with exclusive HV-NR use (all years: HV-NR – 100%). Undiscounted costs are presented in 2021 currency.

Results: The use of HV-NR versus HV-R resulted in potential savings of Norwegian Krone (NOK) 7,852,720 (2,062,442 – 15,610,424; €769,567 [202,119 – 1,529,822]) over a 5-year time-horizon, resulting primarily from HCP costs (46%), vaccine acquisition costs (32%; 28% and 4% attributable to vaccine wastage from leakage and heat failure), and non-needle-stick injury error costs (21%).

Cost savings per eligible infant per year for HV-NR compared with HV-R in the Norwegian national immunization program

| Outcome ^{a,b} | Cost, time, needlestick injury, and vaccination error savings of HV-NR vs HV-R | | |
|---|--|-------------------------|-------------|
| | Norwegian Krone (NOK) | Euro (€) | Percent (%) |
| Total cost savings per infant per year | 32.02 (8.41 – 63.64) | 3.14 (0.82 – 6.24) | 100.00 |
| Vaccine acquisition cost savings | 10.33 (2.49 – 20.89) | 1.01 (0.24 – 2.05) | 32.26 |
| Vaccine waste from leakage | 8.98 | 0.87 | 28.04 |
| Vaccine waste from heat failure | 1.35 | 0.13 | 4.22 |
| Healthcare provider savings | | | |
| Time per infant | | 1.83 minutes | |
| Cost | 14.84 (2.15 – 34.12) | 1.38 (0.21 – 3.34) | 46.36 |
| Needle-stick injury savings | | | |
| Number of events | | 0.000041 | |
| Cost | 0.013 (0.002 – 0.033) | 0.001 (0.0001 – 0.0032) | 0.04 |
| Non-needle-stick injury error | | | |
| Number of events | | 0.029 | |
| Cost | 6.83 (1.70 – 13.42) | 0.67 (0.17 – 1.32) | 21.33 |

^a Results are reported per eligible infant per year. The number of eligible children in year 1 is 51,570; growth rate and vaccine coverage rate (i.e., for full 3-dose regimen) are assumed to be -2.5% and 97%, respectively. Ranges are 95% intervals computed from the probability sensitivity analysis.

^b Costs are reported in 2021 currency. Conversion to Euros is calculated using year to date average 2021 exchange rate (0.0980 € = 1 NOK).

Conclusions/Learning Points: Application of an existing BIM to Norway demonstrates potential cost savings from introducing a fully-liquid ready-to-use pediatric hexavalent vaccine of up to NOK 7.9 million over a 5-year time-horizon.

PD109 / #1834

COMPARISON OF MATERNAL AND CORD MEASLES ANTIBODY TITRES ACROSS FIVE COUNTRIES

E-Posters

POSTER DISCUSSION SESSION 06: VACCINE I

Karen Tiley¹, Hinke Ten Hulscher-Van Overbeek², Patrick Ansah³, Rob Van Binnendijk², Ed Clarke⁴, Stephen Cose⁵, Duc Anh Dang⁶, Ha Thi Thu Hoang⁶, Beth Holder⁷, Olubukola Idoko⁴, Beate Kampmann⁸, Fiona Van Der Klis², Abdul Kazi⁹, Elke Leuridan¹⁰, Kirsten Maertens¹⁰, Herberth Maldonado¹¹, Saad Omer¹², Marcela Pasetti¹³, Nynke Rots², Nasamon Wanlapakorn¹⁴, Merryn Voysey¹
¹University of Oxford, Oxford Vaccine Group, Oxford, United Kingdom, ²National Institute for Public Health and the Environment, RIVM, Bilthoven, Netherlands, ³Navrongo Health Research Centre, Navrongo, Navrongo, Ghana, ⁴London School of Hygiene and Tropical Medicine, MRC Unit, The Gambia, London, United Kingdom, ⁵London School of Hygiene and Tropical Medicine, MRC Uganda Virus Research Institute, London, United Kingdom, ⁶National Institute for Hygiene and Tropical Medicine, Hanoi, Viet Nam, ⁷Imperial College, Institute of Reproductive Biology, London, United Kingdom, ⁸London School of Hygiene and Tropical Medicine, Vaccine Centre, London, United Kingdom, ⁹The Aga Khan University, Department of Pediatrics and Child Health, Karachi, Pakistan, ¹⁰University of Antwerp, Centre for the Evaluation of Vaccination, Vaccine & Infectious Diseases Institute, Antwerp, Belgium, ¹¹Universidad del Valle de Guatemala, Centro de Estudios en Salud, Guatemala City, Guatemala, ¹²Yale School of Public Health, Yale Institute for Global Health, New Haven, United States of America, ¹³University of Maryland, School of Medicine, Baltimore, United States of America, ¹⁴Chulalongkorn University, Department of Pediatrics, Bangkok, Thailand

Backgrounds: An infant's starting (cord) measles maternal antibody titre at delivery is dependent on both the mother's antibody titre and the efficiency of antibody transfer across the placenta. Here we compare maternal and cord samples from different country settings in Africa, South East Asia and Europe and explore influencing factors.

Methods:: Stored blood samples collected as part of mother/infant studies were processed for anti-measles IgG quantification using a multiplex immunoassay at a central laboratory.

Results: Maternal geometric mean antibody titres (GMT) were highest in Mali and Vietnam (0.9 and 1.0 respectively IU/ml) compared to 0.7, 0.5 and 0.4 IU/ml in Thailand, UK and Netherlands respectively (difference between means $p < 0.01$) but cord blood GMTs were more similar across all countries (0.9-1.3 IU/ml, $p = 0.42$) (Figure).

Mother and cord measles IgG by country

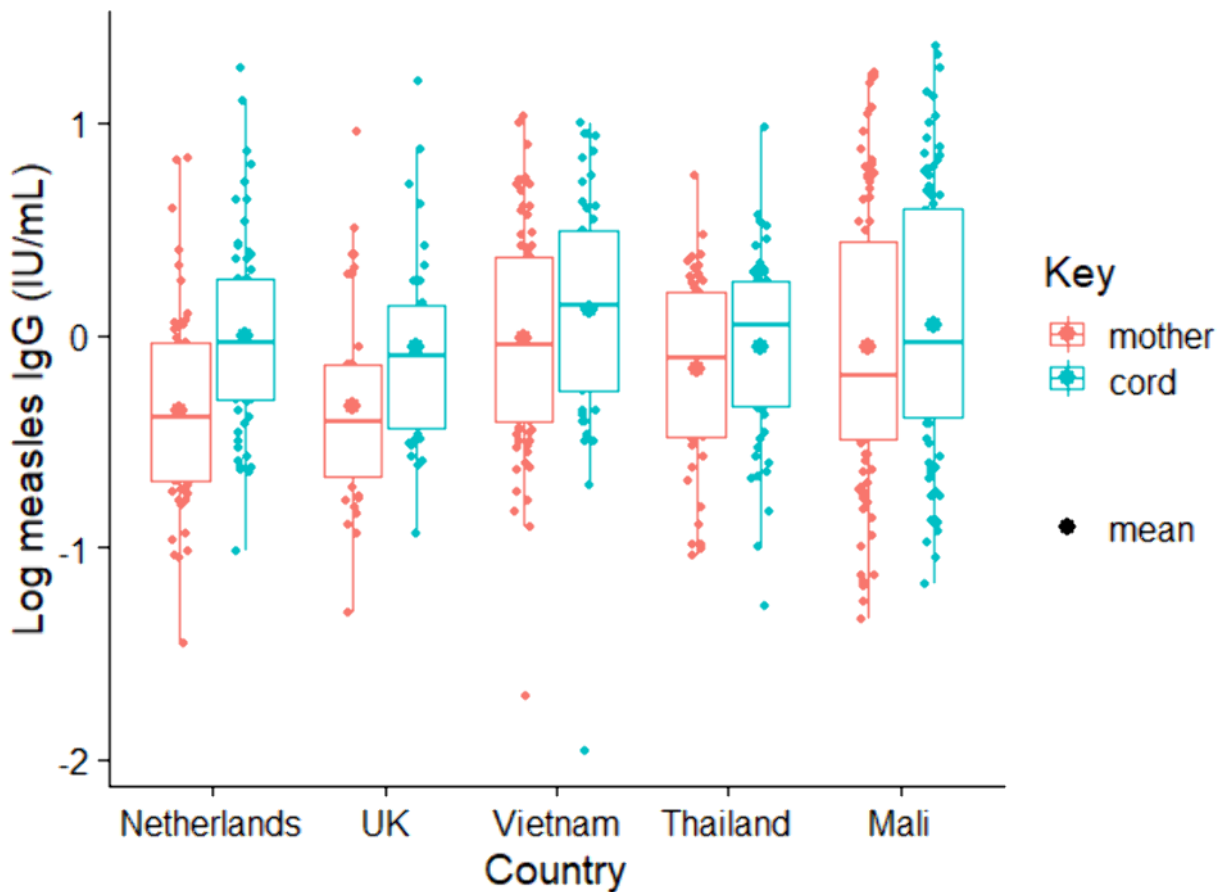

The ratio of cord vs maternal antibody titres was highest in high income countries (median (range)) 2.3 (1.1 – 4.6) Netherlands, 2.0 (0.9 – 3.3) UK, and lowest in low income countries 1.3 (0.3 – 12.2) Mali, 1.3 (0.5 – 5.2) Thailand, 1.5 (0.3 – 5.2) Vietnam. In multivariate regression country and vaccine coverage (for mother's year of birth; higher coverage, higher ratio), were significant predictors of cord/maternal ratio ($p < 0.05$).

Conclusions/Learning Points: Despite variation in maternal antibody titres, cord antibody titres were similar, and consistently higher than maternal titres implying active transfer. Whether lower maternal antibody titres (related to higher vaccine coverage) result in higher cord/maternal ratios in different country settings, e.g. up to a maximum level of active transplacental transport, or whether this ratio depends more on country-level factors is important to understand. Antibody decay from this starting point will determine the age infants become susceptible to infection and therefore the optimum timing for first measles vaccination.

PD110 / #1899

REACTOGENICITY OF SECOND TRIMESTER MATERNAL TETANUS, DIPHTHERIA AND ACELLULAR PERTUSSIS VACCINATION IN THE NETHERLANDS: PRELIMINARY RESULTS

E-Posters

POSTER DISCUSSION SESSION 06: VACCINE I

Maarten Immink¹, Jeanet Kemmeren¹, Lisa Broeders², Mireille Bekker³, Hester De Melker¹, Elisabeth Sanders¹, Nicoline Van Der Maas¹

¹National Institute for Public Health and the Environment, Centre For Infectious Disease Control, Bilthoven, Netherlands, ²Perined, The Dutch Perinatal Registry, Utrecht, Netherlands, ³Wilhelmina Children's Hospital, University Medical Center Utrecht, Department Of Obstetrics, Utrecht, Netherlands

Backgrounds: Since December 2019, a maternal tetanus, diphtheria, and acellular pertussis (Tdap) vaccine is offered to all pregnant women in the second trimester of pregnancy in the Netherlands. Implementations of new vaccinations require safety monitoring, especially when targeting vulnerable populations. We assessed the reactogenicity of the maternal Tdap-vaccination between 20 and 24 weeks of gestation.

Methods:: After receiving a Tdap-vaccination between 20 and 24w of gestation, pregnant women completed a questionnaire on local reactions and systemic AEs occurring within one week after vaccination, and for the same systemic events in the week before vaccination. We used binary generalized mixed statistical methods to identify increased AEs after vaccination.

Results: 721 of 974 (74%) vaccinated pregnant women completed the questionnaire. Pain at the injection site (62.3%) was the most reported local reaction, but manifested mild- (49.6%) or moderately (38.4%) in most cases in relation to severe reactions (12.0%). Significantly increased AEs in the week after vaccination compared to the week before vaccination were stiffness in muscles or joints (OR=33.1, 95%CI=11.2-98.2), rash (OR=8.0, 95%CI=1.3-50.6), fatigue (OR=4.0, 95%CI=2.0-8.0), headache (OR=3.7, 95%CI=1.9-7.0), and nausea (OR=3.7, 95%CI=1.3-10.8) (Table 1).

Conclusions/Learning Points: Second trimester maternal Tdap-vaccination is considered well-tolerated and comparable with studies assessing reactogenicity in men and non-pregnant women. Antenatal care providers should inform pregnant women that, along with the vaccine's high effectiveness and established safety profile, they should expect some stiffness in muscles or joints, rash, fatigue, headache or nausea after maternal Tdap-vaccination.

PD111 / #1817

A RANDOMISED TRIAL ASSESSING THE IMMUNOGENICTY AND REACTOGENICITY OF TWO HEXAVALENT INFANT VACCINES CONCOMITANTLY ADMINISTERED WITH GROUP B MENINGOCOCCAL VACCINE

E-Posters

POSTER DISCUSSION SESSION 06: VACCINE I

Matthew Rajan¹, Natalie Marchevsky¹, Gemma Sinclair¹, Katie O'Brien¹, Kimberley Jefferies¹, Nelly Owino¹, Bassam Hallis², David Goldblatt³, Parvinder. K Aley¹, Xinxue Liu¹, Matthew. D Snape^{1,4}
¹University of Oxford, Oxford Vaccine Group, Department Of Paediatrics, Oxford, United Kingdom, ²UK Health Security Agency, Department Of Health And Social Care, Salisbury, United Kingdom, ³University College London, Great Ormond Street Institute Of Child Health Biomedical Research Centre, London, United Kingdom, ⁴Oxford University Hospitals NHS Foundation Trust, National Institute For Health Research Oxford Biomedical Research Centre, Oxford, United Kingdom

Backgrounds: Four hexavalent (DTaP-IPV-Hib-HepB) vaccines are licensed in Europe, only one of which (Vaxelis, Hex-V), uses a meningococcal outer membrane protein complex as a carrier protein for Haemophilus influenzae type b (Hib), creating potential interactions with the meningococcal vaccine 4CMenB.

Methods:: In this single-centre open-label randomised trial, infants were randomised in a 1:1 ratio to receive Hex-V or an alternative hexavalent vaccine (Infanrix-Hexa, Hex-IH) at 2, 3 and 4 months with 4CMenB (2, 4, 12 months) in the UK routine immunisation schedule. The primary outcome was non-inferiority of geometric mean concentrations (GMCs) of anti-PRP (Hib) IgG at 5 months of age. Secondary outcomes included safety, reactogenicity, and immunogenicity of other administered vaccines measured at 5 and 13 months of age.

Results: Of the 194 participants enrolled, 96 received Hex-V and 98 Hex-IH. Non-inferiority of anti-PRP IgG GMCs at 5 months of age in participants receiving Hex-V was established; GMCs were 23-times higher following 3 doses of Hex-V than 3 doses of Hex-IH (geometric mean ratio (GMR) 23.25; one-sided 95% CI 16.21, -). 78/85 (92%) of Hex-V recipients and 43/87 (49%) of Hex-IH recipients had anti-PRP antibodies ≥ 1.0 $\mu\text{g/ml}$ (Figure). At 5 months of age serum bactericidal activity titres against MenB strain 5/99 were higher following Hex-V than Hex-IH (GMR 1.56; 95% CI 1.13-2.14). The reactogenicity profile was similar in both groups.

Figure: Reverse cumulative distribution curves of anti-PRP concentrations and hSBA titres at 5 months of age

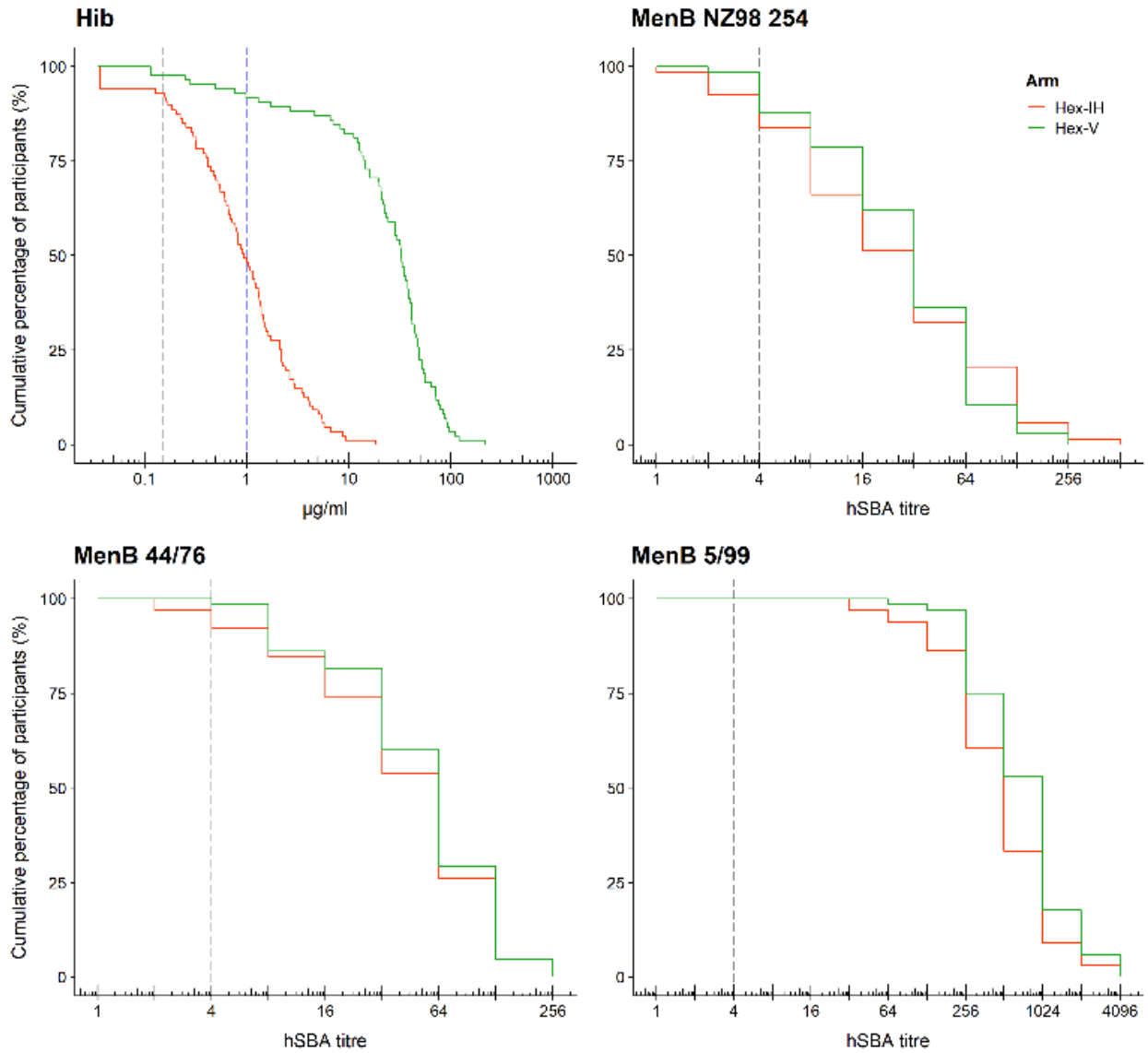

Conclusions/Learning Points: These data support flexibility in the use of either Hex-IH or Hex-V in infant immunisation schedules containing 4CMenB, with the possibility that Hex-V may enhance protection against Hib.

PD112 / #1826

TWENTY-SEVEN YEARS OF POST-MARKETING PASSIVE SAFETY SURVEILLANCE OF THE LIVE-ATTENUATED VARICELLA VIRUS-CONTAINING VACCINE

E-Posters

POSTER DISCUSSION SESSION 06: VACCINE I

Tina Singh¹, Giacomo Casabona¹, Volker Vetter², Fanny Hergibo¹

¹GSK, Gsk, Wavre, Belgium, ²GSK, Gsk, Munich, Germany

Backgrounds: GSK's monovalent varicella vaccine is a lyophilized preparation of the live-attenuated Oka strain of varicella-zoster virus, indicated for active immunization against varicella in healthy individuals (≥ 9 -month-olds) and patients at high risk of severe varicella. Its effectiveness and safety have been demonstrated in various clinical settings and it is currently approved in >23 European Union countries and >60 other countries. Here, we provide an overview of the post-marketing passive surveillance through spontaneous adverse event (AE) reporting following vaccination with GSK's monovalent varicella vaccine.

Methods:: Spontaneous AE reports were collected from GSK's Global Safety Database between 17-October-1994 and 01-November-2021 (data lock point). Reporting trends for certain cases of interest that reported pyrexia, rash and herpes zoster were analyzed.

Results: Between 1994-2021 it was estimated that 93,858,447 doses of monovalent varicella vaccine were distributed, and 13,805 spontaneous AE reports following vaccination were retrieved and analyzed. The proportion of spontaneous AEs reported dropped from 345.42 in 1994 to 5.66 cases/100,000 doses distributed (DD) in 2021. Over 27 years, the proportion of serious AEs reported cumulatively was substantially lower compared to non-serious ones (5.03 vs 9.68 cases/100,000 DD). The incidence of pyrexia, which was commonly reported in clinical trials following vaccination, remained stable over time after a peak in 1994, varying between 0.80-172.71 cases/100,000 DD (median: 2.59). The cases reporting rash and herpes zoster did not show a trend of increased incidence over time and varied between 0.36-3.76 cases/100,000 DD (median: 0.81) and 0.11-0.70 cases/100,000 DD (median: 0.29), respectively.

Conclusions/Learning Points: The 27 years of post-marketing safety surveillance showed that the safety profile of the monovalent varicella vaccine is consistent with that previously observed in clinical trials with no new safety concerns identified. Funding: GlaxoSmithKline Biologicals SA

LONG TERM ESTHETIC AND FUNCTIONAL OUTCOMES IN CHILDREN WITH NONTUBERCULOUS MYCOBACTERIAL LYMPHADENITIS

E-Posters

POSTER DISCUSSION SESSION 07: NON-RESPIRATORY INFECTIONS

Angela Manzanares¹, Marta Nabal², María Collada², Carmen González², Estrella Esquivel³, María Dolores Delgado⁴, Eunáte Martí⁴, Jesús Redondo⁴, Paula López-Roa⁵, Nuria Alberti⁶, Elisa Fernandez-Cooke¹, Luis Prieto¹, Cinta Moraleda¹, Cristina Epalza¹, Serena Villaverde¹, Pablo Rojo¹, Daniel Blázquez-Gamero^{1,2,3}

¹Hospital 12 de Octubre, Pediatric Infectious Disease Unit, Madrid, Spain, ²Universidad Complutense, ., Madrid, Spain, ³Instituto de Investigación Hospital 12 de octubre, ., Madrid, Spain, ⁴Hospital 12 de Octubre, Pediatric Plastic Surgery, Madrid, Spain, ⁵Hospital 12 de Octubre, Microbiology Department, Madrid, Spain, ⁶Hospital 12 de Octubre, Pathology Department, Madrid, Spain

Backgrounds: The best management of lymphadenitis caused by non-tuberculous mycobacteria (NTB) is still controversial. Our aim was to evaluate long-term esthetic and functional outcomes and the patient/parent's global in NTB lymphadenitis.

Methods: A retrospective observational study (2003-2020) in a University Hospital in Madrid was performed. Children with histological findings compatibles with NTB lymphadenitis and/or NTB isolated in samples were included. Families were contacted by telephone to complete a standardized questionnaire on global satisfaction, esthetic, and functional outcomes. Current anonymized photographs of the scars were evaluated by two blinded clinicians. Scars were assessed using the POSAS (Patient and Observer Scar Assessment Scale) scales.

Results: 77 children were included. Median age was 2(IQR: 1,5-2,6) years and 46(59.7%) were women. In 57(64%) children complete excision was performed as the first treatment, wait-and-watch in 9(11.7%) children, antibiotics without surgery in 7(9.1%) children. Among 62 children that underwent complete excision (as first line or as rescue treatment) 11 (17.7%) had permanent facial palsy. Children were very/moderately satisfied with outcomes in 70% (46/66), parents in 75.5% (49/65; 75.5%). Facial palsy was more common in the group of dissatisfied children (p=0.013). Median scar score (POSAS scale) was not associated with patient or parents satisfaction.

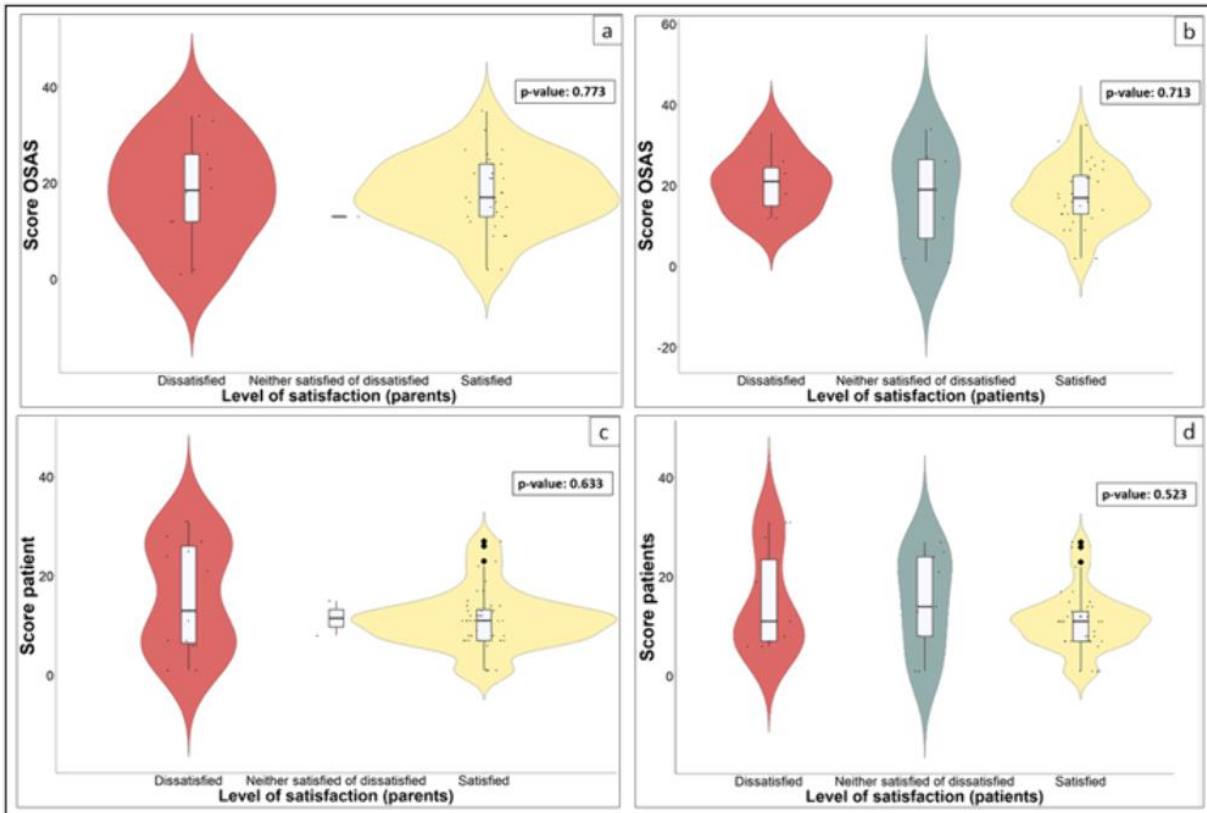

Conclusions/Learning Points: Facial palsy has a greater impact than esthetics of the scar on the degree of satisfaction of the children. There is a high percentage of permanent facial palsy after complete excision surgery in our sample and other options, like wait-and-watch approach, should be offered to the families.

PD114 / #917

WGS ANALYSIS OF CAPSULAR GENES OF NEISSERIA MENINGITIDIS ISOLATES FROM PATIENTS WITH INVASIVE MENINGOCOCCAL DISEASE AND HEALTHY CONTACTS

E-Posters

POSTER DISCUSSION SESSION 07: NON-RESPIRATORY INFECTIONS

Michal Honskus

The National Institute of Public Health, Centre For Epidemiology And Microbiology, Prague, Czech Republic

Backgrounds: Within the project whose aim is to add to the body of knowledge on virulence factors of *Neisseria meningitidis*, capsular genes were subjected to whole genome sequencing (WGS) analysis.

Methods: Three groups of clinically and/or epidemiologically related *N. meningitidis* isolates (a total of seven isolates) were analysed by WGS. Groups 1 and 2 included isolates from a single patient with invasive meningococcal disease (IMD) from different clinical specimens. Group 3 consisted of two isolates: one from a patient with IMD and the other from his close healthy contact. WGS analysis was used to determine allelic variants of MLST genes, MenB vaccine antigen genes, *porA* and *fetA* variable region genes, and allelic variants of genes of capsule regions A, B, and C.

Results: Group 1 isolates differed in the capsular polymerase gene, *csb*. While two serogroup B isolates carried active allele 37, the third isolate contained inactivated allele 28. This alteration was caused by a single nucleotide insertion and resulted in the inability of the bacterium to synthesise the capsular protein. Group 2 isolates also differed in the capsular polymerase gene *csb*. In this case, there was a mutation in active allele 13, resulting in inactive allele 120. Group 3 isolates differed in the *cssE* gene. The IMD isolate contained allele 45 while the contact isolate had allele 1.

Conclusions/Learning Points: Different allelic variants of the capsular region A genes were found in clinically and/or epidemiologically related *N. meningitidis* isolates. The study isolates did not differ in any other genes. Project support Supported by the programme project of the Ministry of Health of the Czech Republic under reg. no. NV19-09-00319. All intellectual property rights reserved.

PD115 / #1178

COMPARISON OF SEROTYPES CAUSING INVASIVE VERSUS NON-INVASIVE PNEUMOCOCCAL DISEASE IN CHILDREN UNDER 5 YEARS OF AGE, CZECH REPUBLIC, 2014-2020

E-Posters

POSTER DISCUSSION SESSION 07: NON-RESPIRATORY INFECTIONS

Sandra Vohrnová, Jana Kozáková

National Institute of Public Health, Centrum For Epidemiology And Microbiology, Prague, Czech Republic

Backgrounds: The aim of this work is to compare serotypes causing invasive pneumococcal disease (IPD) with serotypes from noninvasive pneumococcal disease (non-IPD) in children under 5 years of age in the Czech Republic.

Methods: In the Czech Republic, the active surveillance of IPD has been established since 2007. Surveillance of non-invasive cases is not implemented. In 2014–2020, 353 cases of pneumococcal disease in children aged 0–4 years were reported to National Reference Laboratory for Streptococcal Infections. 143 isolates were from IPD (mostly meningitis, sepsis, pneumonia with sepsis) and 210 isolates were from non-IPD (mostly infections of upper respiratory tract and acute otitis media).

Results: The three most frequent serotypes causing IPD as well as non-IPD in children under 5 years of age were serotype 3 (20,9% of IPD, 23,9% of non-IPD), 19A (14,7% of IPD, 19% of non-IPD) and 10A (4,2% of IPD, 5,2% of non-IPD). The fourth most frequent serotype in IPD cases was 14 (3,5%), followed by serotypes 6B, 22F, 23B, 35F (2,8% each). In non-IPD cases the fourth most common serotype was 19F (4,7%), followed by 15C and 23B (4,3% each). In total, 50,3% of IPD and 55,2% of non-IPD cases were caused by serotypes preventable by pneumococcal conjugate vaccines.

Conclusions/Learning Points: Of the 353 IPD and non-IPD cases, a total of 44.7% were caused by three serotypes (3, 19A, 10A). More than half of IPD as well as non-IPD cases were caused by serotypes which are included in currently used pneumococcal conjugate vaccines.

STREPTOCOCCUS PNEUMONIAE MENINGITIS AND/OR SEPTICEMIA AND SEROTYPE SURVEILLANCE IN CHILDREN, DURING 2010-2021 IN GREECE

E-Posters

POSTER DISCUSSION SESSION 07: NON-RESPIRATORY INFECTIONS

Athanasia Xirogianni¹, Nektarios Maramaras¹, Theano Georgakopoulou², Ioanna Magaziotou², Elpidoforos Mantadakis³, Emmanuel Roilides⁴, Vassiliki Papaevangelou⁵, Maria Tsolia⁶, Georgina Tzanakaki¹

¹University of West Attica, National Meningitis Reference Laboratory, Department Of Public Health Policy, Athens, Greece, ²National Public Health Organization, Department For Vaccine Preventable Diseases & Congenital Diseases, Directorate Of Epidemiological Surveillance And Interventions For Infectious Diseases, Athens, Greece, ³University of Thace, Dept Of Paediatrics, Alexandroupolis, Greece, ⁴Aristotle University of Thessaloniki, Infectious Diseases Unit, 3rd Pediatric Department, Thessaloniki, Greece, ⁵National and Kapodistrian University of Athens, Third Department Of Pediatrics, Attikon University Hospital, Athens, Greece, ⁶School of Medicine, National and Kapodistrian University of Athens, 2nd Department Of Pediatrics, "p. & A. Kyriakou" Children's Hospital, Athens, Greece

Backgrounds: S. pneumoniae remains a leading cause of meningitis and/or septicemia worldwide, especially among children <2 years old, who are at higher risk of pneumococcal disease. The introduction of pneumococcal conjugate vaccines (PCV) has changed the epidemiology of the disease.

Methods: During 2010-2021, 155 cases of S. pneumoniae meningitis and/or septicemia were studied in children up to 16 years. S. pneumoniae and serotype was identified by molecular methods (mPCR and CST).

Results: The overall incidence was 1.31/100,000, ranging from 1.62 in children 0-4 years old to 0.06 in adolescents. Among the notified cases, septicemia was the main clinical presentation (40.6%), followed by meningitis (38.7%) and septicemia and meningitis (20.6%). Case fatality ratio was 3.87%. During the study period, a decrease in PCV-13 serotypes was observed with a simultaneous increase of the non-PCV-13 serotypes. Specifically, this increase was observed at the age of 0-4 years old (29.9% vs 70.1%) and 5-9 years of age (33.3% vs 66.6%) for the PCV-13 and non-PCV-13 serotypes respectively. A high variation among the serotypes was observed in all age groups as 30 serotypes were detected. The most predominant serotypes in children 0-4 years old were 15B/C (11.7%) and 24F/40 (13.0%) followed by 19A, 12F, 35F/47F, 8, 10A, 21 and 23A. Among the 21 patients 5-9 years old, serotype 3 was predominant (4/21; 19%), followed by 23A, 23B and 15B/C. The persistence of serotypes 3 and 19A were related to their specific characteristics as they are the most prevalent among the vaccine failure cases.

Conclusions/Learning Points: Close monitoring and continuous surveillance of evolving serotypes is of high importance during the post PCV-13 era and crucial for the evaluation of the overall impact of pneumococcal vaccination programs and for designing future strategies.

LOCATIONS OF ARTHRITIS AND CLINICAL MANIFESTATIONS IN PEDIATRICS WITH REACTIVE ARTHRITIS CAUSED BY GIARDIASIS: A GLOBAL SYSTEMATIC REVIEW

E-Posters

POSTER DISCUSSION SESSION 07: NON-RESPIRATORY INFECTIONS

Javad Mahdavi¹, Reza Ghasemikhah^{2,3}

¹Arak University of Medical Sciences, Students Research Committee, Arak, Iran, ²Arak University of Medical Sciences, Infectious Diseases Research Center (idrc), Arak, Iran, ³Arak University of Medical Sciences, Department Of Parasitology And Mycology, School Of Medicine, Arak, Iran

Backgrounds: Reactive arthritis (ReA) is an inflammatory spondyloarthritis occurring during or after gastrointestinal and genitourinary infections. One of the rare etiologic agents is giardiasis which is a common waterborne parasitic infection of the human intestine, especially in pediatrics throughout the worldwide. The aim of this study was to assess locations of arthritis and clinical manifestations in pediatrics with ReA caused by giardiasis.

Methods: This study is a systematic review that followed the PRISMA checklist. Searching in PubMed, Web of Science, Scopus, ScienceDirect, and Google Scholar was performed without language restriction up to 2021. Article screening and data extraction were conducted by two independent authors.

Results: A total of 7 studies describing 81 cases were included. Among the patients, 46 were male and 35 were female, ranging in age from 19 months to 17 years. The most affected joints were the knee and ankle in 69% and 33%, respectively. Other joint symptoms included hip (16%), wrist (10%), elbow (7%), shoulder (4%), metatarsophalangeal (2%), and proximal interphalangeal (1%). Laboratory data analysis revealed: giardia cysts in stool (90%), increased erythrocyte sedimentation rate (40%), slight decrease in hemoglobin (32%), and blood in stool (5%). Possession of the human leukocyte antigen B27 (HLA-B27) and eosinophilia were also observed in 67% and 8% of measured cases, respectively. The most prevalent extra-articular manifestation was allergic symptoms (53%), followed by abdominal pain (46%), diarrhea (44%), anorexia (36%), constipation (30%), nausea/vomiting (16%), and fever (15%).

Conclusions/Learning Points: One of the complications of giardiasis in pediatrics is ReA, so it is necessary that one of the differential diagnoses in them is giardiasis to prevent various joint complications with timely diagnosis and appropriate treatment. Also, pediatrics with giardiasis should be evaluated for joint health.

PD118 / #1326

MOLECULAR EPIDEMIOLOGY OF UNUSUAL G OR P ROTAVIRUS A GENOTYPES IN CHILDREN WITH GASTROENTERITIS

E-Posters

POSTER DISCUSSION SESSION 07: NON-RESPIRATORY INFECTIONS

Charilaos Dellis, Elizabeth- Barbara Tatsi, Dimitra Maria Koukou, Panagiota Chatzichristou, Athanasios Michos, Vassiliki Syriopoulou
"Aghia Sophia" Children's Hospital, Division Of Infectious Diseases, First Department Of Pediatrics, Medical School, National And Kapodistrian University Of Athens, Athens, Greece, Athens, Greece

Backgrounds: The aim of this study was to monitor the annual distribution of unusual G or P (G/P) Rotavirus (RV) genotypes and to molecularly characterize their I and E genotypes.

Methods: Demographic data and fecal samples positive for RV were collected from children ≤ 14 years old, hospitalized in 8 Pediatric Departments during 09/2008-08/2021. G, P, I and E typing was performed employing RT-PCR and Sanger sequencing of the VP7, VP4, VP6 and NSP4 genes, respectively.

Results: From 3740 RV positive children participated in the study, 60 (1.6%) had been infected by an unusual G (G6, G8, G10) or P (P6, P9, P10, P11, P14) genotype. Their median age was 20.50 months (IQR: 36.85) and males outnumbered females (42/60). No unusual G/P genotype was detected in 09/2012-08/2013 and 09/2014-08/2017, while a peak was detected in 09/2019-08/2020 (9.62%). The seasonal peak of unusual G/P genotypes was in spring (41.66%) and fall (33.33%). I and E genotypes were determined in 31/60 of G/P unusual strains (51.66%). I2-E2 was the most common combination (38.70%) followed by I2-E3 (29.03%), which was not detected before 2017. Significant differences in days of hospitalization were found between E2 and E3 (4 vs 2 days, $p=0.009$). A wide range of G-P-I-E genotype combinations was identified with most common the G3-P[9]-I2-E3 (22.58%), G8-P[14]-I2-E2 (12.90%), G3-P[9]-I2-E2 (6.45%) and G9-P[10]-I1-E1 (6.45%). Children infected by G8-P[14]-I2-E2 genotype were older with mean age (\pm SD) 72.2 months (\pm 23.62).

Conclusions/Learning Points: In this study an increase of unusual G or P genotypes was noticed the last 3 years and I2-E2 was the most common I-E combination. Seasonality of the unusual RV was observed in spring and fall. Children infected by E2 RV genotype had significantly longer duration of hospitalization.

BURDEN OF ANTIBIOTIC USE AMONG PEDIATRIC PATIENTS WITH VARICELLA INFECTION: A RETROSPECTIVE COHORT ANALYSIS OF REAL-WORLD DATA IN ENGLAND

E-Posters

POSTER DISCUSSION SESSION 07: NON-RESPIRATORY INFECTIONS

Stephanie Kujawski¹, Victoria Banks², Caroline Casey², Simon Drysdale³, Amisha Patel², Olivia Massey², Tim Holbrook², Manjiri Pawaskar¹

¹Merck & Co., Inc., Center For Observational And Real-world Evidence, Kenilworth, United States of America, ²Adelphi Real World, N/a, Bollington, United Kingdom, ³ST GEORGE'S UNIVERSITY HOSPITALS NHS FOUNDATION TRUST, Paediatric Infectious Diseases, LONDON, United Kingdom

Backgrounds: Antibiotic use is on the rise globally with corresponding increases in antimicrobial resistance. The extent to which antibiotics are used for the management and treatment of varicella and its associated complications in England is not well documented. This study assessed antibiotic use for varicella and its associated complications in England.

Methods: In this retrospective cohort study, we used linked primary and secondary healthcare data from England (Clinical Practice Research Datalink Aurum and Hospital Episode Statistics). Patients <18 years of age with a first varicella diagnosis during January 2014–December 2018 with 3-month follow-up available were included. We assessed varicella-related complications and medication use on the date of diagnosis and any time in the 3-month follow-up period. Medication use was determined in primary care only by assessing prescriptions corresponding to the National Health Service code dictionary of medicines.

Results: 114,604 patients met the inclusion criteria. The mean age at diagnosis was 4.0 years [SD 2.8] and 48.7% were female. 7.7% (n=8,820) of patients had ≥1 varicella-related complication. The top complications were ear, nose, and throat conditions (37.1%, n=3,272), ophthalmic infections (19.3%, n=1,698), and skin infections (16.3%, n=1,434). In primary care (n=103,528), 28.7% (n=29,706) were prescribed any antibiotics; 21.7% (22,517/103,528) were prescribed systemic antibiotics and 10.2% (10,589/103,528) non-systemic antibiotics. The most prescribed antibiotics were amoxicillin (35.4%, 10,504/29,706) and flucloxacillin (19.6%, 5,826/29,706). A higher proportion of patients with varicella-related complications were prescribed antibiotics compared with those without complications (69.5% vs. 25.2%).

Conclusions/Learning Points: Over one-quarter of children with a varicella diagnosis were treated with antibiotics in England. Antibiotic use was greater in patients with a varicella-related complication recorded. Varicella vaccination may reduce complication frequency and mitigate the need for antibiotic use for varicella.

INCIDENCE, CLINICAL CHARACTERISTICS, AND OUTCOME OF EARLY LYME NEUROBORRELIOSIS IN CHILDREN AND ADULTS PRESENTING IN AN ENDEMIC AREA IN THE NETHERLANDS

E-Posters

POSTER DISCUSSION SESSION 07: NON-RESPIRATORY INFECTIONS

Reitze Bruinsma¹, Anusha Van Samkar², Yolande Vermeeren³, Renske Wieberdink⁴, Thomas Van Bemmel³, Barend Van Kooten⁴, Tizza Zomer²

¹Gelre hospitals, Department Of Pediatrics, Apeldoorn, Netherlands, ²Gelre hospitals, Lyme Center Apeldoorn, Apeldoorn, Netherlands, ³Gelre hospitals, Department Of Internal Medicine, Apeldoorn, Netherlands, ⁴Gelre hospitals, Department Of Neurology, Apeldoorn, Netherlands

Backgrounds: Lyme neuroborreliosis (LNB) is a tick-borne infection caused by *Borrelia burgdorferi* which can affect the central and peripheral nervous system in adults and children. The clinical course of LNB can be different in adults and children. However, studies comparing these differences are scarce. The aim of this study was to compare clinical characteristics and prognosis of LNB between children and adults.

Methods: We performed an observational retrospective study among patients with LNB who presented at Gelre hospital from 2007 to 2020 and had CSF pleocytosis. Data were collected from electronic medical records concerning age, gender, tick bites, clinical manifestations, results of laboratory investigations, treatment, and recovery.

Results: Identified were 127 patients with early LNB. Included were 58 children (median age eight years) and 69 adults (median age 56 years). The incidence of early LNB was 3.3 per 100,000 inhabitants per year. The most common neurological manifestation in adults and children was facial nerve palsy (67%), although in children, this was more prevalent (86%) than in adults (51%) ($P < 0.001$). Headache was more prevalent in children (59%) than in adults (32%) ($P = 0.003$). (Poly)radiculitis was more prevalent in adults (33%) than in children (3%) ($P < 0.001$). Encephalitis was only reported in adults (10%). In children the time from first symptoms to diagnosis was shorter (10 days vs. 28 days in adults, $P < 0.001$). Complete recovery was reported more often in children (83%) compared to adults (40%) ($P < 0.001$).

Conclusions/Learning Points: Early LNB in the Netherlands presents with facial nerve palsy in the majority of patients, especially in children. Headache is more frequently reported in children. Radiculitis and encephalitis are mostly reported in adults. Complete recovery after standard antibiotic therapy is better in children than in adults.

SIGNIFICANT TRANSCRIPTIONAL DIFFERENCES UNDERLIE CLINICAL PHENOTYPE DIFFERENTIATION OF CHILDREN WITH ACUTE HEMATOGENOUS OSTEOMYELITIS

E-Posters

POSTER DISCUSSION SESSION 07: NON-RESPIRATORY INFECTIONS

Lawson Copley¹, Prithvi Raj², Gowrishankar Muthukrishnan³, Yared Kidane⁴, Ahmad Hachem⁵

¹University of Texas Southwestern, Pediatric Orthopaedic Surgery, Dallas, United States of America, ²University of Texas Southwestern, Immunology And Genetics, Dallas, United States of America, ³University of Rochester Medical Center, Orthopaedics Center For Musculoskeletal Research, Rochester, United States of America, ⁴Texas Scottish Rite Hospital, Bioinformatics, Dallas, United States of America, ⁵University of Texas Southwestern, Pediatric Infectious Disease, Dallas, United States of America

Backgrounds: Children with acute hematogenous osteomyelitis (AHO) demonstrate broad clinical phenotype variation. Substantial genomic heterogeneity exists amongst *Staphylococcus aureus* (SA) isolates of children with AHO. It is uncertain if bacterial transcriptional variation impacts clinical phenotype differentiation. The purpose of this study is to determine if there are transcriptional differences among SA strains isolated from children with mild, moderate, and severe illness.

Methods:: Clinical SA isolates from children with AHO having mild, moderate, and severe illness were grown in triplicate under controlled conditions in Mueller Hinton Broth. RNA isolation and sequencing were performed at 6 timepoints over 4 hours. RNA sequencing libraries were prepared and differentially expressed gene (DEG) analysis followed the NASA RNA-Seq consensus pipeline to provide DEGs sorted by adjusted p-value and log fold-change. Principle Component Analysis (PCA), Gene Ontology (GO), and Kyoto Encyclopedia of Genes and Genomes (KEGG) enrichment pathways were assessed at each timepoint.

Results: SA isolates demonstrated distinctive growth curve patterns. Mild isolates grew faster and with a steeper log-phase than moderate or severe. PCA demonstrated unique transcriptional behavior between the strains at specific timepoints. GO showed significantly differentiated translation, ribosome activity, glycolytic, and biosynthetic processes. KEGG depicted significantly differentiated pathways with over-expressed behaviors of SA infection, bacterial invasion, and ABC transporters of the moderate and severe strains when compared to the mild strain which favored pathways of biosynthesis and metabolism.

Conclusions/Learning Points: This study demonstrates unique transcriptional pathways of SA strains isolated from children with mild, moderate and severe phenotypes of AHO. While limited by in vitro methodology and inability to account for host immunologic response the profound differences of growth and transcription observed in this study establish a tendency of SA to make trade-offs between growth/metabolism or virulence.

MANAGEMENT OF INFANTS 29-60 DAYS OLD HOSPITALIZED WITH FEVER: TIME TO REVISIT PRACTICE GUIDELINES?

E-Posters

POSTER DISCUSSION SESSION 07: NON-RESPIRATORY INFECTIONS

Irini Eleftheriou¹, Ariadni Neofytou¹, Anastasios Doudoulakakis², George Kalogeras², Katerina Tsiligianni², Evaggelia Eirini Vetouli², Evangelia Lebessi², Maria Tsolia¹, Nikos Spyridis¹

¹National and Kapodistrian University of Athens, Second Department Of Paediatrics, "p. & A. Kyriakou" Children's Hospital, Athens, Greece, ²"P. & A. Kyriakou" Children's Hospital, Department Of Microbiology, Athens, Greece

Backgrounds: Management of febrile infants 29-60 days old is challenging. Recommendations from published practice guidelines differ as to whether lumbar puncture (LP) should be performed as part of sepsis evaluation leading to significant variation in clinical practice.

Methods:: This is a retrospective study of all febrile infants 29-60 days old hospitalized at a tertiary Children's Hospital in Athens, Greece between 2014-2021 who underwent full sepsis evaluation. The aim of the study was to examine the rate of meningitis in this age group in order to provide further insight in their clinical management. For this purpose, microbiological and clinical data were reviewed.

Results:

| | Number of cases |
|--|-----------------|
| Full sepsis screen | 531 |
| Bacterial meningitis (%) | 2 (0.37) |
| - <i>Neisseria meningitidis</i> | 1 |
| - <i>Listeria monocytogenes</i> | 1 |
| Bacteraemia* (%) | 22 (4.1) |
| - <i>Escherichia coli</i> | 7 |
| - <i>Klebsiella pneumoniae</i> | 4 |
| - <i>Streptococcus</i> group B | 2 |
| - <i>Staphylococcus aureus</i> | 3 |
| - <i>Haemophilus influenzae</i> type B | 1 |
| - <i>Enterococcus faecium</i> | 1 |
| - <i>Enterobacter cloacae</i> | 1 |
| - <i>Neisseria meningitidis</i> | 1 |
| - <i>Peptostreptococcus</i> | 1 |
| - <i>Streptococcus anginosus</i> | 1 |
| Urinary tract infection* (%) | 114 (21.5) |
| - <i>Escherichia coli</i> | 91 |
| - <i>Klebsiella pneumoniae</i> | 12 |
| - <i>Enterococcus faecalis</i> | 5 |
| - <i>Pseudomonas aeruginosa</i> | 3 |
| - <i>Enterobacter aerogenes</i> | 1 |
| - <i>Enterobacter cloacae</i> | 1 |
| - <i>Klebsiella oxytoca</i> | 1 |

*10 infants had urinary tract infection and bacteraemia (urosepsis)

Table 1. Bacterial infections and pathogens identified in febrile infants 29-60 days old

Of 840 febrile infants hospitalized between 2014 and 2021, 531 (63.2%) underwent full sepsis evaluation. Median age was 41 days (33-51) and 57.8% (307/531) were males. One hundred fifty-one (28.4%) cases had bloody/traumatic LP. CSF pleocytosis (WBCs ≥ 10/mm³) was identified in 16.6% (88/531). Two infants -30 and 32 days old- were diagnosed with bacterial meningitis, 4.1% (22/531) with bacteraemia and 21.5% (114/531) with urinary tract infection (Table 1). Amongst the latter none had meningitis. After full sepsis evaluation, in 29.4% (156/531) of the cases no specific infection was diagnosed while in 9.2% (49/531) final diagnosis was not indicative of infection.

Conclusions/Learning Points: Bacterial meningitis in this cohort of infants 29-60 days old presenting with fever is very rare indicating that LP should be preserved for ill-appearing children. After full

evaluation, diagnosis remains largely unspecified. Practice guidelines for this age group should be revisited using the best currently available data.

IS KAWASAKI DISEASE CAUSED BY A VIRUS?

E-Posters

POSTER DISCUSSION SESSION 07: NON-RESPIRATORY INFECTIONS

Kenneth Rand¹, Sumita Bhaduri-Mcintosh², Alyssa Harris³

¹University of Florida, Department Of Pathology, Immunology And Laboratory Medicine, Gainesville, United States of America, ²University of Florida, Pediatrics, Gainesville, United States of

America, ³Vizient, Inc, Center For Advanced Analytics & Informatics, Chicago, United States of America

Backgrounds: Background Kawasaki Disease (KD) is characterized by high fever, rash, cervical lymphadenopathy, conjunctival injection, oral mucous membrane changes, and swelling of the extremities followed by skin sloughing. Despite ≥50 years of study, no bacterial, viral or other infectious agent has been consistently associated with the illness. In the US, Covid 19 led to lockdown/social distancing in March 2020 that in turn led to the virtual disappearance of all respiratory viruses for months. If seasonal respiratory viruses were associated with KD, KD should have declined in parallel with the striking drop in respiratory viruses in 2020.

Methods:: Methods Weekly virus positivity rates were obtained from BioFire Diagnostics RP2 respiratory virus panel from Syndromic Trends <https://syndromictrends.com/>. Monthly KD incidence was obtained from the principal ICD-10-CM code in the Vizient® Clinical Data Base (CDB) (with permission of Vizient, Inc. all rights reserved).

Results: Results The lockdown and social distancing in March 2020 led to a 50 – 90% decrease from baseline of all respiratory viruses between March and May 2020, but no comparable change in the incidence of KD. Bacteria on the respiratory viral panel e.g.. Mycoplasma pneumonia, Chlamydomphila pneumoniae, Bordetella likewise did not decrease during April-May 2020. Miscoding MIS-C as KD is unlikely to account for the KD cases in April-May 2020 since the rate of MIS-C in hospitalized pediatric Covid patients is low (6.9%) <https://jamanetwork.com/journals/jamanetworkopen/fullarticle/2788844>, Even adjusting for possible MIS-C cases in the Vizient CDB, persistence of KD cases is in contrast to the overall decrease in respiratory viruses.

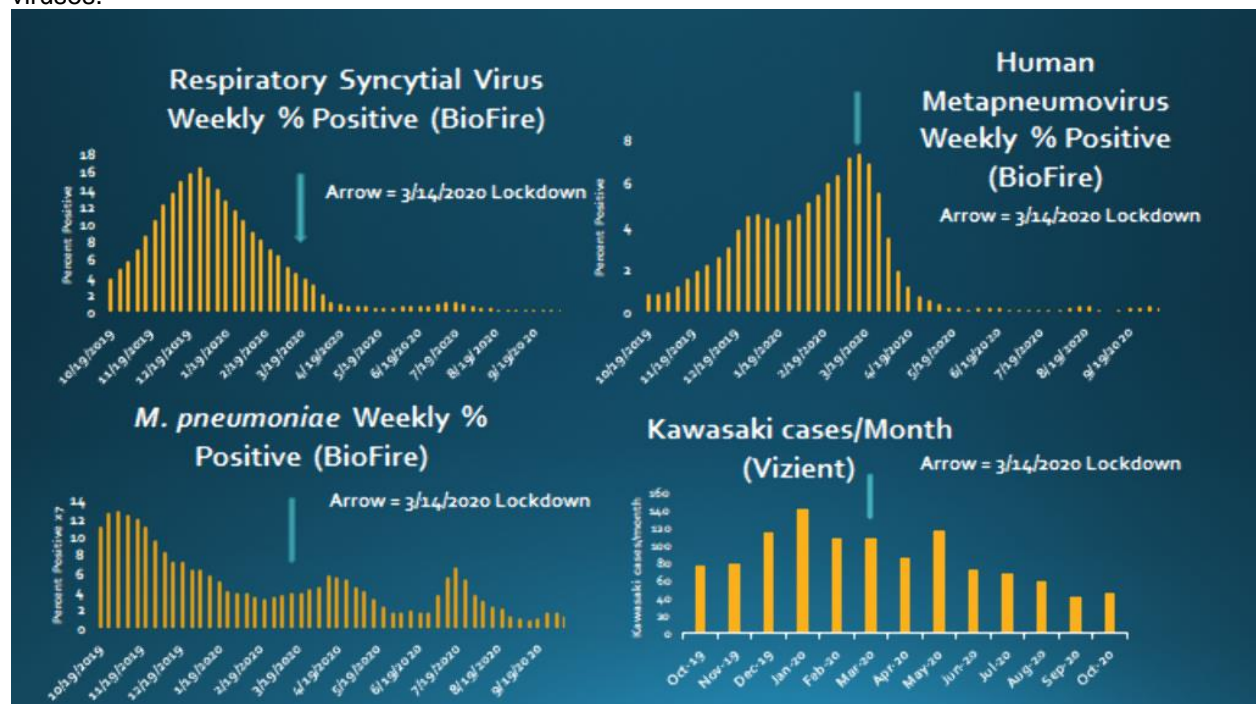

Conclusions/Learning Points: Conclusions While these data do not exclude a viral etiology, the incidence of KD immediately post lockdown paralleled that of bacterial pathogens suggesting a bacterial pathogen or non-infectious trigger as the cause of KD.

PD124 / #873

ANTI-TNF AGENTS IMPAIR SEROPROTECTION IN PAEDIATRIC PATIENTS WITH JUVENILE IDIOPATHIC ARTHRITIS AND INFLAMMATORY BOWEL DISEASE AFTER MENINGOCOCCAL ACWY VACCINATION

E-Posters

POSTER DISCUSSION SESSION 08: VACCINE II

Milou Ohm¹, Marc Jansen², Anne Jasmijn Sellies², Gerrie De Joode², Frans Verduyn-Lunel³, Guy Berbers¹, Nico Wulffraat²

¹National Institute for Public Health and the Environment, IIV, Bilthoven, Netherlands, ²University Medical Center Utrecht, Pediatric Immunology And Rheumatology, Utrecht, Netherlands, ³University Medical Center Utrecht, Microbiology And Virology, Utrecht, Netherlands

Backgrounds: In 2018, a mass campaign for 14-18 year-olds with a meningococcal ACWY (MenACWY) vaccine took place in the Netherlands, due to rising numbers of invasive meningococcal W disease. We investigated immunogenicity and safety of MenACWY vaccination in paediatric patients with Juvenile Idiopathic Arthritis (JIA) and Inflammatory Bowel Disease (IBD), and studied the effect of biological DMARDs on seroprotection.

Methods: Pediatric patients with immune disorders were included in a prospective study and samples at baseline and 3, 12 and 24 months after vaccination with a MenACWY-TT vaccine. We measured immunogenicity for meningococcal serogroup ACWY using a fluorescent bead-based multiplex immunoassay with an arbitrary cut-off of 2 µg/ml for protection. Alterations in disease activity were measured with use of the following score instruments: cJADAS-27 (JIA), PCDAI (Crohn's disease) or PUCAI (ulcerative colitis).

Results: 222 patients were included (41% male). Median age was 16 years (range 15-19). 80% of the patients was using immunosuppressive drugs of which 47% biologicals, which were all anti-TNF agents. The proportions protected 12 months postvaccination for MenA, MenC, MenW and MenY were 45%, 91%, 36% and 48% respectively, compared to 94% for MenACWY in healthy controls. There was a significant difference in seroprotection rates in patients using anti-TNF versus no TNF agents at 12 months postvaccination: for MenC 100 versus 90%, MenW 61% versus 21%, and MenY 77% versus 31%. The vaccination did not aggravate disease activity and no severe adverse events were observed.

Conclusions/Learning Points: The MenACWY vaccine is well tolerated in pediatric JIA and IBD patients but less immunogenic compared to healthy controls. Seroprotection rates at 12 months postvaccination are significantly lower in patients treated with anti-TNF agents.

DISTRIBUTION OF SEROTYPES CAUSING INVASIVE PNEUMOCOCCAL DISEASE IN CHILDREN FROM HIGH-INCOME COUNTRIES IN EUROPE AND THE IMPACT OF PEDIATRIC PNEUMOCOCCAL VACCINATION

E-Posters

POSTER DISCUSSION SESSION 08: VACCINE II

Lindsay Grant¹, Mary Slack², Christian Theilacker³, Jelena Vojicic⁴, Stéphane Dion⁴, Ralf-Rene Reinert⁵, Luis Jodar¹, Bradford Gessner¹

¹Pfizer Vaccines, Medical Development And Scientific Clinical Affairs, Collegetown, United States of America, ²Griffith University, School Of Medicine & Dentistry, Southport, Australia, ³Pfizer Pharma GmbH, Medical Development And Scientific Clinical Affairs, Berlin, Germany, ⁴Pfizer Canada ULC, Medical Development And Scientific Clinical Affairs, Montreal, Canada, ⁵Pfizer, Medical Development And Scientific Clinical Affairs, Paris, France

Backgrounds: The introduction and adoption of pneumococcal conjugate vaccines (PCVs) into pediatric national immunization programs (NIPs) has led to large decreases in invasive pneumococcal disease (IPD) incidence caused by vaccine serotypes. Despite these reductions, the IPD burden in children remains significant.

Methods: We collected serotype-specific IPD data from surveillance systems or hospital networks from 19 high-income countries in Europe that met inclusion criteria. Data sources included online databases, surveillance system reports, peer-reviewed literature, and personal communication with in-country investigators. Percentages were calculated for all countries combined and by the type and duration of PCV used in the pediatric NIP.

Results: We identified 4330 serotyped IPD cases in children <5 years old. PCV13 serotypes represented 38.7% of total IPD cases, including 61.8% in PCV10 countries and 27.6% in PCV13 countries, most commonly due to serotypes 3 and 19A (10.2% and 12.7%, respectively, among all countries). Although there was considerable variability across countries, in general, a high percentage of IPD cases was caused by the aggregate serotypes included in PCV15 and PCV20 beyond PCV10 and PCV13 (Figure 1). In PCV10 countries, PCV15 and PCV20 would cover an additional 41.3% and 53.3% of IPD beyond serotypes contained in PCV10, largely due to coverage of serotype 19A. In PCV13 countries, PCV15 and PCV20 would cover an additional 7.5% and 34.9% of IPD beyond serotypes contained in PCV13. The most common IPD serotypes covered by higher valency PCVs were 10A (5.1%), 8, and 12F (4.6% each).

Figure 1. Percentages of IPD cases caused by vaccine-specific serotypes (PCV serotype coverage) among countries with PCV10 and PCV13 use in children <5 years old

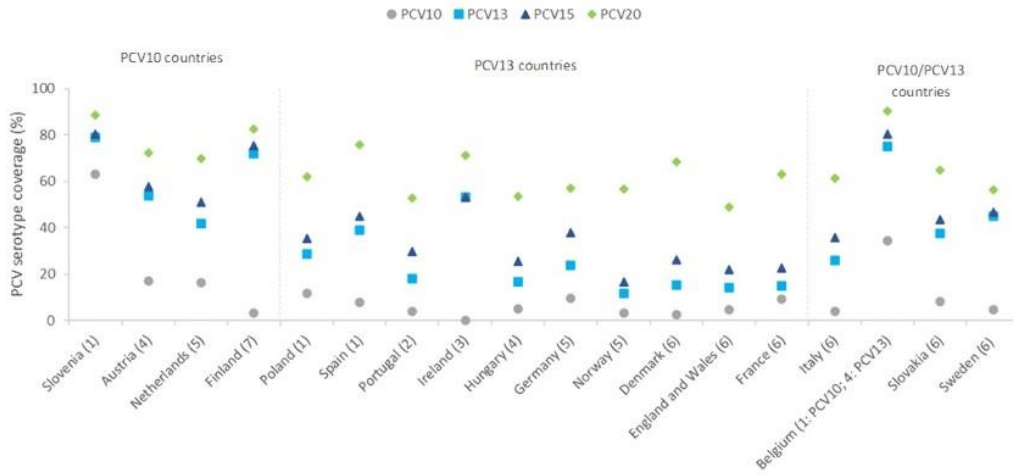

Abbreviations: PCV10: 10-valent pneumococcal conjugate vaccine (serotypes 1, 4, 5, 6B, 7F, 9V, 14, 18C, 19F, and 23F); PCV13: 13-valent pneumococcal conjugate vaccine (serotypes covered by PCV10 plus 6A, and 3 and 19A); PCV15: 15-valent pneumococcal conjugate vaccine (serotypes covered by PCV13 plus 22F and 33F); PCV20: 20-valent pneumococcal conjugate vaccine (serotypes covered by PCV15 plus 8, 10A, 11A, 12F, and 15B). Potentially cross-reacting serotype 6C was included in PCV formulations containing a conjugate for 6A. Similarly, potentially cross-reacting serotype 15C was included in PCV formulations containing a conjugate for 15B.

Note: Countries are ordered by type and duration of PCV use in the NIP. The number in parentheses is the duration of PCV use in the NIP based on the number of years difference between the year of PCV introduction and the first year of the data reporting period.

Conclusions/Learning Points: Among children in Europe, much of the remaining IPD burden is due to serotypes included in PCV15 and PCV20. The inclusion of these next generation PCVs into existing pediatric NIPs may further reduce the incidence of childhood IPD.

DISTRIBUTION OF NEISSERIA MENINGITIDIS SEROGROUP B VACCINE ANTIGENS IN MENINGOCOCCAL DISEASE CAUSING ISOLATES: A SYSTEMATIC REVIEW AND META-ANALYSIS OF THE LITERATURE, 2000-2021.

E-Posters

POSTER DISCUSSION SESSION 08: VACCINE II

Marios Detsis¹, Irimi Zografaki¹, Cristina Mendez²

¹Pfizer Hellas, Vaccines Department, Athens, Greece, ²Pfizer Spain, Vaccines Department, Madrid, Spain

Backgrounds: Serogroup B meningococcus is a major cause of Invasive Meningococcal Disease (IMD) in Europe. Two *Neisseria meningitidis* serogroup B vaccines are licensed in Europe and both include factor H binding protein (fHbp). 4C-MenB contains a nonlipidated fHbp from subfamily B in addition to Neisserial Heparin Binding Antigen (NHBA), Neisserial adhesin A (NadA), and outer membrane vesicles, whereas MenB-fHbp contains a lipidated fHbp from each one of the immunologically distinct subfamilies (A and B). Potential coverage of these vaccines is dependent on antigen sequence and antigen expression. The aim of this systematic review is to record all available evidence related to the prevalence and genetic variability of each of the four antigens (NHBA, fHbp, NadA, PorA) in circulating invasive MenB isolates worldwide.

Methods: Systematic review and meta-analysis of studies containing information about the prevalence and variability of the four antigens in Pubmed and Scopus from 2000 up to May 2021.

Results: Among the 1896 publications, 54 studies with 10,491 specimens from patients of all ages were included in analysis. The metanalysis of the prevalence of MenB vaccine antigenic variants is presented in Table 1. A complete coding fHbp gene was detected in 98% of isolates, 36% subfamily A and 62% subfamily B. The NadA gene was detected in 25% of all isolates. NHBA peptides considered as 4CMenB covered by gMATS were harboured by 50% of the isolates. The proportion of isolates containing the PorA VR2=4 variant, considered covered by 4CMenB, was 16%.

| | Number of studies | Total number of isolates | Overall proportion % (95%CI) | I ² |
|---|-------------------|--------------------------|------------------------------|-------------------------------|
| fHbp subfamily A | 27 | 6613 | 36% (31-41%) | I ² =95.3%, p<0.01 |
| fHbp subfamily B | 27 | 6613 | 62% (57-67%) | I ² =94.5%, p<0.01 |
| NHBA peptides 1, 2, 3, 5, 10, 20, 21, 113, 243 considered "covered" by 4CMenB (gMATS) | 20 | 4279 | 50% (41-59%) | I ² =97.3%, p<0.01 |
| NadA | 17 | 3066 | 25% (16-33%) | I ² =97.4%, p<0.01 |
| PorA VR2=4 (considered covered by 4CMenB) | 41 | 5764 | 16% (13-18%) | I ² =93.3%, p<0.01 |

Conclusions/Learning Points: Given the high antigen variability of invasive MenB isolates worldwide, vaccine selection and evaluation of vaccination programs should be continuously informed by genomic surveillance data.

PD127 / #1244

EVOLUTION OF PERTUSSIS AND INFLUENZA VACCINATION COVERAGE DURING PREGNANCY IN FLANDERS, BELGIUM OVER A 4-YEAR PERIOD: A TRUE SUCCESS STORY

E-Posters

POSTER DISCUSSION SESSION 08: VACCINE II

Kirsten Maertens¹, Mathieu Roelants², Cécile Guérin², Marlou De Kroon², Corinne Vandermeulen², Pierre Van Damme¹, Laura Willen¹

¹University of Antwerp, Centre For The Evaluation Of Vaccination, Vaccine & Infectious Diseases Institute, Antwerp, Belgium, ²KU Leuven, Department Of Public Health And Primary Care, Leuven, Belgium

Backgrounds: In Flanders, Belgium, vaccination coverage is assessed every 4 years. Coverage of pertussis and influenza vaccination during pregnancy is included in the survey since 2016. Evaluating two successive studies provides the opportunity to capture trends in vaccination coverage during pregnancy in Flanders, Belgium over the years.

Methods: A two-staged randomized cluster sample of woman who recently gave birth was recruited in two subsequent studies conducted in Flanders, Belgium using the EPI-method as proposed by the WHO. After informed consent, the mother was interviewed at home or through video call (only in 2021 due to pandemic measures). Collected data included socio-demographic characteristics and information on pertussis and influenza vaccination history, either documented or by recall. Vaccination information was completed using the electronic Flemish vaccination registry and medical records. Additionally, women were asked whether they would accept to be vaccinated with a COVID-19 vaccine if they were offered one.

Results: A 15% increase in both pertussis and influenza vaccination coverage was observed in pregnant women in Flanders, Belgium since 2016. Predictors for non-vaccination against pertussis and influenza vaccination during pregnancy were consistent in both surveys (Table). No negative impact of the COVID-19 pandemic on vaccination coverage during pregnancy was observed. Also, more than 70% of women indicated to accept COVID-19 vaccination if the vaccine is offered.

| Table: Coverage of pertussis and influenza vaccination during pregnancy and predictors for non-vaccination | | |
|---|---|--|
| | COHORT 1 (2016 EPI survey) | COHORT 2 (2021 EPI survey) |
| n | 481 | 612 |
| Year of delivery | 2016 | 2020-2021 |
| Pertussis vaccination policy | Recommended between 24-32 weeks GA; free-of-charge | Recommended between 24-32 weeks GA but can be administered from 16 weeks GA onwards; free-of-charge |
| Influenza vaccination policy | Recommended in second and third trimester of pregnancy; partially reimbursed | Recommended in all trimester of pregnancy; partially reimbursed |
| Pertussis vaccination coverage (%) | 69.3 | 85.0 |
| Influenza vaccination coverage (%) | 47.2 | 62.3 |
| Predictors for non-vaccination pertussis ^a | Low income, multiparity, hospital with >800 deliveries per year | Low income, multiparity, no planned daycare in first year of life, no medical follow-up of pregnancy, living in urban area |
| Predictors for non-vaccination influenza ^a | Multiparity, educational level (secondary school versus master degree), delivery and pregnancy follow-up outside of Flanders, no medical follow-up of pregnancy | Educational level (secondary school versus master degree), country of birth mother (other EU-country versus Belgium), unemployment, delivery at home |

^a significant in multivariate analysis

Conclusions/Learning Points: The coverage of both pertussis and influenza vaccination during pregnancy in Flanders, Belgium increased substantially over time. Improvement is still possible by targeting the underserved populations like pregnant women with a lower socio-economic background, and by increasing knowledge and awareness in target groups.

ROTAVIRUS EPIDEMIOLOGY AND GENOTYPE DISTRIBUTION: A 12-YEAR GREEK NATIONAL MULTICENTER STUDY

E-Posters

POSTER DISCUSSION SESSION 08: VACCINE II

Dimitra Maria Koukou¹, Athanasios Michos¹, Panagiota Chatzichristou¹, George Trimis², Elizabeth-Barbara Tatsi¹, Charilaos Dellis¹, Levantia Zachariadou³, Theodota Liakopoulou⁴, Vassiliki Syriopoulou¹
¹"Aghia Sophia" Children's Hospital, Division Of Infectious Diseases, First Department Of Pediatrics, Medical School, National And Kapodistrian University Of Athens, Athens, Greece, Athens, Greece, ²MSD, 2. medical And Scientific Affairs, Athens, Greece, ³"Aghia Sophia" Children's Hospital, Department Of Microbiology, Athens, Greece, ⁴Iaso Children's Hospital, Department Of Pediatrics, Athens, Greece

Backgrounds: Two Rotavirus (RV) vaccines (RV5 and RV1) were licensed in Greece in 2007 and were included in the National Immunization Program (NIP) with partial reimbursement since 2012. The aim of the study was to present the epidemiology of RV gastroenteritis (RVGE) in children during the post-vaccination period in Greece.

Methods: In this 12-year prospective multicenter nationwide study, children ≤16 years old with RVGE were recruited. Epidemiological and molecular genotyping analyses were performed during 09/2008-08/2020 and data were compared between the early (2008-2012) and late (2012-2020) post-vaccination period, based on the year of introduction of RV vaccines into the NIP.

Results: Study's population was children with RVGE (n=3874) with median age of 1.4 years (IQR;0.5-3.3). Most infections were identified in children 0-3 years old (72.2%) with males representing 55.6%. The majority of infections were detected from December-May timeframe (69.1%). The 6 common RV genotypes (G1P[8], G2P[4], G3P[8], G4P[8], G9P[8], G12P[8]) were found in 92.2% of children. Their frequencies were G4P[8];44.1%, G1P[8];25.4%, G2P[4];14.9%, G9P[8];3.5%, G12P[8];2.2%, G3P[8];2.1%. Genotypes with uncommon G/P combinations (unusual) and more than one G or/and P types (mixed) were detected in 4.3% and 3.5% of children respectively. At least one G or P common type was found in 99.9% of the genotyped samples. During the late post-vaccination period, RV seasonal peak was detected earlier in the winter, median age of infected children was higher and G9P[8], unusual and mixed genotypes were detected more often (P-value<0.001).

Conclusions/Learning Points: Most Greek children with RV infection were 0-3 years old and were detected during winter and spring. G4P[8] and G1P[8] were the commonest circulating genotypes. Although unusual and mixed genotypes were detected sporadically, there was no evidence of their predominance or substitution of the common genotypes.

COST-EFFECTIVENESS ANALYSIS OF CELL DERIVED VERSUS EGG-DERIVED SEASONAL INFLUENZA VACCINATION IN CHILDREN AND ADULT POPULATION IN ARGENTINA

E-Posters

POSTER DISCUSSION SESSION 08: VACCINE II

Analia Uruena¹, Paula Micone², Cecilia Magneres³, MCGovern Ian⁴, Joaquin Mould-Quevedo⁴, Tadeu Rocha-Sarmiento⁵, Norberto Giglio⁶

¹Salud University, Cepycet, Buenos Aires, Argentina, ²Hospital Carlos G Durand, Gynecology Department, Buenos Aires, Argentina, ³Seqirus S.A, Medical Affairs, Buenos Aires, Argentina, ⁴Seqirus USA Inc, Medical Affairs, New Jersey, United States of America, ⁵Kantar, Health Division, São Paulo, Brazil, ⁶Hospital de Niños Ricardo Gutierrez, Epidemiology Department, Buenos Aires, Argentina

Backgrounds: Propagation of influenza vaccine viruses in chicken eggs can result in egg-adaptive mutations, potentially reducing vaccine effectiveness (VE). Cell-derived influenza vaccines avoid egg-adaptive changes, potentially improving VE. We assessed the cost-effectiveness of cell-derived quadrivalent influenza vaccine (QIVc) versus egg-derived quadrivalent influenza vaccine (QIVe) in children and adults, the recommended target populations in Argentina from payer's and societal perspective.

Methods: We developed an age-stratified static model comparing estimated costs and health benefits of vaccination using a one-year time horizon. Argentinean influenza burden of disease data from 2014-2019 was used to determine the average incidence and proportion of influenza A and B cases, and B strains lineage mismatch frequency. The relative VE (rVE) of QIVc vs QIVe was assumed to be 8.1% for children and 11.4% for adults. An alternative high egg-adaptation scenario was also assessed. Healthcare resource use, utility and unit costs model inputs were sourced from Argentinean or international literature. Costs were expressed in 2021 U.S. dollars. Deterministic and probabilistic sensitivity analyses were performed.

Results: Compared to QIVe, QIVc would prevent 17,857 influenza cases, 2,418 outpatient visits, 316 hospitalizations and 12 deaths. The incremental cost-effectiveness ratio (ICER) per QALY in the base case was US\$12,214 and QIVc resulted dominant, from the payer's and the societal perspective, respectively; while in the high egg-adaptation scenario was US\$2,311 from the payer's perspective and QIVc resulted dominant from societal perspective. Deterministic sensitivity analyses showed that QIVc and QIVe acquisition costs, QIVc rVE and influenza incidence were the main drivers of the ICER.

Conclusions/Learning Points: QIVc in Argentina would be cost-effective relative to QIVe. The potential health benefits and savings with QIVc would be even higher within influenza seasons where egg-adaptation issues predominate.

PD130 / #1421

RATIONALE FOR A PENTAVALENT MENINGOCOCCAL SEROGROUP ABCWY VACCINE IN EUROPE : A REVIEW OF EPIDEMIOLOGIC AND CLINICAL DATA

E-Posters

POSTER DISCUSSION SESSION 08: VACCINE II

Paula Peyrani¹, Cindy Burman¹, Johannes Beeslaar², John Perez¹, Paul Balmer¹

¹Pfizer Inc, Vaccine Medical And Scientific Affairs, Collegetown, United States of America, ²Pfizer Inc, Vaccine Clinical Research And Development, Hurley, United Kingdom

Backgrounds: Invasive meningococcal disease (IMD) epidemiology while unpredictable, is dominated by 5 serogroups (A,B,C,W,Y). A single vaccine targeting all 5 serogroups could enhance protection against IMD.

Methods: Relevant information from government and manufacturer resources were used to assess European IMD burden, vaccination recommendations, and clinical data supporting a MenABCWY vaccine.

Results: In 2018, IMD incidence in Europe was 0.62/100,000. The highest incidence was in infants (8.34/100,000), with additional peaks in young children (2.38/100,000) and adolescents/young adults (0.94/100,000). Serogroup B, C, W, or Y accounted for 96% of cases. Notably, a rise in hypervirulent MenW cases has been observed. Three MenACWY conjugate and 2 MenB vaccines are licensed in Europe; vaccine recommendations and schedules vary significantly by country and age group. A MenABCWY vaccine, comprised of 2 licensed vaccines (MenACWY-TT; MenB-FHbp) in a single formulation, is being evaluated in an active-controlled study in 1610 healthy 10–25-year-olds (NCT03135834). MenACWY-naïve or MenACWY-experienced participants were randomized to receive MenABCWY (Months 0,6) or MenB-FHbp (Months 0,6) and MenACWY-CRM (Month 0). Protective hSBA titres were observed in 84.3%–98.6% of individuals against 4 MenB strains ($\geq 1:8$ for A55/B24/B44; $\geq 1:16$ for A22) following 2 doses of MenABCWY. For MenACWY, 100% of MenACWY-naïve and $\geq 99.5\%$ for MenACWY-experienced individuals following 2 doses of MenABCWY had protective titres $\geq 1:8$ (Figure). Non-inferior hSBA responses induced by MenABCWY versus MenB-FHbp/MenACWY-CRM were observed for both MenB and MenACWY across all groups. Reactogenicity events postvaccination were similar in frequency across

Figure. Percentages of participants in each group achieving hSBA titres $\geq 1:8^*$

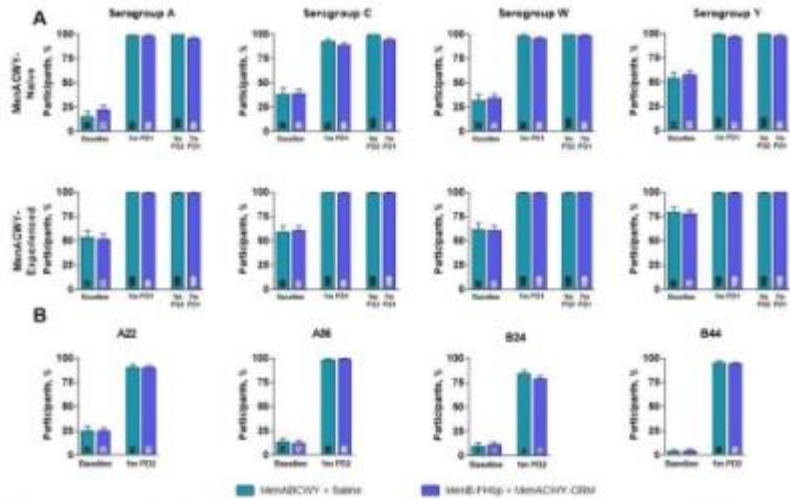

(A) Shows percentages of participants with hSBA titres $\geq 1:8$ for serogroups A, C, W, and Y, with groups separated by MenACWY experience and (B) shows percentages of participants with hSBA titres $\geq 1:8$ against MenB strains A56, B24, and B44. *Strain A22 only, shows percentages of participants with hSBA titres $\geq 1:16$. Participants receiving MenACWY + saline and receiving MenB-FHlg + MenACWY-CRM were combined without regard to MenACWY experience. LLOs were 1:16 for the A22 strain and 1:8 for other strains. 1m=1 month, 7m=7 months, hSBA=serum bactericidal activity assay using human complement, LLO=lower limit of quantitation, PD=positive.

groups.

Conclusions/Learning Points: Evolving epidemiology and differing recommendations for MenB and MenACWY vaccines present considerable challenges. A well-tolerated vaccine covering all 5 serogroups which demonstrates noninferior immune responses to individual licensed vaccines offers the potential to simplify protection against meningococcal disease in Europe. Funding: Pfizer

PD131 / #1503

DEVELOPMENT OF A MODEL TO ESTIMATE PERSISTENCE OF HSBA TITERS OVER TIME FOLLOWING A PRIMARY SERIES AND BOOSTER DOSE OF MENB-FHBP

E-Posters

POSTER DISCUSSION SESSION 08: VACCINE II

Bing Cai¹, Paula Peyrani¹, Johannes Beeslaar², Cindy Burman¹, John Perez¹, Paul Balmer¹
¹Pfizer Inc, Vaccine Medical And Scientific Affairs, Collegeville, United States of America, ²Pfizer Inc, Vaccine Clinical Research And Development, Hurley, United Kingdom

Backgrounds: The MenB-FHbp vaccine is licensed for individuals ≥ 10 years old for protection against MenB disease. Immunopersistence of hSBA titers against 4 vaccine-heterologous test strains ≤ 4 years after a 2-dose MenB-FHbp primary series and ≤ 26 months after a booster dose administered 4 years post-primary has been reported. Persistence of hSBA titers 5 years after a MenB-FHbp primary series and booster dose was estimated using a power law model (PLM).

Methods: We fitted the PLM with hSBA data from previous MenB-FHbp phase 2/3 clinical studies assessing a 2-dose primary regimen (Months 0,6), and immunopersistence and booster dosing 4 years post-primary in healthy adolescents (NCT01299480, NCT01543087). The model was then used to predict hSBA titers and 95% confidence intervals against 4 primary test strains 5 years post-primary and 5 years post-booster administered 4 years after the primary series.

Results: The PLM-predicted hSBA titers were consistent with those observed following a 0, 6 month MenB-FHbp primary series and a booster dose 4 years later (Figure). At 5 years after the primary series, the percentage of individuals with hSBA titers $\geq 1:8$ (1:16 for A22 strain) was predicted by the PLM to range from 15.0%–49.7%. Five years following a booster dose at 4 years, the PLM predicted that 50.0%–69.8% of individuals had hSBA titers $\geq 1:8$ or

Figure. Observed and predicted immunopersistence of hSBA titers after (A) 2-dose primary and (B) booster dose of MenB-FHbp

A.

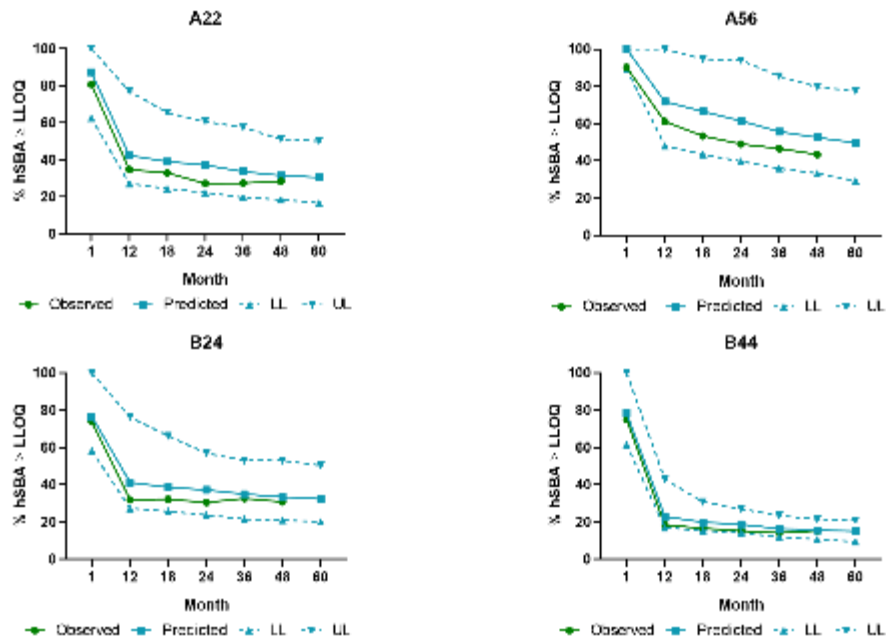

B.

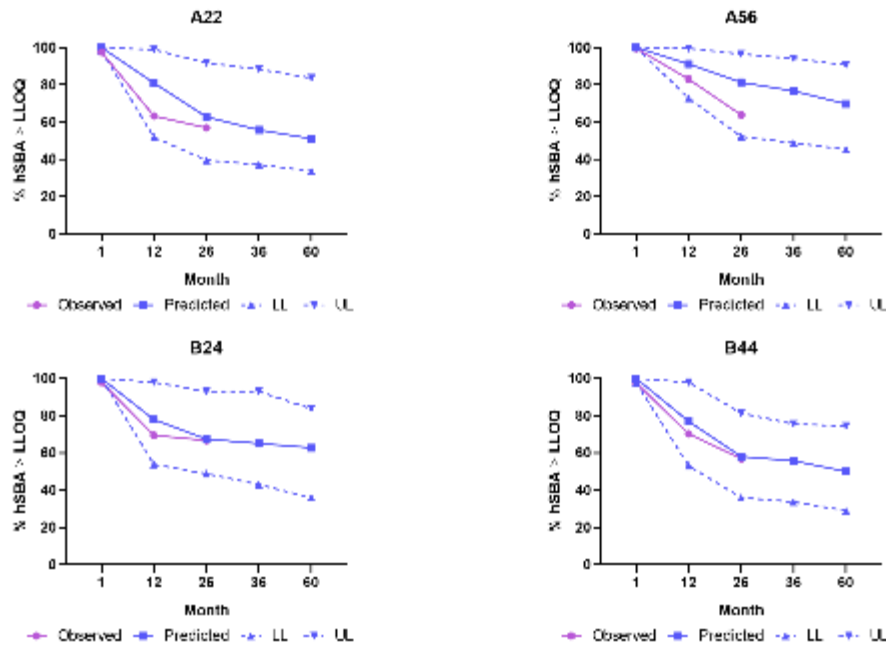

Data are the percentage of participants for the 4 test strains. hSBA=serum bactericidal antibody using human complement; LL=lower limit; UL=upper limit.

1:16.

Conclusions/Learning Points: The PLM supports that the persistence of antibody responses post-primary MenB-FHbp vaccination are maintained to at least 5 years. At 5 years post-booster, a substantial percentage of adolescents/young adults is predicted to have protective hSBA titers against diverse disease-causing strains. Funding: Pfizer

PD132 / #1816

COMPARING SEROTYPE 19A INVASIVE PNEUMOCOCCAL DISEASE EPIDEMIOLOGY IN NEW ZEALAND AND AUSTRALIA – DOES THE CHOICE OF PNEUMOCOCCAL CONJUGATE VACCINE 10 OR 13 MAKE A DIFFERENCE?

E-Posters

POSTER DISCUSSION SESSION 08: VACCINE II

Nienke Hagedoorn¹, Andy Anglemyer^{2,3}, Mica Hartley⁴, Tony Walls¹

¹University of Otago, Pediatrics, Christchurch, New Zealand, ²Institute of Environmental Science and Research, Health Intelligence Team, Wellington, New Zealand, ³University of Otago, 3. department Of Preventive And Social Medicine, Dunedin, New Zealand, ⁴Australian Government Department of Health, Communicable Diseases And Surveillance Section, Canberra, Australia

Backgrounds: Both the 10-valent pneumococcal conjugate vaccine (PCV10) and the 13-valent PCV (PCV13) have shown to decrease invasive pneumococcal disease (IPD) in children. The Australian infant immunisation schedule uses PCV13, while New Zealand (NZ) switched from PCV13 to PCV10 in 2017. In NZ, cases of serotype 19A (not included in PCV10) have been increasing since 2017. In this study we compare IPD and serotype 19A incidence between Australia and NZ in 2017-2021.

Methods:: We collated IPD notification data from national surveillance systems in NZ and Australia from 2017 to 2021 and merged with census data. IPD was defined as detection of *S. pneumoniae* from a sterile site. In children <2 years, we assessed trends in IPD incidence with a focus on 19A.

Results: Between 2017-2020, IPD rates did not differ between Australia and NZ (Figure 1A). In 2021, however, the IPD rate in NZ (37.4; 95% CI 27.3-50.0) was higher than in Australia (24.7; 95% CI 20.9-29.0) ($p=0.02$). Since 2019 the proportion of isolates that are 19A has been higher in NZ compared to Australia ($p<0.001$). In fact, the proportion of isolates that are 19A has increased from 6.9% in 2018 to 36% in 2021 in NZ, whereas in Australia it has remained <10% (Figure 1B). In NZ, more than 70% of 19A cases <2 years in 2020-2021 were among Pacific peoples and Māori children (~35% of the <2 population), of whom only 2 were unvaccinated.

Figure 1: (A) IPD rate and 95%CI per 100,000 for Australia and New Zealand in children <2 years, (B) Proportion of serotype 19A in IPD cases for Australia and New Zealand in children <2 years

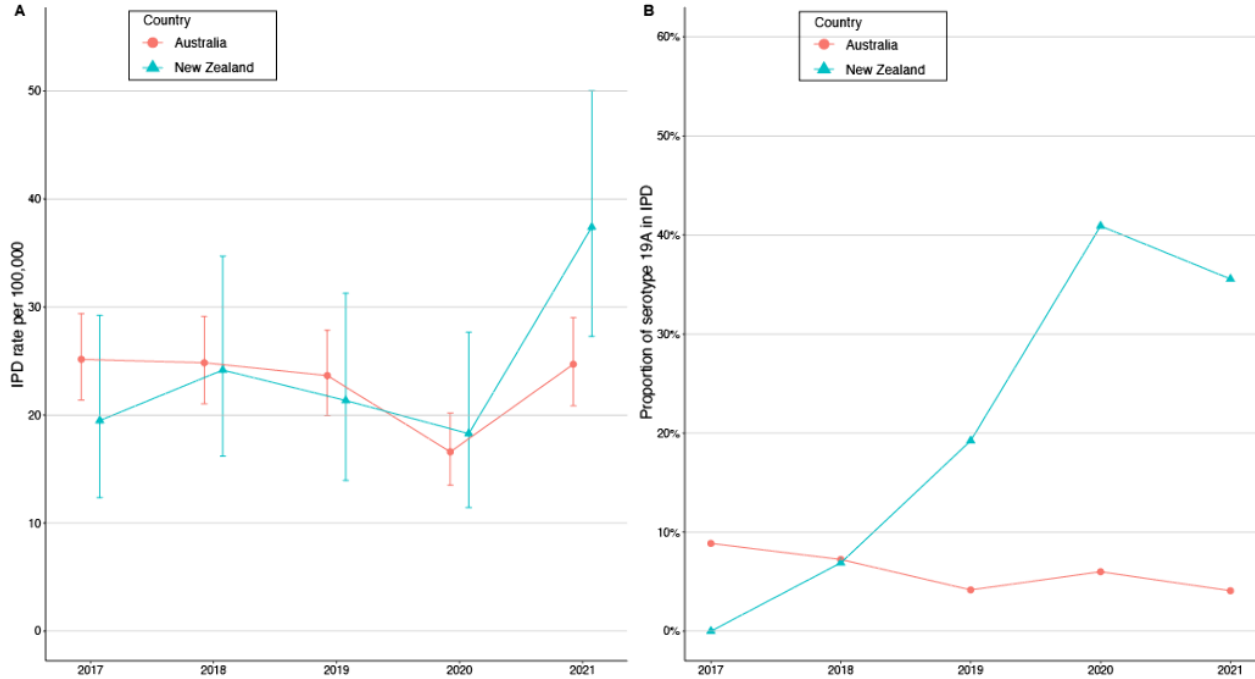

Conclusions/Learning Points: Overall IPD incidence in young infants was higher in NZ compared to Australia in 2021. Both the numbers and proportions of IPD due to 19A are increasing in NZ children <2 years of age. This suggests that a switch to PCV13 in NZ should be considered.

MEASLES AND RUBELLA SEROPREVALENCE IN PREGNANT WOMEN DURING THE LAST MEASLES EPIDEMIC IN GREECE

E-Posters

POSTER DISCUSSION SESSION 08: VACCINE II

Stayroula Papailiou¹, Alexandra Soldatou¹, Antonios Marmarinos², Margaritis Avgeris², Evangelia Papathoma³, Michael Sindos⁴, Sofia Georgantzi⁴, Alexandros Rodolakis⁴, Nicoletta Iacovidou⁵, Dimitrios Gourgiotis², Maria Tsolia¹

¹School of Medicine, National and Kapodistrian University of Athens, Second Department Of Paediatrics, 'p. & A. Kyriakou' Children's Hospital, Athens, Greece, ²School of Medicine, National and Kapodistrian University of Athens, Laboratory Of Clinical Biochemistry-molecular Diagnostics, Second Department Of Paediatrics, 'p. & A. Kyriakou' Children's Hospital, Athens, Greece, ³'Alexandra' University and State Maternity Hospital, Neonatal Intensive Care Unit, Athens, Greece, ⁴School of Medicine, National and Kapodistrian University of Athens, First Department Of Obstetrics And Gynaecology, 'alexandra' University And State Maternity Hospital, Athens, Greece, ⁵School of Medicine, National and Kapodistrian University of Athens, Neonatal Department, 'aretaieio' Hospital, Athens, Greece

Backgrounds: Measles infection in pregnancy leads to serious complications while rubella is associated with devastating effects to the fetus. Seroprevalence studies are useful tools for the estimation of herd immunity in a population and the implementation or improvement of immunization strategies. We assessed the seroprevalence and antibody levels against measles and rubella in pregnant women during the last measles epidemic in Greece and the potential effect of different demographic factors in them.

Methods:: We conducted a cross-sectional study in two maternity hospitals in 2017-2019. Blood samples were taken prior to delivery and anti-measles and anti-rubella IgG antibodies were measured by ELISA. Seroprevalence and antibody levels were examined according to maternal age, country of origin, educational level and number of children in household.

Results: Overall, 248 serum samples and paired questionnaires were analysed. Median maternal age was 33 years. 220 (87%) and 206 (81%) mothers were seropositive against measles (>200 IU/ml) and rubella (>20 IU/ml), respectively. Increasing age was associated with higher seropositivity ($p=0.012$) and antibody titres ($p=0.004$) for rubella only. Women born outside Greece had higher antibody titres against rubella ($p=0.002$).

Conclusions/Learning Points: To our knowledge, this is the first Greek study which provides data about seroprevalence of measles and rubella in pregnancy. We identified a significant proportion of pregnant women with inadequate protection against measles and rubella. Identifying gaps in immunity in the general population and specific high-risk subgroups is an important aspect of the global effort to eliminate these two vaccine preventable diseases. Promotion of childhood and catch-up immunization, especially in high-risk groups, must be intensified.

AETIOLOGY OF YOUNG INFANT BLOODSTREAM INFECTIONS IN KAMPALA, UGANDA.

E-Posters

POSTER DISCUSSION SESSION 09: BIOMARKERS & SEPSIS

Hannah Davies¹, Hannington Tasimwa², Lauren Hookham³, Mary Kyohere⁴, Valerie Tusubira⁵, Lydia Nakibuuka⁴, Alexander Amone⁴, Amusa Wamawobe², Ruth Olema⁴, Pooja Ravji³, Melanie Etti¹, Musa Sekikubo⁶, Philippa Musoke⁴, Kirsty Le Doare¹

¹St George's University of London, Institute Of Infection & Immunity, London, Uganda, ²Makerere School of Medicine, Department Of Medical Microbiology, Kampala, Uganda, ³St George's, University of London, Infection & Immunity, London, United Kingdom, ⁴Makerere University John Hopkins Research Collaboration, Medical Research, Kampala, Uganda, ⁵Makerere University John Hopkins Research Collaboration, Data Management, Kampala, Uganda, ⁶Makerere University John Hopkins Research Collaboration, Department Of Obstetrics & Gynaecology, Kampala, Uganda

Backgrounds: The first months of a child's life are the most vulnerable, 47% of all under-five deaths occur in the first 28 days of life, 11% of these are caused by infections. The World Health Organization recommends ampicillin and gentamicin as first line antibiotics for neonatal sepsis and ceftriaxone as second-line, however, increasing levels of antimicrobial resistance have been demonstrated.

Methods: A surveillance study for neonatal bloodstream infections was conducted at two hospital sites in Kampala, Uganda between April 2019, and December 2020. Infants 0-90 days of life admitted to neonatal or paediatric wards with signs of sepsis had a blood culture collected. Data was collected on baseline characteristics including age at admission, sex, signs and symptoms at admission and HIV exposure. Information on outcomes was documented where available from the hospital files or admission books.

Results: A total of 7323 blood cultures were collected, 72% were collected prior to administration of antibiotics. 805 cultures were positive with 812 organisms identified. Of the pathogenic organisms, Enterococcus (3.9%), Group B Streptococcus (3.6%), Escherichia coli (3.6%) Streptococcus viridans (3.0%) and Acinetobacter baumannii (2.8%) were the commonest. 61.5% of organisms were resistant to the World Health Organization first line antibiotic ampicillin, 43.8% to gentamicin and 42.4% to ceftriaxone. The case fatality rate for infants with a positive blood culture with at least one pathogenic organism was 18.3%.

Conclusions/Learning Points: We have demonstrated the aetiology of young infant bloodstream infections across two Ugandan sites in Kampala. High levels of antimicrobial resistance to recommended empirical antibiotic regimens are concerning and warrant further investigation.

PD135 / #1376

DIAGNOSTIC ACCURACY OF BIOMARKER TESTING IN EARLY ONSET NEONATAL SEPSIS: A SYSTEMATIC REVIEW AND META-ANALYSIS

E-Posters

POSTER DISCUSSION SESSION 09: BIOMARKERS & SEPSIS

Lisanne Van Leeuwen¹, Elandri Fourie², Gerrie Van Den Brink², Vincent Bekker¹, Marlies A. Van Houten²
¹Leiden University Medical Center, Pediatrics, Leiden, Netherlands, ²Spaarne Gasthuis, Science Institute Vaccine, Infection And Immunology, Hoofddorp, Netherlands

Backgrounds: In the Netherlands, over 10.000 newborns per year receive intravenous antibiotics for a suspected bacterial infection in the first week of life, but only a minority of these infants experience a proven or probable infection. A biomarker test could potentially be useful in differentiating between newborns with and without an infection and could improve antibiotic decision-making. Several biomarkers have been tested, but were never systematically compared in their accuracy to diagnose or rule out an early onset sepsis (EOS). Here we aim to identify the most promising biomarker in maternal samples, umbilical cord blood and neonatal blood samples.

Methods: Several databases were searched until September 2021. Studies describing EOS within the first week of life and the diagnostic accuracy of at least one biomarker were selected. A positive blood culture was considered as gold standard. Three independent investigators extracted and analysed the data. Quality was assessed using QUADAS-2.

Results: A total of 314 studies addressed at least one biomarker, 20 individual biomarkers were studied in maternal samples, 40 in umbilical cord blood and 64 different biomarkers were tested in neonatal blood. In all sample types C-reactive protein, procalcitonin and interleukin-6 and -8 were studied most frequently, but results showed a wide range in sensitivity and specificity. Presepsin and serum amyloid A were studied less often, but diagnostic accuracy appears to be much higher.

Conclusions/Learning Points: Despite extensive research, no perfect biomarker for EOS has been identified to date. Variation in case definition and cut-off values makes a direct comparison challenging. Overall, a biomarker stand-alone test is not reliable to direct antibiotic decision-making. Future research should focus on the combination of biomarkers with clinical characteristics.

CHARACTERISTICS OF SERRATIA MARCESCENS BACTEREMIA IN A TERTIARY CHILDREN'S MEDICAL CENTER

E-Posters

POSTER DISCUSSION SESSION 09: BIOMARKERS & SEPSIS

Eliana Fanous¹, Ofer Schiller², Eytan Kaplan³, Yoav Vardi⁴, Tina Herscovici⁵, Haim Ben-Zvi⁶, Meirav Mor⁷, Gilat Livni¹

¹Schneider Children's Medical Center in Israel, Department Of Pediatrics A, Petah-Tikva, Israel, ²Schneider Children's Medical Center in Israel, Pediatric Cardiac Intensive Care Unit, Petah- Tikva, Israel, ³Schneider Children's Medical Center in Israel, Pediatric Intensive Care Unit, Petah-Tikva, Israel, ⁴Schneider Children's Medical Center in Israel, Department Of Pediatrics B, Petah-Tikva, Israel, ⁵Schneider Children's Medical Center in Israel, Neonatal Intensive Care Unit, Petah-Tikva, Israel, ⁶Beilinson Hospital, Microbiology Laboratory, Petah-Tikva, Israel, ⁷Schneider Children's Medical Center in Israel, Emergency Department, Petah-Tikva, Israel

Backgrounds: The frequency of Serratia bloodstream infections (BSI) has been rising amongst children; however, data regarding risk factors for bacteremia; and epidemiologic, laboratory, and clinical characteristics are lacking.

Methods: This retrospective study was conducted in a university affiliated, tertiary children's hospital. The microbiology database was queried for Serratia marcescens positive blood cultures, between January 2007 and May 2020. Patients' demographic, clinical, and microbial characteristics were collected and analyzed.

Results: Eighty-five patients were identified; medical files were accessible for 81. Of these, 65 (80%) were hospitalized in intensive care units. The median age was 78 days, range: 4 days to 16.5 years. In-hospitalisation mortality was 26%. Thirteen (62%) patients who died were under 90 days old. Underlying conditions including prematurity, congenital cardiac defects, chronic illnesses, and malignancies were detected in 77/81 (95%). Prior to BSI, 50 (62%) patients underwent interventional procedures. Thrombocytopenia (median platelet count 94,500, range 4,000 – 632,000/ μ L) and elevated C-reactive protein levels (median 12.5, range 0 - 31 mg/dL) were found in 49 (60%) children. The most common empiric treatment regimen included piperacillin/tazobactam (62%). Twenty-eight children received either piperacillin/tazobactam or cephalosporin in monotherapy as final treatment. Survival rates were the same for the two regimens (85%).

Conclusions/Learning Points: Risk factors found for Serratia BSI include prematurity, congenital heart disease, chronic disease, central lines, and respiratory support following surgical interventions. Mortality was associated ($p < 0.05$) with hospitalization in intensive care units and thrombocytopenia (platelet count below 150,000/ μ L). Survival was similar following treatment with a third-generation cephalosporin and with piperacillin-tazobactam.

BRIDGING THE DIAGNOSTIC KAWASAKI DISEASE GENE EXPRESSION PROFILING CLASSIFIER FROM MICROARRAY TO A CLINICALLY APPLICABLE MULTIPLEX QRT-PCR ASSAY (KIDS-GEP)

E-Posters

POSTER DISCUSSION SESSION 09: BIOMARKERS & SEPSIS

Rowan Kuiper¹, Victoria Wright², Chisato Shimizu³, Daphne Huigh⁴, Myrsini Kaforou², Adriana Tremoulet³, Daniëlle Van Keulen⁵, Jethro Herberg², Clive Hoggart^{2,6}, Dominic Habgood-Coote², Jesus Rodriguez-Manzano², Dennie Tempel⁷, Jane Burns³, Michael Levin²

¹SkylineDx, Bioinformatics Department, Rotterdam, Netherlands, ²Imperial College London, Department Of Infectious Disease, London, United Kingdom, ³Rady Children's Hospital and University of California San Diego, Department Of Pediatrics, San Diego, United States of America, ⁴SkylineDx, Laboratory Department, Rotterdam, Netherlands, ⁵SkylineDx, Science Department, Rotterdam, Netherlands, ⁶Icahn School of Medicine at Mount Sinai, Department Of Genetics And Genomic Sciences, New York City, United States of America, ⁷SkylineDx, Product Development Department, Rotterdam, Netherlands

Backgrounds: Kawasaki disease (KD) is a systemic vasculitis that is most prevalent in children under 5 years of age and can result in the development of coronary artery abnormalities (CAA). Early treatment with intravenous immunoglobulin is effective, but diagnosing KD can be challenging. Timely diagnosis of KD may become more straightforward with the recent discovery of a microarray-based host response classifier that discriminates KD patients from patients with other febrile conditions. As a microarray is not suited for the acute clinical care setting, we bridged this microarray-based classifier to a clinically applicable One-step multiplex qRT-PCR assay: the Kawasaki Disease Gene Expression Profiling (KiDs-GEP) classifier.

Methods: A qRT-PCR assay was designed and optimized, and subsequently applied to RNA isolated from whole blood samples of KD patients and febrile controls. The results were used to reweight the original classifier.

Results: The performance of the bridged KiDs-GEP classifier was comparable to the original classifier with a cross-validated area under the ROC curve (AUC) of 0.964 [95%CI: 0.924-1.00] vs 0.992 [95%CI: 0.978-1.00] respectively. Both classifiers demonstrated similar trends over various disease conditions, with the clearest distinction between individuals diagnosed with KD and viral infections.

Conclusions/Learning Points: In conclusion, we successfully bridged the microarray-based classifier into the qRT-PCR KiDs-GEP classifier: a more rapid and less costly assay that brings the host response clinical test for KD closer to the hospital clinical laboratory, enabling earlier diagnosis, treatment and better prevention against CAA.

A HOST-PROTEIN TEST BASED ON TRAIL, IP-10 AND CRP DIFFERENTIATES BETWEEN ADENOVIRAL AND BACTERIAL-ADENOVIRAL CO-INFECTIONS IN CHILDREN WITH POSITIVE PCR-ADENOVIRUS DETECTION

E-Posters

POSTER DISCUSSION SESSION 09: BIOMARKERS & SEPSIS

Michal Stein^{1,2,3}, Ellen Bamberger^{3,4}, Irina Chistyakov⁴, Daniel Dumov⁴, Isaac Srugo⁴, Renata Yakobov³, Louis Bont⁵, Adi Klein^{3,6}

¹Sheba Medical Center, Pediatrics, Ramat Gan, Israel, ²Hillel Yaffe, Infectious Diseases, Hadera, Israel, ³Technion Institute of Technology, Rappaport Faculty Of Medicine, Haifa, Israel, ⁴Bnai Zion, Pediatrics, Haifa, Israel, ⁵University Medical Centre Utrecht, Pediatric Infectious Diseases, Utrecht, Netherlands, ⁶Hillel Yaffe Medical Center, Pediatrics, Hadera, Israel

Backgrounds: Adenovirus is one of the major pathogens causing acute pediatric respiratory illness that often mimics bacterial infection, making it challenging to differentiate adenoviral infection from adenoviral-bacterial co-infection. A host-protein test that produces a bacterial likelihood score (BV score) for differentiating bacterial from viral infection integrates the expression levels of TNF-related apoptosis-induced ligand, interferon gamma-induced protein-10, and C-reactive protein. BV exhibited a negative predictive value (NPV) of 98% in prior studies. Here we evaluate BV score's performance in children with adenovirus PCR detection.

Methods: A retrospective analysis from two prospective cohort studies was performed on children aged 3 months to 20 years with adenovirus PCR positive infection. Reference standard infection etiology was adjudicated by independent experts based on clinical, laboratory, microbiological, and radiological data. The BV score ranges from 0 to 100 and provides three results: viral (0-34), equivocal (35-65) and bacterial (66-100). Experts were blinded to BV score results.

Results: Out of 1779 children, 142 had an adenovirus PCR positive nasopharyngeal swab. The median age of the cohort was 1.2 (IQR 1.2) years, 50.7% were male and 52.8% were hospitalized. 12 cases were adjudicated by the expert panel as bacterial, 115 as viral and 15 were indeterminate. The BV score attained sensitivity of 100.0% (95% CI 100.0%-100.0%) specificity of 89.5% (83.2%-95.8%), and NPV of 100.0% (92.6%-100.0%). The equivocal rate was 19.7%.

Conclusions/Learning Points: The BV score accurately differentiates between adenoviral and bacterial-adenoviral co-infection in children with PCR-positive adenovirus detection, supporting potential to improve appropriate antibiotic use in this population

AGE DISTRIBUTION IN PEDIATRIC COMMUNITY-ACQUIRED BLOODSTREAM INFECTIONS

E-Posters

POSTER DISCUSSION SESSION 09: BIOMARKERS & SEPSIS

Efrosyni Tsiampali, Eftychia Svarna, Georgia Gazeti, Eleni Papadimitriou, Eleftheria Chatzi, Anastasia Ntavoura, Dimitrios Pipilas, Anastasia Batsiou, Ioanna Grivea, George Syrogiannopoulos
 University of Thessaly, Department Of Pediatrics, Larissa, Greece

Backgrounds: The outcome of patients with bloodstream infections (BSI) depends on many parameters, including the etiologic agent and the age of the patient.

Methods: This is a study of BSI and the age- and pathogen-related rate in children hospitalized at the University General Hospital of Larissa, Greece during 2010-2020.

Results: During the 11-year study period, a total of 18,480 children were hospitalized. There were 130 children with a positive blood culture that indicated true bacteremia; median age 1.6 years (Interquartile range: 4 months - 6.25 years). Ninety-five children (73.1%) with bacteremia were aged under 6 years. There was a predominance of *Streptococcus agalactiae* and *Escherichia coli* in infants younger than 3 months (59.2% of cases), as well as of *Staphylococcus aureus* and *Brucella* spp. in children older than 5 years (68.5% of cases). Among children aged 3 months to 5 years, variability of etiologic agents was observed; *S. aureus*, *S. pneumoniae*, *S. pyogenes*, *Brucella* spp. and *E. coli* represented 55.9% of cases (Table 1). Table 1. Frequency of isolated pathogens according to the age group

| Pathogen | 0 - 2 months N=27 | 3 - 23 months N=41 | 2 - 5 years N=27 | ≥6 years N=35 |
|------------------------|----------------------|-----------------------|---------------------|------------------|
| <i>S. aureus</i> | 5 (18.5)* | 7 (17.1) | 4 (14.8) | 11 (31.4) |
| <i>Brucella</i> spp. | | 1 (2.4) | 5 (18.5) | 13 (37.1) |
| <i>E. coli</i> | 8 (29.6) | 5 (12.2) | 1 (3.7) | |
| <i>S. pneumoniae</i> | | 1 (2.4) | 7 (25.9) | 5 (14.3) |
| <i>S. agalactiae</i> | 8 (29.6) | 2 (5) | | |
| <i>S. pyogenes</i> | | 2 (5) | 5 (18.5) | 1 (2.9) |
| <i>N. meningitidis</i> | | 4 (9.7) | 1 (3.7) | 1 (2.9) |
| <i>K. pneumoniae</i> | 3 (11.1) | 3 (7.3) | | |
| Others | 3 (11.1) | 16 (39) | 4 (14.8) | 4 (11.4) |

*n (%)

Conclusions/Learning Points: The frequency of the isolated pathogens in bacteremia cases varied according to the age group. There was a notable variability of etiologic agents detected in children aged 3 months to 5 years. In contrast, among children younger than 3 months and older than 5 years a clear predominance of a few pathogens was observed.

PD140 / #497

IS IL-6 A RELIABLE MARKER FOR DIAGNOSIS OF EARLY NEONATAL SEPSIS ALONE OR IN COMBINATION?

E-Posters

POSTER DISCUSSION SESSION 09: BIOMARKERS & SEPSIS

Julia Eichberger, Bernhard Resch

Medical University Graz, Research Unit For Neonatal Infectious Diseases And Epidemiology, Graz, Austria

Backgrounds: Neonatal sepsis is a major cause of morbidity and mortality in both preterm and term infants. Early onset neonatal sepsis (EONS) presents within the first 72h of life. Diagnosis is difficult as signs and symptoms are nonspecific, and inflammatory markers are widely used to confirm or rule out neonatal sepsis. Interleukin-6 (IL-6) is part of the fetal inflammatory response syndrome (FIRS) and therefore an interesting early marker for neonatal sepsis.

Methods: IL-6 diagnostic accuracy studies for diagnosing EONS published between 1990 and 2020 were retrieved using the PubMed database. The diagnostic potential of IL-6 was analyzed systematically in term and preterm infants, cord and peripheral blood and in dependence of timing of sample collection. Sensitivity and specificity were reported and subgroup analysis was performed. A STARD checklist adapted for neonates with neonatal sepsis was used for quality assessment.

Results: We identified 31 studies on IL-6 diagnostic accuracy for EONS diagnosis between 1990 and 2020 including a total of 3276 infants. The range of IL-6 sensitivity and specificity in neonatal samples was 42.1% to 100% and 43% to 100%, the median values were 83% and 83.3%, respectively. IL-6 accuracy was better in preterm infants than in mixed study populations. Cord blood IL-6 had higher diagnostic value compared to peripheral blood, early sample collection improved sensitivity. The biomarker combination of IL-6 and CRP was found to be highly sensitive, but poorly specific.

Conclusions/Learning Points: IL-6 has a good performance as an early diagnostic marker of EONS within a study population of preterm infants, with best results for cord blood IL-6 using cut-off values above 30 pg/mL.

WHOLE-GENOME SEQUENCES INVESTIGATION ON NEONATAL BLOODSTREAM INFECTION PATHOGENS: THE ROLE OF GUT-BLOOD AXIS

E-Posters

POSTER DISCUSSION SESSION 09: BIOMARKERS & SEPSIS

Laura Folgri¹, Aurora Piazza², Francesco Comandatore³, Lucia Barcellini¹, Emanuela Boselli¹, Adam Witney⁴, Gian Vincenzo Zuccotti¹, Mike Sharland⁵

¹Ospedale dei Bambini V. Buzzi, Department Of Paediatrics, Milan, Italy, ²University of Pavia, Clinical-surgical, Diagnostic And Pediatric Sciences Department, Pavia, Italy, ³Luigi Sacco Hospital, University of Milan, 2sky Net Unimi Platform - Pediatric Clinical Research Center Romeo Ed Enrica Invernizzi, Dipartimento Di Scienze Biomediche E Cliniche, Milan, Italy, ⁴St George's University of London, Institute Of Infection And Immunity, London, United Kingdom, ⁵St George's University of London, Paediatric Infectious Disease Research Group, Institute For Infection And Immunity, London, United Kingdom

Backgrounds: Previous studies are consistent in showing a relationship between microorganisms causing colonisation and bloodstream infections in neonates. However, the mechanisms leading from colonisation to infection are still debated. Clarifying this link might have a significant impact on clinical management. Our aim was to investigate the relatedness between Enterobacterales isolated from blood (B) and faeces (F) of septic neonates.

Methods:: Paired samples (B-F) were collected from European infants <90-day on behalf of the NeoMero1 Project between 2012–2014. Isolates were identified by MALDI-TOF mass spectrometry and characterised by Whole-Genome Sequencing (WGS, Illumina MiSeq platform) and MultiLocus Sequence typing (MLST). Gut samples were collected at different time-point (sepsis onset, end-of-treatment and 28-day follow-up).

Results: In 21 infants, the same species was isolated from B and F, for a total of 48 isolates. *Enterobacter* spp. was the most represented (n=31) followed by *Escherichia coli* (n=9) and *Klebsiella* spp. (n=8). The WGS results revealed a high genetic variability, with three STs identified for *Klebsiella oxytoca* (of which two new), three for *Enterobacter asburiae*, seven for *E. cloacae* (with ST90 as the most represented), and four for *Escherichia coli* (with ST69 as the most isolated). Among the 15 cases of strains collected from B and F within the 24 hours, in only two cases (one *E. coli* and one *K. oxytoca*) the strains isolated belonged to two different STs.

Conclusions/Learning Points: This result supports the idea that blood infections could be related to intestinal colonisation. Very few studies attempted to ascertain the relatedness between colonising and invasive pathogens. If a correlation is confirmed, easy-to-collect rectal swab data could be used as a proxy, at patient- or NICU-level, to inform empirical antibiotic treatment in neonates with suspected sepsis.

ELEVATED HIGH-SENSITIVITY TROPONIN AND NT-PROBNP VALUES IN FEBRILE CHILDREN

E-Posters

POSTER DISCUSSION SESSION 09: BIOMARKERS & SEPSIS

Dorine Borensztajn¹, Chantal Tan², Yolanda De Rijke³, Nienke Hagedoorn¹, Sascha Verbruggen⁴, Henriette Moll¹, Clementien Vermont⁵

¹Erasmus MC, General Pediatrics, Rotterdam, Netherlands, ²Erasmus Medical Center - Sophia Children's Hospital, General Pediatrics, Rotterdam, Netherlands, ³Erasmus MC, Department Of Clinical Chemistry, Rotterdam, Netherlands, ⁴Erasmus MC, Enlive Care, Department Of Pediatrics And Pediatric Surgery, Rotterdam, Netherlands, ⁵Erasmus MC-Sophia Children's Hospital, Department Of Paediatric Infectious Diseases And Immunology, Rotterdam, Netherlands

Backgrounds: The current COVID-19 pandemic and subsequent rise of multisystem inflammatory syndrome in children (MIS-C) have raised interest in high-sensitivity troponin (hs-TnT) and N-terminal pro-brain natriuretic peptide (NT-proBNP), as these have been found to be elevated in many MIS-C cases. Our aim was to study hs-TnT and NT-proBNP levels in febrile children not affected by COVID-19.

Methods:: This study took place as part of the prospective PERFORM study. Hs-TnT and NT-proBNP were measured in febrile children (0-18 years) attending the ED (N=67), admitted to the PICU (N=19) of a university medical center in the Netherlands (2017-2019) and controls (N=25).

Results: HS-TnT (median 1.8, IQR 0.0-15.1 ng/l) and NT-proBNP (194, IQR 54.9-706 pg/ml) were higher in febrile children than in controls (N=25, hs-TnT 0.0, IQR 0-0; NT-proBNP 56.3, IQR 29.7-109, both $p < 0.001$), while PICU patients had higher values (hs-TnT 15.1, IQR 10.3-102 and NT-proBNP 828 IQR 657-4,712, both $p < 0.001$) than ED patients (hs-TnT 0, IQR 0-7.4 and NT-proBNP 104 IQR 39.5-363). No differences were found between viral and bacterial infections. Highest levels were found in children with either comorbidity predisposing to elevated levels (e.g., chronic cardiac or renal disease) or children with critical illness or multi-organ failure such as those with septic shock.

Conclusions/Learning Points: HS-TnT and NT-proBNP levels are often elevated in febrile children with different causes of fever. Values were higher in children admitted to the PICU than in children attending the ED, and seem to reflect disease severity rather than the underlying cause of fever.

PD143 / #1852

LOW LEVEL VARIANTS AS POOR PROGNOSTIC INDICATORS OF CLINICAL OUTCOMES IN CYTOMEGALOVIRUS INFECTION

E-Posters

POSTER DISCUSSION SESSION 09: BIOMARKERS & SEPSIS

Cristina Venturini¹, Julia Colston², Oscar Charles³, Ana Lankina³, Claire Atkinson⁴, Paul Griffith⁴, Judith Breuer⁵

¹University College London, Institute Of Child Health, LONDON, United Kingdom, ²University Hospitals Bristol, North Bristol Nhs Trust, Bristol, United Kingdom, ³UCL, Ich, LONDON, United Kingdom, ⁴UCL, Institute For Immunity And Transplantation, LONDON, United Kingdom, ⁵UCL Great Ormond Street Institute for Child Health, Infection, Immunity And Inflammation Research Department, London, United Kingdom

Backgrounds: Human cytomegalovirus (HCMV) is a common cause of viral infection in immunocompromised individuals, increasing the risk of morbidity and mortality in both hematopoietic and solid organ transplant recipients. Together with host factors, viral characteristics, such as resistance mutations and the presence of multiple viral strains, may play a role in the development and progression of the disease.

Methods:: To assess the dynamics of viral populations we used target-enrichment to deep-sequence 16 paediatric patients with HCST, solid organ transplant, or primary immunodeficiency of whom 7 died with CMV and 34 infected solid organ transplant adult recipients of whom one died with CMV.

Results: We identified resistance mutations to antiviral drugs in the protein kinase and DNA polymerase genes. Fixed resistance (>50%frequency) mutations were identified in 5/43 patients in the good outcome group and 3/8 in the poor outcome group. We also identified 25-28% of patients have multiple HCMV strains and in our cohort, mixed infections were not predictive of clinical outcomes. Deep-sequencing also revealed non-fixed GCV and FOS resistance mutations in 6/8 in the poor outcome vs 2/43 in the good outcome group. In the longitudinal samples, low-frequency resistance mutations persisted with the majority failing to rise to fixation. Looking at the whole genome we identified a ten genes signature that allowed us to discriminate samples from the two groups. We also examined lymphocytes counts from a subset of patients, of whom 2 belonged to the poor outcome group. Both patients showed no recovery of lymphocyte count after transplant, suggesting a link between immunity and our viral signature.

Conclusions/Learning Points: This viral signature, probably reflecting the failure of immune control, could be used to aid current diagnostics in identifying patients who might fail antiviral therapy. [SEP]

ETIOLOGY OF PEDIATRIC BACTEREMIA IN CENTRAL GREECE, 2010-2020

E-Posters

POSTER DISCUSSION SESSION 09: BIOMARKERS & SEPSIS

Athanasios Gkoutzourelas, Stavroula Kontogianni, Aspasia Michoula, Christina Tsiontsi, Areti Stefani, Paraskevi Rozou, Vassiliki Papandreou, George Syrogiannopoulos, Ioanna Grivea
 University of Thessaly, Department Of Pediatrics, Larissa, Greece

Backgrounds: Blood cultures are commonly performed in hospitalized children with febrile illness in order to identify bacteremia.

Methods: This is a study of bacteremia cases among children hospitalized in a Greek tertiary pediatric department.

Results: In the 11-year study period, 18,480 children were hospitalized. During the first 48 hours after admission, one or more blood cultures were obtained from 6,891 children with acute febrile illness; 130 (1.9%) had a positive culture considered as representing "true bacteremia" (2.1% in 2010-2013, 1.5% in 2014-2017 and 1.9% in 2018-2020). In addition, 120 positive blood cultures were considered as representing "contamination". Microorganisms, such as coagulase-negative staphylococci, *Staphylococcus epidermidis*, *S. hominis*, *Streptococcus viridans* and *Micrococcus* spp., typically considered as contaminants from the skin, were included in the analysis only if they had been isolated in ≥ 2 blood cultures during the same hospitalization. In each true bacteremia case the recovered pathogen was reported once, even if detection was confirmed in >1 blood cultures. The seven most frequently isolated pathogens per time-period are presented in Figure 1. *S. aureus* was the most common pathogen isolated followed by *Brucella* spp. Overtime, no significant change in the frequency of a specific pathogen was observed. Figure 1. Distribution of recovered bacterial pathogens during the study period

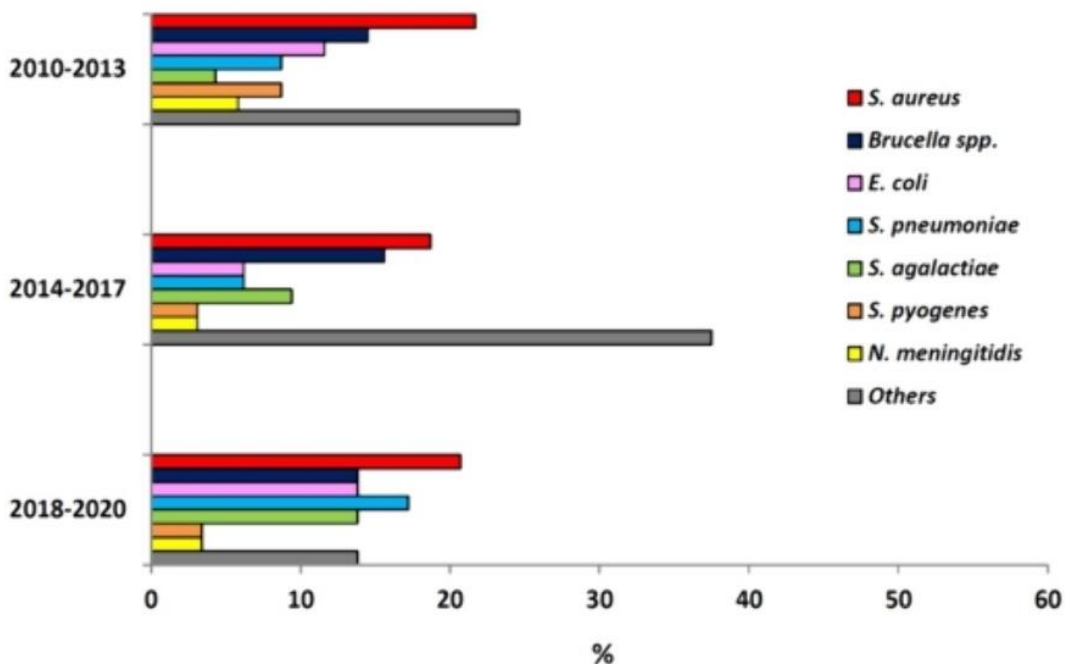

Conclusions/Learning Points: Among hospitalized children with possible bacteremia the percentage of positive blood cultures remained low. *S. aureus* was the most frequently isolated pathogen. Prior antibiotic treatment, relatively low bacterial load, or difficulties in the isolation of specific bacteria may contribute to the low percentage of identification of the etiologic agent.

IMPROVING ACCESS TO THE NEONATAL EARLY-ONSET SEPSIS CALCULATOR: AN OPEN-SOURCE SCRIPT TO FACILITATE LOCAL USE, ELECTRONIC INTEGRATION AND FURTHER RESEARCH

E-Posters

POSTER DISCUSSION SESSION 10: CONGENITAL & PERINATAL AND NEONATAL INFECTIONS

Niek Achten¹, Bo Van Der Weijden², William Benitz³, Frans Plötz²

¹ErasmusMC, Pediatrics, Rotterdam, Netherlands, ²Tergooi, Pediatrics, Blaricum, Netherlands, ³Stanford University School of Medicine, Pediatrics, Palo Alto, United States of America

Backgrounds: Kaiser Permanente Perinatal Research Division developed the neonatal early-onset sepsis (EOS) calculator – a risk prediction tool that has led to drastic reductions in unnecessary empiric antibiotics. A central, peer-reviewed publication documenting the exact mechanisms and allowing precise replication and integration of the EOS calculator tool is missing, making neonatal clinics worldwide dependent on the website of Kaiser Permanente.

Methods: After detailed technical assessment of the EOS calculator tool, we constructed a script for R statistical software, using previously published intercepts, coefficients (to provide a pre-examination risk) and likelihood ratios for the neonatal clinical status categories (to construct the post-examination risk) and incorporated the algorithm described by the EOS calculator publications. so that the script also provides users with right EOS calculator recommendation as an output. Validation of the script was done using with extreme input variables at the end of input ranges and a previously established clinical database of 234 verified EOS cases.

Results: Components of the script reproducing exact results of the current online EOS calculator tool are shown in Figure 1. Preliminary validation of the tool by comparing results of the online tool and our script using maximum and minimum input values and a previously established database of neonatal EOS cases showed perfect agreement between the Kaiser Permanente online EOS calculator and our final script (234 of 234 cases, 100%).

| EOS Calculator components | | |
|--|--|--|
| 1. Maternal risk factor input | Input (range, format) <i>Transformation, and or multiple use of input variable</i> | Beta (β) coefficient(s) |
| EOS incidence rate per 1000 live births (categorical) | 0.1 – 1 in increments of 0.1 | 0.3 40.0528 |
| | 2 | 0.4 40.3415 |
| | 4 | 0.5 40.5656 |
| | | 0.6 40.7469 |
| Gestational age (weeks, days) | Weeks: 34–43, integer Days: 0–6, integer <i>Final input in model: weeks+1/7*days, rounded to 2 decimals. Also entered in model as (Gestational age)*2</i> | beta coefficients outside this range (0.3-0.6) have not been published Gestational age -6.9325 (Gestational age)*2 0.0877 |
| | Maximum maternal intrapartum temperature (°C or °F) Celsius: 0–40, numerical, 1 decimal Fahrenheit: 96–104, numerical, 1 decimal <i>If input in Celsius, convert to Fahrenheit: ((degrees C)*9/5)+32</i> | 0.8680 |
| Duration of membrane ruptures (hours) | 0–240, numerical, 1 decimal <i>Transformation after input: [input (hrs) + 0.05]*0.2</i> | 1.2256 |
| Maternal GBS colonization status (categorical) | Positive (highest risk) | 0.5771 |
| | Unknown | 0.0427 |
| | Negative (lowest risk) | N/A (reference category) |
| | No antibiotics before delivery or antibiotics <2 hrs before delivery (highest risk) | N/A (reference category) |
| Type and duration of intrapartum antibiotics (categorical) | Broad antibiotics 2–4 hrs before delivery | -1.0488 |
| | Group B Streptococcus specific antibiotics | -1.0488 |
| | Broad spectrum antibiotics > 4 hrs prior to birth (lowest risk) | -1.1861 |
| | | |
| 2. Calculation of pre-examination risk | Step 1. Calculate logit(p) 2. Calculate pre-examination probability 3. Calculate pre-examination risk | Calculation Logit(p) = [β EOS incidence] + [(gestational age) * -6.9325] + [(gestational age) ² * 0.0877] + [intrapartum temperature] * 0.8680 + [(duration of ruptured membranes) + 0.05] * 0.2 * 1.2256 + β [Maternal GBS colonisation status] + β [Type and duration of intrapartum antibiotics] Pre-examination probability = 1 / (1 + e ^{logit(p)}) [Pre-examination probability] * 1000 |
| 3. Newborn clinical status | Status category Well Appearing (lowest risk) Equivocal Exam Clinical Illness (highest risk) | Upper bound of 95% confidence interval of associated likelihood ratio 0.41 5.0 21.2 |
| 4. Calculation of post-examination risk | Step 1. Calculate posterior odds 2. Calculate post-examination probability 3. Calculate post-examination risk | Calculation [(Pre-examination probability) / (1 - Pre-examination probability)] * [Upper bound of 95% confidence interval of associated likelihood ratio] [Posterior odds] / (1 + [Posterior odds]) [Post-examination probability] * 1000 |
| 5. Determination of management recommendation | Recommendation "Obtain blood culture and administer empirical antibiotics" "Strongly consider empirical antibiotics" "Obtain blood culture and monitor vital signs every 4h" "Monitor vital signs every 4h" "Routinely monitor vitals" | Conditions If post-examination risk ≥3 per 1000 live births. Clinical illness but post-examination risk <3 per 1000 live births. No clinical illness but post-examination risk between 1 and 3 per 1000 live births. No clinical illness and post-examination risk <1, but pre-examination risk ≥1 No clinical illness and both post-examination risk and pre-examination risk <1 |

Conclusions/Learning Points: Success and widespread use of the EOS calculator warrant detailed documentation and access beyond the current online tool on the website of Kaiser Permanente. We present a validated open-source script providing the same functionality that will be publicly available, which may help facilitate electronic integration, reduce clinicians' dependency, and improve scientific evaluation of the tool.

PD146 / #1190

MATERNAL COLONISATION AND INVASIVE GROUP B STREPTOCOCCAL DISEASE (IGBS) IN KAMPALA, UGANDA.

E-Posters

POSTER DISCUSSION SESSION 10: CONGENITAL & PERINATAL AND NEONATAL INFECTIONS

Hannah Davies¹, Mary Kyohere², Valerie Tusubira³, Alexander Amone², Lydia Nakibuuka², Melanie Etti¹, Pooja Ravji⁴, Hannington Tasimwa⁵, Annetee Nakimuli⁶, Philippa Musoke², Musa Sekikubo⁶, Kirsty Le Doare⁴

¹St George's University of London, Infection & Immunity, London, Uganda, ²Makerere University John Hopkins Research Collaboration, Medical Research, Kampala, Uganda, ³Makerere University John Hopkins Research Collaboration, Data Management, Kampala, Uganda, ⁴St George's, University of London, Infection & Immunity, London, United Kingdom, ⁵Makerere School of Medicine, Department Of Medical Microbiology, Kampala, Uganda, ⁶Makerere University, Department Of Obstetrics & Gynaecology, Kampala, Uganda

Backgrounds: The last ten years have seen major improvements in under-five mortality rates in many regions of Africa. However, the unacceptably high death rates amongst newborns have not declined at the same rate. One-third of these deaths are due to severe infection. Group B Streptococcus meningitis and severe bloodstream infection are likely to be major contributors to the very high disease burden in Africa, however, data on maternal colonisation and invasive GBS disease (iGBS) are limited. We aimed to describe the epidemiology of maternal and young infant disease in Kampala, Uganda.

Methods: A prospective cohort and nested case-control study were conducted across two-centres with two entry points. A) consecutive women and their infants at birth, with collection of maternal swab, cord and maternal blood, and follow up by telephone until the infant is 3 months old (birth cohort); B) any infant <3 months of age, presenting with signs of sepsis, with collection of blood culture, cerebrospinal fluid and nasopharyngeal swabs (surveillance cohort). Babies with iGBS from either cohort were consented for neurodevelopmental follow-up until 2 years old.

Results: 6062 women were recruited into the study between April 2019 and March 2020, they delivered 6230 babies, of whom 61 (0.98%) were stillborn. 5746 (94.8%) women had rectal/vaginal swabs collected and (14.7%) were colonised with GBS. 91% of eligible babies were followed-up until 3 months of age. 7324 blood cultures were collected, 791 were positive and 29 cases of invasive GBS disease (86.2% early-onset) were identified, 5 of whom came from the birth cohort.

Conclusions/Learning Points: GBS is an important cause of infant disease in Uganda. Maternal GBS vaccination is a key opportunity to reduce maternal disease, stillbirths and neonatal deaths in this high burden region.

CONGENITAL CYTOMEGALOVIRUS SCREENING IN HIV-EXPOSED NEWBORNS

E-Posters

POSTER DISCUSSION SESSION 10: CONGENITAL & PERINATAL AND NEONATAL INFECTIONS

Christina Von Kietzell¹, Bernd Buchholz², Anita Rack-Hoch³, Ulrich Von Both³, Christoph Königs⁴, Holger F. Rabenau⁵, Rolf L. Schloesser¹, Horst Buxmann¹

¹University Hospital Frankfurt, Department Of Neonatology, Frankfurt, Germany, ²University Children's Hospital, Medical Faculty Mannheim, Department Of Hematology And Oncology, Mannheim, Germany, ³Dr. von Hauner Children's Hospital, Division Of Paediatric Infectious Diseases, Munich, Germany, ⁴University Hospital Frankfurt, Department Of Paediatrics And Adolescent Medicine, Frankfurt am Main, Germany, ⁵University Hospital Frankfurt, Institute For Medical Virology, Frankfurt am Main, Germany

Backgrounds: Congenital Cytomegalovirus-infections (cCMV) are a leading cause for hearing and neurological impairment. In retroviral exposed neonates, the incidence of cCMV is reported to be 2.7-6.5% worldwide. HIV-exposed newborns seems to have a higher risk of cCMV-infection than unexposed newborns with an estimated incidence of 0.2–0.5% in Germany.

Methods: In this prospective multicentre study, screening for cCMV-infection was performed in a German cohort of HIV-exposed newborns. Saliva specimen was tested for CMV-DNA by real-time PCR within the first three weeks of life. Additional urine and blood samples were analysed for CMV-DNA to verify positive saliva results. Further diagnostics were performed to detect cCMV-related symptoms: Detailed physical-neurological examination, blood analysis, ultrasound of the head and abdomen, hearing test (AABR) and visual examination.

Results: 122/184 (66.3%) HIV-exposed neonates born from 121 mothers during the study period from 24/11/2017 to 31/03/2021 were eligible for enrolment. There was no mother-to-child transmission of HIV. 74/77 HIV-infected mothers with known CMV-serostatus were CMV-IgG positive (96.1%). A cCMV-infection was detected in one of 122 HIV-exposed neonates, corresponding to a cCMV incidence of 0.82% in our cohort. This cCMV infected newborn suffered from CNS disease with subependymal cysts on both sides and thalamostriatal vasculopathy on the right. Antiviral therapy with Antiviral therapy with valganciclovir was offered and started on day 20 of life.

Conclusions/Learning Points: This study shows a higher incidence of cCMV in HIV-exposed neonates than the estimated value for non-HIV-exposed newborns in Germany. Thanks to our cCMV-screening protocol, a symptomatic cCMV-infected newborn was identified and treated in time, which would have been missed in regular standard care. These results needs to be verified in further prospective studies with greater cohorts. CCMV-screening in HIV-exposed newborns should be considered.

LIFESTYLE HABITS AS INDEPENDENT RISK FACTORS FOR TOXOPLASMA GONDII INFECTION DURING PREGNANCY. WHAT MAY AFFECT THE DEVELOPING FETUS?

E-Posters

POSTER DISCUSSION SESSION 10: CONGENITAL & PERINATAL AND NEONATAL INFECTIONS

Carlo Bieńkowski¹, Małgorzata Aniszewska¹, Jolanta Popielska¹, Konrad Zawadka¹, Agnieszka Ołdakowska², Maria Pokorska-Śpiewak¹

¹Medical University of Warsaw, Department Of Children's Infectious Diseases, Warsaw, Poland, Warsaw, Poland, ²Medical University of Warsaw, Department Of Children's Infectious Diseases, Warsaw, Poland, Warszawa, Poland

Backgrounds: *Toxoplasma gondii* (TG) is a parasitic protozoa. Two major routes of infection in humans include oral and congenital transmission. The course of infection is usually asymptomatic/mild. However, it may cause miscarriages or birth defects if the infection occurs during pregnancy. The aim of the study was to evaluate the risk factors for TG infection in pregnant women. The implementation of recommended screening tests towards other congenital infections was also analyzed. The aim of the study was to evaluate the risk factors for TG in pregnant women.

Methods: Medical charts of 273 pregnant women with suspected TG infection admitted to the Department of Children's Infectious Diseases between 1st December 2019 till 14th March 2020 were retrospectively analyzed. The analysis included anamnesis data on potential risk factors for TG infection. Implementation of screening tests towards other vertical infections was also checked. The presumptive TG diagnosis was verified using serologic assessment of IgM, IgG titers, and IgG affinity tests.

Results: Median age was 32 years (range: 19-42 years). The diagnosis of primary TG infection was confirmed in 74/273 (27.1%) women. In 114/273 (41.8%) the infection occurred in the past. In 71/273 (26%) women the infection was excluded. The remaining women (14/273, 5.1%) had inconclusive results, and the reassessment was recommended. In 172/273 (62%) women the recommended testing towards other infectious diseases dangerous for the fetus development was carried out correctly. Logistic regression model results are presented in Table 1.

Conclusions/Learning Points: Independent risk factors for TG infection in pregnancy are living in rural area, and eating raw meat. Only in 62% of women the recommended testing was carried out correctly. Educational role of a physician in these matters is crucial for efficient prevention of congenital

toxoplasmosis.

Table 1.
Univariate and multivariate logistic regression analysis of factors associated with primary *Toxoplasma gondii* infection

| Factor | Univariate | | | Multivariate | | |
|----------------------|------------|-------------------------|---------|--------------|-------------------------|---------|
| | Odds ratio | 95% Confidence interval | p-value | Odds ratio | 95% Confidence interval | p-value |
| living in rural area | 3.17 | 1.59-6.32 | 0.001 | 2.89 | 1.42-5.9 | 0.004 |
| eating raw meat | 2.25 | 1.59-4.38 | 0.017 | 2.07 | 1.03-4.18 | 0.04 |
| cats caregiving | 2.11 | 1.07-4.16 | 0.03 | 1.65 | 0.8-3.39 | 0.17 |
| wild cats caregiving | 2.22 | 1-4.9 | 0.049 | 1.72 | 0.72-4.1 | 0.22 |
| home cats caregiving | 2.27 | 1.05-4.92 | 0.03 | 1.83 | 0.79-4.27 | 0.16 |

Data are presented as odds ratio (95% CI), P value. Candidate predictors were entered into the model irrespective of the results of the univariate analysis. After entering all variables to the model, the variables that showed least significant associations were subsequently excluded until all variables remained significant ($P < 0.05$).

PD149 / #689

PREDICTIVE SCORES IN EARLY DIAGNOSIS OF LATE-ONSET NEONATAL SEPSIS: WHAT HAVE WE DONE SO FAR? A SYSTEMATIC REVIEW

E-Posters

POSTER DISCUSSION SESSION 10: CONGENITAL & PERINATAL AND NEONATAL INFECTIONS

Georgia Anna Sofouli, Aimilia Kanellopoulou, Despoina Gkentzi, Gabriel Dimitriou
Patras Medical School, University of Patras, Department Of Paediatrics, Patras, Greece

Backgrounds: Late-onset neonatal sepsis (LOS) represents a significant cause of mortality and morbidity worldwide and early diagnosis remains a great challenge. Various 'sepsis scores' have been introduced to clinical practice in order to improve early identification of LOS. The aim of the current study is to present existing evidence on the diagnostic value of predictive scores in LOS as a tool for early sepsis recognition and restriction of unnecessary antimicrobial use.

Methods: A systematic search was performed in the PUBMED database including all published articles in English from 1982 (first predictive score) up to June 2021. The following research question was developed: Can we diagnose with accuracy LOS in neonates by means of a predictive score? The following search terms were used in various combinations: neonat*, newborn, infant, predict*, diagnos*, identif*, scor*, system, model, algorithm*, calculator, tool, sepsis, septic*, bloodstream infection.

Results: Our search identified 1352 articles out of which 16 were included in the review (15 original studies). Eight were prospective, 4 retrospective and 2 were mixed studies. Predictive models were developed by combining a variety of physical examination findings, laboratory assessments and other variables and composing scores. The majority of the scores were found to assist in early diagnosis and rationalise antibiotic usage, but almost all performed limited diagnostic accuracy.

Conclusions/Learning Points: Identifying septic neonates accurately is crucial to treat a newborn precisely, guide the optimal use of antibiotics and decrease antimicrobial resistance. Combinations of selected clinical and laboratory parameters may predict septicemia in Neonatal Units and contribute in early confrontation. The sepsis prediction scores may be helpful for clinicians in order to improve clinical decision making.

PD150 / #1005

RISK FACTORS ASSOCIATED WITH THE DEVELOPMENT OF NEUTROPENIA POST (VAL)GANCICLOVIR TREATMENT FOR CONGENITAL CMV INFECTION.

E-Posters

POSTER DISCUSSION SESSION 10: CONGENITAL & PERINATAL AND NEONATAL INFECTIONS

Artemis Mavridi¹, Garyfallia Syridou¹, Danai Ktena¹, Dimitra Dimopoulou², Nikolaos Siafakas³, Vassiliki Papaevangelou¹

¹National and Kapodistrian University of Athens, Third Department Of Pediatrics, Attikon University Hospital, Athens, Greece, ²National and Kapodistrian University of Athens, Second University Department Of Pediatrics, "p. & A. Kyriakou" Children's Hospital Of Athens, Athens, Greece, ³Attikon University Hospital, Microbiology Department, Athens, Greece

Backgrounds: Congenital Cytomegalovirus (cCMV) infection is the leading cause of non-genetic sensorineural hearing loss (SNHL) and a major cause of neurodevelopmental impairment in children. The only available, still off-label, treatment for symptomatic disease is the oral prodrug of ganciclovir, valganciclovir. Neutropenia is frequently observed and the main cause for therapy discontinuation. We aimed to describe our experience and examine potential risk factors associated with the development of neutropenia.

Methods: Infants with cCMV diagnosed and treated in our department between January 2011 and December 2021, were included. Demographics, clinical, laboratory and treatment data were recorded.

Results: Overall, 33 newborns were included. Fifteen infants were treated for 6 weeks and another 15 for 6 months. In one case, treatment was discontinued after 10 days due to severe neutropenia and in two cases treatment is still ongoing. Neutropenia was observed in 14 infants; seven infants developed moderate ($<1000/\text{mm}^3$) and 7 severe neutropenia ($<500/\text{mm}^3$). Four infants required Granulocyte Colony-Stimulating-Factor treatment. Notably, one infant with severe neutropenia additionally developed Klebsiella septicemia and anemia that required blood transfusion. Gestational age, birth weight, duration of therapy, administration route, neonatal baseline neutrophil count and CMV-DNA viral load at birth were not correlated with drug-induced neutropenia. Interestingly, babies born post maternal primary CMV-infection that occurred during the first trimester of pregnancy, were more likely to develop neutropenia (p-value=0.01).

Conclusions/Learning Points: Among cCMV infected children receiving treatment with (val)ganciclovir, maternal infection in the first trimester of pregnancy appeared to be the only identifiable risk factor for the occurrence of neutropenia. This finding potentially indicates that viral induced bone marrow dysfunction may play a crucial role in the pathogenesis. Larger studies are needed to confirm these findings.

PD151 / #1380

MRI BRAIN FINDINGS AND LIKELIHOOD OF DEVELOPING SEIZURES IN INFANTS WITH CONGENITAL CMV

E-Posters

POSTER DISCUSSION SESSION 10: CONGENITAL & PERINATAL AND NEONATAL INFECTIONS

George Lawson, Styliani Alifieraki, Carolina Kachramanoglou, Wajanat Jan, Hermione Lyall
Imperial Healthcare NHS Trust, Paediatric Infectious Diseases, London, United Kingdom

Backgrounds: Children born with congenital CMV (cCMV) have an increased risk of brain injury and of developing seizures. More severe changes on imaging are associated with a poor prognosis. The aim of this study is to identify the particular imaging features and value of a scoring system of baseline neonatal brain MRIs in predicting the likelihood of developing seizures.

Methods: Records were reviewed for 155 patients referred with cCMV between April 2012 and July 2021. Patients were excluded if they did not have cCMV, were over 2 years old at time of diagnosis, or did not have an MRI scan available for review. Each MRI was assessed by three neuroradiologists and given a score of 0, 1, 2, or 3 for normal, structural abnormality alone, white matter abnormality alone, white matter abnormality plus structural lesion, respectively.

Results::

Number

Occipital Head Circumference (median Z score)

Birth weight (median Z score)

Gestation (median weeks)

Score_MR

0

1

2

3

Cortical malformation

Cysts

Calcification

11.27% of children with cCMV developed seizures. The median age of first seizure was 11.5 months, and four of eight children had a seizure before they were 1 year old. Six had recurrence of seizures, and seven were started on antiepileptic medicine.

Conclusions/Learning Points: A higher brain MRI score, representing more severe abnormalities, was associated with a greater likelihood of seizures.

3.57% scoring 0-1 developed seizures, 16.67% scoring 2-3 did, highlighting that the

presence of cortical malformation, calcification and cysts increase the likelihood of seizures.

HEMOSTATIC ALTERATIONS IN SEPTIC NEONATES IN CONVENTIONAL COAGULATION TESTS AND ROTEM PARAMETERS

E-Posters

POSTER DISCUSSION SESSION 10: CONGENITAL & PERINATAL AND NEONATAL INFECTIONS

Dimitra Gialamprinou¹, Georgios Mitsiakos¹, Abraham Pouliakis², Georgios Katsaras¹, Christos-Georgios Kontovazainitis¹, Ilias Chatziioannidis¹, Athanasios Moraitis¹, Anastasia Banti³, Alexandra Fleva³, Emmanuel Roilides⁴, Elissavet Diamanti¹

¹Aristotle University of Thessaloniki, "Papageorgiou" General Hospital of Thessaloniki, Second Neonatal Department And Neonatal Intensive Care Unit, Thessaloniki, Greece, ²National and Kapodistrian University of Athens, "ATTIKON" University Hospital, Second Department Of Pathology, Athens, Greece, ³"Papageorgiou" General Hospital of Thessaloniki, Hemostasis Unit, Department Of Hematology, Thessaloniki, Greece, ⁴Hippokraton University Hospital, Medical School, Aristotle University of Thessaloniki, Third Department Of Paediatrics, Thessaloniki, Greece

Backgrounds: Rotational thromboelastometry (ROTEM) is well established in assessing adult sepsis associated coagulopathy. We aimed to assess coagulation during neonatal sepsis with ROTEM compared to conventional coagulation tests.

Methods:: A prospective study in septic neonates was conducted from 01/2020 to 10/2021. Conventional coagulation tests and ROTEM variables were measured.

Results: Twenty-eight preterm hospitalized septic neonates were compared with 30 matched healthy controls. Septic neonates, on the first day had prolonged INTEM CFT and reduced a, higher FIBTEM A10, A20, A30, MCF, LI45, LI60 (Table 1). On the 2nd-3rd day they had higher INTEM LI60, FIBTEM A10, A20, A30, MCF, LI45, LI60. On 5th-7th day they had higher INTEM A10, A20, A30, MCF, a and reduced CFT, higher EXTEM A10, A20, A30, MCF, a and reduced CFT, and reduced FIBTEM CT, higher A10, A20, A30, MCF, a. Regarding the classical coagulation tests: on first day septic neonates had longer PT and aPTT, higher fibrinogen; on the 2nd-3rd day, they had longer aPTT, higher fibrinogen; on the 5th-7th day, they had longer aPTT. Septic neonates during sepsis had increased INTEM A10, A20, A30, MCF, a and reduced CFT, reduced EXTEM CT, CFT and increased A10, A20, A30, MCF, a, and increased FIBTEM

a.

Table 1. Conventional coagulation tests and ROTEM parameters in septic and healthy neonates.

| Characteristic | Septic neonates | | | | | | Healthy neonates | | Day 1 vs healthy neonates | Days 2-4 vs healthy neonates | Days 5-7 vs healthy neonates | During sepsis | | |
|---------------------------------------|------------------|--------------------|------------------|------------------|---------------|------------------|------------------|-------------------|---------------------------|------------------------------|------------------------------|---------------|----------|----------|
| | Day 1 | | Days 2-4 | | Days 5-7 | | N | Median (IQR) | | | | | P-value* | P-value* |
| Conventional coagulation tests | | | | | | | | | | | | | | |
| PT (seconds) | 28 | 14.4 (13.2-16.6) | 27 | 13 (12.3-13.2) | 28 | 12.8 (12.3-13.2) | 30 | 12.8 (11.8-13.2) | <0.001 | 0.00107 | 0.03718 | - | | |
| aPTT (seconds) | 28 | 18.91 (16.47-24.3) | 27 | 16.41 (14.3) | 28 | 15.1 (12.1-18.5) | 30 | 16.11 (14.4-17.7) | <0.001 | 0.00141 | 0.00079 | - | | |
| Fibrinogen (mg/dl) | 28 | 400 (314-464) | 27 | 381 (261-423) | 28 | 394 (245-395) | 30 | 257 (218-316) | <0.001 | 0.00012 | 0.05141 | - | | |
| D dimers (ng/ml) | 28 | 2161 (1650-3500) | 25 | 2280 (1600-3340) | 21 | 1500 (1100-2060) | 28 | 1175 (700-1473) | <0.001 | <0.001 | 0.05353 | - | | |
| ROTEM parameters | | | | | | | | | | | | | | |
| INTEM | CT (seconds) | 28 | 208 (178-243) | 28 | 211 (174-238) | 28 | 191 (181-211) | 30 | 203 (172-250) | 0.628 | 0.966 | 0.269 | 0.124 | |
| | A10 (millimoles) | 28 | 66 (56-83) | 28 | 63 (58-87) | 28 | 67 (61-71) | 30 | 60 (56-66) | 0.111 | 0.666 | 0.069 | <0.001 | |
| | A20 (millimoles) | 28 | 63 (52-87) | 28 | 64.2 (61-70) | 28 | 70 (66-72) | 30 | 64 (59-68) | 0.374 | 0.582 | 0.066 | <0.001 | |
| | A30 (millimoles) | 28 | 62 (58-66) | 28 | 64 (64-69) | 28 | 69 (65-71) | 30 | 63 (59-67) | 0.210 | 0.483 | 0.069 | <0.001 | |
| | CFT (seconds) | 28 | 70 (59-101) | 28 | 52 (45-72) | 28 | 43 (37-51) | 30 | 61 (64-68) | 0.037 | 0.972 | 0.066 | <0.001 | |
| | MCF (millimoles) | 28 | 63 (52-87) | 28 | 62 (62-76) | 28 | 70 (66-75) | 30 | 64 (60-69) | 0.216 | 0.361 | 0.066 | 0.001 | |
| | Alpha (degrees) | 28 | 78 (72-78) | 28 | 79 (72-81) | 28 | 81 (80-82) | 30 | 78 (76-81) | 0.036 | 0.893 | 0.019 | <0.001 | |
| | LI45 (%) | 28 | 33 (30-35) | 28 | 36 (36-37) | 28 | 33 (34-36) | 30 | 33 (34-36) | 0.402 | 0.242 | 0.297 | 0.740 | |
| | LI60 (%) | 28 | 82.5 (80-92) | 28 | 81.92 (81-96) | 28 | 83 (81.3-86) | 30 | 82 (80-94) | 0.708 | 0.848 | 0.205 | 0.244 | |
| | EXTEM | CT (seconds) | 28 | 14 (10-16.5) | 28 | 11 (7-12.3) | 28 | 12.5 (10-15.1) | 30 | 16.2 (14-15.5) | 0.058 | 0.449 | 0.047 | 0.001 |
| | | A10 (millimoles) | 28 | 61.5 (51-84) | 28 | 63 (59-87) | 28 | 66.5 (59-72) | 30 | 60 (51-64) | 0.918 | 0.442 | 0.018 | 0.019 |
| A20 (millimoles) | | 28 | 64.5 (50.5-86.5) | 28 | 63 (60-71) | 28 | 69.5 (61-75) | 30 | 64.5 (58-69) | 0.919 | 0.527 | 0.012 | 0.012 | |
| A30 (millimoles) | | 28 | 63 (60-67) | 28 | 63 (60-71) | 28 | 66.5 (61-72) | 30 | 63.5 (58-69) | 0.939 | 0.465 | 0.019 | 0.018 | |
| CFT (seconds) | | 28 | 73 (61-91.3) | 28 | 63 (49-79) | 28 | 54 (42-84) | 30 | 67.5 (52-83) | 0.097 | 0.842 | 0.043 | 0.001 | |
| MCF (millimoles) | | 28 | 64.3 (61-68.3) | 28 | 63 (61-71) | 28 | 70 (63-75) | 30 | 61 (59-68) | 0.987 | 0.486 | 0.024 | 0.041 | |
| Alpha (degrees) | | 28 | 78 (72.3-78) | 28 | 78 (78-81) | 28 | 80 (77-81) | 30 | 77 (77-80) | 0.231 | 0.431 | 0.025 | <0.001 | |
| LI45 (%) | | 28 | 86 (84-92) | 28 | 87 (84-92) | 28 | 83 (84-97) | 30 | 83.5 (84-97) | 0.339 | 0.226 | 0.293 | 0.403 | |
| LI60 (%) | | 28 | 83 (81-94) | 28 | 84 (82-94) | 28 | 80 (81.3-94.5) | 30 | 83 (80-94) | 0.260 | 0.057 | 0.497 | 0.315 | |
| FIBTEM | | CT (seconds) | 28 | 26 (17.5-60) | 28 | 25 (18-41) | 28 | 42.5 (41-49) | 30 | 22 (17-28) | 0.209 | 0.597 | 0.069 | 0.006 |
| | | A10 (millimoles) | 28 | 11 (7-25) | 28 | 22 (20-27) | 28 | 23 (20-30) | 30 | 17 (12-24) | 0.023 | 0.062 | 0.001 | 0.214 |
| | A20 (millimoles) | 28 | 23.5 (19-26.5) | 28 | 24 (20-29) | 28 | 25 (22-31) | 30 | 17 (13-24) | 0.066 | 0.061 | <0.001 | 0.263 | |
| | A30 (millimoles) | 28 | 22.5 (19-26.5) | 28 | 24 (22-29) | 28 | 24 (21-30) | 30 | 17 (13-24) | 0.001 | <0.001 | <0.001 | 0.237 | |
| | CFT (seconds) | 28 | 151 (101-167) | 28 | 116 (104-145) | 28 | 120.5 (112-160) | 30 | 185 (108-222) | 0.091 | 0.810 | 0.499 | 0.264 | |
| | MCF (millimoles) | 28 | 23 (19.5-26.5) | 28 | 24 (21-29) | 28 | 23 (22-31) | 30 | 17 (13-24) | 0.068 | <0.001 | <0.001 | 0.232 | |
| | Alpha (degrees) | 28 | 75 (63-78.5) | 28 | 78 (75-79) | 28 | 78.5 (78-81) | 30 | 72.5 (68-78) | 0.951 | 0.072 | 0.001 | 0.001 | |
| | LI45 (%) | 28 | 100 (100-100) | 28 | 100 (99-100) | 28 | 100 (93-100) | 30 | 92.5 (85-100) | 0.012 | 0.048 | 0.016 | 0.074 | |
| | LI60 (%) | 28 | 100 (100-100) | 28 | 100 (100-100) | 28 | 100 (93-100) | 30 | 94 (95-100) | 0.018 | 0.029 | 0.011 | 0.067 | |

*The non-parametric Kruskal-Wallis test was used.

**The non-parametric Wilcoxon rank-sum (Mann-Whitney) test for pairwise comparisons was used.

Abbreviations: A10, clot strength at 10 min; A20, clot strength at 20 min; A30, clot strength at 30 min; Alpha, α angle (degrees); aPTT, activated partial thromboplastin time; CFT, clot formation time; CT, clotting time; EXTEM, extrinsically activated TEM; FIBTEM, fibrin-based extrinsically activated TEM; D-DT, international normalized ratio; D-DT4, intrinsically activated TEM; IQR, interquartile range; LI45, lysis index at 45 min; LI60, lysis index at 60 min; MCF, maximal clot firmness; PT, prothrombin time; ROTEM, rotational thromboelastometry.

Conclusions/Learning Points: ROTEM revealed a more hypercoagulable profile with hypofibrinolysis in

septic neonates. Only INTEM in the first day present a likely hypocoagulable profile in the initiate stage of clot formation. The prolongation of PT and aPTT suggest a more hypocoagulable profile during sepsis. Concerning the PT and aPTT lack in depicting cellular hemostasis model, the lack of institutional neonatal reference ranges, and that ROTEM interprets more effectively the coagulation in vivo, routine use of ROTEM may be considered.

PD153 / #1815

NEONATAL EXPOSURE TO SARS-COV-2: RISK OF TRANSMISSION AND OUTCOMES THE FIRST YEAR OF LIFE

E-Posters

POSTER DISCUSSION SESSION 10: CONGENITAL & PERINATAL AND NEONATAL INFECTIONS

Montserrat Ruiz-García¹, Maria Vinyoles Tolosa¹, Alba Costa Ramírez¹, Eudald Sellarès Casas¹, Neus Roca Saladrigues¹, Montserrat Pascual Torres¹, Anna Vilamala Bastarras², Maria Navarro Aguirre², Judith Serra-Pladevall², Duna Casadesús Cabral¹, Marta Rodríguez González¹, Maria Angels Martínez Camacho¹, Meritxell Torrabías Rodas¹

¹Hospital Universitari de Vic, Pediatrics Department, Vic, Spain, ²Hospital Universitari de Vic, Microbiology Department, Vic, Spain

Backgrounds: The impact of neonatal exposure to SARS-CoV-2 remains uncertain.

The aim of this study is to evaluate the evolution of the infants whose mothers had COVID19 during delivery.

Methods:: Observational, prospective, cohort-based study. We included healthy newborns of our center whose mother had COVID19 at delivery admission, from 03/2020 to 03/2021. Rejection of informed consent was the exclusion criteria.

We registered maternal and neonatal features, as well as the perinatal outcomes. We followed up the subjects during 12 months, registering somatometry, neurodevelopment and relevant diseases. We performed a SARS-CoV-2 RT-PCR at birth and at 15 days of life, and a blood test with blood count and SARS-CoV-2 serologies at 3, 6 and 12 months of life.

Results: We included 27 patients, with a median gestational age of 40 weeks (36.3-41.6) and a median weight-at-birth of 3025g (2200-4570). The 65.5% was born by vaginal delivery, and the 34.5% by caesarean-section (emergent on 15.3%). Apgar test was 9/10/10 on 85.1%. No resuscitation at birth, intensive care or prolonged admission were required in any case. The 81.5% of infants was exclusively breastfed. Maternal features: median age of 30.4 years (23-43), the 96% had mild COVID19 symptoms. Long-term outcomes: slight psychomotor retardation was detected on 11% (both preterm), and failure to thrive on 7.4%. Analytic results: SARS-CoV-2 RT-PCR (at birth and 15th day) was negative on 100%. Moderate neutropenia was detected at 6 months of life on 36.3%, remaining on 10%. The 18% presented IgG against SARS-CoV-2.

Conclusions/Learning Points: In our sample, there is no evidence of vertical transmission of SARS-CoV-2. Antibody transmission had low rates. All the infants had a good outcome, which lead us to conclude that COVID19 exposure has not had a relevant impact on their development.

PD154 / #1886

NEURODEVELOPMENTAL OUTCOMES FOLLOWING SHORT TERM VALGANCICLOVIR THERAPY IN CONGENITAL CYTOMEGALOVIRUS INFECTIONS

E-Posters

POSTER DISCUSSION SESSION 10: CONGENITAL & PERINATAL AND NEONATAL INFECTIONS

Lorenzo Chiusaroli¹, Gabriella Fornier², Federica De Osti³, Caterina Tiozzo⁴, Nicoletta Mainini¹

¹Neonatal Intensive Care Unit, University of Padua, Department Of Women's And Children's Health, Padua, Italy, ²Maternal fetal Infectious Diseases Unit, Treviso Regional Hospital, Treviso, Italy, ³Neonatal Intensive Care Unit, Treviso Regional Hospital, Treviso, Italy, ⁴Neonatal Intensive Care Unit, New York University, New York, United States of America

Backgrounds: Congenital cytomegalovirus (cCMV) is a major cause of neurodevelopmental deficits and non-genetic sensorineural hearing loss (SNHL). 10% of the affected newborns are symptomatic at birth and could develop over time significant neurological sequelae, including mental retardation and seizures.

Methods:: This retrospective chart review evaluated infants affected by mild cCMV and undergoing oral valganciclovir treatment. Brain magnetic resonance imaging (MRI) was performed at birth and grading central nervous system (CNS) involvement was done following Lucignani's severity score. Baseline characteristics and subsequent cognitive development (evaluated by Uzgiris-Hunt and Bayley Scales) of cCMV-infected children were recorded. Aim of the study was to compare the neurocognitive development between infants with mild central nervous system (CNS) involvement who underwent standard therapy and the ones who received shorter length of treatment.

Results: A total of 45 neonates affected by cCMV were evaluated between August 2012 and August 2021. Out of 45 patients, 18 were treated for presence of either CNS involvement or SNHL. Mild CNS involvement (grading < 2 at MRI) was detected in 6 patients: 3 patients (50%) received shorter treatment (3-8 weeks) compared to standard one due to presence of collateral effects from the therapy. None of the patients with mild CNS involvement and shorter length of therapy presented neurodevelopment deficit; moreover, no difference was found in neurological deficits between the 2 groups.

Conclusions/Learning Points: Our data suggest that cCMV children with mild CNS involvement would benefit from a shorter time treatment without developing any neurodevelopment impairment. Further studies are necessary to confirm our preliminary data.

SEROEPIDEMIOLOGY OF SARS-COV-2 IN PEDIATRIC POPULATION DURING A 16-MONTH PERIOD PRIOR TO VACCINATION

E-Posters

POSTER DISCUSSION SESSION 11: COVID CLINICAL & EPIDEMIOLOGY

Filippos Filippatos¹, Elizabeth- Barbara Tatsi², Charilaos Dellis¹, Vasiliki Efthymiou², Alexandra Margeli³, Ioannis Papassotiriou³, Vassiliki Syriopoulou¹, Athanasios Michos¹

¹National and Kapodistrian University of Athens, First Department Of Pediatrics, Infectious Diseases And Chemotherapy Research Laboratory, 'Aghia Sophia' Children's Hospital, Athens, Greece, Athens, Greece, ²National and Kapodistrian University of Athens, University Research Institute For Maternal And Child Health And Precision Medicine, Athens, Greece, Athens, Greece, ³Department of Clinical Biochemistry, "Aghia Sophia" Children's Hospital, Athens, Greece, Department Of Clinical Biochemistry, "Aghia Sophia" Children's Hospital, Athens, Greece, Athens, Greece

Backgrounds: Limited prospective serosurveillance data in children regarding SARS-CoV-2 transmission have been reported. We prospectively investigated SARS-CoV-2 seropositivity in children during a 16-month period of the COVID-19 pandemic before SARS-CoV-2 adolescents' vaccination.

Methods: Serum samples from children admitted to the major tertiary Greek pediatric hospital for any cause, except for COVID-19 infection, were randomly collected from 05/2020-08/2021. The study period was divided into four 4-month periods representing relevant epidemic waves. Total SARS-CoV-2 antibodies for nucleocapsid protein were determined using the Elecsys® Anti-SARS-CoV-2 reagent.

Results: A total of 344/3099 (11.1%) seropositive children were detected [males: 205 (59.5%); median age (IQR): 3 years (0.6-10)]. Seropositivity rates (%) increased during the four 4-month periods: 1.4%, 8.6%, 17.2%, and 17.6%, respectively (P-value<0.001). The lowest seropositivity was detected in 08/2020 (0%) and the highest were detected in 06/2021 (21.8%) and 07/2021 (21.2%). There was a correlation of seropositivity rates in children with newly diagnosed SARS-CoV-2 cases in Greece [Spearman r: 0.75(95% CI: 0.3913-0.9109; P-value: 0.001)]. No significant differences were detected between males and females. Seropositivity was significantly higher in hospitalized than in non-hospitalized children and in non-Greek compared to Greek children (P-value<0.001). The lowest seropositivity rate before school opening (9/2021) was detected in the age groups 6-12-years (14.4%) and 12-16-years (16.1%). Compared with the other age groups, the lowest median antibody titers were observed in children 0-1 year [median (IQR): 13.9 COI (4.5-53.9; P-value<0.001)].

Conclusions/Learning Points: Although the seropositivity of children was related to the community epidemic waves, the exposure was limited. Prior to the initiation of SARS-CoV-2 immunization for adolescents and younger children, the number of seropositive children is limited, which supports the need for immunization.

PD156 / #315

COVID-19 INFECTION IN PEDIATRIC PATIENTS TREATED FOR CANCER

E-Posters

POSTER DISCUSSION SESSION 11: COVID CLINICAL & EPIDEMIOLOGY

Lital Oz Alcalay¹, Sarah Elitzur^{2,3}, Nofar Amitai^{1,2}, Helen Toledano^{2,3}, Shlomit Barzilai-Birenboim^{2,3}, Gali Avrahami^{2,3}, Gil Gilad^{2,3}, Yoav Vardi⁴, Michal Dvori^{2,3}, Shai Izraeli^{2,3}, Gilat Livny^{1,2}, Oded Gilad^{2,3}

¹Schneider Children's Medical Center of Israel, Petach Tikva, Israel, A, Kaplan, Petach Tikva, Israel, ²Sackler School of Medicine, Tel Aviv University, Tel Aviv, Israel, ³Schneider Children's Medical Center of Israel, Petach Tikva, Israel, Hematology-oncology, Petach Tikva, Israel, ⁴Schneider Children's Medical Center of Israel, B, Petach Tikva, Israel

Backgrounds: ABSTRACT Background: COVID-19, the novel coronavirus, has caused a global pandemic affecting millions of people around the world. Risk factors for critical disease in adults are advanced age and underlying medical comorbidities, including cancer. Data are sparse on the effect of COVID-19 infection on pediatric patients with cancer during their active antineoplastic therapy. The optimal management of antineoplastic treatment during COVID-19 infection in this unique population is controversial. Aim: To describe the severity and clinical course of COVID-19 infection in pediatric patients with cancer during active antineoplastic treatment and to study their course of treatment.

Methods: Methods: Clinical and laboratory data were collected from medical files of patients diagnosed with COVID-19, confirmed by polymerase chain reaction (PCR), who received active antineoplastic treatment between March 2020-May 2021 in a large tertiary pediatric medical center.

Results: Results: Eighteen patients with diverse pediatric cancers are described. They were infected with COVID-19 at different stages of their antineoplastic treatment regimen. Eight had an asymptomatic COVID-19 infection, nine had mild symptoms, and one had severe disease. All of them recovered from COVID-19 infection. Two patients experienced delays in their antineoplastic treatment; none of the other patients had delays or interruptions, including patients who were symptomatic for COVID-19.

Conclusions/Learning Points: Conclusion: In pediatric patients with cancer who test positive for COVID-19, yet are asymptomatic or have mild symptoms, continuance of antineoplastic therapy may be considered.

COVID-TOES: ECOLOGIC ANALYSIS OF CHILBLAINS AND COVID-19 DIAGNOSES IN MELBOURNE, AUSTRALIA

E-Posters

POSTER DISCUSSION SESSION 11: COVID CLINICAL & EPIDEMIOLOGY

Rana Sawires^{1,2}, Michael Fahey^{3,4}, Hazel Clothier^{1,5}, Jim Buttery^{2,6,7,8,9}

¹Murdoch Children's Research Institute, Centre For Health Analytics, Parkville, Australia, ²Monash University, Faculty Of Medicine, Nursing And Health Sciences, Clayton, Australia, ³Monash Children's Hospital, Department Of Neurology, Clayton, Australia, ⁴Monash University, Neurogenetics Department, Clayton, Australia, ⁵University of Melbourne, School Of Population & Global Health, Parkville, Australia, ⁶Department of Health, Saefvic, Melbourne, Australia, ⁷University of Melbourne, Paediatrics, Melbourne, Australia, ⁸Royal Children's Hospital, Infectious Diseases/research, Melbourne, Australia, ⁹Murdoch Children's Research Institute, Centre For Health Analytics, Melbourne, Australia

Backgrounds: The global severe acute respiratory syndrome coronavirus 2 (SARS-CoV-2) pandemic has caused widespread illness and global economic disruption. In addition to the more common respiratory symptoms, cutaneous manifestations were reported in some patients with coronavirus disease 2019 (COVID-19) particularly chilblain-like skin changes. Chilblains are known to be associated with cold temperature but until COVID-19, an infectious aetiology had not been considered. While "COVID-toes" (a colloquial term for COVID-related chilblains) have been hypothesised, a strong link between COVID-19 and chilblains has proven elusive.

Methods: Using a zero-inflated negative binomial regression analysis, we successfully created a model for assessing the relationship between minimum temperature, COVID-19 infections and presentations of chilblains in a general practice (GP) setting between January 2017 and September 2021 (Figure 1).

Chilblains, COVID-19 and Minimum Temperature 2017-2021

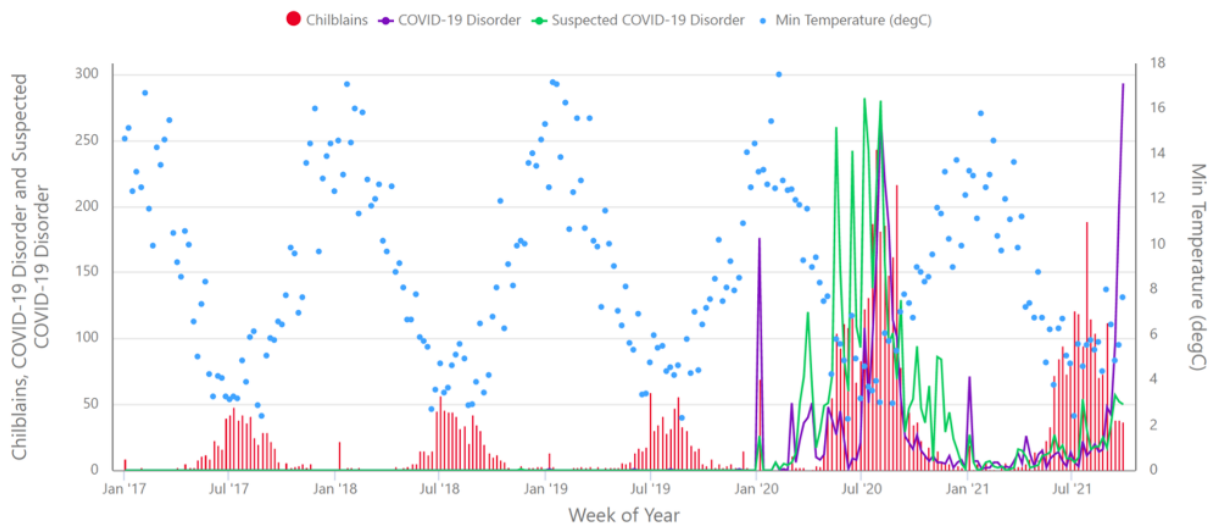

Results: After adjusting for local temperature, we found that COVID-19 diagnoses were associated with a 5.72 risk ratio (RR) of chilblain presentations, and suspected COVID-19 diagnoses were associated with a 3.23 RR. These risks were greater when analysing chilblains that occurred in 0-16-year-old children (5.96 RR and 4.34 RR respectively).

Conclusions/Learning Points: Our findings strongly support a causal relationship between COVID-19 infection and development of chilblain-like lesions and demonstrate the phenomena of chilblains being more common in children throughout the pandemic. In addition to laying the groundwork for future research into this relationship, these results aid our epidemiological understanding of COVID-19

circulation in any given region and population. Having established a temporal relationship, there are significant implications for tracking COVID-19 viral spread in the community, including predictive modelling of disease in both space and time. This can potentially reduce public health response time and inform decision-making in the midst of the ever-changing pandemic.

COMMUNITY CONTAMINATION DYNAMICS BY ANCESTRAL SARS-COV-2 IN CHILDREN AND ADULTS

E-Posters

POSTER DISCUSSION SESSION 11: COVID CLINICAL & EPIDEMIOLOGY

Anne Ploin¹, Laetitia Henaff², Antoine Ouziel³, Ellia Mezgueldi³, Chadia Toumi³, Mehdi Benchaib⁴, Marie Camphuis³, Gregory Destras⁵, Etienne Javouhey³, Bruno Lina⁶, Yves Gillet³, Jean-Sebastien Casalegno⁶, Philippe Vanhems², Dominique Ploin³

¹University of Oxford, Oxford Internet Institute, Oxford, United Kingdom, ²Hospices Civils de Lyon, Service Hygiène, Epidémiologie Et Prévention, Lyon Cedex, France, ³Hospices Civils de Lyon - Hopital Femme Mere Enfant, Service De Reanimation Et Urgences Pediatriques, Bron, France, ⁴Hospices Civils de Lyon, Service De Médecine Et De La Reproduction, Bron, France, ⁵Hospices Civils de Lyon, Laboratoire De Virologie, Lyon, France, ⁶Hospices Civils de Lyon, Institut Des Agents Infectieux - Hopital De La Croix-rousse, Lyon, France

Backgrounds: The SARS-CoV-2 pandemic disproportionately affects adults. Children seem to be more exposed to a loss regarding psychological, sociological and training/pedagogical features by preventive/control measures compared to adults. The justification for the social restriction of children, including school closures, was initially based on the influenza model, in which children are the core population of contaminators. This study investigates whether children might be the main reservoir for community SARS-CoV-2 contamination.

Methods: We matched two groups of RT-PCR+ hospitalized patients: a consecutive sample of index-children and index-adults (NOSOCOR cohort). We paired index-children's parents to similar index-adults (paired adult patients must have children; age of matched adults \approx mean age of adults living with index child ± 6 yrs) and adjusted for lockdown-related behavior before symptom onset (days of self-isolation(adult) \approx days of self-isolation(child) ± 6 d). Statistics include ratios, OR-value, 95%CI, and McNemar test.

Results: Twenty-four children were included. In these households, the first contaminators were children in 3 cases (13%), adults in 20 cases (83%), and unidentified in 1 case (4%). In 4 out of 24 cases, the first contaminated household member was a child. Out of 48 matched adults, first contaminators were children in 2 cases (4%), adults in 35 cases (73%), and unidentified in 11 cases (29%). In 2 out of 48 cases, the first contaminated household member was a child [OR (not contaminated by opposite group/contaminated by opposite group)=0.009 (95%CI: 0.001-0.51, p=0.002)].

Conclusions/Learning Points: Our study matched adult and pediatric groups to show that children were not the core source of household contamination in ancestral SARS-CoV-2 infections. Our conclusion calls for a review of severe social measures targeting children in this pandemic, although further research is needed to establish whether findings hold for variants.

PD159 / #1273

EVALUATION OF CLINICAL FEATURES OF COVID 19 IN CHILDREN WITH DIFFERENT CHRONIC DISEASES INVOLVING THE IMMUNE SYSTEM OR NOT.

E-Posters

POSTER DISCUSSION SESSION 11: COVID CLINICAL & EPIDEMIOLOGY

Alfredo Diana¹, Laura Omaggio¹, Francesco Nunziata¹, Federica Pagano², Marianna Alagia¹, Fabiola Di Dato¹, Roberta Naddei¹, Eugenia Bruzzese¹

¹University of Naples Federico II, Translational Medical Sciences - Section Of Pediatrics, Naples, Italy, ²University of Naples, Federico II, Department Of Translational Medical Sciences - Section Of Pediatrics, Naples, Italy

Backgrounds: Chronic diseases are considered a risk factor for more severe clinical course of COVID 19. We evaluated if immune dysfunction associated to the underlying chronic disease modifies the clinical course of COVID-19 in children with chronic diseases.

Methods: All patients with chronic diseases followed at Department of Paediatric of University Federico II of Naples who tested positive for COVID-19 were included. The study population was divided in two groups: children with chronic disease (endocrinologic, genetic-metabolic disorders, Cystic fibrosis and diabetes) and children with chronic disease and immune dysfunction (HIV, rheumatological and oncological disorders). All children were followed by telehealth daily and clinical symptoms, need of drugs, hospitalization, O2 support and steroid were recorded through a telephonic interview.

Results: 60 patients with chronic disease (CD) (29 male, median age 11 years) and 53 patients with secondary immune dysfunction (SID) (22 male, median age 12 years) were enrolled. Thirty-nine patients (65%) in the CD group and 30/53 (56.6%) in the SID group were symptomatic ($p=0.3$). Nine patients (15%) in CD group and 13 (24.5%) in SID group showed 3 or more symptoms ($p=0.2$). No difference in clinical symptoms, (fever 13/60 vs 20/53, $p=0.06$; headache 9/60 vs 10/53, $p=0.5$; myalgia 9/60 vs 11/53 $p=0.4$) or hospitalisation (1/60 vs 4/53, $p=0.1$) was observed between groups. No patient required intensive care. No difference in the need to change background therapy in the CD group compared to the SID group (5/60, 8% vs 3/53, 5% $p=0.5$) was recorded.

Conclusions/Learning Points: Children with chronic disease and children with chronic disease-associated immune dysfunction showed no significant difference in the clinical characteristics and outcomes of SARS-CoV2 infection, although both require close monitoring to promptly assess the need for special interventions.

PD160 / #1320

COMORBIDITIES, CLINICAL CHARACTERISTICS AND OUTCOMES OF COVID-19 IN PEDIATRIC PATIENTS IN A TERTIARY MEDICAL CENTER IN THE NETHERLANDS

E-Posters

POSTER DISCUSSION SESSION 11: COVID CLINICAL & EPIDEMIOLOGY

Amrita Biharie¹, Maya Keuning², Dasja Pajkrt³

¹Amsterdam UMC Location AMC, Pediatric Infectious Diseases, Amsterdam, Netherlands, ²Amsterdam UMC, University of Amsterdam, Department Of Pediatric Infectious Diseases, Rheumatology & Immunology, Amsterdam, Netherlands, ³Emma Children's Hospital, Pediatric Infectious Diseases, H8-253, Amsterdam, Netherlands

Backgrounds: Most currently available studies on the association between comorbidities and severity of pediatric COVID-19 describe the severity of disease based on ICU admission rates as opposed to a detailed description of clinical characteristics. Thus, this study aimed to assess the association between comorbidities, clinical characteristics and outcomes in pediatric patients with SARS-CoV-2 infections in the tertiary medical center Amsterdam UMC.

Methods: This retrospective observational cohort study describes data of patients aged 18 years or younger with a PCR or serum antibody confirmed SARS-CoV-2 infection between March 2020 and April 2021. Data were retrieved from medical records to classify acute COVID-19 and MIS-C into predefined categories describing disease severity. Subsequently, statistical analyses were performed to assess associations between comorbidities and severity.

Results: Eighty-three patients were included in this study. Out of 58 patients with acute COVID-19, 38 (65.5%) had pre-existing comorbidities. Most patients had mild disease (69.0%), while eight had severe or critical disease. Having comorbidities was found to be associated with disease severity of acute COVID-19 ($p=0.041$, OR 11.43, 95% CI 0.62 – 209.03) and ICU admission ($p=0.032$, OR =11.72, 95% CI: 0.64 – 215.29). Twenty-eight patients met the criteria for MIS-C, seven (25%) of which had pre-existing comorbidities. Twelve patients developed critical disease (42.9%). No differences in severity of MIS-C were found between those with comorbidities and those without comorbidities ($p=0.854$).

Conclusions/Learning Points: The results of this study implicate that children with comorbidities are at risk for more severe acute COVID-19. However, absolute numbers of severe pediatric COVID-19 are low. More prospective large-scale data on the susceptibility of children with comorbidities for COVID-19 is needed to establish adequate management strategies in specific groups of pediatric patients.

SEROPREVALENCE OF SARS-COV-2 INFECTION AMONG CHILDREN AND THEIR PARENTS IN GREECE

E-Posters

POSTER DISCUSSION SESSION 11: COVID CLINICAL & EPIDEMIOLOGY

Dimitra Dimopoulou¹, Maria Kyritsi², Eleni Vergadi³, Ekaterini Tsiligianni⁴, Eleni Papadimitriou⁵, Artemis Mavridi⁶, Spyridon Giannakopoulos⁷, Georgia Tsiourvopoulou⁷, Maria Palyvou⁸, Evangelia Angeli⁸, Nikitas Brikos⁹, Irini Eleftheriou¹, Nikos Spyridis¹, Athanasios Michos⁹, Vassiliki Spoulou⁹, Despoina Gkentzi⁸, Ekaterini Siomou⁷, Vassiliki Papaevangelou¹⁰, George Syrogiannopoulos⁵, Emmanouil Galanakis¹¹, Christos Hadjichristodoulou², Maria Tsolia¹

¹National and Kapodistrian University of Athens, Second University Department Of Pediatrics, "p. & A. Kyriakou" Children's Hospital Of Athens, Athens, Greece, ²University of Thessalia, Laboratory Of Hygiene And Epidemiology, Faculty Of Medicine, Larisa, Greece, ³University of Crete, Department Of Pediatrics, Heraklion, Greece, ⁴"P. & A. Kyriakou" Children's Hospital, Laboratory Of Microbiology, Athens, Greece, ⁵University of Thessalia, Department Of Pediatrics, Larissa, Greece, ⁶Attikon University Hospital, Third Department Of Pediatrics, Athens, Greece, ⁷University of Ioannina, Department Of Pediatrics, Ioannina, Greece, ⁸Patras Medical School, University of Patras, Department Of Paediatrics, Patras, Greece, ⁹"Agia Sophia" Children's Hospital, First Department Of Pediatrics, Athens, Greece, ¹⁰National and Kapodistrian University of Athens, Third Department Of Pediatrics, Attikon University Hospital, Athens, Greece, ¹¹University of Crete, Paediatrics, Heraklion, Greece

Backgrounds: School closures were enforced as measures to restrain the COVID-19 pandemic, based on the assumption that young children may play a key role in SARS-CoV-2 spread. The purpose of this study is to estimate the prevalence of SARS-CoV-2 IgG antibodies in children and a corresponding parent, to provide evidence for the potential underdiagnosis of COVID-19, in order to improve surveillance and to estimate the prevalence of asymptomatic or subclinical COVID-19 cases.

Methods: A prospective multicenter study was conducted between March and May 2021 in Greece. Pediatric patients and their parents admitted to the hospital or examined in outpatient clinics for other reasons were tested for anti-Spike SARS-CoV-2 specific IgG antibodies in serum by Chemiluminescent Magnetic Microparticle Immunoassay (CMIA). Participants with current COVID-19 infection or being vaccinated for SARS-CoV-2 were excluded. A questionnaire about clinical and demographic data was completed.

Results: This study included 329 participants: 166 children [median age:11 years (IQR:8); 87 males (52.4%)] and 163 parents [median age:43 years (IQR:9); 47 males (28.8%)]. The overall estimated SARS-CoV-2 seroprevalence was 6.7% in parents and 7.2% in children. Among 18 families with >1 child or parent with seropositivity, the combination of a seropositive parent and a corresponding seronegative child was 38.9%, the combination of a seronegative parent and a corresponding seropositive child was 33.3% and the combination of a seropositive child and a corresponding seropositive parent was 27.8%.

Conclusions/Learning Points: In this seroprevalence study, the spread of SARS-CoV-2 infection during a period of lockdown in Greece was particularly low in children and comparable to adults most likely due to intrafamilial transmission. Accordingly, it is unlikely that children have boosted virus transmission. The study findings may be useful for decisions regarding containment measures during the pandemic.

MANIFESTATIONS AND CLINICAL PHENOTYPES ARE NOT SPECIFIC ENOUGH TO PREDICT SARS-COV-2 INFECTION IN SYMPTOMATIC CHILDREN

E-Posters

POSTER DISCUSSION SESSION 11: COVID CLINICAL & EPIDEMIOLOGY

David Aguilera-Alonso¹, Elena Cobos-Carrascosa², Álvaro Ballesteros², Juan Miguel Mesa², Paula García³, Ignacio Navarro⁴, José Antonio Alonso-Cadenas⁵, Amanda Bermejo⁶, Gema Sabrido⁷, Leticia Martínez-Campos⁸, Aranzazu Flavia González-Posada⁹, Marta Illán-Ramos¹⁰, Jorge Lorente¹¹, Ana Belén Jiménez¹², Rut Del Valle⁴, Sara Domínguez¹³, Alfredo Tagarro¹³, Cinta Moraleda¹⁴

¹Hospital Gregorio Marañón, Pediatric Infectious Diseases Unit, Madrid, Spain, ²Fundación for Biomedical Research Hospital 12 de Octubre, Department Of Pediatrics, Madrid, Spain, ³Hospital Universitario La Paz, Emergency Pediatric Department, Madrid, Spain, ⁴Hospital Universitario Infanta Sofía, Department Of Pediatrics, Madrid, Spain, ⁵Hospital Infantil Universitario Niño Jesús, Emergency Pediatric Department, Madrid, Spain, ⁶Hospital Universitario de Móstoles, Pediatric Department., Madrid, Spain, ⁷Hospital Universitario Rey Juan Carlos, Pediatric Department, Madrid, Spain, ⁸Hospital Universitario Torrecárdenas, Department Of Pediatrics, Almería, Spain, ⁹Hospital Universitario 12 de Octubre, Emergency Pediatric Department, Madrid, Spain, ¹⁰Hospital Universitario Clínico San Carlos, Department Of Pediatrics, Madrid, Spain, ¹¹Hospital Gregorio Marañón, Emergency Pediatric Department, Madrid, Spain, ¹²Hospital Universitario Fundación Jiménez Díaz, Department Of Pediatrics, Madrid, Spain, ¹³Fundación for Biomedical Research Hospital 12 de Octubre, Instituto De Investigación 12 De Octubre (imas12), Madrid, Spain, ¹⁴HOSPITAL 12 DE OCTUBRE, Paediatrics, MADRID, Spain

Backgrounds: A symptom-based screening for SARS-CoV-2 diagnosis could be useful. This study aimed to analyze symptoms/signs associated with SARS-CoV-2 laboratory-confirmed infection among symptomatic children screened for COVID-19 and to define clinical phenotypes that could differentiate COVID-19 from other infections.

Methods: Cross-sectional multicenter study, nested in a prospective, observational cohort, EPICO-AEP, including children <18 years old with symptoms compatible with SARS-CoV-2 infection of ≤5 days of duration attended at the emergency departments of ten hospitals in Spain, from 2/5/2021 to 15/6/2021. SARS-CoV-2 infection was diagnosed by reverse transcription-polymerase chain reaction (RT-PCR) in nasopharyngeal swab samples. Patients were classified into two age groups (≤3 and >3 years). Two-stage factor analysis was used to define clinical phenotypes.

Results: 1,174 children were attended with symptoms compatible with COVID-19; median age 3.8 years (IQR: 1.7-9.0), 518 (44.5%) females. 68 (5.8%) had a positive SARS-CoV-2 RT-PCR: 16/516 (3.1%) if ≤3 years and 52/657 (7.9%) if >3 years. Children with COVID-19, compared to negative cases, had significantly less vomiting/nausea (p=0.005) and diarrhea (p=0.001), but more headache (p<0.001), myalgia (p<0.001) and arthralgia (p=0.037). The selected clinical phenotypes were: Lower Respiratory (dyspnea, wheezing, and chest indrawing), Upper Respiratory, (runny nose and cough), Gastrointestinal (abdominal pain, vomiting/nausea, and diarrhea), and Flu-like (arthralgia, myalgia, fatigue, headache, and sore throat). In younger children, no clinical phenotype was associated with higher odds of positive SARS-CoV-2, but in older children, Flu-like phenotype was associated with positive SARS-CoV-2 (OR: 1.84 [CI 95%: 1.09-3.11], p=0.023) and Gastrointestinal phenotype with negative SARS-CoV-2 (OR: 0.56 [CI 95%: 0.34-0.91], p=0.020)(Table 1).

Conclusions/Learning Points: Although some symptoms (headache, myalgia, and arthralgia), or phenotypes (Influenza-like in older children) were more common among children with SARS-CoV-2 infection, they are not specific enough to diagnose SARS-CoV-2 infection.

INCIDENCE OF MIS-C AND EPIDEMIOLOGY OF SARS-COV-2 INFECTION IN PEDIATRIC POPULATION FROM A NORTHERN ITALIAN REGION: A FURTHER BOOST FOR CHILDREN VACCINATION

E-Posters

POSTER DISCUSSION SESSION 12: COVID MIS-C & POST COVID

Marcello Mariani¹, Roberta Caorsi², Maura Acquila³, Giacomo Brisca⁴, Gianluca Trocchio⁵, Raffaele Spiazzi⁶, Filippo Ansaldi⁷, Camilla Sticchi⁷, Marco Gattorno², Andrea Moscatelli⁸, Angelo Ravelli⁹, Elio Castagnola¹

¹IRCCS Istituto Giannina Gaslini, Infectious Diseases And Covid Hospital, Genova, Italy, ²IRCCS Istituto Giannina Gaslini, Immunology And Inflammatory Diseases Unit, Genova, Italy, ³IRCCS Istituto Giannina Gaslini, Central Laboratory, Genova, Italy, ⁴IRCCS Istituto Giannina Gaslini, Subintensive Care Unit, Genova, Italy, ⁵IRCCS Istituto Giannina Gaslini, Cardiology, Genova, Italy, ⁶IRCCS Istituto Giannina Gaslini, Sanitary Direction, Genova, Italy, ⁷ALISA Sistema Sanitario Liguria, General Direction, Genova, Italy, ⁸IRCCS Istituto Giannina Gaslini, Intensive And Subintensive Care Unit, Genova, Italy, ⁹IRCCS Istituto Giannina Gaslini, Scientific Director, Genova, Italy

Backgrounds: The Liguria Region, Northern Italy, had 1.509.805 inhabitants as of January 1, 2021, of which 214.345 (14.2%) aged <19 years.

Methods: From March 2020 to October 2021, 112.881 SARS-CoV-2 positives were identified, of which 14.310 (12.7%) aged <19 years.

Results: From April 2020 to September 2021 28 MIS-C were diagnosed at Gaslini Institute in Genoa, regional pediatric hub for COVID-related diseases. Median age at diagnosis was 4 years (range 9 months-16 years). Median hospitalization length was 19 days (range 9-32). All patients had anti SARS-CoV-2 antibodies. Positive nasopharyngeal swab was observed in 10/28 (36%): in 8/10 cases swab was prior MIS-C onset (median 28 days, range 16-62) while in 2/10 a positive swab was identified at the onset of MIS-C. In both cases, PCR cycles were >30, probably demonstrating the final phase of an asymptomatic infection. All patients required immunosuppressive therapy with immunoglobulins, steroids or anti-interleukin-1. 4/28 patients, admitted with acute abdominal pain, underwent appendectomy. Comparing MIS-C diagnoses on Ligurian pediatric population, an incidence of 13/100,000 inhabitants <19 years is found. This is similar to post-vaccinal myocarditis described after mRNA vaccines in the same age group. On the other hand, by comparing MIS-C cases to pediatric COVID-19 positives, an incidence of about 200 /100.000 positives is found (Figure 1).

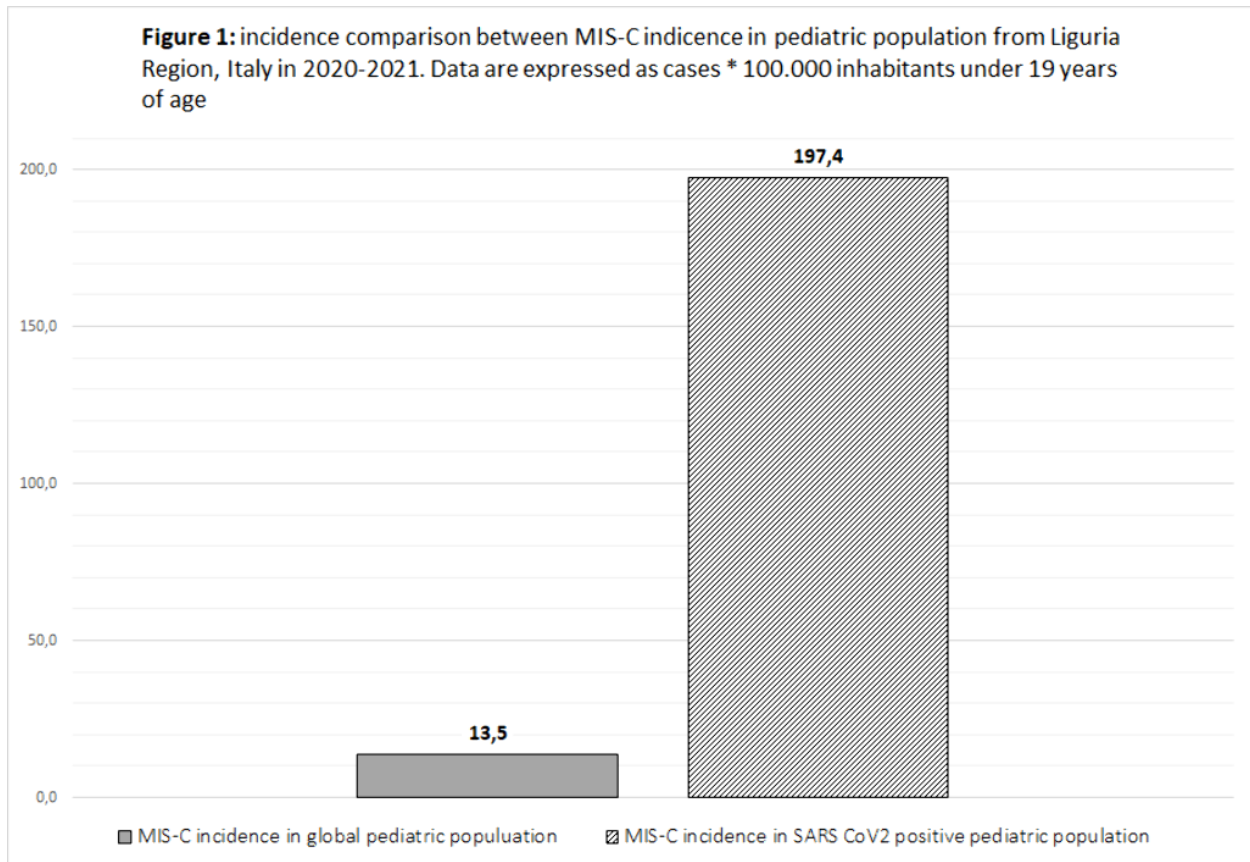

Conclusions/Learning Points: MIS-C in pediatrics is a more severe clinical syndrome than post-vaccinal myocarditis. This is supported by a higher median hospital stay (19 days for MIS-C in our case series versus 3/4 days for post vaccinal), therapies (immunosuppressive for MIS-C, symptomatic for post-vaccinal) and complications. Given these considerations and the high incidence of MIS-C in COVID pediatric population, in our opinion, the anti-SARS-CoV-2 vaccination should be actively promoted also in previously healthy children.

PD164 / #1407

POST COVID-19 CONDITION IN CHILDREN AND ADOLESCENTS: HOW ARE THE PATIENTS EVOLVING?

E-Posters

POSTER DISCUSSION SESSION 12: COVID MIS-C & POST COVID

Sara Cuso-Perez¹, Clara Carreras-Abad¹, Alba González-Aumatell¹, Èlia Domènech-Marsal¹, Paula Ventura², Maria Victoria Bovo¹, Roser Coll³, Aroia Goikoetxea³, Maria Méndez¹

¹University Hospital Germans Trias i Pujol, Autonomous University of Barcelona, Pediatric Infectious Diseases Unit, Department Of Pediatrics, Barcelona, Spain, ²HM NENS, Pediatria, Barcelona, Spain, ³University Hospital Germans Trias i Pujol, Autonomous University of Barcelona, Department Of Rehabilitation, Barcelona, Spain

Backgrounds: There is a lack of evidence of the health impact due to post COVID-19 condition among children, and especially regarding treatment. We aimed to describe the clinical characteristics and the therapeutic outcomes of children with post COVID-19 condition.

Methods: A prospective, observational, cohort study in a pediatric post COVID-19 condition multidisciplinary unit including patients <18 years old from December 2020 to July 2021. The following variables were compared before and after a 3-month rehabilitation program: presence/absence of symptoms, results of the Functional Assessment of Chronic Illness Therapy-Fatigue Scale (FATIC-F), and the 6-Minute Walk Test (6MWT) to assess performance capacity.

Results: Fifty patients were included. Median age was 14.1 (IQR: 9-17), 66% were female. In the pre-rehabilitation period, fatigue (98%), neurocognitive symptoms (74%), muscular weakness (74%), headache (72%) and dyspnea (66%) were the most reported persistent symptoms, and according to the FATIC-F test 6% had a very high degree of fatigue, 22% high, 40% moderate, 26% low and 6% no fatigue. After the rehabilitation program, dyspnea was reported as resolved in 36.4% of patients, muscular weakness in 31.7%, headache in 27.3%, fatigue in 25% and neurocognitive symptoms in 23.3%. The grade of fatigue was reduced in 62% of patients according to the Fatic-F test and 48.6% presented an improvement of at least 45 meters in the 6MWT.

Conclusions/Learning Points: This study shows the significant improvement of patients with post COVID-19 condition after a physical rehabilitation program in a short period of time. Physical recovery also showed an impact on the overall health of patients improving symptoms such as headache. However, a multidisciplinary approach is needed, including an assessment on neurocognitive rehabilitation and psychological support.

PD165 / #1501

HIGH CARDIAC TROPONIN LEVELS IN INFANTS WITH ACUTE SARS-COV-2 INFECTION NOT FULFILLING CRITERIA OF MULTISYSTEMIC INFLAMMATORY SYNDROME: A COMPARATIVE STUDY

E-Posters

POSTER DISCUSSION SESSION 12: COVID MIS-C & POST COVID

Sara Maria Scarano¹, Alfonso Maria Farina¹, Luca Pierri¹, Valentina Discepolo¹, Danilo Buonsenso², Eugenia Bruzzese¹, Alfredo Guarino¹, Andrea Lo Vecchio¹

¹University of Naples, Federico II, Department Of Translational Medical Sciences - Section Of Pediatrics, Naples, Italy, ²Fondazione Policlinico Universitario A. Gemelli IRCCS, Pediatrics, Roma, Italy

Backgrounds: COVID-19 in children has milder disease course and better prognosis than in adults. Cardiovascular system is one of the potential targets of SARS-CoV-2 infection, either in adults or children. Myocardial injury has been reported in children with multisystem inflammatory syndrome and sporadically during acute SARS-CoV-2 infection.

Methods: In order to investigate the role of SARS-CoV-2 in inducing a myocardial injury, we conducted a prospective comparative cohort study (March 25th 2020 to October 20th 2021) enrolling children <24 months hospitalized for COVID-19 (group A), acute infections other than SARS-CoV-2 (group B) compared to healthy controls (group C). The value of high-sensitivity cardiac Troponin (hs-cTn) was considered as primary outcome.

Results: Mean value of hs-cTn was significantly higher in group A (50.5 ± 136.1 pg/ml [0-1038]) than in group B (9.4 ± 30.6 [0-165]) and C (20.4 ± 17.0 [6-181]) ($p < 0.0001$). In children with COVID-19, age < 3 months was significantly associated with positive hs-cTn ($p = 0.0001$) and highest hs-cTn values (372.4 ± 397.9 pg/mL) were recorded in median 4.5 days from symptoms' onset, resulting in a 3 to 30-fold increase over local threshold. Hs-cTn levels progressively returned within the normal ranges after a median follow-up of 90 days, without clinical sings, ECG alteration or impairment of cardiac function.

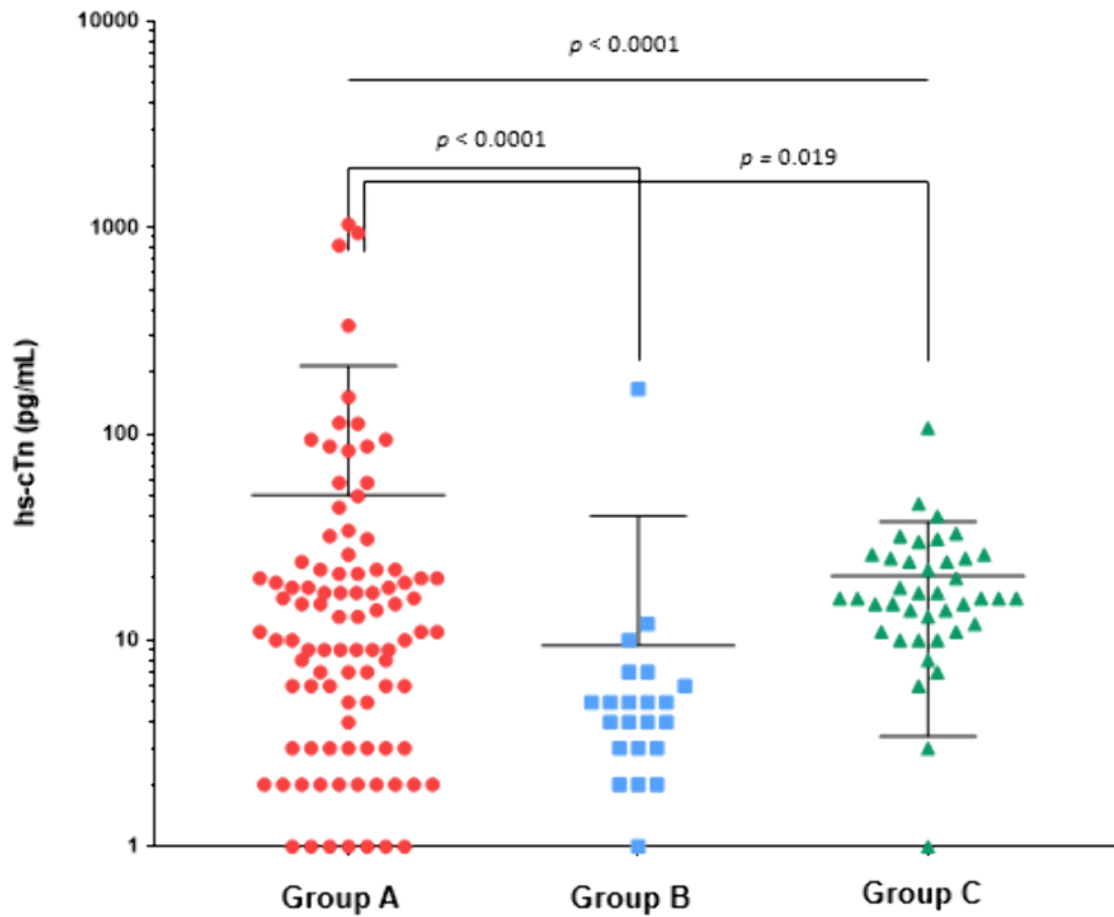

Conclusions/Learning Points: Our findings support the hypothesis that SARS-CoV-2 may have an early, probably transitory infiltration in myocardial tissue in a number of young infants with COVID-19, not fulfilling MIS-C criteria. Although the elevation of troponin was not associated with cardiac function impairment and normalized within three months of follow-up, long-term consequences are unknown and might need further assessment of longer follow-up.

PD166 / #1345

PRELIMINARY EVIDENCE ON LUNG FUNCTION AFTER ASYMPTOMATIC AND MILD COVID-19 IN CHILDREN

E-Posters

POSTER DISCUSSION SESSION 12: COVID MIS-C & POST COVID

Costanza Di Chiara, Silvia Carraro, Stefania Zanconato, Cecilia Liberati, Sandra Cozzani, Carlo Giaquinto, Valentina Agnese Ferraro, Daniele Donà
University of Padua, Department Of Women's And Children's Health, Padova, Italy

Backgrounds: Although children are largely spared from severe SARS-CoV-2 respiratory disease, it has been observed that 14% of them can show persistent respiratory symptoms after COVID-19. This study evaluated lung function (LF) in children recovered from asymptomatic or mildly symptomatic SARS-CoV-2 infection.

Methods: A single-centre, prospective, observational study was conducted on children aged 6-18 years followed up at the Department of Women's and Children's Health of Padua University Hospital. Patients were clinically evaluated by a paediatric pulmonologist and performed spirometry at a median time of 10 ± 4 months after virologically or serologically confirmed COVID-19. If airway obstruction was found at basal spirometry, a bronchodilator reversibility test was carried out. Subjects with pre-existing chronic lung disease were excluded.

Results: From August 2021 to November 2021, we enrolled 61 children (52.5% females) with a mean age of 10.9 ± 2.9 years. Thirty-seven patients (60.7%) were mildly symptomatic during the acute phase, and the remaining were asymptomatic. After COVID-19, none of the patients reported any persistent respiratory symptoms or needed any inhaled therapy (e.g. bronchodilator, steroids), both at rest and after physical activities. At spirometry, all patients had normal values of FEV1, FVC, FEV1/FVC, and FEF25/75, analyzed using Z-scores according to reference values of the Global Lung Function Initiative powered by the European Respiratory Society. Moreover, four children underwent a bronchodilator reversibility test, but none of them had a significant increase in FEV1.

Conclusions/Learning Points: We investigated for the first time the long-term impact of SARS-CoV-2 on LF in children and adolescents affected by asymptomatic or mild COVID-19. All children remained asymptomatic and with normal spirometric values up to 12 months after infection. Further studies are encouraged to investigate the risk of post-infection lung sequelae in children after severe COVID-19 pneumonia.

MULTISYSTEM INFLAMMATORY SYNDROME IN CHILDREN (MIS-C) IN THE REPUBLIC OF IRELAND FOLLOWS COVID-19 SURGES IN THE COMMUNITY IRRESPECTIVE OF SCHOOL OR CHILDCARE FACILITY CLOSURES.

E-Posters

POSTER DISCUSSION SESSION 12: COVID MIS-C & POST COVID

Bryony Treston¹, Naomi Petty-Saphon², Abigail Collins³, Sarah Murray⁴, Aoife Colgan², Eoin Fitzgerald⁵, Mahmoud Hassan⁵, Karina Forde¹, Niall Linnane⁶, Patrick Gavin¹
¹CHI Crumlin, Department Of Infectious Diseases And Immunology, Dublin, Ireland, ²HSE, Health Protection Surveillance Centre, Dublin, Ireland, ³HSE, Child Health Public Health, Tullamore, Ireland, ⁴HSE, Public Health, Dublin, Ireland, ⁵Children's Health Ireland at Temple Street, Paediatric Infectious Diseases And Immunology, Dublin, Ireland, ⁶Children's Health Ireland at Crumlin, Paediatric Cardiology, Dublin, Ireland

Backgrounds: MIS-C has emerged as the most clinically significant manifestation of SARS-Co-2 infection in children. We describe the epidemiology of MIS-C in children in the Republic of Ireland during the first year of the SARS-CoV-2 pandemic (April 2020 - April 2021).

Methods: Data collected included: clinical characteristics; treatment; outcome; incidence; geographic location; contact tracing; and deprivation score. MIS-C case definition was that proposed by RCPCH.

Results: 63 children were treated for MIS-C. Ten cases were subsequently excluded because of an alternative diagnosis. Of 54 children with confirmed MIS-C, 34 were of inflammatory type and 20 of Kawasaki Disease (KD) type. Median age was 7.58 years (range, 0.3 to 15y). MIS-C incidence was increased in children of Black African (9.3%) and Non-Chinese Asian (7.4%) ethnicity. All cases were otherwise healthy, however, 44% were obese (>90th centile). At presentation, gastrointestinal symptoms (59%) were more common than respiratory (20%). Median length of hospital stay was 7.5days. 30% required PICU admission. All patients made a complete recovery. There were no fatalities. Incidence of MIS-C was closely associated with surges of COVID-19 in the community irrespective of periods of school and childcare facility closures/openings. No association was found with school outbreaks. Half the cases (19 of 38) were SARS-COV-2 seropositive (hyperinflammatory-type, 69%; KD-type, 8%). 22% of MIS-C cases had recent SARS-COV-2 infection, and 46% had close contact (most commonly household) with a SARS-COV-2 infected individual. Deprivation scores of MIS-C case households changed from more affluent to more disadvantaged areas over the study-period.

Conclusions/Learning Points: Our findings suggest efforts aimed at controlling SARS-CoV-2 transmission in the community are a more effective means to reduce MIS-C cases than closure of childcare facilities and schools.

MULTISYSTEM INFLAMMATORY SYNDROME IN CHILDREN (MIS-C): A NATIONWIDE COLLABORATIVE STUDY IN THE GREEK POPULATION

E-Posters

POSTER DISCUSSION SESSION 12: COVID MIS-C & POST COVID

Stavroula Lampidi¹, Despoina Maritsi¹, Irimi Eleftheriou¹, Evaggelia Farmaki², Nikos Spyridis¹, Konstantina Charisi³, Petrina Vantsi³, Filippos Filippatos⁴, Kleopatra Skourti⁴, Efimia Papadopoulou-Alataki⁵, Kyriaki Papadopoulou-Legbelou⁶, Parthena Kampouridou⁶, Ioanna Grivea⁷, Eleni Vergadi⁸, Despoina Gkentzi⁹, Despina Dimou¹⁰, Patra Koletsi¹⁰, Lampros Fotis¹¹, Vassiliki Papaevangelou¹¹, Gabriel Dimitriou⁹, Emmanouil Galanakis⁸, George Syrogiannopoulos⁷, Vassiliki Spoulou⁴, Athanasios Michos⁴, Emmanuel Roilides³, Maria Tsolia¹

¹National and Kapodistrian University of Athens, Second Department Of Pediatrics, "p. & A. Kyriakou" Children's Hospital, Athens, Greece, ²Aristotle University of Thessaloniki, 1st Department Of Pediatrics, Thessaloniki, Greece, ³Aristotle University of Thessaloniki, Third Department Of Paediatrics, Hippokraton General Hospital, Thessaloniki, Greece, ⁴National and Kapodistrian University of Athens, First Department Of Paediatrics, 'aghia Sophia' Children's Hospital, Athens, Greece, ⁵Aristotle University of Thessaloniki, Fourth Department Of Pediatrics, Papageorgiou General Hospital, Thessaloniki, Greece, ⁶Genimatas General Hospital, Pediatric Department, Thessaloniki, Greece, ⁷Faculty of Medicine, School of Health Sciences, University of Thessaly, Department Of Pediatrics, Larissa, Greece, ⁸Medical School, University of Crete, Department Of Paediatrics, Heraklion, Greece, ⁹Patras Medical School, University General Hospital of Patras, Department Of Paediatrics, Patras, Greece, ¹⁰Penteli Children's Hospital, Department Of Paediatrics, Athens, Greece, ¹¹National and Kapodistrian University of Athens, Third Department Of Paediatrics, General University Hospital "attikon", Athens, Greece

Backgrounds: The multisystem inflammatory syndrome in children (MIS-C) is a rare but severe hyperinflammatory condition that may occur following SARS-CoV-2 infection.

Methods: This is a retrospective, descriptive study of patients hospitalized with MIS-C in 10 tertiary care centers in Greece until December 31st, 2021. Demographics, clinical and laboratory characteristics, treatment and outcome are described.

Results: 119 patients (78 males, median age 8.4 years, IQR 4.5-13.5) were included and 109/119 met the criteria of the WHO case definition of MIS-C while 105/119 (88.2%) had serological evidence of SARS-CoV-2 infection. Of the 119 patients, fever was present in 99.2%, gastrointestinal symptoms in 79%, mucocutaneous involvement in 64% and respiratory symptoms in 32%. Forty-five patients (38%) developed myocarditis, 26 (22%) pericarditis and 7 (6%) coronary aneurysms. In the above cases 8/45 (17.7%), 1/26 (3.8%) and 3/7 (42.8%) respectively, cardiac complications had not fully resolved at discharge. Underlying comorbidities were reported in 22/119 (18.5%) patients. Median CRP, ferritin and WBC values were 134mg/L (IQR, 30.9-228), 453ng/ml (IQR, 275.5-987.3) and 14.080/mm³ (IQR, 9495-20305), respectively. The majority of patients had elevated troponin (82/119, 68.9%) and/or pro-BNP (53/119, 44.5%). Intravenous immunoglobulin and/or corticosteroids were used in 101/119 (85%) whereas anti-IL1 treatment was added in 9/119 (7.6%). 25 patients (21%) were admitted to the ICU, 13 (10.9%) developed shock and one (0.8%) patient required ECMO. Mortality rate was 0.9%. The incidence of MIS-C was estimated at 0.64/1000 SARS-CoV-2 infections.

Conclusions/Learning Points: MIS-C is a novel, infrequent but serious disease entity. Most common cardiac manifestations included myocarditis and pericarditis, which resolved in the majority of our patients. Immunomodulatory therapy was shown to be effective however residual cardiac involvement remains an issue. Further research is required to elucidate the pathogenesis, risk factors and optimal management.

EPIDEMIOLOGICAL AND CLINICAL CHARACTERISTICS OF THE MULTISYSTEM INFLAMMATORY SYNDROME ASSOCIATED WITH SARS-COV-2 INFECTION IN CHILDREN (MIS-C) IN CATALONIA (SPAIN): AN OBSERVATIONAL AMBISPECTIVE MULTICENTRIC STUDY.

E-Posters

POSTER DISCUSSION SESSION 12: COVID MIS-C & POST COVID

Maria Coma-Calle¹, Aida Perramon², Marc García-Lorenzo³, Rosa Pino⁴, Jaques G. Rivière^{5,6}, Núria Visa-Reñé⁷, Abel Martínez-Mejias⁸, Antoni Soriano-Arandes^{5,6}, Clara Prats², Juan José García-García⁹, Borja Guarch¹⁰, Núria López Segura¹¹, Anton Foguet¹², Romina Conti¹³, Montserrat Ruiz-García¹⁴, Isabel Aguilar¹⁵, Sònia Brió¹⁶, Teresa Fenollosa¹⁷, Anna Gatell¹⁸, Carlos Herrero¹⁹, Zulema Lobato²⁰, Emiliano Mora²¹, Francesc Ripoll²², Pere Soler-Palacín^{5,6}, Fernando Paredes-Carmona⁷
¹Hospital Joan XXIII de Tarragona, Pediatrics Department, Tarragona, Spain, ²Universitat Politècnica de Catalunya, Department Of Physics, Barcelona, Spain, ³Hospital Universitari Sant Joan de Reus, Paediatrics Department, Reus, Spain, ⁴Hospital Sant Joan de Déu, Pediatrics Department, Esplugues de Llobregat, Spain, ⁵Vall d'Hebron Research Institute (VHIR), Pediatrics Infectious Diseases, Barcelona, Spain, ⁶Hospital Universitari Vall d'Hebron (HUVH), Pediatric Infectious Diseases And Immunodeficiencies Unit, Barcelona, Spain, ⁷Hospital Universitari Arnau de Vilanova, Pediatrics Department, Lleida, Spain, ⁸Consorti Sanitari de Terrassa, Pediatrics Department, Terrassa, Spain, ⁹Hospital Sant Joan de Déu, Head Of Pediatrics Department, Esplugues de Llobregat, Spain, ¹⁰Hospital Universitari de Girona Dr. Josep Trueta, Pediatrics Department, Girona, Spain, ¹¹Hospital del Mar, Pediatrics Department, Barcelona, Spain, ¹²Equip Pediàtric Territorial de la Garrotxa, Institut Català De La Salut (ics), Olot, Spain, ¹³Consorti Sanitari Parc Taulí, Paediatrics, Sabadell, Spain, ¹⁴Hospital Universitari de Vic, Pediatrics Department, Vic, Spain, ¹⁵Centre d'Atenció Primària Camps Blancs, Institut Català De La Salut (ics), Sant Boi de Llobregat, Spain, ¹⁶Hospital de la Santa Creu i Sant Pau, Pediatrics Department, Barcelona, Spain, ¹⁷Centre d'Atenció Primària Gran Sol, Institut Català De La Salut (ics), Badalona, Spain, ¹⁸Equip Pediatria Territorial Alt Penedès-Garraf, Institut Català De La Salut (ics), Sant Pere de Ribes, Spain, ¹⁹Hospital de Barcelona, Pediatrics Department, Barcelona, Spain, ²⁰Althaia. Xarxa Assistencial Universitària de Manresa, Pediatrics Department, Manresa, Spain, ²¹Hospital Universitari Mútua de Terrassa, Pediatrics Department, Terrassa, Spain, ²²Hospital de Santa Caterina, Pediatrics Department, Salt, Spain

Backgrounds: MIS-C is a rare but severe SARS-CoV-2 temporarily related disease. We estimated the MIS-C prevalence (cases per 100,000 persons), incidence (cases per 100,000 SARS-CoV-2 infections), and clinical characteristics of all consecutive MIS-C in individuals <18 years in Catalonia (Spain).

Methods: Multicentric ambispective observational study (April 2020-December 2021). Epidemiological and clinical data were obtained from the COVID-19 Catalan surveillance system and medical records of all the health-care centers of Catalonia included in the COPEDI-CAT project. Total population <18 years in Catalonia is 1,384,382.

Results: Among 203,854 SARS-CoV-2 infections in this age-group, 105 children were diagnosed. MIS-C prevalence was 7.6 (95%CI: 6.1-9.0) per 100,000 persons, and incidence 51.5 (95%CI: 41.6-61.3) per 100,000 SARS-CoV-2 infections (figure). Median [IQR] age was 12 [6-17] years, 57.8% male, 80.2% without comorbidities. COVID-19 was previously diagnosed in 41.8%, mostly asymptomatic. SARS-CoV-2 IgG and PCR tested positive in 94/103 (91.3%) and 26/97 (26.8%), respectively. High-fever (97.0%), gastrointestinal symptoms (87.1%), skin rash (62.0%), and fatigue/malaise (61.4%) were the most common findings. Echocardiography was abnormal in 40.6%, 57 (54.3%) had shock signs, 30 (28.6%) needed inotropic support, 9 (8.6%) mechanical ventilation, and 1 (0.9%) ECMO. None of them died.

Catalonia

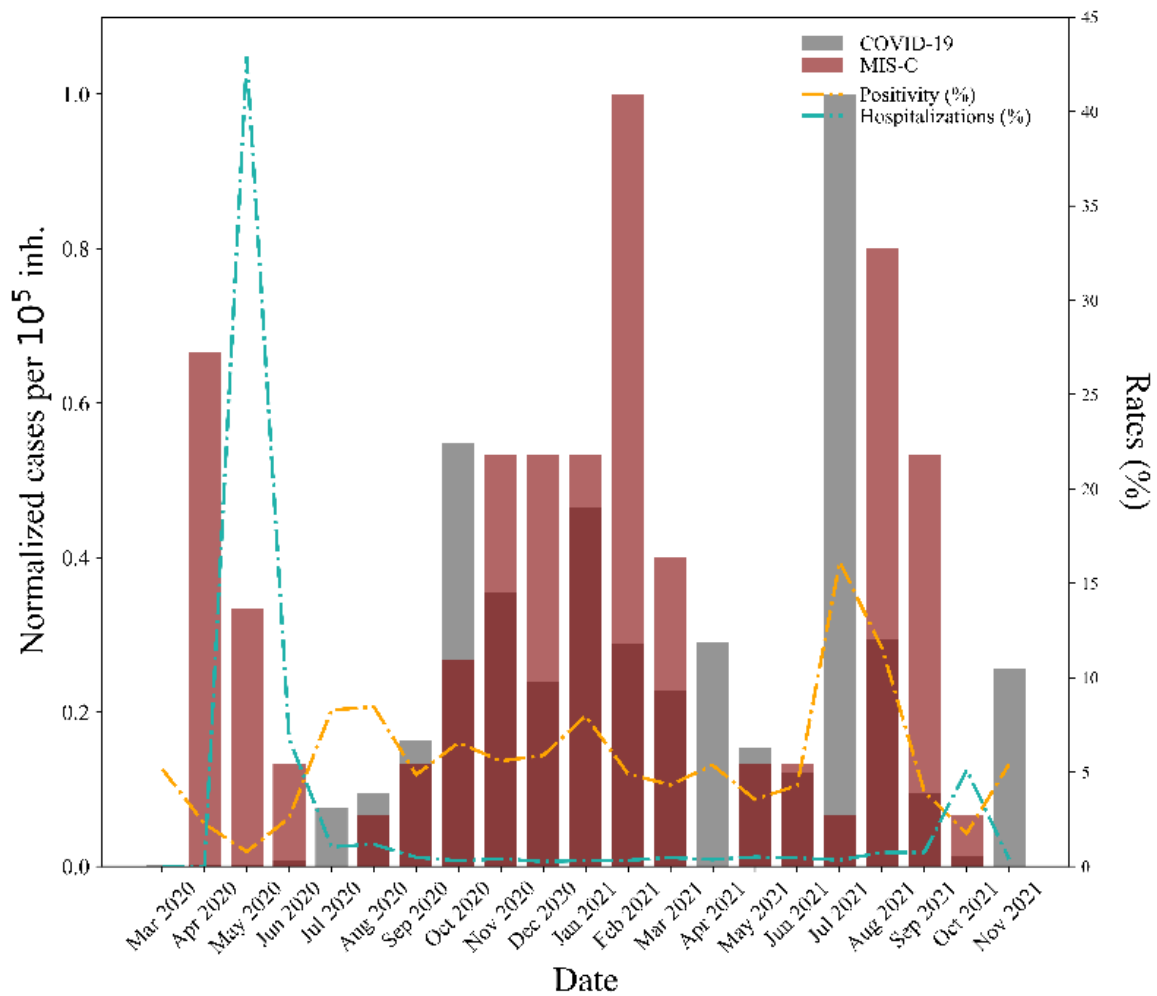

Conclusions/Learning Points: This is one of the largest MIS-C case-series studies in Europe. We were able to estimate the main epidemiological and clinical characteristics of MIS-C in Catalonia due to the transversality, from primary care to tertiary hospitals, of our network. MIS-C prevalence was 7.6 (95%CI: 6.1-9.0) per 100,000 persons, and incidence 51.5 (95%CI: 41.6-61.3) per 100,000 SARS-CoV-2 infections.

SYMPTOM PROFILES IN CHILDREN WITH POST-COVID SYNDROME IN DIFFERENT AGE GROUPS

E-Posters

POSTER DISCUSSION SESSION 12: COVID MIS-C & POST COVID

Coen R. Lap¹, Lieke C.E. Noij^{2,3}, Giske Biesbroek⁴, Lisanne Van Leeuwen^{1,5}, Kim Oostrom⁶, Mattijs W. Alsem⁷, Simone Hashimoto², Marlies A. Van Houten¹, Suzanne W.J. Terheggen-Lagro²

¹Spaarne Gasthuis, Science Institute Vaccine, Infection And Immunology, Hoofddorp, Netherlands, ²Emma Children's hospital, Department Of Pediatric Pulmonology And Allergy, Amsterdam, Netherlands, ³Amsterdam UMC, Department Of Respiratory Disease, Amsterdam, Netherlands, ⁴Amsterdam UMC, Immunology, Rheumatology And Infectious Diseases, Amsterdam, Netherlands, ⁵Leiden University Medical Center, Pediatrics, Leiden, Netherlands, ⁶Amsterdam University Medical Centre, Paediatric Psychosocial Care, Amsterdam, Netherlands, ⁷Amsterdam UMC, Department Of Child Rehabilitation, Amsterdam, Netherlands

Backgrounds: SARS-CoV-2 infected children can suffer from persistent complaints, collectively called post-COVID syndrome. The first international studies report a prevalence of 1,3- 4% of post-COVID complaints in children. Children referred to Pediatric Clinics experience severe limitations in daily functioning. Only little is known about the presenting symptoms and symptom profiles in different age groups although this would enable recognition of the syndrome and phenotyping of patients. We therefore aimed to study the symptom profiles in children with post-COVID syndrome in different age-groups.

Methods: In this cross-sectional ongoing study we include young children (4-11 years) and adolescents (12-18 years) referred to the post-COVID clinic from an academic hospital in Amsterdam. Children participated if symptoms were present for at least 3 months and no longer than 12 months after SARS-CoV-2 infection. Complaints were documented by symptom questionnaires at presentation in the clinic.

Results: We included 14 young children (50% male, 7.9 ± 2.2 years) and 60 adolescents (32% male, 15.2 ± 1.5 years). In both age-groups there was a severe to very severe limitation in daily functioning (28.5% and 26.6%, respectively) and physical activities (85.7% and 78.3%), the most prevalent presenting symptoms were fatigue (100% and 88.3%), headache (57% and 50%) and difficulty concentrating (43% and 62%). Children < 12 years of age presented more often with recurrent fever episodes (43% and 8,3%) and abdominal pain (57% and 17%), whereas adolescents more often experienced cardiac palpitations (7.1% and 37%), dyspnea (14.2% and 52%) and dizziness (7.1% and 23,3%).

Conclusions/Learning Points: These preliminary results suggests differences in symptom profiles in children under and above 12 years of age. This study aids in better recognition and phenotyping children with post-COVID syndrome.

PD171 / #1321

TWELVE MONTHS MULTIDISCIPLINARY FOLLOW UP OF PATIENTS WITH PEDIATRIC INFLAMMATORY MULTYSYSTEMIC SYNDROME IN A CHILDREN'S HOSPITAL IN CHILE

E-Posters

POSTER DISCUSSION SESSION 12: COVID MIS-C & POST COVID

Cecilia Pinera^{1,2}, Sofia De La Barra², Aracely Barrueto², Alejandra Arape³, Gabriel Bittner³, Giannina Izquierdo^{1,2}

¹Hospital Exequiel Gonzalez Cortés, Infectious Disease Unit, San Miguel, Chile, ²Facultad de Medicina Universidad de Chile, Departamento Pediatría Y Cirugía Infantil Sur, San Miguel, Chile, ³Hospital Exequiel Gonzalez Cortés, Cardiology Unit, San Miguel, Chile

Backgrounds: Multisystem inflammatory Syndrome (MIS-C) is a new severe postinfectious condition seen in children during the COVID-19 pandemic. We still do not know its consequences in the short, medium, and long term. **OBJECTIVE:** To describe clinical, laboratory, and echocardiographic outcomes after 12 months of follow-up of children after MIS-C.

Methods: A prospective cohort study of children who fulfilled the WHO criteria for MIS-C and were admitted to a Children's Hospital between June 1st, 2020, and June 30, 2021. Patients were followed up by a multidisciplinary team at 2, 6 weeks, 3, 6, and 12 months. Clinical, laboratory, and echocardiographic outcomes were analyzed during the acute and follow-up phase.

Results: 52 patients fulfilled SIM-C criteria; 37 (71%) of them completed 12 months follow-up. Median age 5y 10m. 54% girls. During acute phase, 35% had a positive SARS-CoV-2 PCR, 86% positive serology, and 71% epidemiological link. 46% had an abnormal echocardiogram (65% coronary alterations). 54% with shock. Median length of hospitalization was 7,5 days, without mortality. During follow-up, one patient was readmitted. CBC and CRP normalized at 14 days, ESR at 3 months, Echocardiographic alterations were resolved in 83% patients at 6 weeks, and in all patients at 6 months, remaining normal at 12 months. We observed 39% patients with mental health diagnoses and an increase of obesity from 52 to 67% of patients. At 12 months, 96% of the cohort had a positive COVID-19 Serology.

Conclusions/Learning Points: SIM-C, despite being a serious disease in children, presents a fast resolution of clinical, laboratory, and echocardiographic alterations. A follow-up of at least 6 months is required.

PD172 / #1391

IMPACT OF POST COVID-19 CONDITION ON CHILDREN: A PROSPECTIVE, OBSERVATIONAL, COHORT STUDY

E-Posters

POSTER DISCUSSION SESSION 12: COVID MIS-C & POST COVID

Sara Cuso-Perez¹, Clara Carreras-Abad¹, Alba González-Aumatell¹, Maria Victoria Bovo¹, Èlia Domènech-Marsal¹, Paula Ventura², Maria Méndez¹

¹University Hospital Germans Trias i Pujol, Autonomous University of Barcelona, Pediatric Infectious Diseases Unit, Department Of Pediatrics, Barcelona, Spain, ²HM NENS, Pediatria, Barcelona, Spain

Backgrounds: Currently there is a lack of evidence of the health impact due to the post COVID-19 condition among children. We aimed to investigate the academic, social, and health impact of post COVID-19 condition in children.

Methods: A prospective, observational, cohort study at a “Pediatric post COVID-19 condition Multidisciplinary Unit” including patients <18 years old between December 2020 and May 2021. Demographic data, medical history, SARS-CoV-2 infection diagnosis, persistent symptoms and their impact on daily activities were collected; a physical examination, blood test, electrocardiogram, chest radiography, and diaphragmatic ultrasound were also performed. Functional Assessment of Chronic Illness Therapy-Fatigue scale (FACIT-F) was used to classify self-reported fatigue and “Pediatric Symptom Checklist” (PSC) to evaluate mental health.

Results: Fifty patients with post COVID-19 condition were included. The median age was 14.1 years (IQR: 12.2-15.8), 66% were female, and 34% had a relative diagnosed with post COVID-19 condition. Persistence of symptoms at diagnosis were 4.1 months (IQR: 2.9-10.3). Fatigue (98%), neurocognitive symptoms (74%), muscular weakness (74%), headache (72%), dyspnea (66%), and myalgia (64%) were the most reported persistent symptoms. 70% experienced high to moderate fatigue. Physical and neurocognitive rehabilitation programs were offered. 30% obtained a positive score on the PSC. 42% were referred to a mental health professional. Schooling was disrupted in 52%, 68% could not do their usual extracurricular activities.

Conclusions/Learning Points: Our study reflects that besides the normality of the physical exam and complementary tests, there is a major repercussion on children's health, academic and social life in these fundamental periods of life. Post COVID-19 condition brings significant suffering in children and their families. This evidences the need for a multidisciplinary approach. Further research in this field is needed.

BRAIN DIFFERENCES IN ADOLESCENTS WITH PERINATALLY ACQUIRED HIV COMPARED TO ADOPTION STATUS MATCHED CONTROLS: A CROSS-SECTIONAL MAGNETIC RESONANCE IMAGING STUDY

E-Posters

POSTER DISCUSSION SESSION 13: PUBLIC HEALTH & HIV

Jason Van Genderen¹, Cecilia Chia¹, Malon Van Den Hof¹, Henk Mutsaerts², Liesbeth Reneman³, Dasja Pajkrt¹, Anouk Schrantee³

¹Emma Children's Hospital, Pediatric Infectious Diseases, H8-253, Amsterdam, Netherlands, ²Amsterdam UMC, location VUmc, Department Of Radiology And Nuclear Medicine, Amsterdam, Netherlands, ³Amsterdam UMC, location AMC, Department Of Radiology And Nuclear Medicine, Amsterdam, Netherlands

Backgrounds: Despite effective treatment, adolescents with perinatally acquired HIV (PHIV) exhibit neurological changes, including lower brain volumes, more white matter (WM) hyperintensities (WMH) volume, lower WM integrity, and differences in cerebral blood flow (CBF). However, this group is frequently adopted, which may have confounded these results, as the effects of early life events associated with adoption status remain largely unknown. To this purpose, we compared MRI outcomes of PHIV adolescents with HIV-negative status controls matched for age, sex, ethnic origin, socio-economic and adoption status.

Methods: We determined whole brain gray matter (GM) and WM volume with 3D-T1-weighted scans; total WMH volume with fluid-attenuated inversion recovery; CBF in the following regions of interest (ROIs): WM, GM and subcortical GM with arterial spin labeling; and whole brain WM microstructural markers: fractional anisotropy (FA), mean diffusivity (MD), axial diffusivity (AD), radial diffusivity (RD) with diffusion tensor imaging in 35 treated PHIV adolescents and 38 controls. We assessed differences in neuroimaging parameters between PHIV adolescents and controls using linear regression models adjusted for age and sex.

Results: At enrollment, the median age (years) of PHIV adolescents was 14.9 (IQR: 10.7-18.5) and of controls 15.6 (IQR:11.1-17.6). We found a lower FA (beta = -0.012; p<0.001, -2.4%), higher MD (beta = 0.014, p = 0.003, 1.3%) and higher RD (beta = 0.02, p = 0.002, 3.3%) in PHIV adolescents vs. controls, but no differences in AD. We found no significant differences in total GM, WM and WMH volume and CBF in ROIs between groups. We found no association between IQ and WM microstructural markers in PHIV adolescents.

Conclusions/Learning Points: Irrespective of adoption status, PHIV adolescents exhibited subtle lower WM integrity. Our findings may point towards early-acquired HIV-associated WM microstructural alterations.

IMMUNOGENICITY OF CONJUGATE MENINGOCOCCAL ACWY-TT VACCINE IN CHILDREN AND ADOLESCENTS LIVING WITH HIV

E-Posters

POSTER DISCUSSION SESSION 13: PUBLIC HEALTH & HIV

Arantxa Berzosa¹, Sara Guillén², Cristina Epalza³, Luis Escosa-García⁴, Maria Luisa Navarro⁵, Luis Prieto⁶, Talia Sainz⁷, Santiago Jimenez De Ory⁵, Marta Illán-Ramos¹, Raquel Abad⁸, Jose Tomas Ramos Amador¹

¹Clínico San Carlos Hospital, Paediatrics, Madrid, Spain, ²Hospital Getafe, Pediatrics, Madrid, Spain, ³Hospital 12 Octubre, Pediatrics, Madrid, Spain, ⁴Hospital Universitario La Paz, Paediatric Infectious Diseases Unit, Department Of Paediatrics, Madrid, Spain, ⁵Hospital Gregorio Marañón, Pediatrics, MADRID, Spain, ⁶HOSPITAL 12 DE OCTUBRE, Paediatrics, MADRID, Spain, ⁷La Paz University Hospital, Pediatrics And Infectious Diseases, Madrid, Spain, ⁸Centrol Nacional Microbiología, Microbiología, Madrid, Spain

Backgrounds: HIV-infected patients are at increased risk of meningococcal infection. Conjugate meningococcal vaccines are recommended, but no studies have been conducted on the immunogenicity of MenACWY-TT in HIV-infected adolescents. Since HIV-infected adolescents may have impaired vaccine response, a two dose booster schedule might be needed.

Methods: Prospective observational study conducted in HIV-infected adolescents in Madrid with the administration of 2 doses of MenACWY-TT(2 months apart) and the assessment of serum bactericidal antibodies (SBA) assays using rabbit complement. Sera were scheduled to be assessed at baseline, one month and 10 months after second dose. A threshold of hSBA titres of >1:8 against C, W-135 and Y groups was considered protective. Vaccine response was defined as a postvaccination SBA titre of >1:32 in initially seronegative subjects (<1:8) and a 4-fold increase in titre from pre- to post-vaccination in initially seropositive subjects (>1:8). Most patients had been previously immunized with a primary series of MenC conjugate vaccine in the first year of life.

Results: Twenty-eight HIV-infected adolescents were included (characteristics on figure 1). Overall, 7(25%), 7(25%) and 8(28.6%) patients had baseline protective antibodies against capsular groups C,W-135 and Y, respectively. Most patients 21(75%) showed vaccine response to all vaccine serogroups. One month postvaccination, 20(71.4%) previously seronegative patients had hSBA titre >1:32 for each serogroup. Among initially seropositive patients, 4/7 had a 4-fold increase in hSBA titre against C, 4/7 against W-135 and 5/8 against Y group. After the second vaccine dose, the proportions achieving titres >1:1024 to groups C, W-135 and Y, were 9(32.1%), 21(75%) and 24(85.7%).

Figure 1. Characteristics of patients included

| | |
|---|---------------------------|
| Total patients: 28 | |
| Epidemiological | |
| Female | 16 (57%) |
| Age (years) * | 17.1 years (11.4 - 21.6) |
| Perinatally infected | 21 (75%) |
| Clinical | |
| C or 3 CDC-class | 5 (18%) |
| Inmunovirological status | |
| CD4+ Nadir * | 446 cells/ml (333 - 644) |
| Baseline CD4+ count * | 892 cells/ml (658 - 1034) |
| Undetectable viral load (<50 copies/ml) | 26 (93%) |
| Treatment | |
| On ART | 28 (100%) |

* median (IQR)

Conclusions/Learning Points: HIV-infected adolescents with good immuno-virological status achieve appropriate antibody-mediated protection against serogroups C,W and Y after 2 booster doses of MenACWY-TT. Response at 12 months is under evaluation.

PD175 / #1251

RETROSPECTIVE ANALYSIS OF THE FRENCH NATIONAL HEALTH INFORMATION SYSTEM (SNDS): TO ASSESS THE SUBSTANTIAL BURDEN OF INVASIVE MENINGOCOCCAL DISEASE AND SOCIOECONOMIC IMPACT

E-Posters

POSTER DISCUSSION SESSION 13: PUBLIC HEALTH & HIV

Catherine Weil-Olivier¹, Muhamed-Kheir Taha², Veronique Loncle-Provot³, Ekkehard Beck⁴, Emmanuel Aris⁴, Corinne Emery⁵, Emmanuel Bouee⁵, Gaelle Nachbaur⁶, Céline Pribil³

¹Honorary professor of pediatrics, Université Paris 7, Pediatrics, Paris, France, ²Institut Pasteur, Invasive Bacterial Infections, Paris, France, ³GSK, Gsk, Paris, France, ⁴GSK, Gsk, Wavre, Belgium, ⁵Cemka, Cemka, Bourg-La-Reine, France, ⁶GSK, Gsk, Rueil-Malmaison, France

Backgrounds: Invasive meningococcal disease (IMD) is a devastating life-threatening disease, where the socioeconomic burden is poorly characterized and limited by research. This case-controlled study provides a retrospective analysis from the French National Health Information System (SNDS) to assess the care-pathway of IMD patients in France before, during and after hospitalization and the impact of IMD on life expectancy and socioeconomic burden for financial state dependency following the IMD acute phase.

Methods: All hospitalized acute IMD patients, any age in France (between 2012 and 2017) and matched controls (adjusted for age, gender and region) were analyzed. Preexisting medical (i.e. immunodeficiency) or socioeconomic (i.e. insurance status and social deprivation) risks factors were characterized along with assessment of patient care pathway before, during, and post hospital-discharge. The sequelae were identified in short and long term. Mortality rate, respective life expectancy and financial state dependency was calculated post-hospitalization and extrapolated over lifetime.

Results: Overall, 3,532 cases and 10,590 matched controls were identified (mean age: 29.7±27.6y). Immunodeficiency disorders (congenital (OR= 39.1[95%CI:5.1-299]) or acquired (OR=10.3 [95%CI: 4.5-24.0]) was associated with increased risk of IMD. Autoimmune disorders, hemophilia and severe chronic respiratory disorders, prevalent in low socioeconomic status, increased hospitalization with highest risk observed in infants <1y (OR=4.81[95%CI:3.56-6.49]. During initial hospitalization, 35.1% required mechanical ventilation post-hospitalization, 41% was re-hospitalized at least once and 25.4% developed sequelae. 91.7% IMD patients survived initial hospitalization. During the follow up, mortality was highest between 25-59y, with a 16-years life expectancy reduction after initial hospitalization for patients aged from 0-50y old.

Conclusions/Learning Points: The substantial short- and long-term burden of IMD survivors was confirmed. A better understanding of risk factors, sequelae and long-term mortality highlights the importance of optimizing the prevention of IMD.

PD176 / #1370

SEXUAL HEALTH INDICATORS AND BEHAVIOURS OF A HUMAN PAPILLOMAVIRUS (HPV) VACCINATED COHORT OF FEMALE ADOLESCENTS IN CANADA

E-Posters

POSTER DISCUSSION SESSION 13: PUBLIC HEALTH & HIV

Megan Karpenko¹, Jennifer Gillis¹, Robine Donken², Darrel Cook³, Kim Marty¹, Simon Dobson¹, Mel Kraijden⁴, Laurie Smith⁵, Marie Helene Mayrand⁶, Chantal Sauvageau⁷, Vladimir Gilca⁷, Shelly Mcneil⁸, Jim Kellner⁹, Gina Ogilvie^{1,10}, Manish Sadarangani^{1,11}

¹University of British Columbia, Faculty Of Medicine, Vancouver, Canada, ²Amsterdam University Medical Centers, Department Of Epidemiology And Data Science, Amsterdam, Netherlands, ³BC Center for Disease Control, Bc Cdc Public Health Laboratory, Vancouver, Canada, ⁴BC Centre for Disease Control, Public Health Laboratory, Vancouver, Canada, ⁵BC Cancer Agency, Hpv Disease Control, Vancouver, Canada, ⁶Centre Hospitalier Université de Montréal, Départements D'obstétrique-gynécologie, Montreal, Canada, ⁷Université Laval, Faculty Of Medicine, Quebec City, Canada, ⁸Dalhousie University, Faculty Of Medicine, Halifax, Canada, ⁹University of Calgary, Faculty Of Medicine, Calgary, Canada, ¹⁰BC Center for Disease Control, Public Health, Vancouver, Canada, ¹¹BC Children's Hospital, Vaccine Evaluation Center, Vancouver, Canada

Backgrounds: As a majority of adolescents become human papillomavirus (HPV) immunized through school-based programs in Canada, it is important to understand the sexual health needs of these HPV vaccinated cohorts to support their sexual health and clinical care. Our objective was to describe sexual health indicators in a vaccinated cohort of adolescent females in Canada.

Methods: The Quadrivalent HPV Vaccine Evaluation Study (QUEST) follows female adolescent participants across Canada who either received 2 or 3 doses of HPV vaccine. Participants complete annual surveys, including demographic information and sexual health indicators. Data collection started in 2012 and is on-going. This descriptive analysis quantified sexual health indicators, examining age of sexual debut, condom usage, and sexually transmitted infections (STI).

Results: In total, 4115 QUEST participants have completed at least 1 questionnaire; median age at first questionnaire: 16y (range: 13-22). At first questionnaire, 54 (1.3%) declined to respond to questions regarding sexual health and 914 of the 4115 participants (22%) indicated they were already sexually active; median age at sexual debut was 15y (range: 12-17), 68% had one or two lifetime sexual partners, 37% had not used a condom at last sexual encounter, and 1.8% had been diagnosed with a STI. In subsequent questionnaires, an additional 1475 participants indicated they were sexually active and 166 reported ever having been diagnosed with an STI. In total, 2389 of the 4115 participants reported they were sexually active (58%), and 7.7% had been diagnosed with an STI.

Conclusions/Learning Points: These findings indicate a proportion of female adolescents engage in sexual activity without using STI prevention measures, highlighting the need for continued sexual health education among HPV vaccinated adolescents. This information will inform knowledge translation efforts for this population.

**A SYSTEMATIC LITERATURE REVIEW ON THE OPERATIONALIZATION OF VACCINE HESITANCY:
TOWARDS A CLEAR DEFINITION**

E-Posters

POSTER DISCUSSION SESSION 13: PUBLIC HEALTH & HIV

Daphne Bussink-Voorend¹, Jeannine Hautvast¹, Lisa Vandeberg², Olga Visser¹, Marlies Hulscher³

¹Radboud University Medical Centre, Primary And Community Care, Nijmegen, Netherlands, ²Radboud University, Behavioural Science Institute, Nijmegen, Netherlands, ³Radboud University Medical Centre, Iq Healhtcare, Nijmegen, Netherlands

Backgrounds: Owing to a decrease in vaccination coverage rates and a subsequent increase in vaccine-preventable diseases, vaccine hesitancy (VH) is now considered by the World Health Organization to be a top-10 global health threat. The concept of VH has been described and applied in various ways in the literature, leading to inconsistencies. This systematic review provides an overview of VH operationalization to suggest a way forward.

Methods: The search yielded 182 eligible studies from PubMed, Embase, and PsychINFO in three (partially overlapping) categories: 35 on VH conceptualization, 31 on VH subpopulations, and 144 on VH measurements.

Results: The qualitative analysis revealed that VH is conceptualized as involving cognitions or affect (i.e., having concerns or doubts or being reluctant), as a behaviour (i.e., accepting, delaying, or refusing vaccines), and as decision making (i.e., being undecided or indecisive or not yet having made a decision). These constitute distinct but interacting entities. Subpopulations are distinguished primarily on the basis of these conceptualizations. A wide variety of methods have been used to measure VH, each based on these conceptualizations and other related concepts.

Conclusions/Learning Points: Our findings indicate the varied and confusing use of VH operationalizations, leading to an impracticable concept. Clarification and simplification is required to aid further research on this highly relevant topic. The conceptualization of VH as 'vaccination behaviour' is problematic because it is insufficiently distinct and already in use as an indicator of vaccine non-acceptance. Instead, we propose that VH should be defined as a state of indecisiveness regarding a vaccination decision.

THE RISK OF CYTOMEGALOVIRUS (CMV) INFECTION IN FEMALE HEALTHCARE WORKERS: A SYSTEMATIC REVIEW

E-Posters

POSTER DISCUSSION SESSION 13: PUBLIC HEALTH & HIV

Anjalika Mallick¹, Rachel Cotton², Hermione Lyall³, Elizabeth Whittaker³

¹Imperial College Healthcare Trust, Picu, London, United Kingdom, ²Imperial College Healthcare Trust, Paediatrics, London, United Kingdom, ³Imperial Healthcare NHS Trust, Paediatric Infectious Diseases, London, United Kingdom

Backgrounds: CMV is a common, mild virus for immunocompetent individuals, but may cause congenital defects in babies of infected mothers. The consensus, without clear evidence, is that women in healthcare are more likely to contract CMV. Globally, there are differing occupational health policies, including exclusion of at-risk pregnant women from patient contact (as described in Germany and Italy). The aim of this systematic review was to determine if there is an increased risk of CMV for women in healthcare.

Methods: We searched for recent publications (2000-2020) in Medline, Embase and Cochrane and identified 1478 papers. 48 were explored in further detail by two reviewers. 8 articles with data on CMV seroprevalence in female healthcare workers were summarised independently.

Results: 2 studies met the exact criteria of our systematic review protocol, which was to compare CMV seroprevalence in female healthcare workers versus unexposed females (Table 1). Both groups did not find a statistically significant difference between the exposed and unexposed. The remaining 6 studies had data to support the review, but did not strictly adhere to the inclusion criteria for several reasons (no control group, inclusion of male participants, and inclusion of other occupations [ie. childcare]).

| | N. Lepage et al. | P. Zajac et al. |
|---------------------------------------|------------------|-----------------|
| Country | France | Poland |
| Exposed Seroprevalence % | 49.7% (n=386) | 87.8% (n=90) |
| Unexposed Seroprevalence % | 48.8% (n=164) | 86.7% (n=30) |
| Statistically significant difference? | No | No |

Conclusions/Learning Points: This systematic review highlights that there are very few recent studies to support or refute the theory that female healthcare workers are at greater risk of contracting CMV. This requires further evaluation to help guide occupational health policies and future vaccination policies.

RISK SCORE FOR DEVELOPING VENTILATOR-ASSOCIATED PNEUMONIA IN CHILDREN: THE RISVAP STUDY

E-Posters

POSTER DISCUSSION SESSION 13: PUBLIC HEALTH & HIV

Mònica Girona-Alarcon¹, Sara Bobillo-Perez², Anna Sole-Ribalta¹, Daniel Cuadras³, Carmina Guitart², Mònica Balaguer², Francisco José Cambra², Iolanda Jordan²

¹Sant Joan de Déu Hospital, Paediatric Intensive Care And Emergency Transport System, Esplugues de Llobregat, Spain, ²Sant Joan de Déu Hospital, Paediatric Intensive Care Unit, Esplugues de Llobregat, Spain, ³Sant Joan de Deu Hospital, Statistics Department, Esplugues de Llobregat, Spain

Backgrounds: Ventilator-associated pneumonia (VAP) is the second most common healthcare-associated infection in children, with a mortality rate that can reach 20%. The aim of this study was to determine the risk factors for VAP in children and to create a risk score for developing VAP (RISVAP score).

Methods: It was a retrospective observational study, including patients <18 years old who required mechanical ventilation (MV), registered in the multicentre ENVIN-HELICS database from 2014 to 2019. The regression coefficients of each independent risk factors for VAP were used to create the RISVAP score. If the factor was present, a score from 1 to 7 was assigned according to the n value.

Results: In total, 3798 patients were included, 97(2.5%) developing VAP. The following were identified as independent risk factors for VAP: female (OR 1.642, p =0.024), MV>4 days (OR 26.79, p <0.001), length in PICU>7 days (OR 11.74, p <0.001), and previous colonisation (OR 4.18, p <0.001). The RISVAP was calculated for each patient as the sum of all the independent risk factors. Three risk groups were obtained: low (0-5 points), intermediate (6-12 points), and high risk for VAP (13-16 points). The AUC for the final score was 0.905 (95%CI 0.888-0.923, p <0.001).

Conclusions/Learning Points: We have created the first risk score for VAP in paediatric population: the RISVAP score. We believe that using this predictive score, which includes the main risk factors related to VAP in children, might be helpful to detect vulnerable patients and therefore implement preventative strategies.

SEROTYPE DISTRIBUTION OF STREPTOCOCCUS PNEUMONIAE CAUSING INVASIVE AND NON-INVASIVE DISEASE IN CHILDREN ≤ 14 YEARS OF AGE IN GREECE IN THE LAST 5 YEARS (2015-2020)

E-Posters

POSTER DISCUSSION SESSION 13: PUBLIC HEALTH & HIV

Emmanouil Koutouzis¹, George Daikos², Charilaos Dellis¹, Athanasios Michos¹, Anthi Sideri³, George Kalogeras⁴, Theano Georgakopoulou⁵, Elizabeth- Barbara Tatsi¹, Foteini Koutouzi¹, Theodota Liakopoulou⁶, Levantia Zachariadou⁷, Vassiliki Syriopoulou¹

¹"Aghia Sophia" Children's Hospital, Division Of Infectious Diseases, First Department Of Pediatrics, Medical School, National And Kapodistrian University Of Athens, Athens, Greece, Athens, Greece, ². National and Kapodistrian University, Department Of Medicine, Athens, Greece, ³Mitera Children's Hospital, 3. department Of Microbiology, Athens, Greece, ⁴"P. & A. Kyriakou" Children's Hospital, Department Of Microbiology, Athens, Greece, ⁵National Public Health Organization, Department For Vaccine Preventable Diseases & Congenital Diseases, Directorate Of Epidemiological Surveillance And Interventions For Infectious Diseases, Athens, Greece, ⁶Iaso Children's Hospital, 6. department Of Pediatrics, Athens, Greece, ⁷"Aghia Sophia" Children's Hospital, Microbiology, Athens, Greece

Backgrounds: Immunization with pneumococcal conjugate vaccines (PCVs) has reduced significantly the invasive pneumococcal diseases (IPD) and non-IPD caused by vaccine serotypes whereas the number of PD associated with non-vaccine serotypes is increasing. This study aims to identify the leading pneumococcal serotypes associated with PD in children post-PCV introduction and ahead of licensure of 15- and 20-valent PCVs.

Methods: The study was conducted between November 2015 and December 2020 in 5 pediatric hospitals located in Greece. Data were collected prospectively from children ≤ 14 years of age diagnosed with PD. All pneumococcal isolates were serotyped by latex agglutination and Quellung reaction using anti-sera (Statens Serum Institut, Copenhagen, Denmark). The study was approved by the local hospital ethics committees.

Results: During the 5-year period, 333 children were diagnosed with PD; 98 with IPD and 235 with non-IPD. Acute otitis media was the most frequent infection (69.8%) followed by bacteremia (16.3%), pneumonia/empyema (9.1%), meningitis (3%), and other (1.8%). Serotypes 19A and 3 were the predominant causes of PD (15% each), followed by serotypes 11A, 15A, 19F, 23B, 15C, 10A, 23A, 12F, 35F. Overall, PCV13 serotypes were responsible for 42.9% of PD (38.8% for IPD, 44.7% for non-IPD). PCV15 was estimated to potentially cover 46.3% of PD (42.9% of IPD, 47.7% of non-IPD) whereas PCV20 is expected to potentially cover 64.9% of PD (66.3% of IPD, 64.3% of non-IPD).

Conclusions/Learning Points: Childhood PD is associated with a wide number of serotypes in our region. The persistence of serotypes 19A and 3 highlights the need for timely pneumococcal vaccination of all children. PCV15 and PCV20 are estimated to help further increase coverage of disease. Surveillance studies are necessary to monitor the epidemiology and inform vaccination policies.

CANDIDA DUBLINIENSIS AND CANDIDA ALBICANS ASSOCIATED WITH EARLY CHILDHOOD CARIES IN PRESCHOOL CHILDREN – A CASE-CONTROL STUDY

E-Posters

POSTER DISCUSSION SESSION 13: PUBLIC HEALTH & HIV

Michaela Cvanova^{1,2}, Filip Ruzicka³, Martina Kukletova⁴, Bretislav Lipovy⁵, Daniela Gachova¹, Lydie Izakovicova Holla⁴, Zdenek Danek^{1,6}, Veronika Hola³, Michaela Bartosova⁴, Jiri Jarkovsky², Ladislav Dusek², Petra Borilova Linhartova^{1,4,6,7}

¹Faculty of Science, Masaryk University, Recetox, Brno, Czech Republic, ²Faculty of Medicine, Masaryk University, Institute Of Biostatistics And Analyses, Brno, Czech Republic, ³Faculty of Medicine, Masaryk University, Clinic Of Microbiology, Institution Shared With St. Anne´s University Hospital, Brno, Czech Republic, ⁴Faculty of Medicine, Masaryk University, Clinic Of Stomatology, Institution Shared With St. Anne´s University Hospital, Brno, Czech Republic, ⁵Faculty of Medicine, Masaryk University, Clinic Of Burns And Plastic Surgery, Institution Shared With University Hospital Brno, Brno, Czech Republic, ⁶Faculty of Medicine, Masaryk University, Clinic Of Maxillofacial Surgery, Institution Shared With The University Hospital Brno, Brno, Czech Republic, ⁷Faculty of Medicine, Masaryk University, Department Of Pathophysiology, Brno, Czech Republic

Backgrounds: Dental caries is the worldwide most common infectious disease within the oral cavity. Caries in the primary dentition is referred to as Early Childhood Caries (ECC) and is associated with the presence of oral cariogenic bacteria. The role of other oral candidas in the ECC development is not fully understood. Our study aimed to investigate the occurrence of Candida sp. in preschool children according to their oral status.

Methods:: In this case-control association study, samples of dental plaque were collected from 164 children with ECC (with 6 or more of decayed, missed or filled teeth) and 147 children without dental caries. MALDI-TOF mass spectroscopy was used to identify Candida sp.

Results: In all, 12 Candida sp. were identified in our study group. The occurrence of Candida sp. was significantly associated with sECC (odds ratio, OR 11.40, $p < 0.001$). The strongest association was with *C. dubliniensis* (OR 13.50, $p < 0.001$) and *C. albicans* (OR 6.83, $p < 0.001$).

Conclusions/Learning Points: The presence of *C. dubliniensis* and *C. albicans* in dental plaque is an important indicator of dental caries development in preschool children. This research was supported by Ministry of Health of the Czech Republic, grant number: IGA NR8394-3/2005, NV17-30439A, NU20-08-00205, and by a project provided by University Hospital Brno, Ministry of Health Czech Republic – RVO (FNBr, 65269705). This publication has received funding from the European Union's Horizon 2020 Research and Innovation Programme under grant agreement No 857560. Authors also thank the Research Infrastructure RECETOX RI (No LM2018121) and project CETOCOEN EXCELLENCE (No CZ.02.1.01/0.0/0.0/17_043/0009632) financed by the Ministry of Education, Youth and Sports for supportive background.

THE IMPACT OF DEFERRED AND INTERRUPTED ART ON TELOMERE LENGTH IN CHILDREN WITH PERINATALLY-ACQUIRED HIV FROM THE CHER TRIAL

E-Posters

POSTER DISCUSSION SESSION 13: PUBLIC HEALTH & HIV

Laura Arencibia¹, Ginevra Pistocchi¹, Carlota Miranda², Avy Violari³, Mark Cotton⁴, Diana Gibb⁵, Nigel Klein², Helen Payne¹

¹Imperial College London, Paediatric Infectious Diseases, London, United Kingdom, ²University College London, Paediatric Infectious Diseases, London, United Kingdom, ³Chris Baragwanath Hospital, Perinatal Hiv Research Unit, Johannesburg, South Africa, ⁴Stellenbosch University, Paediatric Infectious Diseases, Cape Town, South Africa, ⁵University College London, Mrc Clinical Trials Unit, London, United Kingdom

Backgrounds: Children with perinatally-acquired HIV (paHIV) have shorter telomere length (TL) than HIV-uninfected children, however the impact of different ART-strategies on TL has not been well-described. We investigated how TL was affected by deferred and interrupted ART in the children with HIV early antiretroviral (CHER) trial.

Methods:: Infants with paHIV <12 weeks old with CD4% \geq 25% were randomized in the CHER trial to early limited ART for 40 or 96 weeks (ART-40W, ART-96W), or deferred ART (ART-Def). For ART-Def infants or following ART-interruption in ART-40W/ART-96W, ART was started/re-started for clinical progression or CD4% <25%. Absolute TL was quantified by PCR from DNA extracted from 129 samples of peripheral blood mononuclear cells collected at 96 and 248 trial weeks, compared to 160 healthy HIV-uninfected South African children.

Results: paHIV infected samples had significantly shorter TL than HIV-uninfected children at 96 weeks ($p < 0.0001$) but not at 248 weeks ($p = 0.074$). Although there was no significant difference between all CHER arms at 96 or 248 weeks, earlier ART-initiation and greater duration of ART were associated with longer TL in ART-Def ($R = 0.40$, $p = 0.065$ and $R = 0.45$, $p = 0.008$ respectively). No significant difference was observed in TL-change within the individuals between 96 and 248 weeks comparing interrupted ART (ART-96W) with deferred but continuous ART (ART-Def). No association was found between TL and measures of proviral DNA or anti-gp120 antibody.

Conclusions/Learning Points: Early ART-initiation and greater duration of ART is associated with longer TL reinforcing strategies for early detection, ART-initiation and limitation of ART-interruption during early childhood years, thereby preserving childhood immune-maturation. Despite periods of ART-interruption, the reactive nature of the CHER trial ART-strategies in the early-ART arms appeared to preserve TL to within expected range for HIV-uninfected children.

BIOBANKING AND CONSENTING TO RESEARCH: A QUALITATIVE THEMATIC ANALYSIS OF YOUNG PEOPLE'S PERSPECTIVES

E-Posters

POSTER DISCUSSION SESSION 13: PUBLIC HEALTH & HIV

Fabian Van Der Velden^{1,2}, Lily Gills³, Jasmin Broadey⁴, Louise Hayes⁵, Eve Roberts⁶, Jack Courtney³, Joanne Ball³, Marieke Emonts^{1,2}, Emma Lim^{1,5}

¹Great North Children's Hospital, Paediatric Immunology, Infectious Diseases And Allergy, Newcastle upon Tyne, United Kingdom, ²Newcastle University, Translational And Clinical Research Institute, Newcastle upon Tyne, United Kingdom, ³Great North Children's Hospital, Young Person's Advisory Group North England, Newcastle Upon Tyne, United Kingdom, ⁴Great North Children's Hospital, The Great North Youth Forum, Newcastle upon Tyne, United Kingdom, ⁵Newcastle University, Population Health Sciences Institute, Newcastle upon Tyne, United Kingdom, ⁶Great North Children's Hospital, General Paediatrics, Newcastle upon Tyne, United Kingdom

Backgrounds: Biobanking samples and consent are common practice in paediatric infectious diseases research. We aimed to gain insight into children and young people's (CYP) knowledge and perspectives around current biobanking and consent practices, to improve consent procedures.

Methods:: We designed a survey aimed at CYP, collecting demographic data, views on biobanking, and consent using three scenarios: 1) prospective consent, 2) deferred consent, and 3) re-consent and assent. The survey was disseminated via Young Person's Advisory Group North England and participating CYP's secondary schools. Data were analysed utilising a qualitative thematic approach by three independent reviewers, and common themes identified. Data triangulation occurred independently by a 4th reviewer.

Results: 102 CYP completed the survey. Most were between 16-18 years (63.7%, n=65) and female (66.7%, n=68). 72.3% had no prior knowledge of biobanking (n=73) Prospective consent acceptability for biobanking was high (91.2%, n=93); main themes 'altruism' and 'potential benefits outweigh individual risks', and 'increased complication risk'. Deferred consent acceptability was lower (84.3%, n= 86), common themes: 'altruism', 'body integrity', and 'sample frugality'. 76.5% preferred to re-consent when mature enough to give assent (n=78). 79.2% wanted to be informed if their biobanked sample is reused (n=80).

Conclusions/Learning Points: Prospective and deferred consent acceptability for biobanking is high among CYP. 'Altruism', 'frugality' and 'body integrity' are important themes. Clear communication and justification are paramount. CYP with capacity should be part of the consenting procedure, whenever possible. Acknowledgements This project received funding under the European Union's Horizon2020 Research and Innovation programme, under grant agreement number 848196.

PD185 / #417

NOVEL HICKMAN UNCUFFED LINES SHOW DECREASED RATE OF INFECTIONS IN PAEDIATRIC PATIENTS

E-Posters

POSTER DISCUSSION SESSION 14: MISCELLANEOUS

Chelsea Stubbs, Ashwin Venkatakrishnan, Bryan Chng
Imperial College London, School Of Medicine, London, United Kingdom

Backgrounds: Central Venous Catheter (CVC) placement is a necessary method of managing certain conditions as they allow for parenteral nutrition, direct administration of medication and sampling of blood. Associated with CVCs, however, is a high rate of Central Line Associated Blood Stream Infections (CLABSIs) in the paediatric population, which is an under-reported demographic in the literature. Several devices have been reported on for their use in this population, however the new Hickman-Uncuffed Lines have yet to be evaluated for their CLABSI rates in any patient population.

Methods: A retrospective observational study of the incidence of CLABSIs per catheter-day in 344 paediatric patients served by St Mary's Hospital, London was conducted. Incomplete and ambiguous data was removed, leaving 271 suitable records. Patients included had received a CVC between January 2014 and June 2021. CVC data included line type (Portacath, Hickman-Cuffed (HC), Hickman-Uncuffed (HuC), and Peripherally-Inserted Central Venous Catheter (PICC)), as well as line location and line size. Data was also collected on patient demographics, number of catheter-days, and whether a CLABSI was reported.

Results: A total of 271 patients, with an amalgamated 45,887 catheter-days, were analyzed. The CLABSI rate per 1000-catheter-days was calculated for each device, typical range reported in literature being 1.0-2.7: Portacath 0.27 (n=31), HC 2.11 (n=119), HuC 0.00 (n=38), PICC 1.29 (n=83). Patient mean age at line insertion was 92.08 months \pm 66.7 SDs. Mann-Whitney U Test showed a significant association between line type and CLABSI rate (p=0.0390).

Conclusions/Learning Points: The new Hickman Uncuffed Lines show promising results for reduced CLABSI rates in the paediatric population, especially when compared to the more-widely used Hickman Cuffed Lines. More research is required to evaluate their efficacy compared to this and other more-established CVCs.

RECOMBINANT HUMAN PLASMA GELSOLIN SIGNIFICANTLY INCREASES PHAGOCYTOSIS OF CANDIDA AURIS CELLS BY HUMAN NEUTROPHILS

E-Posters

POSTER DISCUSSION SESSION 14: MISCELLANEOUS

Łukasz Suprewicz¹, Ewelina Pikel¹, Piotr Deptuła¹, Sylwia Chmielewska¹, Karol Skłodowski¹, Alicja Walewska², Sylwia Księżak², Tomasz Wollny³, Grzegorz Król⁴, Robert Bucki¹

¹Medical University of Białystok, Department Of Medical Microbiology And Nanobiomedical Engineering, Białystok, Poland, ²Medical University of Białystok, Department Of Regenerative Medicine And Immune Regulation, Białystok, Poland, ³Holy Cross Oncology Center of Kielce, Holy Cross Oncology Center Of Kielce, Kielce, Poland, ⁴Jan Kochanowski University in Kielce, Department Of Microbiology And Immunology, Kielce, Poland

Backgrounds: Impairment of innate immune response in immunocompromised subjects, predispose to recurrent and life-threatening fungal infections. Decrease of plasma gelsolin (pGSN) concentration (hypogelsolinemia) that was observed in the blood of patients with septic shock, tissue injuries, different chronic diseases and cancers, highlight its crucial role in severe medical conditions. Recent studies demonstrated the ability of pGSN to stimulate phagocytosis in bacterial-infected mice. Nevertheless, the data about involvement of human plasma gelsolin in host response to fungal infections are still very limited.

Methods: To isolate neutrophils blood obtained from healthy volunteers was centrifuged in Polymorphprep density gradient. To assess the effect of pGSN on neutrophils function, cells were serum starved for 1h, preincubated with pGSN, washed and infected with *C. auris*. As control fungal cells were also added to serum starved neutrophils simultaneously with corresponding concentration of pGSN. Internalization of pHrodo zymosan particles and extracellular DNA release was evaluated using a IncuCyte SX1 Live Imaging System. Process of NETosis was monitored using MPO activity and observed using a confocal microscope. Fluorometric assay was used to determine ROS formation. Alternation of inflammatory response upon pGSN treatment of *C. auris* infected neutrophils was monitored with use of magnetic bead-based assay.

Results: Preincubation of human neutrophils with pGSN significantly improved uptake of *Candida auris* cells with simultaneous reduction of NETotic death as well as inflammatory response.

Conclusions/Learning Points: The number of agents with potent antifungal activity is significantly limited, and those that are approved for clinical use are often very toxic or insufficiently effective, which justify and motivate research and development of new methods using molecules with novel and/or alternative mechanisms of action. Recombinant human pGSN due to its immunomodulatory properties is a candidate worth consideration.

The work was supported by the National Science Centre, Poland, under research project Preludium bis 1, no UMO-2019/35/O/NZ6/02807.

IMMUNOCOMPROMISED CHILDREN AND YOUNG PEOPLE DID NOT HAVE INCREASED RISK OF SEVERE COVID-19 IN A PROSPECTIVE COHORT STUDY DESPITE INFECTION

E-Posters

POSTER DISCUSSION SESSION 14: MISCELLANEOUS

Harry Chappell¹, Ravin Patel², Mala Mistry², Corine Driessens³, Lynne Mills¹, Meera Shaunak¹, Diane Gbesemete^{1,2}, Alice Leahy⁴, Jane Lucas^{1,2,4}, Saul Faust^{2,4,5}, Hans De Graaf^{1,2,4}

¹University Hospital Southampton NHS Trust, Nihir Southampton Clinical Research Facility And Biomedical Research Centre, Southampton, United Kingdom, ²University of Southampton, Faculty Of Medicine And Institute For Life Sciences, Southampton, United Kingdom, ³University of Southampton, Nihir Applied Research Collaboration Wessex, Southampton, United Kingdom, ⁴University Hospital Southampton NHS Trust, Paediatric Medicine, Southampton, United Kingdom, ⁵University of Southampton, Nihir Southampton Clinical Research Facility, Southampton, United Kingdom

Backgrounds: Emerging data suggests little increase in morbidity or mortality in immunocompromised children and young people (CYP) from SARS-CoV-2 infection compared to non-immunocompromised children between the first and second pandemic waves in the UK (Swann at al and gov.uk). This is still an area of concern, particularly with uncertainties around emerging variants. We aimed to describe the incidence and clinical spectrum of SARS-CoV-2 infection in a large cohort of immunocompromised paediatric patients in the UK while wild type, alpha and delta strains were predominant.

Methods: In this prospective cohort study, from March 2020 – November 2021 weekly questionnaires were sent to immunocompromised paediatric patients or their parents. Information, including symptom presentation and SARS-CoV-2 PCR results, was collected from 1527 participants from 46 UK hospitals.

Results:

Number of participant SARS-CoV-2 infections by week (28th September 2020 to 8th November 2021)

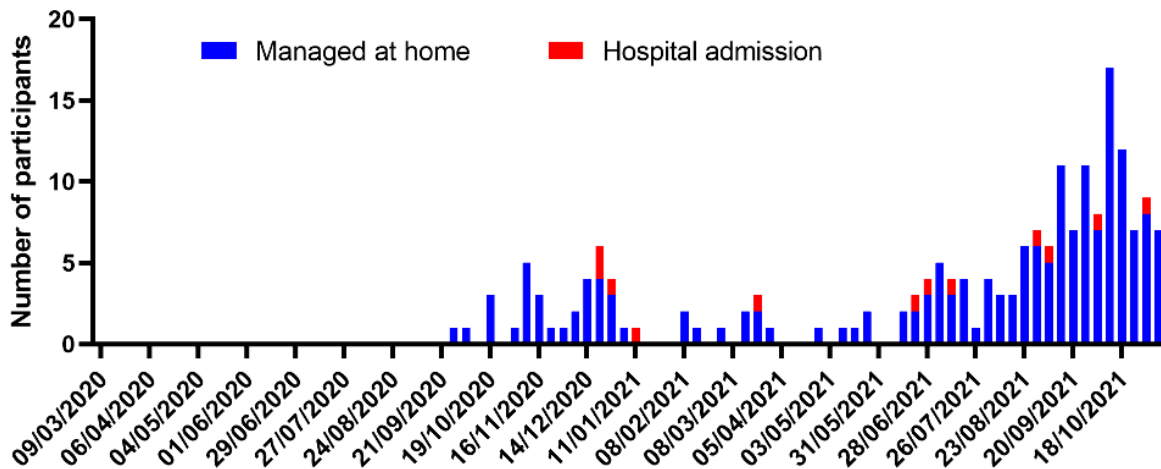

A total of 190 participants reported positive SARS-CoV-2 PCR results, of these 12 were subsequently or concurrently admitted to hospital. Clinical presentation was varied but none reported acute severe COVID-19 or paediatric multisystem inflammatory syndrome. None were admitted to paediatric intensive care units or died. During the government advised shielding period (March – August 2020) no SARS-CoV-2 infections were reported. The first positive SARS-CoV-2 PCR was in the week commencing 28th September 2020. Peaks in positive tests occurred in the weeks commencing 9th November and 21st December 2020. Since 14th June 2021, there has been an ongoing wave of positive cases.

Conclusions/Learning Points: Infection rates appear to correspond to UK national rates. They suggest early government shielding measures were effective. Subsequently cases were detected with no evidence of increased morbidity or mortality in this cohort of immunocompromised CYP, when alpha and delta strain were predominant. The study is ongoing and will continue to observe for impacts of the omicron variant.

PD188 / #416

INFECTIOUS INDICATIONS NOT ASSOCIATED WITH CENTRAL LINE INFECTIONS IN PAEDIATRIC PATIENTS

E-Posters

POSTER DISCUSSION SESSION 14: MISCELLANEOUS

Ashwin Venkatakrishnan¹, Bryan Chng¹, Chelsea Stubbs²

¹Imperial College London, Imperial College School Of Medicine, London, United Kingdom, ²Imperial College London, School Of Medicine, London, United Kingdom

Backgrounds: Central venous catheters (CVCs) are used for long-term venous access to deliver different types of materials, such as parenteral nutrition, antimicrobials, chemotherapeutic agents and blood products. There is however a risk of Central Line-Associated Bloodstream Infections (CLABSIs). Since CLABSIs are a significant cause of morbidity within the paediatric population, healthcare professionals are cautious in using them in patients with pre-existing infections, worrying of worsening the situation. Here, we investigated the relationship between infection status and CLABSI incidence rate in paediatric patients.

Methods: Data from all paediatric patients aged 0-18, who had central lines placed in St Mary's Hospital, London, from Jan 2018 to June 2021 were collected retrospectively. Patient demographics, number of catheter days, indication for catheter and premature removals were all catalogued. Entries with incomplete data were removed. Patients were then split into two groups based on whether their indication for catheter was of an infectious nature and a Mann-Whitney U test was performed.

Results: 287 patients were included in the final analysis. There were 0.84 CLABSIs/1000 catheter days in patients with infectious indications, and 1.21 CLABSIs/1000 catheter days in patients without infectious indications. Mann-Whitney U test showed no significant relationship ($p = 0.667$) between pre-existing infection status and CLABSI rates in paediatric patients.

Conclusions/Learning Points: The results suggest that central lines can be inserted in paediatric patients with infections as they are not at a higher risk of CLABSIs. Multivariate analysis needs to be done to control for all other variables to ascertain the true nature of the relationship between Infectious status and CLABSI rates.

IN CHILDREN YOUNGER THAN 3 YEARS OLD, RT-PCR IN ORAL SWABS IS BETTER THAN ANTIGEN RAPID TEST FOR DETECTION OF SARS-COV-2 INFECTION?

E-Posters

POSTER DISCUSSION SESSION 14: MISCELLANEOUS

Cinta Moraleda^{1,2}, Sara Domínguez¹, Juan Miguel Mesa³, Paula García⁴, María De La Serna³, Jose Alonso-Cadenas⁵, Amanda Bermejo⁶, Gema Sabrido⁷, Leticia Martínez-Campos⁸, Aranzazu Flavia González-Posada⁹, Marta Illán-Ramos¹⁰, Jorge Lorente¹¹, Ana Belen Jimenez¹², Álvaro Ballesteros¹, David Aguilera-Alonso^{1,13}, Daniel Blázquez-Gamero², Alfredo Tagarro^{1,14}, Working Group Epico-Aep¹

¹Foundation for Biomedical Research Hospital 12 de Octubre, Instituto De Investigación 12 De Octubre (imas12), Madrid, Spain, ²Hospital Universitario 12 de Octubre, Pediatric Infectious Diseases Unit. Department Of Pediatrics, Madrid, Spain, ³Hospital Universitario Infanta Sofía, Pediatrics, San Sebastian de los Reyes, Spain, ⁴Hospital Universitario La Paz, Emergency Pediatric Department, Madrid, Spain, ⁵Hospital Infantil Universitario Niño Jesús, Emergency Pediatric, Madrid, Spain, ⁶Hospital Universitario de Móstoles, Pediatric Department, Madrid, Spain, ⁷Hospital Universitario Rey Juan Carlos, Pediatric Department, Madrid, Spain, ⁸Hospital Universitario Torrecárdenas, Department Of Pediatrics, Almería, Spain, ⁹Hospital Universitario 12 de Octubre, Emergency Pediatric Department, Madrid, Spain, ¹⁰Clínico San Carlos Hospital, Paediatrics, Madrid, Spain, ¹¹Hospital Gregorio Marañón, Emergency Pediatric Department, Madrid, Spain, ¹²Hospital Universitario Fundación Jimenez Diaz, Department Of Pediatrics, Madrid, Spain, ¹³Hospital Universitario Gregorio Marañón, Pediatric Infectious Diseases Unit. Department Of Pediatrics, Madrid, Spain, ¹⁴Hospital Universitario Infanta Sofía, Paediatrics, San Sebastián de los Reyes, Spain

Backgrounds: RT-PCR using nasopharyngeal swabs (NPS) is the gold standard for the SARS-CoV-2 infection diagnosis. Antigen rapid diagnostic tests (Ag-RDT) have replaced RT-PCR on NPS in several situations due to their low cost and convenience. RT-PCR in oral swabs is a more comfortable alternative than NPS. There is scarce information on the accuracy of both techniques in children younger than 3 years old.

Methods: We present a secondary analysis of a cross-sectional multicenter study that evaluated the adequacy of Ag-RDT on NPS and oral swab RT-PCR compared to the gold standard in children. We offered participation to children 0-18 years old with COVID-19 symptoms of ≤5 days of duration, whose parents consented between February and March 2021. Two NPS (Ag-RDT and RT-PCR) and one oral swab for RT-PCR were collected at emergency departments, in ten Spanish hospitals. A subanalysis of the children younger than 3 years old was performed.

Results: 1174 children were included in the main analysis. The median age was 3.8 years (interquartile range (IQR), 1.7-9.0), 516/1174 (44.0%) were ≤3 years old. A total of 18/516 (3.5%) children ≤3 years old tested positive by at least one of the techniques. The performance of the two analyzed tests versus the gold standard is shown in table 1. Oral swab RT-PCR showed similar performance in children stratified by age. By contrast, Ag-RDT showed lower sensitivity in children ≤3 years (Table 1). Among the four cases with negative Ag-RDT and positive oral swab, 3 were ≤3 years old.

Table 1. Performance of the studied tests compared with the gold standard test stratified by age.

| (%, 95%CI) | All N=1174 | ≤3 years old N=516 | >3 years old N=658 |
|--------------------------------------|---------------------|-----------------------|-----------------------|
| RT-PCR on oral swab | | | |
| Sensitivity | 72.1% (59.8-82.27) | 75% (47.6-92.73) | 71.1% (56.9-82.87) |
| Specificity | 99.6% (99.1-99.9) | 99.6% (98.6-99.9) | 99.7% (98.8-99.9) |
| Positive Predictive Value | 92.4% (82.0-97.1) | 85.7% (59.4-96.1) | 94.9% (82.1-98.7) |
| Negative Predictive Value | 98.3% (97.5-98.8) | 99.2% (98.1-99.7) | 97.6% (96.3-98.4) |
| Kappa index | 0.79 (0.72-0.88) | 0.79 (0.63-0.95) | 0.8 (0.71-0.89) |
| Positive Likelihood Ratio | 199.24 (74.1-535.9) | 187.5 (45.7-769.4) | 215.6 (53.4-869.4) |
| Negative Likelihood Ratio | 0.28 (0.19-0.41) | 0.25 (0.11-0.59) | 0.29 (0.19-0.44) |
| Ag-RDT on nasopharyngeal swab | | | |
| Sensitivity | 61.8% (49.2-73.3) | 43.7% (19.8-70.1) | 67.3% (52.9-79.7) |
| Specificity | 99.9% (99.5-100) | 100% (99.2-100) | 99.8% (99.1-100) |
| Positive Predictive Value | 97.7% (85.4-99.7) | 100% | 97.2% (83.0-99.6) |
| Negative Predictive Value | 97.7% (96.9-98.3) | 98.2% (97.3-98.4) | 97.3% (96.0-98.1) |
| Kappa index | 0.74 (0.65-0.84) | 0.6 (0.36-0.83) | 0.78 (0.68-0.87) |
| Positive Likelihood Ratio | 97.7% (85.4-99.7) | - | 407.9 (57.0-2917.6) |
| Negative Likelihood Ratio | 0.38 (0.3-0.5) | 0.56 (0.37-0.87) | 0.33 (0.22-0.48) |

CI: confidence interval; Ag-RDT: antigen rapid test.

Conclusions/Learning Points: RT-PCR on oral swabs is an accurate option for SARS-CoV-2 testing in children ≤3 years old, but Ag-RDT has poor sensitivity. Younger children might benefit from oral swab RT-PCR in testing guidelines, possibly even before Ag-RDT.

SERUM LEVELS OF MATRIX METALLOPROTEINASES IN CHILDREN WITH MULTISYSTEM INFLAMMATORY SYNDROME (MIS-C)

E-Posters

POSTER DISCUSSION SESSION 14: MISCELLANEOUS

Kacper Toczyłowski¹, Dawid Lewandowski¹, Diana Martonik², Marta Sawicka¹, Ewa Bojkiewicz¹, Marta Wozinska-Klepadlo¹, Artur Sulik¹

¹Medical University of Białystok, Department Of Pediatric Infectious Diseases, Białystok, Poland, ²Medical University of Białystok, Department Of Infectious Diseases And Hepatology, Białystok, Poland

Backgrounds: Matrix metalloproteinases (MMPs) and their inhibitors, known as tissue inhibitors of MMP (TIMPs), play central roles in the process of the extracellular matrix synthesis and breakdown. Accelerated matrix breakdown caused by increased activity of MMPs or an imbalance between MMP and TIMP can result in pathological conditions, including vascular damage during the acute phase of Kawasaki disease. Little is known about the role of MMPs and TIMP in the pathophysiology of multisystem inflammatory syndrome in children linked to COVID-19 (MIS-C).

Methods: 18 children hospitalized with MIS-C between May 2020 and December 2020 were included in the study. Serum samples were collected on admission (T1) and then on day 7, after the anti-inflammatory treatment (T2). Concentrations of 9 different matrix metalloproteinases, their inducers (TNF α and EMMPRIN), and 4 tissue inhibitors were assessed using the microbead-based Luminex assay. The control group comprised of 9 children without infection and inflammation.

Results: On T1, children with MIS-C had elevated concentrations of TIMP1, TIMP3, TIMP4, EMMPRIN, TNF α , MMP3, MMP7, and MMP8, compared to controls. Concentrations of TIMP4, EMMPRIN, TNF α , MMP7, and MMP8 normalized on T2. Despite treatment, concentrations of TIMP1 and MMP3 remained elevated on T2, whereas concentrations of TIMP3 and MMP1 increased on T2, compared to T1. Pericardial effusion was associated with a 2.5-fold higher concentration of MMP-3 on T1. Children with reduced LV contractility showed a 1.7-fold higher MMP-9 levels on T2.

Conclusions/Learning Points: Circulating levels of proteolytic enzymes which act on the extracellular matrix are elevated in MIS-C patients. The MMP3 level at the early stage of illness and the MMP9 level after anti-inflammatory therapy were associated with cardiac involvement. These data indicate that circulating levels of MMP may be related to the severity of MIS-C.

PD191 / #547

IMPACT OF OBESITY ON THE OUTCOME OF VIRAL INFECTIONS IN CHILDREN AND ADOLESCENTS.

E-Posters

POSTER DISCUSSION SESSION 14: MISCELLANEOUS

Dimitra - Irinna Vitoratou, Olga Fafoula, Paraskevi Korovessi, Stavroula Kostaridou, Patra Koletsi
Penteli Children's Hospital, Paediatric, Penteli, Greece

Backgrounds: New evidence shows an impaired immune response in obese children and adolescents when fighting against viral infections. Translational studies have shown that obesity is characterised by chronic low-grade inflammation maintained by the secretion of pro-inflammatory cytokines and reactive oxygen species from excess adipose tissue, induced by the disturbed circulation of adipokines. We aimed to systematically review the impact of obesity on the outcome of viral infections in children and adolescents using real-world data.

Methods: We searched PubMed for articles published up to 30/08/2021 using the following criteria: (obesity OR BMI OR metabolic syndrome) AND (viral infection OR virus OR influenza OR COVID-19 OR SARS-CoV-2) AND (child OR adolescent).

Results: We found 19 eligible studies. Regarding COVID-19, most studies identified obesity as a significant risk factor for severe disease and subsequent hospitalization. Meanwhile, three observational studies on MIS-C found a high prevalence of obesity among paediatric patients. Data was not definitive concerning influenza and influenza-like illness, as four studies showed an unfavourable outcome on disease severity, risk of hospitalisation and death, whereas the other five demonstrated insignificant associations in the younger age groups. Furthermore, obesity was associated with more days of wheezing, fever, and drip infusion in RSV infection. Higher odds of developing severe dengue infection in obese children has been showed in a recent meta-analysis. Finally, two studies referring to chronic Hepatitis C show a significant association between obesity and progression to liver fibrosis and impaired sustained virologic response to treatment.

Conclusions/Learning Points: Public health policies should be urgently redirected to the prevention of excess weight gain in children in order to improve their metabolic health and immunity, thus acting as a powerful prevention measure for counteracting the consequences of viral infectious diseases.

PD192 / #1014

CHROMOSOMALLY INTEGRATED HHV-6 IN AN ASYMPTOMATIC NEONATE.

E-Posters

POSTER DISCUSSION SESSION 14: MISCELLANEOUS

Garyfallia Syridou¹, Artemis Mavridi¹, Eleni Kapsabeli², Anna Daskalaki², Nikolaos Siafakas³, Nikolaos Spanakis⁴, George Sourvinos⁵, Vassiliki Papaevangelou¹

¹National and Kapodistrian University of Athens, Third Department Of Pediatrics, Attikon University Hospital, Athens, Greece, ²National and Kapodistrian University of Athens, Neonatal Intensive Care Unit, Third Department Of Pediatrics, Attikon University Hospital, Athens, Greece, ³Attikon University Hospital, Microbiology Department, Athens, Greece, ⁴National and Kapodistrian University of Athens, Microbiology Department, School Of Medicine, Athens, Greece, ⁵University of Crete, Department Of Laboratory Medicine, School Of Medicine, Heraklion, Greece

Title of Case: Chromosomally integrated HHV-6 in an asymptomatic neonate

Background: Chromosomally integrated HHV-6 (ciHHV-6) is a rare condition where HHV6 genome is integrated into human chromosomes and transmitted to the offspring in a Mendelian manner. We report the first case in Greece of ciHHV6 in a neonate, an unexpected finding while being investigated for congenital toxoplasmosis.

Case Presentation Summary: A full term male neonate was referred to our Unit for investigation of a probable congenital toxoplasmosis, immediately after birth. The neonate, who had normal physical examination, had serology for toxoplasma gondii, cerebral US, ear and eye screening and CSF PCR for the parasite performed with normal findings, while film array in CSF turned unexpectedly positive for HHV6 DNA. PCR in plasma and whole blood were also both positive (2530 cp/ml and 2.200.000 cp/ml respectively) for HHV6 A. Ganciclovir IV was initially started and a second spinal tap was performed during treatment. HHV6 DNA was again found in CSF and whole blood in much higher viral load (7.965.000 cp/ml). Since there was no change in neonate's clinical condition, US findings and viral load despite treatment we investigated the whole family for HHV6 DNA in peripheral blood thinking of ciHHV-6. The mother and one brother were highly positive for HHV6 (2.731.500 cp/ml and 16.056.000 cp/ml respectively). We also performed HHV6 PCR in hair follicles of the neonate with negative results. In follow up viral load was still high, (over 500.000 cp/ml) and antiHHV6 IgG was positive.

Learning Points/Discussion: Since ciHHV6 is not commonly diagnosed especially in immunocompetent pediatric patients, we think that it is important to get familiar with this rare entity, in order to avoid misdiagnosis and unnecessary treatment, while long term follow up might be needed.

PD193 / #1768

GENETIC VARIATIONS IN LMP1 AND GP350/220 GENES OF EBV ISOLATED FROM PEDIATRIC PATIENTS WITH INFECTIOUS MONONUCLEOSIS FROM CROATIA

E-Posters

POSTER DISCUSSION SESSION 14: MISCELLANEOUS

Ivana Grgic, Marija Rozman, Snježana Židovec Lepej

University Hospital for Infectious Diseases "Dr. Fran Mihaljevic", Department For Immunological And Molecular Diagnostic, ZAGREB, Croatia

Backgrounds: Epstein-Barr virus (EBV) establishes a lifelong latent infection while the primary infection can lead to infectious mononucleosis (IM). Major envelope glycoprotein of the virus, gp350/220 binds to the B cell surface receptor CD21. Latent membrane protein 1 gene (LMP1) transforms B cells because of its similarity to the tumor necrosis factor receptor. C-terminus part of the of the protein shows significant variability with 7 defined LMP1 variants; B95-8, Alaskan, China 1, China 2, Med+, Med- and NC. The aim of this study is to detect polymorphisms of LMP1 and gp350/220 genes circulating in IM isolates of pediatric patients from Croatia.

Methods:: EBV DNA was extracted from whole blood samples of 24 IM pediatric patients (2-18 years). The genes LMP1 and gp350/220 were amplified using nested-PCR and sequenced using Sanger method. Sequences were aligned and compared with a reference wild-type sequence for each gene to detect polymorphisms.

Results: The analysis of 4 peptides of gp350/220 gene showed high similarity to the wild type, with E201Q and A384V mutations present in the N-terminus and Q642P and N672I in the C-terminus, with one sample carrying a 9 amino acid deletion (676-684). Wild type form of LMP1 gene was found in 6 samples, Med- in 2 samples and NC in one, coinfections of wild type with NC in 6, wild type with China 1 in 5 and one NC/China 1 while 3 samples carried wild type with China1/2/AL mutations. A 15-bp deletion, typical for samples from Western Europe was detected in 10

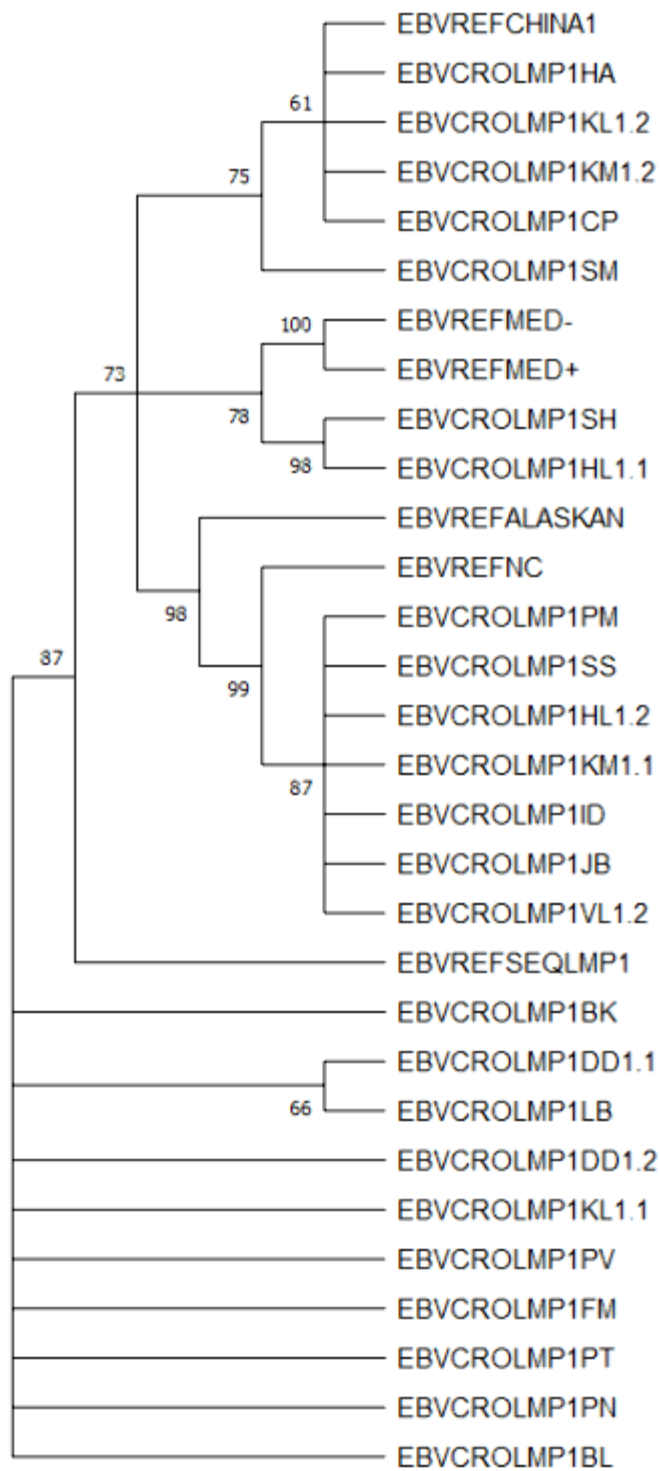

samples.

Conclusions/Learning Points: The results of this study show that gp350/220 gene sequences are very uniform, with almost no distinction from the wild type while LMP1 gene sequences show more variability.

EP001 / #1066

Topic: AS01. Antimicrobials / AS01.a. Novel antimicrobial treatments

EXTENSIVELY DRUG-RESISTANT PSEUDOMONAS AERUGINOSA MENINGOENCEPHALITIS IN AN INFANT TREATED WITH CEFIDEROCOL

E-Posters

E-POSTER VIEWING

Elisa Funicello^{1,2}, Federica Mignone², Giulia Pruccoli^{1,2}, Carlo Scolfaro², Erika Silvestro², Marco Denina², Elena Putoto^{1,2}, Silvia Garazzino²

¹University of Turin, Department Of Sciences Of Public Health And Pediatrics, Turin, Italy, ²Regina Margherita Children's Hospital, Pediatric Infectious Disease Unit, Turin, Italy

Title of Case: Extensively drug-resistant *Pseudomonas aeruginosa* meningoencephalitis in an infant treated with cefiderocol

Background: Meningoencephalitis caused by MDR strains is an uncommon infection in infants; the therapeutic approach is complex, with a recent increase in the use of new molecules such as cefiderocol.

Case Presentation Summary: A 1-month-old boy from Moldova was admitted to our department with a diagnosis of life-threatening meningitis by *Pseudomonas aeruginosa* made in the country of origin; no antibiograms were available. MRI at admission described tetraventricular hydrocephalus associated with diffuse ventriculitis. Intravenous (IV) vancomycin, amikacin, and meropenem were started as empirical treatment and two external ventricular drains were inserted. On day 9, CSF culture confirmed infection by a VIM Metallo-beta-lactamase-producing *Pseudomonas aeruginosa* (VIM-CRPA). Susceptibility tests showed resistance to piperacillin-tazobactam, cephalosporins, meropenem (MIC > 8 ug/mL), ceftazidime-avibactam, aminoglycosides, quinolones, and susceptibility to colistin. Firstly, IV colistin methanesulfonate was started. Secondly, considering in vitro synergistic activity of colistin and aztreonam, the latter was added to therapy. On day 18, because of radiological worsening, based on additional sensitivity tests, meropenem was replaced by cefiderocol (60 mg/kg/d q8h) with progressive improvement in MRIs images and subsequent negative CSF cultures results. The patient completed 8 weeks of treatment with cefiderocol uneventfully. At 45 days after the conclusion of antibiotic therapy, the patient has persistently negative CSF cultures.

Learning Points/Discussion: We report the first case of cefiderocol use in an infant for a VIM-CRPA cerebral infection. In this case, the negativization of CSF cultures and the radiological improvement coincided with the start of cefiderocol. Further studies are required to determine the pharmacokinetics and pharmacodynamics of cefiderocol in the pediatric population, as well as to define the most appropriate dose, duration of treatment, and combination therapy in case of MDR severe infections.

EP002 / #565

Topic: AS01. Antimicrobials / AS01.a. Novel antimicrobial treatments

CEFTAZIDIME-AVIBACTAM ROLE FOR THE TREATMENT OF CARBAPENEMASES INFECTIONS IN PEDIATRICS

E-Posters

E-POSTER VIEWING

Carmina Guitart¹, Elena Fresan-Ruiz¹, Mònica Girona-Alarcon², Mireia Mor³, Eneritz Velasco⁴, Miquel Villaronga⁵, Iolanda Jordan⁶

¹Hospital Sant Joan de Déu, Intensive Care Unit, Esplugues de Llobregat, Spain, ²Sant Joan de Déu Hospital, Paediatric Intensive Care And Emergency Transport System, Esplugues de Llobregat, Spain, ³Hospital Sant Joan de Déu, Intensive Care Unit, Esplugues, Spain, ⁴Hospital Sant Joan de Déu, Infectious Disease, Esplugues de Llobregat, Spain, ⁵Hospital Sant Joan de Déu, Pharmacy Service, Esplugues de Llobregat, Spain, ⁶Sant Joan de Déu Hospital, Paediatric Intensive Care Unit, Esplugues de Llobregat, Spain

Backgrounds: Carbapenem resistance rates in pediatric patients are increasing. New antibiotics such as ceftazidime-avibactam (CAZ-AVI) are potentially useful alternatives to antibiotic combinations including meropenem, but there is no consensus on its empirical use. CAZ-AVI has been approved for patients older than 3 months, with complicated intraabdominal infection, complicated urinary tract infection, hospital-acquired pneumonia, and other infections with limited therapeutic options. The aim was to describe the current use of CAZ-AVI in our hospital.

Methods: Consecutive case series including patients treated with CAZ-AVI due to suspected or confirmed infection caused by carbapenemase producing microorganisms (CPM) in a tertiary care children's hospital.

Results: Twenty patients with CPM were included: 9(45%) in colonization and 11(55%) with clinical infection(pneumonia, sepsis, urinary tract infections). Isolated microorganisms were 12 K.pneumoniae, 6 E.coli, and 2 P.aeruginosa (VIM, OXA, NDM y KPC). Of the 11 patients with infection, 8(72%) were males with a median age of 3.84 (IQR 1.73-6.13). Four patients required admission to the Pediatric Intensive Care Unit due to severe infections. Patients with clinical infection received meropenem as empirical treatment with unfavorable evolution. CAZ-AVI was used after CPM detection, in monotherapy, or in combination with aztreonam in infections due to metalloβ-lactamase PM. CAZ-AVI was used as first-line empirical therapy in patients with previously known colonization with suspected infection. CAZ-AVI was also indicated in one patient with cystic fibrosis. Considering new guidelines of CPM infections, and from our epidemiology, we could consider CAZ-AVI in patients with CPM: (1)invasive infections due to CPM(KPC, Oxa-48 y MBL); (2)patients who receive carbapenems because of BLEE infection and remain febrile >48 hours; (3)patients colonized with BLEE who develop septic shock.

Conclusions/Learning Points: Further studies and consensus should be elaborated to homogenize CAZ-AVI use in the pediatric population.

Topic: AS01. Antimicrobials / AS01.a. Novel antimicrobial treatments

ISAVUCONAZOLE OFF LABEL USE IN CHILDREN AND ADOLESCENTS: A SINGLE TERTIARY-PEDIATRIC-CARE-CENTER EXPERIENCE REVIEW

E-Posters

E-POSTER VIEWING

Mario Gutierrez-Gutierrez¹, Margarita Cuervas-Mons Vendrell², Blanca Molina Angulo¹, Iván López Torija¹, Marta González Vicent¹, Pilar Ranz Ortega¹, Marta García Ascaso¹

¹Hospital Universitario Niño Jesus, Paediatric Oncology, Madrid, Spain, ²Hospital Universitario Niño Jesus, Pharmacology, Madrid, Spain

Backgrounds: Isavuconazole (ISA) is a new generation broad-spectrum triazole with a promising role in invasive fungal diseases (IFD) since 2015. However, its paediatric-use is off-label, though it seems safe in paediatric immunocompromised patients, whose treatment is challenging because of classic agents limitations (interactions, drug-monitoring, adverse reactions...).

Methods: We retrospectively describe ISA prescription at our centre, related to patients and IFDs characteristics; ISA indication and posology; Isavuconazole plasma concentration (IPC); adverse events and outcomes. Data from patients who had received ISA from 30th/06/2020—01st/12/2021 were collected from electronic records. IPC was quantified at our reference centre (target range 2,5-5mg/L).

Results: Twelve patients were included, everyone with risk for IFD (table 1):

| | | |
|---------------------|---|---|
| Gender | Males—7(58,3%) | Females—5(41,7%) |
| Age(y.o.) | Median—11,5 | IQR:6—15,4 |
| Weight(kg) | Median—39,7 | IQR:20,7—52kg |
| Risk factors | HSCTR ¹ —11 (91,7%) - Corticoids—8 -Neutropenia—6 | Critical—1 (8,3%) |
| IFD EORTC diagnosis | Possible—3 25% | Probable—3 25% |
| | | Proven—4 33,3% - Candida kefyr - Rhizopus microsporus - Mucor species - Aspergillus flavus |
| | | No IFD—2 16,7% - Aspergillus spp airway colonisation - Previous esophageal candidiasis |

¹Hematopoietic-stem-cell transplantation recipient

Reason to switch to ISA (oral or intravenous) for treatment(83,3%) or prophylaxis(16,7%): IFD-progression(58,3%), toxicity(25%), ambulatory oral administration(8,3%) or mucor diagnosis(8,3%). Charge-treatment was always carried. Nevertheless, only 2 patients reached target range in first IPC-quantification (available in 10). Median IPC—2,055mg/L; IQR:1,53—2,76). Adverse events: hypertransaminasemia (91,7%), creatinine rise (50%), nausea (16,7%), neutropenia (8,3%). Outcomes: IFD resolution (25%); partial response (8,3%); stable disease (8,3%); progression (8,3%); deceased (41,7%). In our experience most patients needed dose increment, even over published recommendations (maximum ISA-

sulphate needed: median—10,36mg/kg/day; IQR:7,84—20,88). Moreover, we observed IPC variation without posology changes.

Conclusions/Learning Points: Therefore, we recommend IPC periodical monitoring in paediatric patients, since pharmacokinetics and weight-adjusted doses might vary from adult-use.

EP004 / #372

Topic: AS01. Antimicrobials / AS01.b. Resistance

CLINICAL EXPERIENCE OF TIGECYCLINE IN PEDIATRIC AND NEONATAL PATIENTS IN A TERTIARY CARE HOSPITAL IN PAKISTAN.

E-Posters

E-POSTER VIEWING

Falak Abro, Syeda Anum, Nazia Bibi, Fozia Baloch
Aga Khan University Hospital, Pediatrics And Child Health, Karachi, Pakistan

Title of Case: Clinical experience of Tigecycline in pediatric and neonatal patients in a tertiary care hospital in Pakistan.

Background: The rise of Multi-drug resistant (MDR) and Extensively drug-resistant (XDR) infections has led to fewer choices of antimicrobials in the pediatric population. Tigecycline can be used as a combination therapy in pediatrics and neonatal populations. The aim was to review the experience of tigecycline use for multidrug-resistant (MDR) and extended drug-resistant (XDR) gram-negative infections and the microbiological and clinical outcomes in pediatrics and neonates.

Case Presentation Summary: Methodology: A retrospective chart review was performed for twenty-eight pediatrics and neonatal patients who received tigecycline at least 48 hours after a report of antimicrobial susceptibility for MDR and XDR infections from different culture sites. The outcomes observed were microbial eradication, clinical improvement, mortality, and adverse effects in children. Results: Twenty-five (89%) patients received targeted tigecycline treatment with combination antibiotics against culture-proven gram-negative organisms, and three (10.7%) received empiric tigecycline treatment. Male predominance was observed in 19 (68%). The median duration of tigecycline therapy was 11 days. The most frequent isolated pathogens were E-coli 8 (28.6%), Acinetobacter 3 (10.7%), Serratia 7 (25%), Klebsiella 8 (28.6%), Raoultella 2 (7.1%), and all of them were carbapenem-resistant. Microbiological eradication was achieved in 15 (75%) children with a median duration of 2.5 (2-3) days. The mortality rate of patients was 11 (39.3%), The highest rate of mortality was associated with bloodstream infections, although there was no statistical significance associated.

Learning Points/Discussion: - The use of tigecycline in the pediatrics population has been reserved as the last resort for infection caused by MDR and XDR organisms. - More prospective and controlled trials are needed to determine the relationship between dosing and pharmacokinetic parameters in children.

EP005 / #1460

Topic: AS01. Antimicrobials / AS01.b. Resistance

MULTIRESISTANT MICROORGANISMS IN NEWBORNS – AND NOW?

E-Posters

E-POSTER VIEWING

Sara Araújo¹, Inês Azevedo¹, Inês Oliveira², Ana Teixeira², Marta Pinheiro¹

¹Centro hospitalar Entre Douro e Vouga, Paediatric, Santa Maria da Feira, Portugal, ²Centro Materno-Infantil do Norte, Centro Hospitalar Universitário do Porto, Paediatrics, Porto, Portugal

Title of Case: MULTIRESISTANT MICROORGANISMS IN NEWBORNS – AND NOW?

Background: Urinary tract infection (UTI) is one of the most common bacterial infections in children. During the neonatal period, this infection takes a greater risk of systemic involvement and may be associated with urinary tract malformations.

Case Presentation Summary: Case 1: Male newborn admitted at 14 days of age for urosepsis caused by multisensitive *Klebsiella pneumoniae*. Renal ultrasound showed right hydronephrosis. Completed ten days of Ampicillin and Cefotaxime. Readmitted at one month for febrile UTI caused by the same agent, having completed treatment with Cefuroxime and started prophylaxis. Two subsequent admissions for UTI caused by ESBL *K. pneumoniae*, requiring treatment with Ertapenem. At two months, voiding cystourethrography (VCUG) was performed, showing grade IV vesicoureteral reflux (VUR) on the right and grade III on the left. Currently awaiting circumcision, with follow-up in nephrology consultation. Case 2: Male newborn hospitalized at 22 days of life for urosepsis caused by *Enterobacter sakazakii* (susceptible to Cephalosporins in vitro). Renal ultrasound showed no changes and completed treatment with Ampicillin, Cefotaxime and Gentamicin. Readmission at one month for suspected febrile UTI caused by resistant microorganism and treated with Ertapenem. Third hospitalization at two months, already under prophylaxis, with isolation of ESBL *K. pneumoniae*, treated with Ertapenem. Submitted to VCUG, diagnosing bilateral grade III VUR. Currently awaiting circumcision, with follow-up in nephrology consultation.

Learning Points/Discussion: The majority of UTI cases during the first year of life occur in males due to typical bacteria. The presence of nephro-urological pathology may increase the risk of infection caused by less common agents. We pretend to highlight the impact of antibiotic pressure on the pathogenic flora, determining the emergence of multiresistant microorganisms in the pediatric age, difficult to treat properly.

EP006 / #1406

Topic: AS01. Antimicrobials / AS01.b. Resistance

ANTIMICROBIAL RESISTANCE PATTERNS OF ESCHERICHIA COLI, KLEBSIELLA PNEUMONIAE AND PROTEUS MIRABILIS ISOLATES FROM PAEDIATRIC URINARY TRACT INFECTIONS IN GREECE, DURING 2015-2021

E-Posters

E-POSTER VIEWING

Kirkira Banou^{1,2}, Malamati Mika², Sophia Zisi², Nicki Petropoulou¹, Kalliopi Spyridopoulou², Giorgos Paradeisis², Levantia Zachariadou²
1"Agia Sophia", Children's Hospital, Microbiology, Athens, Greece, 2"Agia Sophia" Children's Hospital, Microbiology, Athens, Greece

Backgrounds: Antibiotic sensitivity patterns of the main uropathogens E. coli, K. pneumonia and P. mirabilis isolated from paediatric urinary tract infections (UTI) during 2015-2021, were tested. The aim of this study is the surveillance of rates and type of resistance profiles over the years and the suggestion for empirical antibiotic treatment of UTIs in children.

Methods: During 2015-2021, antibiotic susceptibility in 5,425 isolates (4,307 E. coli, 633 K. pneumoniae and 485 P. mirabilis from urine cultures of hospitalized(H) and non-hospitalized(NH) children, 77.0% of all isolated uropathogens, was evaluated. Identification: VITEK2 (Biomerieux®), RapID-ONE (Thermo-Scientific™ Remel™). Sensitivity testing: Kirby-Bauer (BIORAD disks), VITEK2 and graded antibiotic concentration strips (MIC-Test Strips™-Liofilchem®).

Results: E. Coli: 42.0% sensitivity to all antibiotics tested (H: 38.1%/NH: 48.3%). Resistance (%) (H/NH): ampicillin (20.9/20.8), amoxicillin/clavulanic acid (9.8/4.4), 1st- and 2nd-generation-cephalosporines (18.3/9.8) and (16.0/9.7) respectively, co-trimoxazole (3.2/4.6), aminoglycosides (12.6/7.8), ESBL (13.2/7.2), with an upward trend over the years. All strains were sensitive to nitrofurantoin. K. pneumoniae resistance (%) (H/NH): amoxicillin/clavulanic (29.7/13.6), 1st- and 2nd-generation-cephalosporines (48.7/22.0) and (43.7/21.2) respectively, co-trimoxazole (51.1/25.7), ESBL (27.3/12.9). Vim carbapenemases were also detected in 4.6% of clinical isolates with an ascending tendency. P. mirabilis resistance (%) (H/NH): ampicillin (14.3/21.8), amoxicillin/clavulanic acid (5.5/3.3), 1st- and 2nd-generation-cephalosporines (5.5/6.0) and (6.0/4.3) respectively, co-trimoxazole (18.1/18.5), ESBL: (1.0/1.7).

Table 1. ESBL resistance rates of *E. coli*, *K. pneumoniae* and *P. mirabilis* isolates.

| Year (s) | ESBL (%) | | | | | |
|------------------|---|----------------------|---------------------|---|----------------------|---------------------|
| | Isolates from hospitalized children (N) | | | Isolates from non-hospitalized children(NH) | | |
| | <i>E. coli</i> | <i>K. pneumoniae</i> | <i>P. mirabilis</i> | <i>E. coli</i> | <i>K. pneumoniae</i> | <i>P. mirabilis</i> |
| 2015 | 8.7 | 15.4 | 0.0 | 3.0 | 9.5 | 0.0 |
| 2016 | 10.7 | 23.1 | 0.0 | 6.8 | 0.0 | 0.0 |
| 2017 | 9.7 | 22.2 | 0.0 | 6.7 | 25.9 | 0.0 |
| 2018 | 12.3 | 40.1 | 0.0 | 6.6 | 12.5 | 2.2 |
| 2019 | 16.1 | 36.0 | 5.3 | 10.2 | 15.8 | 7.4 |
| 2020 | 20.5 | 21.7 | 5.0 | 13.7 | 6.7 | 4.0 |
| 2021 | 15.7 | 25.0 | 0.0 | 5.6 | 8.3 | 3.4 |
| 2015-2021 | 13.2 | 27.3 | 1.0 | 7.2 | 12.9 | 1.7 |

Conclusions/Learning Points: 20.9% of clinical and 20.8% of community UTI *E. coli* isolates was resistant to ampicillin, whereas ESBL-resistance was 13.2% and 7.2% respectively. ESBL-resistance complicates treating of *K.pneumoniae* hospital urine infections. Amoxicillin/clavulanic acid, 2nd generation cephalosporins and aminoglycosides are suggested for the empirical treatment of paediatric community UTI and nitrofurantoin for *E.coli* UTI prophylaxis.

EP007 / #968

Topic: AS01. Antimicrobials / AS01.b. Resistance

MULTI-DRUG RESISTANT GRAM-NEGATIVE BLOOD STREAM INFECTIONS AND PREVALANCE OF CARBAPENEM RESISTANCE IN PEDIATRIC PATIENTS IN A TERTIARY CARE CANCER CENTRE

E-Posters

E-POSTER VIEWING

Sanjay Biswas, Gaurav Salunke

TATA MEMORIAL HOSPITAL, Microbiology, MUMBAI, India

Backgrounds: Bloodstream infections (BSIs) in children are potentially life-threatening and are associated with higher healthcare costs and more extended hospital stay. The pattern of blood stream infections has been changing over the years. Monitoring trends and antimicrobial susceptibility patterns is crucial in making decisions of empirical therapy in critically ill and neutropenic patients with sepsis. Gram negative sepsis has always predominated in oncology patients. During the last several decades, the prevalence of multidrug- resistant organisms has increased steadily. MRSA was followed by vancomycin resistant enterococci, extended spectrum beta lactamase and metallo-betalactamase producing gram negative organisms. These multidrug- resistant organisms are prevalent in long term care facilities as well as in out patients. Infections represent one of the most important causes of morbidity and mortality in patients undergoing therapy for cancers.

Methods: A total of 27316 blood samples from 3261 patients were received in the Dept of Microbiology, Tata Memorial Center, Mumbai, India during January 2019 to November 2021. All the samples were processed as per routine microbiological procedures and antimicrobial susceptibility testing was performed as per CLSI guidelines.

Results: E. coli was the commonest microorganism isolated followed by Klebsiella pneumoniae, P. aeruginosa, Acinetobacter sp and Enterobacter sp. Ceftriaxone-Sulbactam-EDTA (93.9%) was the most susceptible antibiotic followed by fosfomicin (85.9%), aminoglycosides (53.4%), cefoperazone-sulbactam (37.7%) minocycline (40.5%) and piperacillin-tazobactam (36.4%). Carbapenem resistance was detected in 92.2% .

Conclusions/Learning Points: The increasing prevalence of CRO infections represents a major threat to cancer patients. With the high mortality of CRO infections and increasing resistance to available antibiotics, it is urgent for the medical community to develop new and effective therapeutic strategies. Robust anti-microbial stewardship is the need of the hour.

EP008 / #1047

Topic: AS01. Antimicrobials / AS01.b. Resistance

GRAM NEGATIVE BACTEREMIA IN BRITISH COLUMBIA'S CHILDREN'S HOSPITAL: A PROSPECTIVE STUDY 2019-2021

E-Posters

E-POSTER VIEWING

Anne Deasy¹, Adriana Cabrera¹, Naomi Futhey¹, Ashley Roberts², Kristopher Kang³, Peter Tilley⁴, James Zlosnik¹, Manish Sadarangani¹

¹BC Children's Hospital, Vaccine Evaluation Center, Vancouver, Canada, ²University of British Columbia, Division Of Infectious Diseases, Department Of Pediatrics, Vancouver, Canada, ³BC Children's Hospital, Department Of Pediatrics, University Of British Columbia, Vancouver, Canada, ⁴University of British Columbia, Department Of Pathology And Laboratory Medicine, Faculty Of Medicine, Vancouver, Canada

Backgrounds: In Canada, 31-39% of pediatric bacteremia is caused by Gram negative organisms, most commonly Escherichia coli, Klebsiella and Enterobacter. There is an increase in highly antibiotic resistant Gram negative bacteria identified over the last decade, including among children with no known risk factors for antibiotic resistance. Objective: Describe the clinical characteristics and outcomes of children with Gram negative bacterial infections attending BCCH between 2019-2021.

Methods: This study included children attending BCCH aged ≤18 years who were diagnosed with any Gram negative bacteremia. Multi drug resistant (MDR) organisms were classified as ceftriaxone-resistant Enterobacteriaceae, carbapenem-resistant Enterobacteriaceae, Enterobacteriaceae resistant to at least two of fluoroquinolones, aminoglycosides or trimethoprim, or non-Enterobacteriaceae resistant to at least three of fluoroquinolones, aminoglycosides, carbapenem, ceftazidime or piperacillin-tazobactam. Ethics approval was obtained. Medical records were reviewed for eligible patients.

Results: There were 40 patients with gram-negative bacteremia. Escherichia coli (n=15, 38%), Klebsiella pneumoniae and K. oxytoca (n=11, 28%), Pseudomonas aeruginosa (n=5, 13%) were the most common bacteria in this cohort. Overall, 9/40 isolates (23%) were defined as MDR. Most patients were male (n=26, 65%). Ten (25%) patients were neonates in NICU, of which 9 had a history of prematurity. The most common localizing infection identified was urinary tract infections (7/40, 18%). Febrile neutropenia was associated with 8 cases (20%) and 14 patients (35%) were on immunosuppressant medications at the time of bacteremia. Overall case-fatality was 5/40 (13%). In 3 patients (8%), death was directly attributed to Gram negative infection.

Conclusions/Learning Points: Gram negative bacteremia continues to cause significant morbidity and mortality in the pediatric population. Ongoing surveillance to understand trends in antibiotic resistance mechanisms and to identify clinical risk factors for antibiotic-resistant infections will help guide ongoing antimicrobial stewardship efforts.

EP009 / #856

Topic: AS01. Antimicrobials / AS01.b. Resistance

ASSOCIATION OF BETA-LACTAM ANTIMICROBIAL'S EXPOSURE WITH CARBAPENEM RESISTANT PSEUDOMONAS AERUGINOSA INFECTION RELATIVE TO CONTROL PATIENTS: A CUMULATIVE META-ANALYSIS

E-Posters

E-POSTER VIEWING

Prity Rani Deshwal, Muskan Aggarwal, Nalla Surender Reddy, Raisa Fathima, Pramil Tiwari
National Institute of Pharmaceutical Education and Research (NIPER), Mohali, INDIA, Department Of
Pharmacy Practice, Mohali, India

Backgrounds: The carbapenems are the most effective antimicrobial agents against severe *Pseudomonas aeruginosa* nosocomial infections. Therefore, increased rates of carbapenem resistant *P. aeruginosa* (CRPA) is a serious public threat. Revealing risk of inappropriate exposure of different antimicrobials in resistant *P. aeruginosa* infection could help in enlightening the effective approach towards the usage of antimicrobials in vulnerable patients with CRPA infection. This study aims to investigate the association between exposure of beta-lactam antimicrobials and CRPA infection relative to control patients.

Methods: The MEDLINE/PubMed and OVID/Embase databases were used to search case-control and cohort studies in English language which reported antimicrobial's exposure as risk factors specifically for CRPA infection. The pooled odds ratios (ORs) were calculated using a random-effect model, and forest plots from a cumulative meta-analysis method were used for a better presentation of how pooled ORs changed as updated evidence accumulated.

Results: A total of 25 studies comprising 7039 participants were included for cumulative meta-analysis. A consistent trend was found between development of CRPA infection and exposure of beta-lactam antimicrobials: carbapenems [OR 7.60], imipenems [9.81], ampicillins [OR 1.66], piperacillins [OR 2.82], penicillins [OR 1.42], cephalosporins [OR 1.88], 1st gen cephalosporins [OR 1], 3rd gen cephalosporins [OR 1.92], 4th gen cephalosporins [OR 1.7] and beta lactamase inhibitors [OR 1.96]. Further, exposure of other antimicrobial agents like quinolone [OR 2.35], ciprofloxacin [OR 1.66], aminoglycoside [OR 2.17], amikacin [OR 3.11], glycopeptides [OR 3.02] and vancomycin [OR 3.26], were also found to be positively associated with development of CRPA infection.

Conclusions/Learning Points: Exposure of all kinds of beta lactams is significantly associated with development of CRPA infection. These findings provide an imputes to take a more active approach while using beta-lactam antimicrobials in patients with resistant *P. aeruginosa* infections.

EP012 / #1355

Topic: AS01. Antimicrobials / AS01.b. Resistance

ANTIMICROBIAL RESISTANCE OF PEDIATRIC UROPATHOGENS IN LIMASSOL, CYPRUS

E-Posters

E-POSTER VIEWING

Chrystalla Ioannou¹, Stella Mazeri², Nikoletta Chrysanthou¹, Maria Koliou^{3,4}

¹Limassol General Hospital, Paediatrics, Limassol, Cyprus, ²University of Edinburgh, Roslin Institute, Royal (Dick) School Of Veterinary Medicine, Scotland, United Kingdom, ³University of Cyprus, Medical School, Nicosia, Cyprus, ⁴Archbishop Makarios Hospital, Paediatrics, Nicosia, Cyprus

Backgrounds: Urinary tract infections are important bacterial infections especially in infants and young children. Increasing resistance of uropathogens to many commonly used antibacterials in many countries is a cause of concern. The aim of this study was to investigate bacterial pathogens and their resistance patterns, involved in Urinary tract infections (UTIs) in children admitted to hospital with a first episode of UTI

Methods: We retrospectively analysed the resistance profile of bacteria isolated from the urine cultures of children admitted for a first episode of UTI to Limassol General hospital in Limassol, the second largest city of Cyprus between 2010 and 2020

Results: During the study period, a total of 171 medical records of children less than 15 years of age were reviewed. 94 of them were boys and 77 were girls. The mean age of children was 17.5 months and median age 6 months. Median age in boys was 3 months while in girls 11.5 months, with statistically significant difference (Mann-Whitney test, p value = 1.6×10^{-9}). *Escherichia coli* (E.coli) was the most frequent uropathogen isolated (73.8%) followed by *Klebsiella pneumoniae* (12.8%) and *Proteus mirabilis* (3.5%). Antimicrobial resistance of E. coli was highest to ampicillin (44.6%) and trimethoprim-sulfamethoxazole (23.3%), followed by cefuroxime (9.9%), cefotaxime (9.2%), amoxicillin-clavulanate (8.5%), gentamicin (2.6%), nitrofurantoin (1.9%). No isolate was resistant to meropenem.

Conclusions/Learning Points: E. coli was found to be the most frequent uropathogen. While ampicillin and cotrimoxazole had the highest resistance rates against E. coli isolates, UTIs may still be empirically treated with cefuroxime or amoxicillin-clavulanate. UTI surveys need to be performed every few years in order to monitor antimicrobial resistance patterns and update practices on empirical use of antibacterials.

EP013 / #527

Topic: AS01. Antimicrobials / AS01.b. Resistance

MRSA INCIDENCE & ANTIBIOTIC RESISTANCE TRENDS IN A GREEK PAEDIATRIC HOSPITAL OVER THE YEARS 2017-2021

E-Posters

E-POSTER VIEWING

Maria Daskalaki¹, Efstathia Staikou¹, Ioanna Papazaharia¹, Eleni Dimara², Paraskevi Korovessi³, Vassilis Tsagris³, Stavroula Kostaridou³, [Patra Koletsj](#)³

¹Penteli Children's Hospital, Biopathology Department, Athens, Greece, ²Penteli Children's Hospital, Infection Control Nurse, Penteli, Greece, ³Penteli Children's Hospital, Paediatrics, Athens, Greece

Backgrounds: Staphylococcus aureus (S.a) is a major pathogen responsible for a wide range of infections, most commonly of the skin and soft tissue. In the last decade, Greece has been experiencing an epidemic of MRSA isolates among paediatric patients therefore, antibiotic classes other than b-lactams have been widely used. We aimed to identify the trend of MRSA isolates incidence and resistance patterns during the last five years.

Methods: S.a positive cultures and MRSA isolates were identified in the Microbiology Department from patients referred to outpatient (OP) and inpatient departments (Paediatrics[S1], Orthopedics, Surgical ward and PICU) of our Hospital between 01/01/2017 and 31/12/2021. Clinical and microbiological data were collected. MRSA were defined as those cases with ceftazidime-resistant isolates by the disc-diffusion method.

Results:

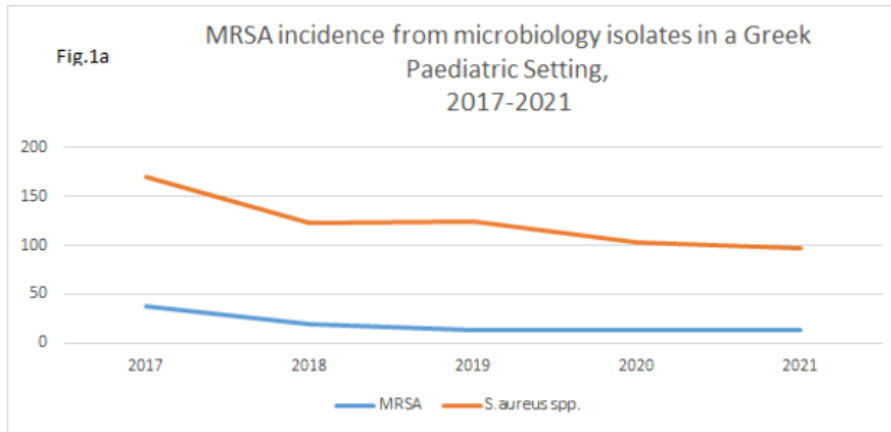

ANTIBIOTIC RESISTANCE OF MRSA STRAINS

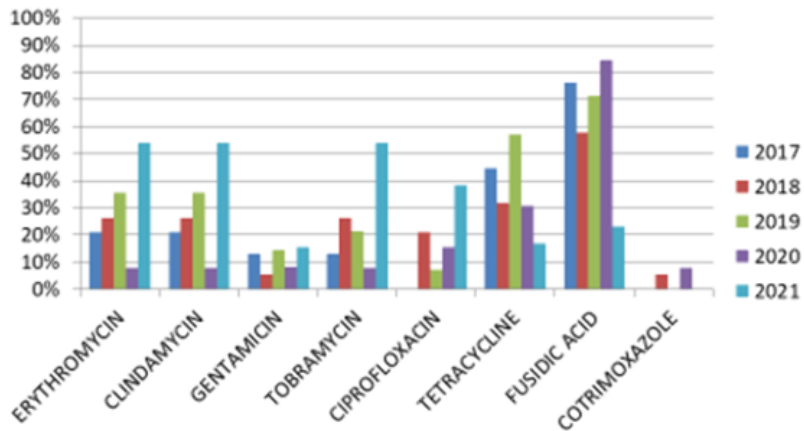

A total of 97 MRSA isolates out of 618 samples (15.7%) positive for S.a have been identified (Figure 1a). 77.3% were from skin and soft tissue infections (SSTIs). There was only one positive blood culture. 11.3% were from neonates. There was no male predominance ($p=0.2$). The distribution of samples were 48% from OP, 22.7% from paediatric inpatients and 15.7% were from PICU samples (mainly deep bronchial secretions and skin carriage surveillance samples), whereas numbers were low for the Orthopaedic and Surgical ward (9.3% and 4,1% respectively). Antimicrobial resistance trends to non-beta-lactams antibiotic classes are demonstrated in Figure 1b. There were no isolates resistant to mupirocin, vancomycin, teicoplanin or linezolid.

Conclusions/Learning Points: Community-related MRSA infections incidence, although relatively low compared to other studies performed in Athens, remains a big concern in Greek settings. Mupirocin, Cotrimoxazole and rifampicin remain acceptable alternatives whereas there should be caution with clindamycin, a broadly used empiric agent against suspected MRSA infections.

EP014 / #398

Topic: AS01. Antimicrobials / AS01.b. Resistance

ANTIMICROBIAL SUSCEPTIBILITY OF GRAM NEGATIVE BACTERIAL ISOLATES CAUSING URINARY TRACT INFECTIONS

E-Posters

E-POSTER VIEWING

Nazla Luthfee¹, Andrew Pollard², Dominic Kelly², Nicole Stoesser², Ushma Galal²

¹Indira Gandhi Memorial Hospital, Qid, Male', Maldives, ²Oxford University, Continuing Medical Education, JA, United Kingdom

Backgrounds: The study was undertaken to determine the antimicrobial resistance patterns of Gram negative bacterial isolates obtained from urine cultures processed in Indira Gandhi Memorial Hospital (IGMH), Maldives. IGMH is the main reference center in the island nation of Maldives.

Methods: The study includes; a retrospective audit of urine culture results collected over 16 months (1st January 2016 to 2nd May 2017) and a cross-sectional study in which isolates fitting the study inclusion criteria were stored for 5 months (8 th December 2016 to 2nd May 2017) and a selected subset was subjected for whole genome sequencing (WGS), with a particular focus on determining prevalence of extended-spectrum beta-lactamase (ESBL) resistance prevalence.

Results: As phenotypic ESBL production was not checked in the laboratory and taking cefixime non-susceptibility as an indicator, for *E. coli* and *Klebsiella* species; 33.5% (628/1872) and 40.6% (352/866) samples from out-patients and 72% (131/182) and 79.8% (174/218) samples from inpatients were non-susceptible. Data from WGS showed that some of the most common sequence types were associated with resistance to multiple groups of antibiotics. *E. coli* (n=128) ST- 131 (n= 18) and *Klebsiella* species (n=118); ST-147 (n=12), ST-395 (n=8) and ST-15 (n=7) were associated with above 70% non-susceptibility to cefixime and ciprofloxacin. Carbapenemase genes associated with *Klebsiella* species (n=20) were NDM 1 (n=11), NDM 5 (n=1), OXA 231 (n=7) and OXA 181 (n=1) and in *E. coli* NDM1 (3/5) and NDM5 (2/5). The highest risk of antibiotic non-susceptibility was associated with age \geq 65 years, male gender and inpatient status.

Conclusions/Learning Points: The study finding point to high burden of antimicrobial resistance of Gram negative isolates in the community and the urgent need to implement risk identification and risk modification strategies.

EP015 / #1227

Topic: AS01. Antimicrobials / AS01.b. Resistance

ETIOLOGICAL STRUCTURE AND ANTIBIOTIC RESISTANCE PATTERN OF URINE CULTURES IN ARMENIAN PEDIATRIC CLINIC

E-Posters

E-POSTER VIEWING

Emma Shahinyan¹, Hrachuhi Ghazaryan¹, Irina Mamyanyan¹, Tigranuhi Hovhannisyan¹, Araksya Grigoryan², [Lilit Marutyan](#)¹

¹Wigmore Clinic, General Pediatric, Yerevan, Armenia, ²Yerevan State Medical University after M. Heratsi, Clinical Diagnostic Laboratory, Yerevan, Armenia

Backgrounds: Pediatric urinary tract infections (UTIs) are common worldwide and may cause permanent kidney damage with related consequences. Overuse of antibiotics leads to increasing resistance, particularly multidrug resistance (MDR). Continuous regional surveillance of antibiotic resistance (AR) is crucial for proper selection of antibiotics and effective treatment of UTIs. Our study aims to demonstrate epidemiology of UTIs and AR pattern of urine cultures in Armenian pediatric clinic.

Methods: We performed a retrospective laboratory-based study and analyzed urine cultures of children below 18 y/o, who primarily had symptomatic UTIs. 144 urine samples were referred by a caring pediatrician during one year (December 2020-21). Positive monocultures were identified in 93 cases(64.6%), no growth in 18(12.5%), 33(22.9%) were excluded due to contamination. Sensitivity test was performed to at least 5 antibiotic groups (β -lactams, cephalosporines, quinolones, carbapenems, macrolides, nitrofurans, antifolate agents).

Results: Among monocultures there were 26/93 febrile(27.96%) and 67/93 afebrile(72.04%) UTI cases, 79/93 females(84.95%) and 14/93(15.05%) males. E.Coli was the leading pathogen 76/93(81.72%), followed by Klebsiella spp. 5/93(5.38%), Enterococcus spp. 5/93(5.38%), Alcaligenes faec. 3/93(3.23%), Proteus spp. 2/93(2.15%), Pseudomonas aer. 1/93(1.08%), Staph. sapr. 1/93(1.08%). In monocultures 25/93 specimens(26.88%) were sensitive to all studied antibiotic groups; 34/93(36.56%) showed multidrug-resistance to at least 3 groups; 34/93(36.56%) were resistant to a single antibiotic group: antifolate agents 15/93(16.13%), carbapenems 8/93(8.6%), quinolones 6/93(6.45%), nitrofurans 4/93(4.3%), macrolides 1/93(1.08%).

Conclusions/Learning Points: Epidemiology of pediatric UTIs at our clinic is similar to developing countries. E.Coli remains the leading cause. Increasing AR is a challenge in Armenia as long as antibiotics are overused through their prescription, self-medication and over-the-counter availability.

EP017 / #1293

Topic: AS01. Antimicrobials / AS01.b. Resistance

ANTIBIOTIC SUSCEPTIBILITIES OF PATHOGENS CAUSING HEALTHCARE-ASSOCIATED INFECTIONS IN PEDIATRIC WARDS

E-Posters

E-POSTER VIEWING

Irem Yılmaz Akpınar¹, Özden Türel²

¹Bezmialem Vakıf University Faculty of Medicine, Department Of Pediatrics, Istanbul, Turkey, ²Bezmialem Vakıf University Faculty of Medicine, Department Of Pediatric Infectious Diseases, Istanbul, Turkey

Backgrounds: Healthcare-associated infections (HCAs) are defined as infections that develop during the care of the patient in the healthcare institution and are not present at the time the patient applies to the healthcare institution or are not in the incubation period. In this study, we aimed to determine the causes and susceptibility pattern of HCAs among patients hospitalized in pediatric wards in a tertiary care center between 2016 and 2020.

Methods: Patients who were treated at Bezmialem Vakıf University Pediatrics Departments and diagnosed with HCAI were included in this study between January 2016 and December 2020. The data of all patients were obtained through the hospital information management system. The microbiological results of clinical isolates and the clinical course of patients with HCAs were recorded.

Results: In a five-year retrospective evaluation, 297 microbiologically proven HCAs were detected. Gram-negative bacteria constituted 64.9% of the pathogens while the frequencies of gram-positive bacteria and fungi were 23.4% and 11.7%, respectively. Methicillin resistance was detected in 92% of CoNS and 57% of Staphylococcus aureus strains. 50% of the Escherichia coli and 30% of Klebsiella spp. were ESBL positive. While no carbapenem resistance was detected in E. coli strains, 15% of Klebsiella spp, 20% of P. aeruginosa, 60% of Acinetobacter baumannii strains were found to be carbapenem-resistant. 3.2% of Klebsiella strains were also resistant to colistin. None of the P. aeruginosa or A. baumannii strains were colistin resistant.

Conclusions/Learning Points: Continuous surveillance regarding patient profiles, the microorganisms that make up the hospital flora and their resistance properties, the distribution and frequency of HCAI in each department will enable the development of correct empirical treatment approaches against HCAI.

EP019 / #517

Topic: AS01. Antimicrobials / AS01.c. Pharmacology

ANTIBIOTIC TREATMENT OF SORE THROAT BY PRIMARY CARE PHYSICIANS

E-Posters

E-POSTER VIEWING

Oksana Boyarchuk, Oksana Mochulska, Yaroslav Savulyak

I.Horbachevsky Ternopil National Medical University, Department Of Children's Diseases And Pediatric Surgery, Ternopil, Ukraine

Title of Case: Antibiotic treatment of sore throat by primary care physicians

Background: Sore throat is one of the most common reasons to refer to a primary care physician (either a pediatrician or a general practice physician). About 20–30% of pharyngitis cases in children are caused by bacterial infections, among which group A β hemolytic streptococci (GAS) rank first. The aim of the study was to evaluate whether primary care physicians select correct medication and duration of antibiotic therapy for streptococcal pharyngitis in children, and to identify ways to improve their decision-making process.

Case Presentation Summary: We conducted a survey among primary care physicians on evaluation of diagnosis and management of pharyngitis in children. Overall, 139 pediatricians responded to participate in the study. Among the participants, 79 were pediatricians and 60 - general practitioners. Antibiotic therapy for the treatment of pharyngitis was used in selected cases by 121 (87.1%) of the respondents. The majority of those prescribing antibiotic therapy prescribed penicillin/aminopenicillin antibiotics, including in combination with a beta lactamase inhibitor sulbactam or clavulonate (89.9%). Amoxicillin was selected as the first choice antibiotic by 83 (59.7%) of those prescribing antibiotic therapy. However, a large number of physicians 35 (25.9%) chose a second-line antibiotic (amoxicillin/clavulanate) and 2.8% of physicians chose third-generation cephalosporins (ceftriaxox, cefotaxime). Only 50 (36.0%) of those prescribing antibiotic therapy selected its correct duration for 10 days.

Learning Points/Discussion: The results of the study showed a wide variation in the knowledge by primary care physicians about appropriate strategies in prescribing antibiotics for the treatment of a sore throat in children. These results underscore the need to improve awareness of physicians, especially general practitioners about correct management of patients with acute pharyngitis.

EP021 / #370

Topic: AS01. Antimicrobials / AS01.c. Pharmacology

INVESTIGATING FOURIER-TRANSFORM INFRARED SPECTROSCOPY AS A RAPID, PORTABLE AND MINIMALLY INVASIVE METHOD FOR MONITORING AMINOGLYCOSIDE DOSING IN CHILDREN.

E-Posters

E-POSTER VIEWING

Daniel Owens¹, Nathan Seto², David Rowe³, Suzanne Parker⁴, Katrina Cathie¹, Goran Mashanovich³, James Wilkinson³, Saul Faust⁵

¹University Hospital Southampton, NihR Clinical Research Facility, Southampton, United Kingdom, ²University of Southampton, Faculty Of Medicine, Southampton, United Kingdom, ³University of Southampton, Zepler Institute For Photonics And Nanoelectronics, BJ, United Kingdom, ⁴University of Queensland, Uq Centre For Clinical Research, Faculty Of Medicine, Brisbane, Australia, ⁵University of Southampton, NihR Clinical Research Facility, Southampton, United Kingdom

Backgrounds: Aminoglycoside antimicrobials are routinely measured to assess for toxic and therapeutic levels. These measurements require large sample volumes and processing times which are suboptimal for critically unwell children, especially preterm infants, who would benefit from rapid analysis and microsampling (<50 µL). Fourier-transform infrared spectroscopy (FTIR) allows label-free detection of medications in biological fluids through the characterisation of molecular bond vibrations. Analysis within 2-3 minutes can be performed directly in whole blood without further processing and requires finger or heel prick microsamples. These qualities make it a good candidate for further investigation as a method for measuring aminoglycoside levels in critically unwell children.

Methods: Known concentrations of tobramycin, gentamicin and vancomycin were serially diluted in blood. Concentrations of tobramycin were measured in blood from 100 – 40,000 mg/L. Gentamicin was measured in blood with concentrations from 500-20,000 mg/L. Vancomycin was measured in whole blood with concentrations from 1 – 300 mg/L. Mid-infrared spectra were measured using an Alpha II FTIR spectrometer (Bruker, USA). Concentration was quantified by the relative magnitude of spectral peaks.

Results:

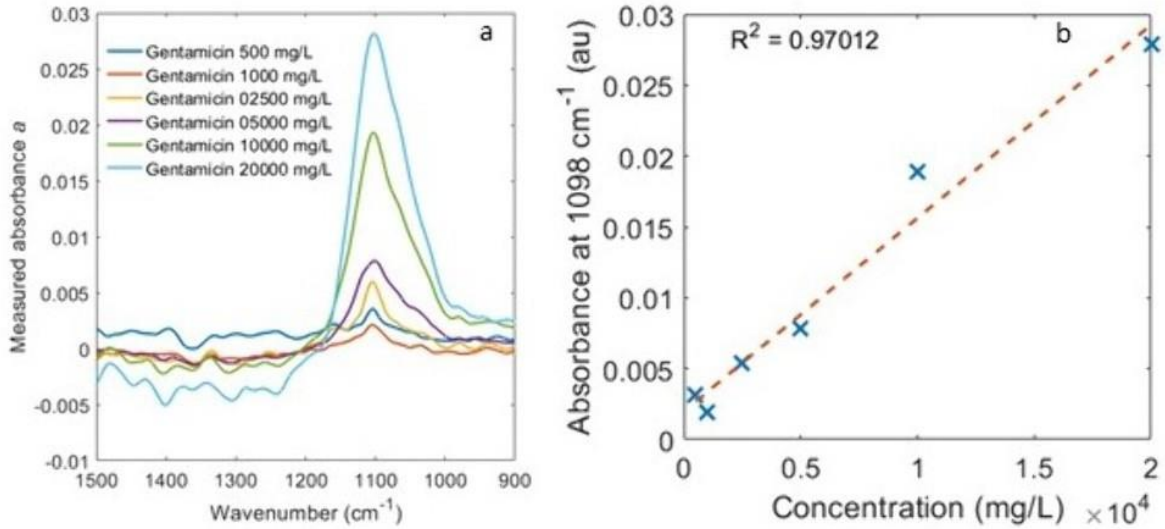

Figure 1 (a) absorbance spectra for dilutions of Gentamicin in whole blood and (b) absorbance at 1098 cm^{-1} with respect to gentamicin concentration.

The provisional lower limit of detection (LLOD) was 500 mg/L for gentamicin and tobramycin and 1 mg/L for vancomycin (1 – 100 mg/L is the range of clinical interest). Each drug demonstrated a positive concentration – response with peak magnitude. The concentration – response correlation (R^2) for tobramycin was 0.958, 0.970 for Gentamicin (figure attached) and 0.953 vancomycin.

Conclusions/Learning Points: FTIR can reliably detect aminoglycoside levels in fluid including whole blood. Further work is needed to improve the sensitivity of the method using chemical extraction and microfluidic techniques. Once the LLOD is improved a formal bioanalytical validation study, including measuring clinical samples in comparison with current gold standards, will be undertaken.

EP022 / #697

Topic: AS01. Antimicrobials / AS01.c. Pharmacology

CHALLENGES IN DIAGNOSIS, MANAGEMENT AND TREATMENT OF ISONIAZID-INDUCED DRESS SYNDROME

E-Posters

E-POSTER VIEWING

Elena Rodríguez-Barber¹, Anna Cegarra-Besora¹, Èlia Domènech-Marsal¹, Alba González-Aumatell¹, Marta Azuara-Robles¹, Yanina Jurgens², Maria Méndez¹, Carlos Rodrigo¹, Clara Carreras-Abad¹

¹University Hospital Germans Trias i Pujol, Autonomous University of Barcelona, Pediatric Infectious Diseases Unit, Department Of Pediatrics, Barcelona, Spain, ²University Hospital Germans Trias i Pujol, Autonomous University of Barcelona, Department Of Allergology, Barcelona, Spain

Title of Case: Challenges in diagnosis, management and treatment of isoniazid-induced DRESS syndrome

Background: A 17-year-old Bolivian male, resident in Spain for 2 years, with no past medical history, presented with a 4-day history of haemoptysis. A diagnosis of drug-sensitive pulmonary tuberculosis (TB) was established and first line treatment with isoniazid, rifampicin, pyrazinamide and ethambutol was started.

Case Presentation Summary: Five weeks later, he presented with fever, skin rash with palms and soles involvement, malaise, hyporexia and vomiting. On examination, multiple laterocervical enlarged lymph nodes, mild conjunctival jaundice, two aphthae in the lower lip and bilateral auricular edema were found (figure 1). A laboratory exam revealed hypereosinophilia (1520 eosinophils/ μ L) and abnormal liver function (AST 1684U/L, ALT 1157U/L, bilirubin 2.78mg/dL, prothrombin ratio 50%) requiring treatment with vitamin K. DRESS syndrome secondary to anti-TB treatment was suspected withdrawing all 4 TB-drugs and starting corticosteroids (2mg/kg/d) for a month. Screening for imported diseases showed a positive serology for *Strongyloides stercoralis*, thus treatment with ivermectin was started before initiation of corticosteroids. DRESS symptoms progressively disappeared and a second line treatment with levofloxacin, linezolid, clofazimine and streptomycin was started seven days later for 2 months. A lymphocyte transformation test (LTT) showed reaction to isoniazid, being able to reintroduce rifampicin without adverse events. His clinical evolution was good, and he continued with a 2-drug regimen with levofloxacin and rifampicin. At present, he is on the 7th month of treatment and medication is well tolerated.

Learning Points/Discussion: This case report shows the challenges of managing pulmonary TB when first line treatment is not possible. The LTT is highly useful in the diagnosis of severe drug reactions minimizing treatment interruption, without compromising efficacy. Strengthening screening for infectious diseases among newly arrived migrants is key to start prompt treatment.

EP023 / #912

Topic: AS01. Antimicrobials / AS01.c. Pharmacology

CLINICAL EFFICACY AND SAFETY OF CEFTAROLINE IN A PEDIATRIC POPULATION 0-24 MONTHS OF AGE: DATA FROM THE PUERI STUDY.

E-Posters

E-POSTER VIEWING

Alessandra Romandini¹, Arianna Pani¹, Laura Ilardi², Alice Proto², Elisabetta Stacul³, Chiara Moretti³, Giulia Pattarino³, Stefano Martinelli², Costantino De Giacomo³, Francesco Scaglione^{1,4}
¹Università degli Studi di Milano, Department Of Oncology And Hemato-oncology, Milan, Italy, ²ASST Grande Ospedale Metropolitano Niguarda, Neonatology And Neonatal Intensive Care Unit, Milan, Italy, ³ASST Grande Ospedale Metropolitano Niguarda, Division Of Pediatrics, Milan, Italy, ⁴ASST Grande Ospedale Metropolitano Niguarda, Chemical-clinical Analysis Unit, Laboratory Medicine Department, Milan, Italy

Backgrounds: Ceftaroline is a fifth-generation cephalosporin approved for the treatment of complicated skin and soft tissue infections and community-acquired pneumonia from birth to adulthood in Europe and in the US. Here we present its effectiveness and safety data in a pediatric population.

Methods: This sub-analysis study is conducted on the population included in the PUERI pharmacokinetic and tolerability study: children aged 0-24 months, an underrepresented population in approval trials, enrolled January 2020 to December 2021 at Niguarda Hospital, Milan. The primary endpoints were effectiveness (measured as clinical or microbiological resolution) and safety; secondary endpoints were mortality, rehospitalization within 30 days, length of hospital stay and time to clinical resolution.

Results: The population included infants born at term (n=28) and preterm newborns (n=3) with suspected or confirmed infection. Females were 54,8% of the population, mean age was 8.1 months (± 7). 8 mg/kg/dose was the most used dosage (74.2%), followed by 10 mg/kg/dose (12.9%), 6 mg/kg/dose (9.7%) and 4 mg/kg/dose (3.2%), the latter used only in infants <2 months. In 64% of patients, infection was the cause of hospitalization. Infection was confirmed in 58.1% of cases: among positive cultures, 55.5% were Staphylococci. 32.2% of isolated bacteria were MDRs (25% of term population, 100% of preterm newborns). Ceftaroline was effective as salvage therapy in 61.3% of cases, while it led to resolution in 83.9% of cases. Rehospitalization occurred in 2 cases (6.4%), of which 1 was for infection. Death occurred in 1 patient (3.2%), affected with Fallot tetralogy and pulmonary valve agenesis. Safety was confirmed, as only 1 adverse event occurred (urticarial rash and vomit on fourth cycle of ceftaroline).

Conclusions/Learning Points: Our data confirmed ceftaroline's effectiveness and safety in patients aged 0-24 months. The study was limited by the numerosity of patients and by its real-world setting.

EP024 / #1873

Topic: AS01. Antimicrobials / AS01.d. Antibiotic Stewardship

DIAGNOSTIC STEWARDSHIP IN PEDIATRIC SETTING: A SYSTEMATIC REVIEW AND META-ANALYSIS OF POINT-OF-CARE TESTS FOR INFECTIOUS ASSESSMENT

E-Posters

E-POSTER VIEWING

Giulia Brigadoi¹, Andrea Gastaldi², Marco Moi¹, Elisa Barbieri³, Sara Rossin⁴, Annalisa Biffi⁵, Anna Cantarutti⁵, Carlo Giaquinto³, Liviana Da Dalt⁴, Daniele Donà³

¹University of Padua, Department For Woman And Child Health, Padua, Italy, ²University of Verona, Woman's And Child's Hospital, Verona, Italy, ³University of Padua, Division Of Paediatric Infectious Diseases - Department For Woman's And Children's Health, Padua, Italy, ⁴University of Padua, Pediatric Emergency Department, Department For Woman And Child Health, Padua, Italy, ⁵University of Milano-Bicocca, Department Of Statistics And Quantitative Methods, Division Of Biostatistics, Epidemiology And Public Health, Milan, Italy

Backgrounds: Fever is one of the most common causes of medical evaluation of children, and early discrimination between viral and bacterial infection is essential to reduce inappropriate prescriptions. This study aims to systematically review the effects of Point-of-care tests (POCTs) in changing antibiotic and oseltamivir prescription rate, length of stay, duration of therapy and healthcare costs.

Methods:: Embase, MEDLINE and Cochrane Library databases were systematically searched, with restrictions from January 1st, 2000, to June 30th, 2021. All randomized control trials and non-randomized observational studies meeting inclusion criteria were evaluated using the NIH-assessment tool. A meta-analysis was also performed to assess the effects of rapid influenza diagnostic tests and film-array respiratory panel implementation on selected outcomes.

Results: A total of 6440 studies were screened, of which 87 were eligible for the review. The analysis was stratified by setting (ED, inpatient, outpatient) and type of POCT. The most frequent POCTs implemented were those for respiratory pathogens, as Rapid Influenza Diagnostic Test (RIDT, 25.3%) and film-array (FA-RP, 25.3%). Separate meta-analyses for 21 RIDT and 15 FA-RP studies assessed a significant reduction in antibiotic prescription in both cases, especially for positive vs negative results or when compared to standard tests (Figure 1). Oseltamivir prescription is also significantly improved by use of RIDT. Even without meta-analysis plotting, days of therapy, length of stay and healthcare costs show an overall trend in reduction when POCTs are used.

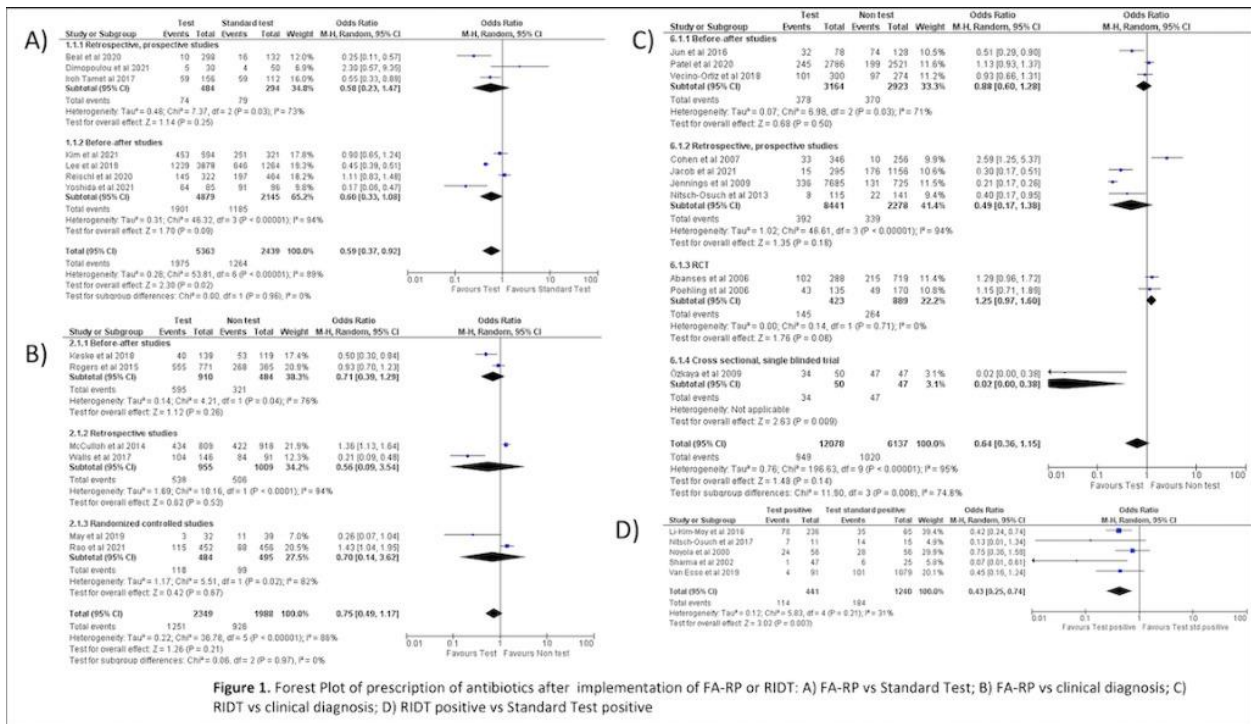

Figure 1. Forest Plot of prescription of antibiotics after implementation of FA-RP or RIDT: A) FA-RP vs Standard Test; B) FA-RP vs clinical diagnosis; C) RIDT vs clinical diagnosis; D) RIDT positive vs Standard Test positive

Conclusions/Learning Points: The implementation of POCTs seems to be a valuable tool to improve appropriate antimicrobial prescriptions. Indeed, POCTs should be constantly combined within well-structured antimicrobial stewardship programs, as recommended by international societies for infection prevention and control.

EP025 / #1051

Topic: AS01. Antimicrobials / AS01.d. Antibiotic Stewardship

EVALUATION OF SURGICAL ANTIBIOTIC PROPHYLAXIS USING A TIME OUT STRATEGY AT TERTIARY LEVEL PEDIATRIC HOSPITAL IN MEXICO CITY.

E-Posters

E-POSTER VIEWING

María De Los Ángeles Costta Michuy, Eduardo Arias De La Garza, Luisa Diaz
Instituto Nacional de Pediatría, Pediatric Infectious Diseases, CDMX, Mexico

Backgrounds: There is certainty that surgical antibiotic prophylaxis is useful in the prevention of surgical site infection. The prescription of antimicrobials can be perceived as a secondary task and one that is even delegated to young surgical members. The objective of this study was to describe the most frequent errors in surgical prophylaxis prescription.

Methods: This is an analytic transverse study in a six-month period (November 2020-March2021), that includes antibiotic prescriptions on surgical departments. For variable analysis, a Chi-square test, odds ratio and etiological fraction among exposed will be performed.

Results: 423 antibiotic prescriptions were analyzed, 210 achieved inclusion criteria and 190 were indicated as surgical antibiotic prophylaxis, 118 of these have at least one error in prescription. The odds ratio for prescription errors and the indication of antibiotics as prophylaxis (Pearson chi square test 16.442 p 0.00) were 9.29 (CI 95% 2.63-32.8), etiological fraction among exposed were 89.23%. Table 1 shows surgical antibiotic prescriptions for services in descending order, although the patients were from surgery services, the prescriptions were not always made from the same service (for example anesthesiology) and the number error prescriptions to show which areas should be trained in prescribing antibiotics. The most frequent errors in the initial prescription of antibiotics that were documented corresponded to not indicating the time of administration of the antibiotic in the case of surgical prophylaxis and dosage. After applying the "Time out" strategy, the most documented error was the prolongation of antibiotic prophylaxis.

Table 1. Surgical antibiotic prescriptions

| Service | Prescriptions | Prescriptions with at least one error |
|------------------|------------------|---------------------------------------|
| Anesthesiology | 53 (27.9) | 53/53 |
| Orthopedics | 46 (24.2) | 34/46 |
| General surgery | 34 (17.9) | 16/34 |
| Urology | 18 (9.5) | 5/18 |
| Neurosurgery | 17 (8.9) | 4/17 |
| Oncology surgery | 17 (8.9) | 2/17 |
| Plastic surgery | 5 (2.7) | 4/5 |
| Total | 190 (100) | 118/190 (62.1%) |

Source: work group. 2021

Conclusions/Learning Points: Antimicrobial education is needed to correct the high percentage of errors observed in prescriptions. Knowing this baseline state is the initial step for the formulation of antimicrobial use optimization programs that reduce adverse events, costs, and local antimicrobial resistance rates.

EP027 / #728

Topic: AS01. Antimicrobials / AS01.d. Antibiotic Stewardship

USE OF NITAZOXANIDE IN A TERTIARY PAEDIATRIC HOSPITAL

E-Posters

E-POSTER VIEWING

Carlos Grasa¹, Nuria Blázquez², Marta Alcón Grases³, Laura Montes⁴, Francisco Moreno², Fernando Baquero-Artigao¹, Cristina Jiménez Núñez², Paula Rodríguez Molino⁴, Ana Méndez-Echevarría¹, Teresa Del Rosal¹, Talia Sainz⁴, Luis Alonso⁴, Milagros García-López Hortelano⁵, Clara Udaondo⁶, Javier Aracil⁴, Cristina Ots⁴, María Jose Mellado¹, Cristina Calvo¹

¹Hospital Universitario La Paz, Paediatric Infectious Diseases Unit, Department Of Paediatrics, Madrid, Spain, ²Hospital Universitario la Paz, Pharmacy, Madrid, Spain, ³Hospital Universitario Miguel Servet, Paediatrics, Zaragoza, Spain, ⁴La Paz University Hospital, Pediatrics And Infectious Diseases, Madrid, Spain, ⁵Hospital La Paz, Pediatric Infectious Diseases, Madrid, Spain, ⁶Hospital Universitario la Paz, Paediatrics, Madrid, Spain

Backgrounds: Nitazoxanide is approved for use in children as antiprotozoal drug (Cryptosporidium, Giardia and Hymenolepis), and also against Influenza. Despite these limited indications, the role of nitazoxanide treating viral gastrointestinal infections has been suggested. The aim of this study is to describe the use of nitazoxanide in the paediatric population.

Methods: Retrospective analysis of all regimens of nitazoxanide prescribed in a paediatric tertiary hospital, focused on indication, characteristics of patients, efficacy and side effects, over a period of 12 years (2009-2021).

Results: A total of 34 nitazoxanide courses were recorded in 31 patients, with a median age of 76 months (IQR 22-120 months) and male predominance 80%; 22 cases(65%) within the last 2 years. Most of them were immunocompromised (88.5%): 22 solid organ transplants, 6 haematological stem-cell transplants, 2 had gastrointestinal condition, 1 had primary immunodeficiency and 1 HIV-infection. Most common symptom was diarrhoea in 32 cases (94%) and consult with paediatric infectious diseases team was recorded in 23 cases (67.6%). In all cases microbiological detection (Figure 1) was performed within 7 days prior to start therapy, and in 12 cases other drugs were used before nitazoxanide. Median duration of therapy was 14 days (IQR 10-16.75days), with a median dosing of 20 mg/Kg/day,q12h. There was improvement in symptoms in 70% cases, with complete resolution of diarrhoea in 40.6% (13/32), although a negative microbiological test after therapy was only proved in 32% (8/25). Only 3 patients had mild side-effects.

Microbiological detection

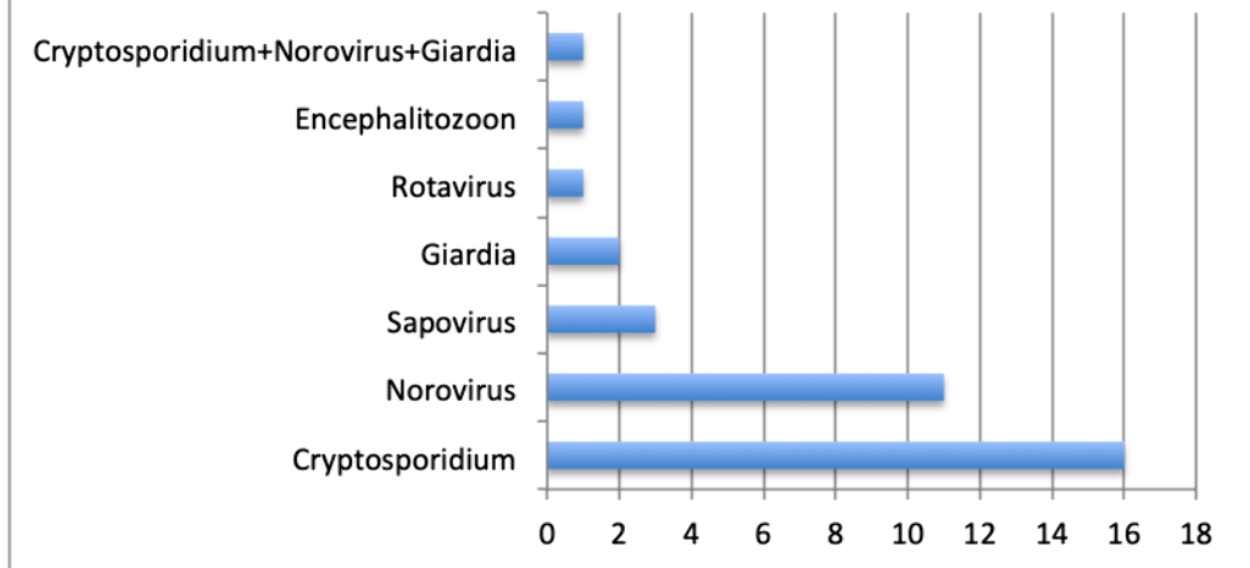

Conclusions/Learning Points: Off-label prescription of nitazoxanide is growing. In selected patients potential benefits with clinical improvement may overcome side effects, despite microbiological eradication was limited. Rationale use of nitazoxanide should be encouraged considering doubtful benefit for some indications and limited availability.

EP028 / #747

Topic: AS01. Antimicrobials / AS01.d. Antibiotic Stewardship

SCREENSHOT OF GLOBAL ANTIBIOTIC USE IN TERTIARY PAEDIATRIC HOSPITAL

E-Posters

E-POSTER VIEWING

Carlos Grasa¹, Laura Montes², Marta Alcón Grases³, Laura Sanchez García⁴, Isabel San Juan⁵, Cristina Schüffelmann⁶, Luis Escosa-García¹, Lucía Hernández Rivas⁵, Teresa Pedraz González-Tablas⁵, Mercedes Castro Martínez⁵, Vanessa Pachón Olmos⁵, Enrique Sanz Olea⁵, Claudia García Vaz⁵, Francisco Moreno⁷, Paula Rodriguez Molino², Ana Méndez-Echevarría¹, Sara Gallego⁵, Teresa Del Rosal⁸, Talia Sainz², Clara Udaondo⁹, Luis Alonso², Milagros García-López Hortelano⁸, Cristina Ots², Javier Aracil², Maria Jose Mellado¹, Ana Robustillo⁵, Adelina Pellicer⁴, Cristina Calvo¹, Paloma Dorao⁶, Fernando Baquero-Artigao¹

¹Hospital Universitario La Paz, Paediatric Infectious Diseases Unit, Department Of Paediatrics, Madrid, Spain, ²La Paz University Hospital, Pediatrics And Infectious Diseases, Madrid, Spain, ³Hospital Miguel Servet, Paediatrics, Zaragoza, Spain, ⁴Hospital La Paz, Neonatology, Madrid, Spain, ⁵Hospital Universitario la Paz, Preventive Medicine, Madrid, Spain, ⁶Hospital Universitario la Paz, Paediatric Intensive Care Unit, Madrid, Spain, ⁷Hospital Universitario la Paz, Pharmacy, Madrid, Spain, ⁸Hospital La Paz, Pediatric Infectious Diseases, Madrid, Spain, ⁹Hospital Universitario la Paz, Paediatrics, Madrid, Spain

Backgrounds: Antimicrobial agents are the most prescribed drugs in paediatrics: mainly for treatment but also as prophylaxis, implying high direct costs for pharmacy and indirect costs in terms of side-effects and antimicrobial resistance. The aim of this study is to describe the use of antimicrobials in children admitted to our centre.

Methods: Transversal analysis of all antimicrobials, excluding antivirals, administered to children admitted in a paediatric tertiary hospital, evaluating prescription at 8 am in a working day in November 2021. Name of antimicrobials and indication were recorded; appropriateness of prescription was evaluated by a physician who was not responsible of each patient.

Results: 100 patients received antimicrobials at the day of evaluation (51% of admitted patients). Median age was 4 years (IQR 7 months-12.7 years), male 55%. 13 patients were colonized by multidrug resistant bacteria (5 VIM-producing metalloβ-lactamase) and 43 patients were immunocompromised. In 14 cases paediatric infectious diseases (PID) team was contacted. 49 patients received empirical antimicrobials, in 29 antimicrobial was targeted and 49 patients received prophylactic antimicrobials (some patients had several indications). See antibiotics used in Figure 1: most prescribed antibiotics were co-trimoxazole in 20 patients (20%) and meropenem in 17 patients; 19% received antifungals. Global evaluation of antimicrobials showed that indication was correct in 69 cases (69%), doubtful in 7 cases, and incorrect in 24 cases, being the main incorrect reasons: wrong antibiotic in 14 cases, too broad spectrum in 9 cases, and excessive duration in 5 cases.

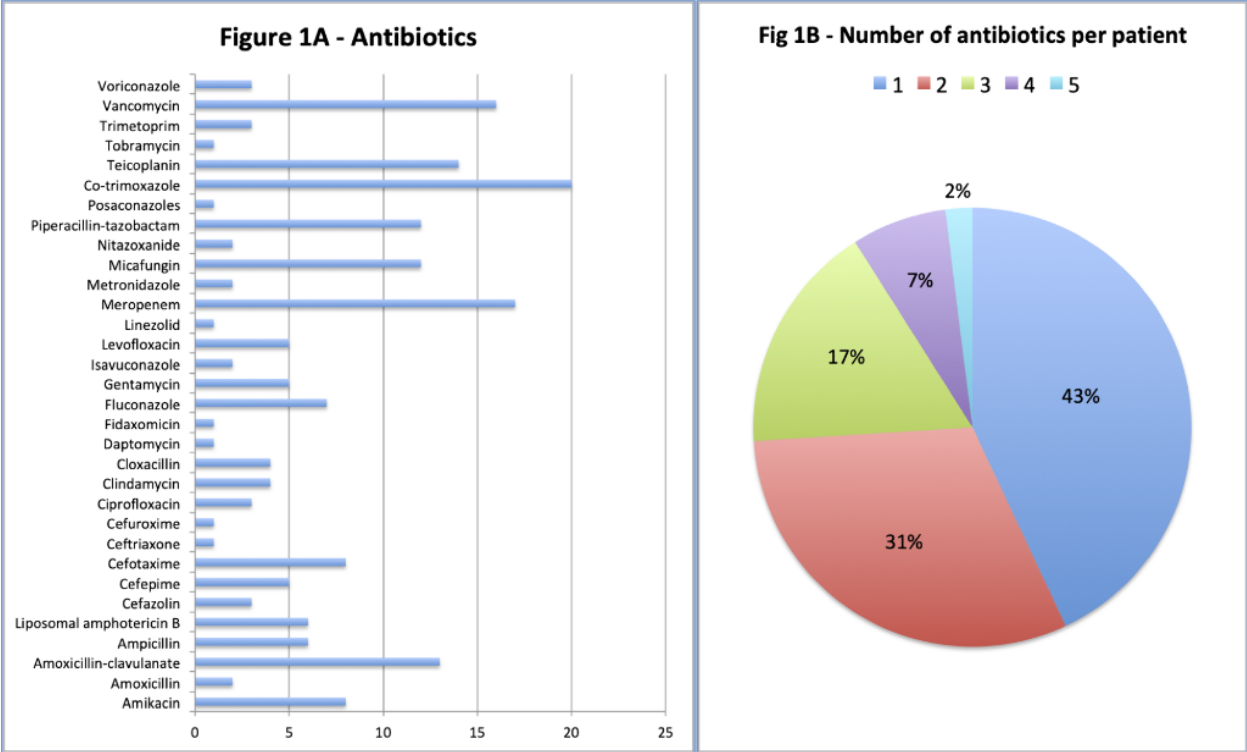

Conclusions/Learning Points: A high proportion of patients received antibiotic as prophylaxis, broad-spectrum antibiotics, and antifungals. PID team was consulted in few cases, and prescription could have been improved in a substantial number of patients.

EP029 / #642

Topic: AS01. Antimicrobials / AS01.d. Antibiotic Stewardship

ANTIBIOTIC PRESCRIPTION RATES AMONG CHILDREN FELL TO AN ALL-TIME LOW DURING THE COVID-19 PANDEMIC – RESULTS FROM NATIONWIDE REAL-LIFE MONITORING OF ANTIBIOTIC USE IN GERMANY

E-Posters

E-POSTER VIEWING

Jakob Holstiege, Manas Akmatov, Maike Schulz, Claudia Kohring, Lotte Dammertz, Joachim Heuer, Jörg Bätzing

Central Research Institute of Ambulatory Health Care in Germany (Zi), Epidemiology And Health Care Atlas, Berlin, Germany

Backgrounds: European surveillance data showed a reduction of antibiotic use in the general population between 2019 and 2020 by more than 15%. The current study provides results from ongoing real-life monitoring of outpatient antibiotic use among children during the COVID-19 pandemic in Germany.

Methods: We analysed nationwide outpatient prescription claims of the Statutory Health Insurance (SHI) from January 2019 to October 2021. All SHI-children aged 0-14 years (n=9,688,483 at July 1, 2021) were included, covering about 83% of the total paediatric population in Germany. Monthly antibiotic prescription rates per 1,000 children before (2010-2019) and during the pandemic (2020-2021) were examined. Interrupted time series analysis was applied to examine the effect of mitigation measures in Germany (April 2020 and January 2021) on antibiotic prescription rates.

Results: Prescription rates showed an expected seasonal pattern of high antibiotic use between January and March 2020 (34-41/1,000 children), but declined steeply following closures of day care centers and schools in April to 9 prescriptions per 1,000 children ($p < 0.0001$). The rates remained low until August 2021 at an average of 11 prescriptions per 1,000 children. Overall, the annual paediatric prescription rate declined by 43% from 2019 to 2020. The pooled prescription rate between January and October 2021 was 58% lower than the corresponding rate in 2019.

Conclusions/Learning Points: This study provides a continuously updated national picture of paediatric antibiotic use during the COVID-19 pandemic. Substantial reductions in prescription rates may indicate limited access to medical care and changes in care seeking behaviour. However, as national inpatient surveillance of serious respiratory infections among children showed no typical seasonal increase in winter 2020/2021, reduced antibiotic use likely reflects a reduction in the incidence of infections resulting from risk-mitigation measures.

EP030 / #441

Topic: AS01. Antimicrobials / AS01.d. Antibiotic Stewardship

INFECTION BIOMARKERS THAT MODULATED EMPIRIC ANTIMICROBIAL TREATMENT (EAT) PRESCRIBING IN CHILDREN AGED 0-3 YEARS HOSPITALIZED FOR SARS-COV-2 INFECTION IN BUCHAREST ROMANIA – 2021

E-Posters

E-POSTER VIEWING

Niculae Ion Nedelcu¹, Petre Iacob Calistru²

¹Spital boli infectioase si tropicale, Infection Control, Bucharest, Romania, ²Spital General - Fundatia "Dr Victor Babes", Management, Bucharest, Romania

Backgrounds: As community pneumonia is common in Covid 19 patients who require hospitalization prescribing antimicrobial treatment empirically is especially chalang Objective: in this study we tried to evaluate the predictability of the usual markers of infection in the decision to drive EAT in children 0-3 yearseing in the case of vulnerable patients such as very young children

Methods: – study cohort included the Covid 19 patients (ICD-10: U04.7) aged 0-3 years, consecutively admitted in the first 10 months of 2021 in our 490 bed clinic. EAT was defined as presence in the patient medical chart of at least one dose of systemic antimicrobial presribed in the 48 hous since admission. Elevated values of serum C reactive protein (CRP) or procalcitonin (PCT) found at hospital admision were considered as modulators of EAT prescribing.

Results: Results – in the study were included 106 children aged 0-3 years (IQR: 0-2 years) without laboratory evidence of bacterial coinfection. Their relevant data was retrieved from the electronic register of the clinic and processed with Epi Info 7 software. The prevalence of children who received EAT was: 64.2 % (95%CI: 54.3 % - 73.2 %). The positive predictive value of CRP was 96.9% and the specificity was 67.6% The predictive value of PCT was 79.4% and the specificity was 87.1%.

Conclusions/Learning Points: Lesson learned – in EAT prescribing appears that clinicians behaviour is modulated by infection biomarkers – they being comfortable in prescribing EAT in case of elevated CRP but being reluctant in case of non elevated procalcitonin.

EP031 / #501

Topic: AS01. Antimicrobials / AS01.d. Antibiotic Stewardship

FREQUENCY AND NATURE OF EMPIRICAL ANTIMICROBIAL TREATMENT PRESCRIBED TO HOSPITALIZED PEDIATRIC PATIENTS FOR SARS-COV-2 (COVID-19) IN A CLINIC IN BUCHAREST, ROMANIA 2021

E-Posters

E-POSTER VIEWING

Niculae Ion Nedelcu¹, Simin-Aysel Florescu²

¹Spital boli infectioase si tropicale, Infection Control, Bucharest, Romania, ²Institute od Medicine and Pharmacy "Carol Davila" Bucharest, Infection Diseases, Bucharest, Romania

Backgrounds: Currently reported data shows that EAT (empirical antimicrobial treatment) continues to be prescribed to patients with Covid-19 even in the absence of a microbiologically confirmed infection. However, data on how widespread this practice is in children are scarce. Our goal was to highlight the prevalence and nature of EAT prescribed in Covid-19 pediatric patients

Methods: Study conducted in a cohort of patients hospitalized between January 1 and October 31 for SARS-CiV-2 virus infection in our 490-bed clinic in Bucharest. Relevant data from patients in the 0-19 age group were extracted from the hospital's electronic register and listed in an MS Excel spreadsheet. An EAT prescription was assimilated with the presence in the patient's medical chart of at least one dose of systemic antimicrobial prescribed within the first 48 hours of hospital admission. If the prescription contained a broad-spectrum antimicrobial (e.g., cephalosporins or carbapenems), then this was classified as an empirical broad-spectrum antimicrobial treatment (EBAT).

Results: The study included 191 patients without microbiological evidences of bacterial infection in the first 48 hour since hospitalization. The mean age (SD) of the patients was 5.26 (6.05) years and IQR: 0-11. The prevalence of patients with EAT was 68.1 % (95%CI: 60.9 % - 74.6 %). The prevalence of patients with EBAT was 45.4 % (36.6 % - 54.3%).

Conclusions/Learning Points: Appears that antimicrobial stewardship interventions as prospective audit and feedback, on one hand and prior authorization for broad-spectrum antimicrobials, on the other hand might be the evidence-based actions to fight against antimicrobials resistance.

EP032 / #1398

Topic: AS01. Antimicrobials / AS01.d. Antibiotic Stewardship

DISPENSING OF ANTIBIOTICS WITHOUT PRESCRIPTION IN GREECE, 2021. CAN NEW LEGISLATION ALTER OLD HABITS?

E-Posters

E-POSTER VIEWING

Lydia Kokkinidou, Dioni Pinelopi Petsiou, Eleni Kourkouni, Christos Triantafyllou, Grammatiki-Christina Tsopela, Theoklis Zaoutis, [Ioannis Kopsidas](#)
Center for Clinical Epidemiology and Outcomes Research, Cleo, Athens, Greece

Backgrounds: Antibiotic resistance is a crucial and emerging public health problem worldwide. Self-medication, a common practice for years in Greece, is an important driver of antimicrobial agents' overuse and leads to an exacerbation of the problem. Recent legislature that forbids dispensing without a prescription aimed to address this problem. We sought to assess the extent of antibiotic dispensing in the community without medical prescription and compare to a prior 2008 study by Plachouras et al to assess the effectiveness of new legislation.

Methods: In this prospective observational study (December 2021-January 2022), antibiotics were requested without prescription from 110 community pharmacies proportionally assigned to the 5 regions of Athens, according to their population. Volunteers randomly selected which pharmacies to visit in each region and asked either for a box of ciprofloxacin 500mg or amoxicillin/clavunate 1gr (6:5 ratio). Ciprofloxacin requires an additional special prescription. Data on acquisition or dispensing refusal were collected, analyzed, and are presented as frequencies. Our results were compared to a prior 2008 study.

Results: All (100%) of pharmacists refused to dispense ciprofloxacin. Only One of the pharmacies we visited dispensed amoxicillin/clavulanate. Comparing to an equivalent study performed in 2008, dispensing of amoxicillin/clavulanate from 100% in 2008 to 1% and ciprofloxacin from 53% in 2008 to 0%. Dispensing by region and by agent in 2008 and 2021 is shown in Table

1.

Table 1 - Dispensing of antibiotics without prescription in pharmacies by region and agent in Athens, Greece in December 2021 - January 2022 and comparison with April-May 2008

| | Population | | Number of pharmacies visited (n) | Number of pharmacies dispensing ciprofloxacin (n, %) | Number of pharmacies dispensing Amox/Clav (n, %) | % Of pharmacies dispensing ciprofloxacin | % Of pharmacies dispensing Amox/Clav |
|------------------|------------|--------|----------------------------------|--|--|--|--------------------------------------|
| | n | % | | | | | |
| City Center | 1,029,520 | 32.7% | 36 | 0 | 0 | 46% | 100% |
| Northern suburbs | 592,490 | 18.8% | 21 | 0 | 0 | 50% | 100% |
| Western Suburbs | 489,675 | 15.6% | 17 | 0 | 1(12.5%) | 54% | 100% |
| Southern suburbs | 529,826 | 16.9% | 18 | 0 | 0 | 61% | 100% |
| Eastern Suburbs | 502,348 | 16.0% | 18 | 0 | 0 | Not visited | Not visited |
| Total | 3,143,859 | 100.0% | 110 | 0 (0%) | 1 (1%) | 53% | 100% |

* Plachouras, D., et al. "Dispensing of antibiotics without prescription in Greece, 2008: another link in the antibiotic resistance chain." *Eurosurveillance* 15.7 (2010): 19488.

Amox/Clav – Amoxicillin/Clavunate

Conclusions/Learning Points: Overall, it is evident that antibiotic dispensing without prescription has been dramatically reduced, as a result of new legislation being implemented in Greece. Similar initiatives could aid to battle Greece's problem of antibiotic consumption and resistance.

EP033 / #1064

Topic: AS01. Antimicrobials / AS01.d. Antibiotic Stewardship

PATTERNS AND TRENDS OF ANTIMICROBIAL USE IN A PEDIATRIC INTENSIVE CARE UNIT (PICU) USING DAYS OF THERAPY

E-Posters

E-POSTER VIEWING

Areti Nikolaidou¹, Kyriaki Moustakidou Papadaki¹, Maria Kourti¹, Elisavet Chorafa¹, Elias Iosifidis¹, Maria Sdougka², Emmanuel Roilides¹

¹Aristotle University of Thessaloniki, Infectious Diseases Unit, 3rd Pediatric Department, Thessaloniki, Greece, ²Hippokration Hospital of Thessaloniki, Pediatric Intensive Care Unit, Thessaloniki, Greece

Backgrounds: Monitoring of antimicrobial use is essential for antimicrobial stewardship programs. We studied pattern and time trends of antimicrobial use in PICU.

Methods: A retrospective analysis of monthly antimicrobial use at a patient-level was conducted in an 8-bed polyvalent PICU of a tertiary-level hospital from June 2018 to December 2019. Days of Therapy (DOT) of each antimicrobial agent/category divided by 100 bed-days (DOT/100BD) was used.

Results: During study period there were 178 admissions and a median monthly rate (MR) of 181 bed-days. Total consumption of antimicrobials had a median monthly rate (MMR) 259 DOTs/100BD. Glycopeptides (vancomycin/teicoplanin) constituted the most common used antimicrobial class (40 DOT/100BD) but showed a significant decrease during the last 4 months of the study. Cephalosporins were the second most used antimicrobial class (32 DOT/100BD) with 3rd generation cephalosporins (GC) being the most prevalent (26 DOT/100BD). Use of 2nd GC and 4th GC was low (1 and 2DOT/100BD, respectively). Consumption of both ceftazidime/avibactam and ceftolozane/tazobactam was documented only for 2 months during the study period (MMR 7 and 9 DOT/100BD, respectively). Utilization of aminoglycosides had a MMR 29 DOT/100BD. Carbapenems (mainly meropenem), colistin and piperacillin/tazobactam (the most used penicillin) had a MMR 27, 18 and 12 DOT/100BD, respectively. Metronidazole and clindamycin had a MMR 23 DOT/100BD and 9 DOT/100BD, respectively. Use of other antimicrobials included macrolides, ciprofloxacin and co-trimoxazole with a MMR of 14, 14 and 3 DOT/100BD, respectively. Linezolid use was infrequent whereas tigecycline was used at a MMR of 3.7 DOT/100BD.

Conclusions/Learning Points: High prevalence of antimicrobials use, relatively high utilization of colistin and constant use of tigecycline is of concern and may reflect emergence of multidrug resistant bacteria.

EP034 / #644

Topic: AS01. Antimicrobials / AS01.d. Antibiotic Stewardship

COMPARING THE EFFECTS OF FACILITY-SPECIFIC GUIDELINES AND NUDGE-BASED ANTIMICROBIAL STEWARDSHIP AT PEDIATRIC PRIMARY EMERGENCY MEDICAL CENTERS IN JAPAN

E-Posters

E-POSTER VIEWING

Shogo Otake¹, Yoshiki Kusama², Shinya Tsuzuki³, Masashi Kasai¹

¹Kobe Children's Hospital, Pediatrics, Hyogo, Japan, ²Hyogo Prefectural Amagasaki General Medical Center, Pediatrics, Hyogo, Japan, ³National Center for Global Health and Medicine Hospital, Amr Clinical Reference Center, Disease Control And Prevention Center, Tokyo, Japan

Backgrounds: Antimicrobial prescription rates tend to be high in outpatient settings. Primary emergency medical centers (PECs) in Japan encounter difficulties in implementing antimicrobial stewardship programs (ASPs). While we have demonstrated the positive effect of a nudge-based ASP for oral third-generation cephalosporins (3GCs), this strategy requires considerable effort to publish monthly newsletters. Therefore, developing more preferable ASP models in PECs is essential.

Methods: We conducted a multi-center, quasi-experimental study. The Himeji Primary Emergency Medical Center for Nights and Holidays (Site A) introduced the facility-specific guideline referring to national guidelines. The Kobe Children's Primary Emergency Medical Center (Site B) provided the results of the monitoring for antibiotics prescription as a monthly newsletter. The Hanshin-Kita Children's First-Aid Center (Site C) did not perform the specific ASP. Prescription rates for 3GCs were categorized into pre-and post-intervention and compared using Poisson regression analysis. The difference-in-differences method was used to assess the effect of these interventions.

Results: The numbers of patients pre- and post- intervention were 177,126 and 91,251, respectively. The 3GCs prescription rate at Site A, Site B, and Site C decreased from 6.7%, 4.2%, and 6.1% in 2016 to 2.3%, 1.0%, and 2.0% in 2019, respectively. Site B had a greater reduction than Site A and Site C (odds ratio [OR] 0.81 [95% confidence interval (CI) 0.70–0.93]; $P < 0.001$, OR 0.76, [95%CI 0.66–0.87]; $P = 0.004$). There was no significant difference between Site A and Site C (OR 0.94 [95%CI 0.83–1.06]; $P = 0.33$).

Conclusions/Learning Points: Facility-specific guideline was less effective than nudge-based ASP for decreasing oral 3GCs prescription in PECs.

EP035 / #335

Topic: AS01. Antimicrobials / AS01.d. Antibiotic Stewardship

POINT PREVALENCE SURVEY TO ESTIMATE ANTIMICROBIAL USE IN A TERTIARY CARE UNIVERSITY HOSPITAL IN PAKISTAN

E-Posters

E-POSTER VIEWING

Muhammad Sharif

King Edward Medical University/Mayo Hospital Lahore, Pediatric Surgery Kemu/mayo Hospital Lahore Pakistan, LAHORE, Pakistan

Backgrounds: The main cause of antimicrobial resistance is over use of antibiotics which can be reduced if we limit use of antibiotics. Understanding the indications, dose used and adherence to guidelines are main factors to reduce antimicrobial consumption and resistance. Rationale of this study was to conduct a point prevalence survey in different wards to look into pattern of antibiotic used and estimate the antimicrobial usage (AMU) in a tertiary care university hospital so that the proper use of antimicrobial drugs can be implemented in our hospital .

Methods: After taking Ethical approval, We conducted a consecutive 10 days cross-sectional survey from 19th October to 29th October 2020 from patient's files. The data regarding patient demography i.e., age, sex, admission detail, documentation of antimicrobials including antibiotic type, dose, indications, route of administration, duration, their empirical / targeted use ,stop / review order of antimicrobial after 48 hours, was collected on online survey form using KOBACOLLECT software

Results: Total of 671 patients files were reviewed. 60.06% were males and 39.9% were females. 89.97% were on antibiotics .Out of 1054 antibiotics being used ceftriaxone was most commonly used antibiotics (47.91%) followed by metronidazole, amikacin, amoxicillin/clavulanic acid, Moxifloxacin, Tazobactam plus piperacillin and meropenem etc. Surgical prophylaxis most common indication (39.67%) followed by medical prophylaxis (27.84%) community acquired infections (23.29%), and hospital acquired infections (4.45%) etc.

Conclusions/Learning Points: We observed high use of antibiotics both for prophylactic and therapeutic purposes for hospital acquired infections and in majority of cases antibiotics were used empirically without any written documentation of stop or review orders or local antibiotic Policy. So, there is need to develop local and national stewardship program to rationalize and reduce the use of antibiotics for prevention of antimicrobial resistance

EP036 / #928

Topic: AS01. Antimicrobials / AS01.d. Antibiotic Stewardship

ANTIMICROBIAL STEWARDSHIP AWARENESS AND PRACTICES AMONG A TARGET AUDIENCE OF AN INTERNATIONAL E-LEARNING PLATFORM ON PEDIATRIC INFECTIOUS DISEASES: A PILOT SURVEY

E-Posters

E-POSTER VIEWING

Daniilo Buonsenso¹, [Olha Shvaratska](#)², Anna Hermine Markowich³, Sofia Benou⁴, Kevin Meesters⁵, Joycelyn Dame⁶, Tinsae Alemayehu⁷

¹Fondazione Policlinico Universitario A. Gemelli IRCCS, Pediatrics, Roma, Italy, ²Dnipro State Medical University, Department Of Pediatrics 3 And Neonatology, Dnipro, Ukraine, ³Bambino Gesù Children's Hospital, Paediatric Department, Rome, Italy, ⁴General University Hospital of Patras, University of Patras, Department Of Paediatrics, Patras, Greece, ⁵BC Children's Hospital/University of British Columbia, Department Of Pediatrics Infectious Diseases, Vancouver, Canada, ⁶University of Ghana Medical School, Department Of Child Health, Accra, Ghana, ⁷St. Paul's Hospital Millennium Medical College / American Medical Center, Pediatric Infectious Diseases, Addis Ababa, Ethiopia

Backgrounds: Inappropriate antibiotic use has become a global concern in the recent decades. To address this issue, the World Society for Pediatric Infectious Diseases (WSPID) promotes antimicrobial stewardship (AMS) through the online courses on the WSPID Global E-learning Portal launched in September 2021.

Methods: The Young WSPID Online Portal Task Force performed an assessment of AMS awareness and practices of a target audience by running a dedicated electronic anonymous survey.

Results: A total of 19 pediatric infectious diseases specialists from 15 countries responded to the questionnaire. Two thirds of the responders were young professionals, 52.6% were females. All the world regions were represented except for Australia; 21.1% of respondents resided in lower-middle income countries. Most of the responders work in general (36.8%) or pediatric (52.6%) hospital settings. Only half of represented countries possessed an established national pediatric AMS program. The majority of participants disapproved having a pediatric AMS service at work or AMS training during their residency program. As the most essential pediatric AMS interventions, 57.9% of the respondents suggested implementation of organizational measures (AMS teams and electronic prescribing), 52.6% - monitoring of antimicrobial susceptibility and antibiotic use, 42.1% - internal regulatory standards/guidelines, 36.8% - education and 31.6% - infection control interventions. Among the most frequent indications for antibiotic prescription in the respondents' practice, respiratory tract infections and urinary tract infections were listed most frequently (63.2% and 31.6%, respectively). The most prescribed antibiotics were intravenous cephalosporines (31.6%), amoxicillin and amoxicillin/clavulanate (26.3% each).

Conclusions/Learning Points: The survey data have been considered when preparing educational materials for the WSPID Global E-learning Portal. Enrollment to the AMS course has been kept at the level of 10% of all Portal users during a 3-month period after the official Portal launch.

EP037 / #1229

Topic: AS01. Antimicrobials / AS01.d. Antibiotic Stewardship

TOPICAL ANTIBIOTICS FOR ACUTE CONJUNCTIVITIS IN CHILDREN: RANDOMIZED CONTROLLED TRIAL AND META-ANALYSIS

E-Posters

E-POSTER VIEWING

Minna Honkila^{1,2}, Ulla Koskela^{1,2}, Tero Kontiokari³, Marja-Leena Mattila³, Aila Kristo⁴, Raija Valtonen⁵, Suvi Sarlin^{1,2}, Niko Paalanne^{1,2}, Irma Ikäheimo⁶, Tytti Pokka^{1,2}, Matti Uhari^{1,2}, Marjo Renko⁷, Terhi Tapiainen^{1,2}

¹University of Oulu, Pedego Research Unit And Medical Research Centre Oulu, Oulu, Finland, ²Oulu University Hospital, Department Of Paediatrics And Adolescent Medicine, Oulu, Finland, ³Mehiläinen Oulu, Paediatrics, Oulu, Finland, ⁴Mehiläinen Oulu, Otorhinolaryngology, Oulu, Finland, ⁵Terveystalo Oulu, Paediatrics, Oulu, Finland, ⁶NordLab Oulu, Clinical Microbiology, Oulu, Finland, ⁷University of Eastern Finland and Kuopio University Hospital, Department Of Paediatrics, Kuopio, Finland

Backgrounds: Physicians frequently prescribe antibiotics for acute conjunctivitis in children. Yet, the evidence for the benefits of antibiotic therapy is limited and conflicting. The aim of the present study was to investigate the efficacy of topical antibiotics compared with placebo and no treatment in the management of acute conjunctivitis in children.

Methods: We conducted a randomized controlled trial (RCT) where children from 6 months to 7 years of age with acute conjunctivitis were randomly allocated in a 1:1:1 ratio to receive moxifloxacin eye drops (n=30), placebo eye drops (n=27), or no treatment (n=31). The primary outcome measure was the duration (days) of eye symptoms. After the RCT, we performed a meta-analytic review. In the meta-analysis, the main outcome measure was the proportion of participants with a clinical cure on days 3 to 6.

Results: The use of moxifloxacin eye drops significantly reduced the duration of eye symptoms in comparison to no treatment (3.8 vs 5.7 days; P=0.036; 95% CI of the difference -3.72 to -0.10), but not in comparison to the placebo (3.8 vs 4.0 days; P=0.937; 95% CI of the difference -2.15 to 1.61). The meta-analysis of 3 previous and the present study showed that the use of antibiotic eye drops significantly decreased the proportion of symptomatic children on days 3 to 6 compared with the use of placebo eye drops (OR 0.59; 95% CI 0.39 to 0.91; P=0.018).

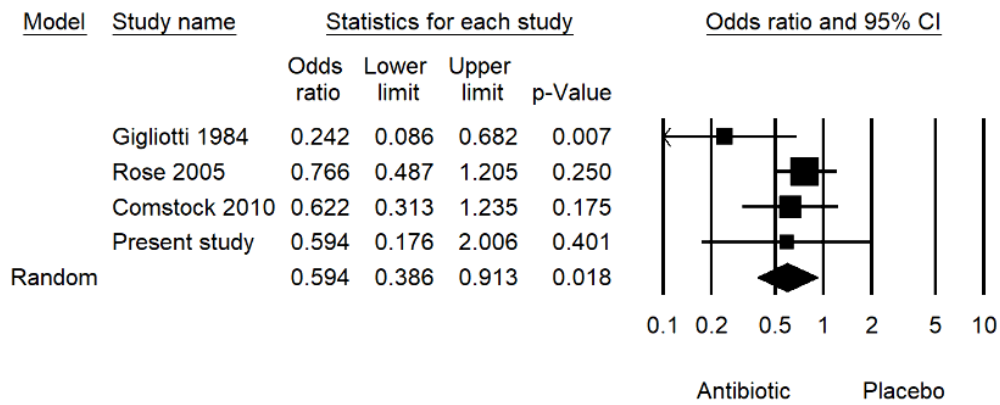

Conclusions/Learning Points: In the RCT, antibiotic eye drops were beneficial in the management of acute conjunctivitis in children compared to no treatment, but the meta-analysis also revealed benefits of antibiotic eye drops in comparison to the placebo.

EP039 / #637

Topic: AS01. Antimicrobials / AS01.d. Antibiotic Stewardship

ANTIBIOTIC SPECTRUM INDEX AS AN ANTIMICROBIAL STEWARDSHIP TOOL IN PAEDIATRIC INTENSIVE CARE SETTINGS

E-Posters

E-POSTER VIEWING

Luca Zombori¹, James Hatcher², Stéphane Paulus³

¹Great Ormond Street Hospital for Children, Paediatric Intensive Care Unit, London, United Kingdom, ²Great Ormond Street Hospital for Children, Department Of Microbiology, London, United Kingdom, ³University of Oxford, Paediatric Infectious Diseases, Oxford, United Kingdom

Backgrounds: Antibiotic resistance has evolved simultaneously with the use of antibiotic therapy. Antimicrobial stewardship (AMS) programs aim to optimise the use of antimicrobial therapy in healthcare and community settings. Antibiotic spectrum index (ASI) is a recently developed antimicrobial stewardship tool which aims to classify antibiotics based on activity against clinically relevant bacterial pathogens.

Methods: We utilised ASI in a 2-year retrospective study in 4 paediatric intensive care units of a tertiary level UK children's hospital to quantify antibiotic use overall and in subgroups based on age; presence of immunosuppression; and presence of AMS input. We compared ASI to days of therapy (DOT) to determine the utility of this AMS metric.

Results: An average of 167 (132-227) patients per month were admitted on the intensive care wards. An average of 61.1% of the patients received antibiotic on any given day. The percentage of patients who received antibiotics shows a decreasing trend over time. However, the spectrum of the antibiotics increases slightly. Patients up to one year of age were treated with the lowest spectrum of antibiotics. Patients who had AMS input had a lower ASixDOT value (range 49.9-107, average 70.6) compared to those who had not (range 68.2-172.9, average 105). Immunocompetent patients received much narrower spectrum antibiotics than immunocompromised patients. The most antibiotics per patient were used in January and July 2020, but the broadest spectrum antibiotics were used in April 2020 and January 2021.

Conclusions/Learning Points: ASI is a promising new AMS tool that can help guide and follow AMS activity on PICUs in the future.

EP040 / #892

Topic: AS02. Public health and epidemiology (only non SARS-CoV2 content) / AS02.a. Population studies and surveillance

EVOLVING MENINGOCOCCAL IMMUNISATION LANDSCAPE, REMAINING GAPS AND CONSIDERATIONS FOR FUTURE LIFELONG IMMUNISATION

E-Posters

E-POSTER VIEWING

Rafik Bekkat-Berkani¹, [Véronique Abitbol](#)², Muhamed-Kheir Taha³

¹GSK Biologicals, Inc., None, Rockville, United States of America, ²GSK Biologicals, Inc., None, Paris, France, ³Université Paris VII Diderot, None, Paris, France

Backgrounds: Effective meningococcal vaccines (MenC, quadrivalent MenACWY, and protein-based MenB vaccines) are available and commonly used in national immunisation programmes (NIPs), with demonstrated reductions in invasive meningococcal disease (IMD) burden over time. However, age-based recommendations create immunisation gaps in specific age-groups. We evaluated the current IMD and immunisation landscape to determine medical need and scope for re-evaluation of existing recommendations in response to evolving epidemiology and environments.

Methods: Targeted review of current IMD literature.

Results: Most meningococcal NIPs target infants, toddlers and adolescents. MenB immunisation is limited to infants in relatively few European countries, and to adolescents/young adults in the United States. Only South Australia and the Czech Republic recommend MenB in both infants and adolescents. Adolescent vaccination is chiefly MenACWY, although often only as a single dose; some countries have no MenACWY recommendations. There are no established adult immunisation recommendations (beyond at-risk individuals) (Figure 1). Targeting younger populations has led over time to shifts of IMD towards older age groups (where morbidity and fatality are generally greater). The current MenACWY vaccination landscape suggests that NIP recommendations could be expanded to include broader toddler and pre-adolescent vaccination. MenB vaccines could be considered for most infant/toddler schedules, while increasing evidence for effectiveness in adolescents (and potential broader protection against other serogroups) supports expansion to children and adolescents. This, along with adult MenACWY and MenB vaccination, is consistent with a lifelong and equitable immunisation approach.

Conclusions/Learning Points: The meningococcal immunisation landscape still fluctuates and gaps do exist. Developing and implementing more inclusive recommendations towards as yet ineligible age-groups should be considered in the near future. The COVID-19 pandemic impact on IMD epidemiology and vaccine uptake must also be considered. **FUNDING:** GlaxoSmithKline Biologicals

SA.

| | Infant (6 weeks to ≤12 months) | Toddler (12–23 months) | Children (2–10 years) | Adolescents & younger adults (11–25 years) | Adults (≥25 years) | At-risk |
|-----------------|--------------------------------------|------------------------------|--------------------------|--|-----------------------|---------------|
| UK | MenB | MenB MenC | | MenACWY | | MenB MenACWY |
| Italy* | MenB | MenB MenC MenACWY* | | MenACWY | | MenB MenACWY |
| France | MenB MenC | MenB MenC | | | | MenB MenACWY |
| Spain* | MenB* MenC | MenB* MenC | | MenACWY | | MenB* MenACWY |
| Germany | MenC | MenC | | | | |
| Portugal | MenB | MenB MenC | | | | |
| Netherlands | | MenACWY | | MenACWY | | |
| Ireland | MenB MenC | MenB MenC | | MenACWY | | MenB MenACWY |
| Belgium* | | MenC MenACWY* | | MenACWY* | | |
| Czech Republic | MenB | MenB MenACWY | | MenACWY MenB | | MenB MenACWY |
| US | | | | MenACWY MenB† | | MenB† MenACWY |
| Canada* | MenC* | MenC* | | MenACWY | | MenB MenACWY |
| Quebec* | | MenC | | MenC | | MenB MenACWY |
| Brazil | MenC | | | MenACWY | | |
| Australia* | | MenACWY | | MenACWY | | MenB MenACWY |
| South Australia | MenB MenACWY | MenB | | MenACWY MenB | | MenB MenACWY |

MenACWY: quadrivalent vaccine against meningococcal A, C, W, and Y serogroups; **MenB:** protein-based vaccine against meningococcal serogroup B; **MenC:** vaccine against meningococcal serogroup C

*Boxes in lighter colour indicate regional/territorial recommendations or for specific ethnic groups
 †Recommended on the basis of shared clinical decision making

UK: United Kingdom
 US: United States of America

Topic: AS02. Public health and epidemiology (only non SARS-CoV2 content) / AS02.a. Population studies and surveillance

DECREASED INCIDENCE OF PNEUMOCOCCAL MENINGITIS IN BRASIL DURING THE COVID19 PANDEMIC

E-Posters

E-POSTER VIEWING

Eitan Berezin¹, Daniel Jarovsky², Sirlene Pereira³, Camila Ribeiro³

¹Santa Casa, Pediatric, SAo Paulo, Brazil, ²Santa Casa de São Paulo, Pediatric Infectious Diseases, São Paulo, Brazil, ³Ministry of Health, Public Health, Brasília, Brazil

Backgrounds: INTRODUCTION - Pneumococcal meningitis (PM) consists of one of the forms of invasive pneumococcal disease (IPD) and is responsible for a significant number of deaths and long-term sequelae. There are emerging reports of significant reductions in IPD and viral infections because of social-distancing measures in countries that implemented lockdown during the COVID-19 pandemic, but data from Brazil is lacking.

Methods: We have performed a descriptive study of confirmed PM cases in Brazil with the onset of symptoms from January 1, 2007, to December 31, 2020. Data were retrieved from the records in the Notifiable Diseases Information System (SINAN).

Results: Between 2007 and 2020, a total of 14,139 episodes of laboratory-confirmed pneumococcal meningitis were described, of which 4,117 (30%) died. After the introduction of PCV10 in infants in 2010, the overall PM incidence coefficient was reduced from 0.58 case/100000 inhabitants during the period before PCV10 (2007-2010) to 0.41 case/100000 inhabitants during the following four years (2017-2020). Likewise, the mean mortality rate was 0.19 deaths/100,000 inhabitants and 0.12 deaths/100,000 inhabitants, respectively. In addition, the PM incidence coefficient in children under five years of age decreased from 2.5 cases/100000 inhabitants in 2007 to 1.0 case/100000 inhabitants in 2015, remained stable from 2016 through 2019 (1.1 case/100000 inhabitants), and then sharply declined to 0.3 cases/100000 inhabitants in 2020.

Conclusions/Learning Points:

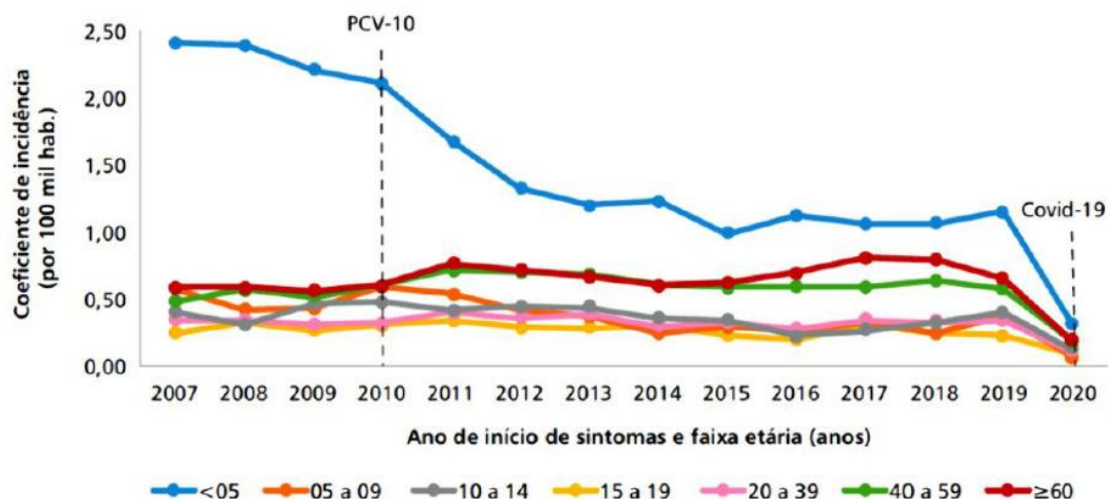

PCV10 resulted in a sustained reduction in pneumococcal meningitis, but the COVID-19 pandemic and

subsequent non-pharmaceutical measures were associated with a more significant decline in PM cases in Brazil.

EP042 / #1443

Topic: AS02. Public health and epidemiology (only non SARS-CoV2 content) / AS02.a. Population studies and surveillance

CLINICAL AND EPIDEMIOLOGIC CHARACTERISTICS OF A COHORT OF HIV-INFECTED MOTHER-INFANT PAIRS DURING 21 YEARS

E-Posters

E-POSTER VIEWING

Marta Illán Ramos¹, Arantxa Berzosa¹, Alba Ruedas², Ignacio Callejas³, Diana Mazarriegos¹, Luis Prieto⁴, Sara Guillén⁵, Maria Luisa Navarro⁶, Luis Escosa-García⁷, Miguel Ángel Roa⁸, José Beceiro⁹, Iciar Olabarrieta¹⁰, Eloy Muñoz¹¹, M^a Carmen Viñuela¹², Francisco Javier Regidor¹³, Manuel Fuentes¹⁴, Jose Tomas Ramos Amador¹⁵

¹Hospital Clínico San Carlos, Paediatrics, Madrid, Spain, ²Hospital Clínico San Carlos, Microbiology, Madrid, Spain, ³Hospital Universitario de Getafe, Paediatrics, Madrid, Spain, ⁴HOSPITAL 12 DE OCTUBRE, Paediatrics, MADRID, Spain, ⁵Hospital Getafe, Pediatrics, Madrid, Spain, ⁶Hospital Gregorio Marañón, Pediatrics, MADRID, Spain, ⁷Hospital La Paz, Pediatric Infectious Diseases, Madrid, Spain, ⁸Hospital de Móstoles, Paediatrics, Madrid, Spain, ⁹Hospital Universitario Príncipe de Asturias, Paediatrics, Madrid, Spain, ¹⁰Hospital Universitario Severo Ochoa, Paediatrics, Madrid, Spain, ¹¹Hospital Universitario 12 de Octubre, Gynecology And Obstetrics, Madrid, Spain, ¹²Hospital Universitario Gregorio Marañón, Gynecology, Madrid, Spain, ¹³Hospital Fundación Alcorcón, Paediatrics, Madrid, Spain, ¹⁴Hospital Clínico San Carlos, Epidemiology, Madrid, Spain, ¹⁵Clínico San Carlos Hospital, Paediatrics, Madrid, Spain

Backgrounds: Nowadays HIV infection continues to be a major public health problem worldwide. Regarding to perinatal transmission, the introduction of preventive measures has achieved a marked decreased in transmission rate. Our aim was to describe the changes observed in Madrid Cohort of HIV-infected mother-infants pairs.

Methods: Multicenter, prospective, observational and cohort study of HIV-1 infected pregnant women and their infants during years 2000-2020. It collects information on clinical and epidemiologic characteristics of HIV-1 infected pregnant until delivery and their children in 9 hospitals. The results were classified in three periods: P1 between 2000-2006, P2 between 2007-2013 and P3 between 2014-2020.

Results: A total of 1521 women living with HIV and 1548 newborns were included between years 2000-2020 (27 twin). 49.2% of births occurred in P1, 30.5% in P2 and 20.3% in P3. Most of mothers (75.8%) in the first period were Spanish, with a predominance of women of foreign origin in P2 (62.8%) and P3 (70.5%). The percentage of mothers with antiretroviral treatment before pregnancy was similar in P1 and P2 and increased significantly in the third period ($p < 0.01$). Maternal hepatitis C virus coinfection decreased dramatically from P1 (47%; $n = 308$) to P3 (5.4%; $n = 11$). The proportion of caesarean sections decreased over time: 66.2% ($n = 472$) in P1, 54.9% ($n = 245$) in P2 and 46.7% ($n = 141$) in P3. The percentage of preterm and low birth weight newborns showed a statistically significant decrease. Even though there were no statistically significant differences ($p = 0.154$) a decrease in cases of perinatal infection was observed (Table

| | Period 1 (2000-2006) n (%) | Period 2 (2007-2013) n (%) | Period 3 (2014-2020) n (%) | P |
|--|-------------------------------|-------------------------------|-------------------------------|--------|
| Maternal age, mean years (SD) (n=1406) | 31.4 (± 5.2) ^b | 31.1 (± 6) ^c | 32.5 (±6.1) | < 0.01 |
| Ethnicity (n=1366) | | | | < 0.01 |
| Spanish | 555 (75.8) ^{a,b} | 130 (37.2) | 84 (29.5) | |
| Foreign origin | 177 (24.2) | 219 (62.8) | 201 (70.5) | |
| Transmission route (n=1164) | | | | < 0.01 |
| Heterosexual contact | 372 (57.9) ^{a,b} | 238 (74.6) ^c | 166 (82.2) | |
| Injection drug use | 267 (41.5) | 66 (20.7) | 9 (4.5) | |
| Perinatal transmission | 4 (0.6) | 15 (4.7) | 27 (13.4) | |
| Time of maternal HIV diagnosis (n=1344) | | | | 0.120 |
| Before pregnancy | 502 (78.7) | 314 (75.7) | 243 (83.5) | |
| During pregnancy | 123 (19.3) | 88 (21.2) | 44 (15.1) | |
| During delivery or puerperium | 13 (2) | 13 (3.1) | 4 (1.4) | |
| TARGA before pregnancy (n=1364) | | | | < 0.01 |
| Yes | 412 (62.5) ^a | 249 (60.1) ^c | 229 (78.7) | |
| No | 247 (37.5) | 165 (39.9) | 62 (21.3) | |
| HCV coinfection (n=1209) | 308 (47) ^{a,b} | 78 (22.2) ^c | 11 (5.4) | < 0.01 |
| CD4 cell count at delivery (cells/mm ³) (n=1511) | | | | < 0.01 |
| <500 | 299 (40) ^{a,b} | 151 (32.8) ^c | 100 (33.1) | |
| ≥500 | 250 (33.4) | 132 (28.6) | 136 (45) | |
| HIV viral load at delivery (copies/ml) (n=1244) | | | | < 0.01 |
| <50 | 397 (65.8) ^a | 245 (71.8) ^c | 272 (90.7) | |
| ≥50 | 206 (34.2) | 96 (28.2) | 28 (9.3) | |
| Mode of delivery (n=1461) | | | | < 0.01 |
| Vaginal | 217 (30.4) ^{a,b} | 194 (43.5) ^c | 153 (50.7) | |
| Instrumental | 24 (3.4) | 7 (1.6) | 8 (2.6) | |
| Elective cesarian section | 378 (53) | 191 (42.8) | 79 (26.2) | |
| Acute cesarian section | 94 (13.2) | 54 (12.1) | 62 (20.5) | |
| AZT intrapartum (n=1243) | 600 (90.9) ^a | 330 (88.9) ^c | 170 (80.2) | < 0.01 |
| Gestational age, mean weeks (SD) (n = 1491) | 37.6 (± 2.3) ^{a,b} | 38.1 (± 2.3) | 38.4 (± 2.2) | < 0.01 |
| Gestational age at birth < 37 weeks (n=1518) | 168 (22.5) ^a | 90 (19.5) ^c | 37 (12) | < 0.01 |
| Birth weight < 2500 g (n=1200) | 68 (12) ^a | 38 (10.3) | 17 (6.4) | < 0.05 |
| Children with withdrawal syndrome (n=1462) | 111 (15) ^{a,b} | 34 (7.9) ^c | 2 (0.7) | < 0.01 |
| Postnatal child prophylaxis (n=1502) | | | | < 0.01 |
| AZT monotherapy | 674 (90.1) ^{a,b} | 331 (74.2) ^c | 268 (87) | |
| Dual therapy | 30 (4) | 40 (9) | 7 (2.3) | |
| Triple therapy | 44 (5.9) | 75 (16.8) | 33 (10.7) | |
| Perinatal transmission (n=1548) | 12 (1.6) | 6 (1.3) | 1 (0.3) | 0.154 |

SD: standard deviation; IR: interquartile range; HCV: hepatitis C virus; AZT: zidovudine; a: statistically significant period 1 vs period 2; b: statistically significant period 1 vs period 3; c: statistically significant period 2 vs period 3

1).

Conclusions/Learning Points: The epidemiological characteristics of pregnant women with HIV have changed over time in our setting. Perinatally HIV-infected children have decreased notably in recent years. Factors such as universal TARGA in pregnancy have contributed to improve it.

EP043 / #572

Topic: AS02. Public health and epidemiology (only non SARS-CoV2 content) / AS02.a. Population studies and surveillance

DYNAMICS OF TUBERCULOSIS MORBIDITY IN CHILDREN IN UKRAINE

E-Posters

E-POSTER VIEWING

Olga Bilogortseva¹, Yaroslava Dotsenko¹, Viktoriia Khlybova¹, Inna Motrich², Olga Nedospasova³, Olena Kovaleva⁴

¹National institute of phthysiology and pulmonology named after F.G. Yanovsky NAMS of Ukraine, Pediatric Phthysiology, Kyiv, Ukraine, ²WHO Country Office, Ukraine, Who Country Office, Kyiv, Ukraine, ³Centre for Medical Statistics of the Ministry of Health of Ukraine, Centre For Medical Statistics, Kyiv, Ukraine, ⁴National institute of phthysiology and pulmonology named after F.G. Yanovsky NAMS of Ukraine, Outpatient Department, Kyiv, Ukraine

Backgrounds: Ukraine is a high TB priority country in the centre of Europe (WHO, 2021).

Methods: Epidemiological, clinical, statistical.

Results: Childhood TB incidence in Ukraine has not changed significantly over the past 10 years and was at 8.9 per 100,000 in 2019. In 2020, TB care in Ukraine deteriorated significantly due to the impact of the COVID-19 pandemic, as well as a systemic decline in quality screening of the population for TB. This led to an artificial reduction in the incidence of TB in the population in 2020 compared to 2019: children under 14 - by 34.8% (from 8.9 to 5.8 per 100,000); adolescents (15-17 years) by 27.5% (from 19.3 to 14.0 per 100,000); and adults by 30.2% (from 57.7 to 43.3 per 100,000). The relapse rate in adults as a proportion of all newly diagnosed active TB cases increased significantly, from 13.6% in 2010 to 23.0% in 2020 (1.7 times). Since 2012, there has been a steady increase in the percentage of patients under 14 years of age compared to adolescents. The incidence of TB in children shows a predominance of respiratory TB (86.7% and 95.8% in children under 14 and 15-17 years). In 2019 extrapulmonary tuberculosis (EPTB) in children under 14 years was 13.3% (TB of peripheral lymph nodes - 5.4% (31 children), TB of bone and joint system - 3.8% (22 children), TB meningitis and miliary TB were 1.6% each (9 children). Other forms of EPTB occurred only as isolated cases. In adolescents EPTB was observed in 4.2%.

Conclusions/Learning Points: Despite a gradual decrease in the incidence of TB among adults, the incidence among children in Ukraine is higher than in most European countries. There has been an increase in severe forms, including MDR-TB.

EP044 / #613

Topic: AS02. Public health and epidemiology (only non SARS-CoV2 content) / AS02.a. Population studies and surveillance

MULTIDRUG-RESISTANT TUBERCULOSIS IN CHILDREN IN UKRAINE: TRENDS SINCE 2014

E-Posters

E-POSTER VIEWING

Olga Bilogortseva¹, Iryna Shekhter¹, Vera Chechenyeva², Viktoriia Khlybova¹, Mariia Sadlovska¹, Viktoriia Shatunova¹

¹National institute of phthisiology and pulmonology named after F.G. Yanovsky NAMS of Ukraine, Pediatric Phthisiology, Kyiv, Ukraine, ²National Specialised Children's Hospital "OKHMATDYT", Center For Treatment Children With Hiv/aids, Kyiv, Ukraine

Backgrounds: Children and adolescents are significantly affected by the epidemic of MDR-TB. Approximately 25 000 children develop multidrug-resistant TB each year and 2 million are infected with MDR strains of MBT (WHO, 2016). The incidence of MDR-TB in the European Region is 25% of the global rate (WHO, 2019).

Methods: Epidemiological, clinical, statistical. The work was carried out with public funds.

Results: The dynamics of the percentage of children with DR-TB among newly diagnosed patients and retreated patients from 2014 to 2020 in Ukraine were studied. Among new cases of TB in children, the percentage of patients with DR-TB increased from 14.3% in 2014 to 37.4% in 2020. Among retreated, from 38.4% to 48.5%. The most significant increase in patients with DR-TB was from 2019 to 2020 - from 27.3% to 37.4% (an increase of 11.1%). In previous years, the increase by year ranged from 2% to 4%. In retreated patients, the percentage of DR-TB patients in the last 2 years was almost 50.0% (as in adults). In 2020, the structure of DR-TB in children in Ukraine was as follows: among newly diagnosed cases MDR-TB was 7.0%; risk of MDR-TB 15.9%; XDR-TB -2.1%; Rif-TB - 9.3%; mono- and polyresistant TB 2.5% and 0.8%, respectively.

Conclusions/Learning Points: In Ukraine an increase in the structure of clinical forms of TB in children is observed, including DR-TB. In 2020, against the background of a significant decrease in TB detection in Ukraine among adults and children, the percentage of children with DR-TB increased (by 11.1% from 2019 to 2020). Adverse dynamics include the impact of the COVID-19 pandemic and the abolition of screening for TB in children, which resulted in late detection (by referral) and significant under-detection of TB.

EP045 / #788

Topic: AS02. Public health and epidemiology (only non SARS-CoV2 content) / AS02.a. Population studies and surveillance

THE PREVALENCE OF ASYMPTOMATIC INFECTIONS WITH TICK-BORNE ENCEPHALITIS VIRUS IN THE ENDEMIC AREA IN THE NORTH-EAST OF POLAND.

E-Posters

E-POSTER VIEWING

Ewa Bojkiewicz¹, Kacper Toczyłowski¹, Sambor Grygorczuk², Piotr Czupryna², Anna Moniuszko-Malinowska², Justyna Dunaj², Agnieszka Zebrowska³, Artur Sulik¹

¹Medical University of Białystok, Department Of Pediatric Infectious Diseases, Białystok, Poland, ²Medical University of Białystok, Department Of Infectious Diseases And Neuroinfection, Białystok, Poland, ³Regional Centre of Transfusion Medicine in Białystok, Transfusion Immunology Department And Laboratory Department, Białystok, Poland

Backgrounds: The severity of tick-borne encephalitis virus (TBEV) infections ranges from asymptomatic to severe encephalitis and myelitis. The rate of the mild and asymptomatic infections is probably high, but difficult to assess. An identification of mild TBEV infections would be informative for the study of the disease pathogenesis and the knowledge of the predisposing and protective factors, both genetic and environmental.

Methods: We have studied 298 healthy blood donors from the TBE endemic area in north-east Poland for the presence of anti-TBEV IgG antibodies in a serum sample from the venous blood obtained directly before the donation. All the participants were asked about a history of anti-TBE vaccination or a diagnosed TBEV infection. The samples were analyzed with a commercial diagnostic kit detecting anti-TBEV IgG antibodies.

Results: Four subjects reported having had TBE diagnosed in the past but tested negatively for specific antibodies. 38 (13%) had a history of a prior anti-TBEV vaccination. Of the remaining 256 subjects 14 (5%) were seropositive suggesting a prior infection with TBEV with mild symptoms not requiring hospitalization or serologic diagnostics. The median antibody titer tended to be higher in seropositive non-vaccinated than in seropositive vaccinated subjects, but the difference was not significant.

Conclusions/Learning Points: The TBEV disease limited to a peripheral flu-like phase without CNS involvement is hypothesized to be a cause of undiagnosed seroconversions, however the reasons for an apparently high rate of mild cases of TBEV infection remain unclear. The study subjects with a history of such infections, identified by serologic screening, may give new insights into TBE pathogenesis and individual factors protective against a symptomatic disease.

EP047 / #1422

Topic: AS02. Public health and epidemiology (only non SARS-CoV2 content) / AS02.a. Population studies and surveillance

INCIDENCE AND TRENDS OF SEPSIS IN HOSPITALISED CHILDREN AGED 1 TO 5 YEARS IN THE MALTESE ISLANDS

E-Posters

E-POSTER VIEWING

Roberta Ellul^{1,2}, David Pace^{2,3}

¹Mater Dei Hospital, Department Of Paediatrics And Child Health, Msida, Malta, ²Mater Dei Hospital, Department Of Paediatrics And Child Health, MSIDA, Malta, ³Mater Dei Hospital, Department Of Child & Adolescent Health, MSIDA, Malta

Backgrounds: Children under 5 years of age suffer the greatest burden of sepsis globally. We aimed to study the incidence of septicaemia in 1 - 5 years olds in Malta.

Methods: All positive blood cultures in children hospitalised at Mater Dei Hospital, the only hospital providing care for the whole population in Malta, from January 2009 to December 2020 were analysed. Contaminants and isolates from children undergoing oncological treatment or from those with an indwelling central line were excluded.

Results: Over the 12 year study period there were 59 cases of confirmed septicaemia presenting at a mean age of 2.4 years (Range 1.1-5.2 years) of which 52% were males. The overall mean annual incidence rate of sepsis was 20.3/100,000 population of which Gram positive and negative organisms were responsible for incidence rates of 10.3 and 6.2/100,000, respectively. The predominant pathogen was the pneumococcus at a mean incidence rate of 4.4/100,000, followed by Staphylococcus aureus, Escherichia coli and non-typeable Haemophilus influenzae with incidence rates of 2.0, 1.4 and 1.1/100,000 respectively.

Conclusions/Learning Points: The pneumococcus was the predominant pathogen in 1-5 year old children. Routine immunisation against the pneumococcus, introduced in 2020 together with a catch up campaign in the under fives, is expected to result in control of invasive pneumococcal disease in young children.

EP048 / #1232

Topic: AS02. Public health and epidemiology (only non SARS-CoV2 content) / AS02.a. Population studies and surveillance

BORDETELLA PERTUSSIS IN THE CZECH REPUBLIC BETWEEN 1967 AND 2015: THE DETECTION OF THE SENSITIVITY OF CLINICAL ISOLATES TO ANTIBIOTICS AND COMMONLY USED DISINFECTANTS

E-Posters

E-POSTER VIEWING

Katerina Fabianova, Jan Kyncl, Jan Urban, Vera Melichercikova, Jana Zavadilova, Petra Uttlova, Vladislav Jakubu, Pavla Urbaskova
National Institute of Public Health, Centrum Of Epidemiology And Microbiology, Prague, Czech Republic

Backgrounds: Our pertussis surveillance includes also the detection of the sensitivity of clinical isolates to antibiotics and commonly used disinfectants.

Methods: 135 isolates of *B. pertussis* were tested for susceptibility to selected antibiotics. The minimum inhibitory concentrations (MICs) of first-line antibiotics were obtained by the reference agar dilution method on Bordet Gengou Agar with 15% defibrinated sheep blood. 34 clinical isolates of *B. pertussis* were tested for susceptibility to chemical disinfectants. The microsuspension method was used for the primary screening. Further testing was conducted in accordance with standard EN 14885.

Results: No strain of *B. pertussis* required a higher concentration of erythromycin, clarithromycin, azithromycin, ciprofloxacin, or co-trimoxazole for inhibition. All but a single strain, inhibited by erythromycin at a concentration of 0.03 mg/l, were inhibited by two concentrations of erythromycin and azithromycin (0.06 and 0.125 mg/l). Clarithromycin inhibited the strains from all three-study periods. Any strain was inhibited by ciprofloxacin at a single concentration of 0.06 mg/l and by trimethoprim/sulfamethoxazole at three concentrations (0.125, 0.25, and 0.5 mg/l). Disinfectant No. 1 showed bactericidal activity at a concentration of 0.5 % after 2 min of exposure in the case of immersion or at a concentration of 5 % after 2 min of exposure when treated by wiping. Disinfectant No. 2 was active at a concentration of 0.1 % after 2 min of exposure or at a concentration of 1 % after 2 min of exposure, respectively.

Conclusions/Learning Points: The study set of 135 Czech strains of *B. pertussis* appears to be homogeneous in terms of the MICs for five antimicrobials. The MICs of the study antibiotics remained in the same ranges. No tested strain was resistant to commonly used disinfectants.

EP049 / #1473

Topic: AS02. Public health and epidemiology (only non SARS-CoV2 content) / AS02.a. Population studies and surveillance

SICKLE CELL DISEASE AND G6PD DEFICIENCY: THE EXPERIENCE OF NEWBORN SCREENING IN CHILDREN ENROLLED IN THE PEDIATRIC REGISTER FOR HIV INFECTION

E-Posters

E-POSTER VIEWING

Lucrezia Melodia¹, Silvia Garazzino², Carlo Scolfaro², [Elisa Funciello](#)^{2,3}, Erika Silvestro², Giulia Pruccoli^{2,3}, Vincenzo Voi⁴, Emilia Parodi⁵, Federica Mignone²

¹University of Turin, School Of Medicine, Turin, Italy, ²Regina Margherita Children's Hospital, Pediatric Infectious Disease Unit, Turin, Italy, ³University of Turin, Department Of Sciences Of Public Health And Pediatrics, Turin, Italy, ⁴Ospedale San Luigi Gonzaga, Clinical And Biological Science Unit, Turin, Italy, ⁵A.O. Ordine Mauriziano, Newborn And Pediatric Unit, Turin, Italy

Backgrounds: SCD and G6PD deficiency are two haematological diseases for which early diagnosis allows a better clinical management of patients. The WHO recommend to plan neonatal screening in high-risk populations. Nowadays, in Italy, there is no provision for neonatal screening for these two conditions. The aim of this study is to assess the incidence of these conditions in relation to the geographical origins of the patients' parents to determine whether there are populations worthy of being involved in a targeted screening program.

Methods: At the Infectious Diseases Clinic of the Regina Margherita Children's Hospital in Turin, 350 patients, born from HIV positive mothers between January 2011 and December 2020, were enrolled; 334 of them were submitted to the screening for SCD (HPLC method) and 322 to that G6PD deficiency (UV quantitative test).

Results: Haemoglobinopathy screening identified 35 patients with sickle cell trait and 2 with SCD. A third of known familiarity resulted from tests carried out in older siblings, also enlisted in this study. All screening-positive patients are children of women from sub-Saharan Africa (SSA), with a significant difference ($p < 0.01$) compared to the children of women born in other geographical areas. Screening for G6PD deficiency identified 15 affected boys and 12 girls with reduced enzyme activity resulting from the unfavorable lyonization of X. The 85% of them are children of mother with origins in SAA, with a significant difference ($p < 0.01$) compared to the other children.

Conclusions/Learning Points: Newborns from HIV positive mothers coming from SSA could benefit from targeted neonatal screening programmes for SCD and G6PD deficiency, to ensure them timely diagnosis and an early communication of the carriers' condition.

EP050 / #1138

Topic: AS02. Public health and epidemiology (only non SARS-CoV2 content) / AS02.a. Population studies and surveillance

DIPHTHERIA CASES REMAINS LOW IN 2022 IN EAST JAVA PROVINCE, INDONESIA

E-Posters

E-POSTER VIEWING

Dominicus Husada¹, Leny Kartina², Dwiyantri Puspitasari², Parwati Basuki², Ismoedijanto Moedjito², Mvs Mahanani³, Gito Hartono³, Hugeng Susanto³, Wiwien Puspitasari³

¹Faculty of Medicine Universitas Airlangga / Dr. Soetomo Hospital, Child Health, Surabaya, Indonesia, ²Airlangga University / Dr Soetomo Hospital, Child Health, Surabaya, Indonesia, ³East Java Provincial Health Office, Surveillance, Surabaya, Indonesia

Backgrounds: Covid-19 pandemic influences many other infectious diseases. East Java Province has been suffered from a high number of diphtheria cases for more than a decade. Between 2020 and 2021, the number of diphtheria cases in the province reaches the lowest level. The objective of this study was to describe the surveillance report of diphtheria cases in East Java Province in 2021.

Methods: This was a surveillance study based on daily, weekly, and monthly report from 38 districts for 2021. The sources of the report were hospitals, community health centers, doctors, and paramedics. The report consists of many aspects, including demographical, clinical, and laboratory. All reports were collected at the Provincial Health Office. All cases were reconfirmed by the national expert committee. The microbiological culture was performed at Public Health Laboratory in Surabaya.

Results: During 2021, 57 cases were recorded from 23/38 districts. This was the lowest number in a decade. This province contributes one third of all diphtheria patients in Indonesia. Most of the patients were less than 15 years of age. Five districts did not have any cases for the last two years. Two cases were died in 2021, with a CFR of 3.51%. The positivity of microbiological culture remains low, with only 1.8% showing toxigenic *C. diphtheriae*.

Conclusions/Learning Points: During the pandemic era, the incidence of diphtheria in East Java Province was decreasing.

EP051 / #1470

Topic: AS02. Public health and epidemiology (only non SARS-CoV2 content) / AS02.a. Population studies and surveillance

ROTAVIRUS SURVEILLANCE DURING COVID-19 PANDEMIC

E-Posters

E-POSTER VIEWING

Dimitra Maria Koukou¹, Elizabeth- Barbara Tatsi¹, Charilaos Dellis¹, George Trimis², Levantia Zachariadou³, Evaggelia Eirini Vetouli⁴, Theodota Liakopoulou⁵, Athanasios Michos¹, Vassiliki Syriopoulou¹

¹"Aghia Sophia" Children's Hospital, Division Of Infectious Diseases, First Department Of Pediatrics, Medical School, National And Kapodistrian University Of Athens, Athens, Greece, Athens, Greece, ²MSD, Medical And Scientific Affairs, Athens, Greece, ³"Aghia Sophia" Children's Hospital, Department Of Microbiology, Athens, Greece, ⁴"P. & A. Kyriakou" Children's Hospital, Department Of Microbiology, Athens, Greece, ⁵Iaso Children's Hospital, Department Of Pediatrics, Athens, Greece

Backgrounds: The COVID-19 pandemic has dramatically changed people's lives since December 2019. Implementation of measures to prevent the transmission of SARS-CoV-2 has led to significant changes in the epidemiology of other viral infections. The aim of this study was to describe the changes in Rotavirus (RV) epidemiology during the first 2 years of the pandemic.

Methods: Demographic data and fecal samples were collected from children ≤16 years old, hospitalized with RV gastroenteritis (RVGE) in 3 Pediatric Departments during 09/2019-08/2021. Samples were tested for RV Group A antigen with rapid immunochromatographic assay. Positive samples were further G and P typed with RT-PCR, semi-nested multiplex PCR and Sanger sequencing of the VP7 and VP4 genes.

Results: A total of 259 children with RVGE participated in the study (males; 59.8%) with median age 2.5 years (IQR;1.1-6.9). During 2019/20, 103/259 children (39.8%) were detected and RV seasonal peak was observed in January-March. During 2020/21, RV seasonal peak was observed in May-June. RV strains with frequency>1% were the following: G1P[8];40.8%, G2P[4];22.7%, G9P[8];12.9%, G9P[4];4.3%, G3P[8];3.5%, G12P[8];3.1%, G3P[9];2.7%, G1P[4];2.0% and G8P[14];1.2%. Uncommon combinations and mixed genotypes were both identified in 3.2% of the samples. Interestingly the common genotype G4P[8] was detected only in 0.4% of the children. During both years G1P[8] and G2P[4] were the commonest genotypes followed by G9P[4] in 2019/20 and G9P[8] in 2020/21.

Conclusions/Learning Points: Less children with RV gastroenteritis were hospitalized during the first year of the pandemic. Changes in the seasonality and genotype distribution were also observed; increased detection of G2P[4], G9P[8] and G9P[4] and very low percentages of G4P[8] which used to be one of the two commonest strains in Greece. Continuous surveillance of RV molecular genotyping is important even in periods with low RV prevalence.

EP052 / #941

Topic: AS02. Public health and epidemiology (only non SARS-CoV2 content) / AS02.a. Population studies and surveillance

WHOLE GENOME SEQUENCING OF NEISSERIA MENINGITIDIS Y COLLECTED IN THE CZECH REPUBLIC IN 1993-2018

E-Posters

E-POSTER VIEWING

Pavla Krizova, Michal Honskus

National Institute of Public Health, Centre For Epidemiology And Microbiology, Prague, Czech Republic

Backgrounds: The study presents the analysis of whole genome sequencing (WGS) data for *Neisseria meningitidis* serogroup Y isolates collected in the Czech Republic and their comparison to other countries. The aim of the study was to determine whether there are lineages of *N. meningitidis* serogroup Y in the Czech Republic genetically related to foreign ones that have been causing an increase of the morbidity and the mortality of invasive meningococcal disease (IMD) world-wide recently.

Methods: The WGS data of 43 Czech *N. meningitidis* Y isolates, 35 from IMD and 8 from healthy carriers were analysed. The WGS data of Czech, European and non-European isolates of *N. meningitidis* serogroup Y were compared.

Results: WGS assigned 36 isolates of *N. meningitidis* Y to five clonal complexes: cc23, cc92, cc167, cc103, and cc174, while seven isolates remained unassigned to any clonal complexes (ccUA). Eighteen invasive isolates belonged to clonal complex cc23, which was detected throughout the studied years. The occurrence of cc23 was recorded in all age groups of IMD patients, with the highest found in those aged 15-19 years. On the phylogenetic network isolates of cc23 form a separate lineage, distinct from all other isolates of *N. meningitidis* Y. The comparison with foreign WGS data showed that within the main genetic lineages, which are defined by clonal complexes, Czech isolates of *N. meningitidis* Y, similar to European ones.

Conclusions/Learning Points: The Czech isolates of *N. meningitidis* Y follow the trend observed for European isolates. Our result was one of the bases for updating the recommended vaccination strategy in the Czech Republic. Project support Supported by Ministry of Health of the Czech Republic, grant no. NV19-09-00319. All rights reserved.

EP053 / #636

Topic: AS02. Public health and epidemiology (only non SARS-CoV2 content) / AS02.a. Population studies and surveillance

A POPULATION-BASED STUDY REVEALS SIGNIFICANT REDUCTION OF INFLUENZA AND INVASIVE MENINGOCOCCAL DISEASE AMONG GREEK CHILDREN DURING THE COVID-19 PANDEMIC

E-Posters

E-POSTER VIEWING

Danai Ktena¹, Eleni Kourkouni², Flora Kontopidou³, Kassiani Gkolfinopoulou⁴, Kalliopi Papadima⁵, Theano Georgakopoulou⁶, Ioanna Magaziotou⁶, Anastasia Andreopoulou⁵, Georgina Tzanakaki⁷, Theoklis Zaoutis^{8,9}, Vassiliki Papaevangelou¹

¹National and Kapodistrian University of Athens, Third Department Of Paediatrics, Attikon University Hospital, Athens, Greece, ²Center for Clinical Epidemiology and Outcomes Research (CLEO), Center For Clinical Epidemiology And Outcomes Research (cleo), Athens, Greece, ³National Public Health Organization, Directorate Of Epidemiological Surveillance, Athens, Greece, ⁴National Public Health Organization, Department Of Surveillance Systems, Directorate Of Epidemiological Surveillance And Interventions For Infectious Diseases, Athens, Greece, ⁵National Public Health Organization, Department Of Respiratory Diseases, Directorate Of Epidemiological Surveillance And Interventions For Infectious Diseases, Athens, Greece, ⁶National Public Health Organization, Department For Vaccine Preventable Diseases & Congenital Diseases, Directorate Of Epidemiological Surveillance And Interventions For Infectious Diseases, Athens, Greece, ⁷University of West Attica, National Meningitis Reference Laboratory, Department Of Public Health Policy, Athens, Greece, ⁸National and Kapodistrian University of Athens, Second Department Of Paediatrics, P&a Kyriakou Children's Hospital, Athens, Greece, ⁹National Public Health Organization, President, Athens, Greece

Backgrounds: Aiming to the containment of the coronavirus disease 2019 (COVID-19) pandemic, governments worldwide have implemented a series of non-pharmaceutical interventions. Many of them and especially school closures have impacted the circulation of multiple airborne pathogens among children and adolescents. This study investigates the incidence of influenza and Invasive Meningococcal Disease (IMD) among children aged 0-14 years in Greece during the COVID-19 pandemic.

Methods: Data regarding the number of Influenza-Like Illness (ILI) cases, influenza-related Paediatric Intensive Care Unit (PICU) admissions and IMD cases among children 0-14 years old were obtained from the National Public Health Organization (NPHO). The incidence of the two diseases during the COVID-19 pandemic period (2020/2021) was compared to that of the six preceding seasons (2014 – 2019).

Results: A notable decrease was observed in both influenza and IMD cases during the period 2020/2021 compared to the years 2014-2019. The average yearly rate of ILI cases and influenza-related PICU admissions in children 0-14 years old has reduced by 66.9% and 100% respectively, while the average yearly IMD rate has declined by 70%. Both weekly ILI and monthly IMD rates were statistically significantly decreased.

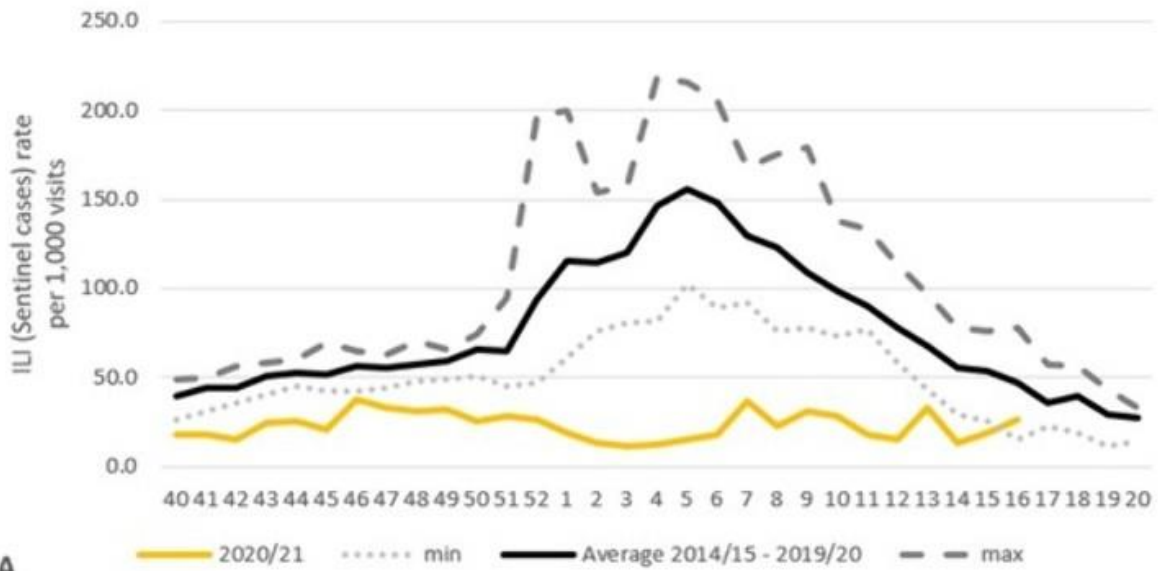

A

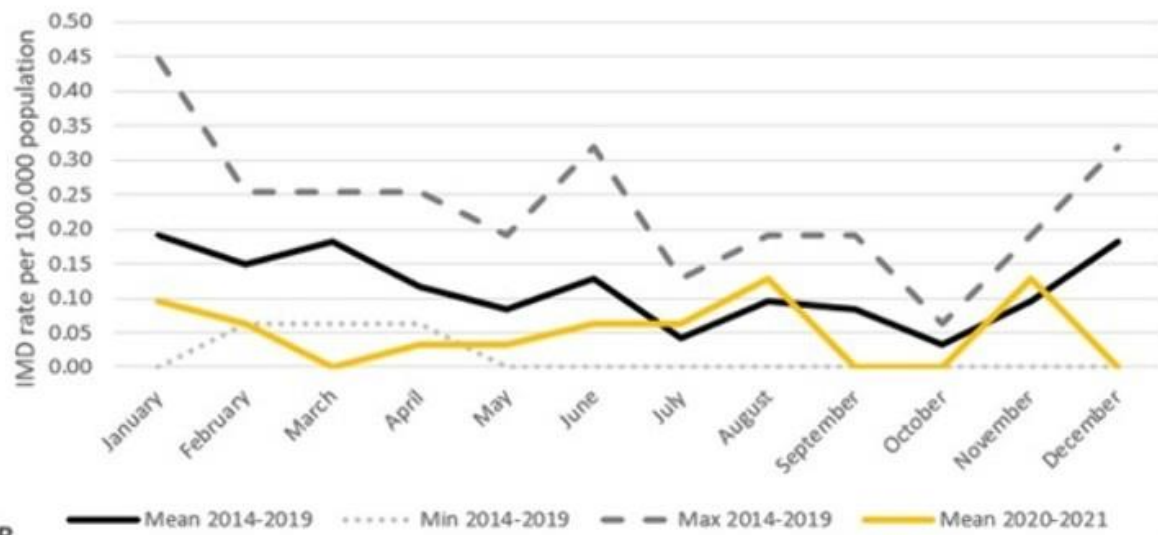

B

Conclusions/Learning Points: The activity of influenza and IMD in the children and adolescents of Greece has decreased during the COVID-19 pandemic period. Reduced transmission is likely related to the public health measures that were implemented to control the pandemic. The value of these measures may have relevance to the future management of influenza or IMD epidemics.

EP054 / #1026

Topic: *AS02. Public health and epidemiology (only non SARS-CoV2 content) / AS02.a. Population studies and surveillance*

UNFAVOURABLE TREND IN TICK-BORNE ENCEPHALITIS INCIDENCE IN THE CZECH REPUBLIC

E-Posters

E-POSTER VIEWING

Jan Kyncl, Hana Orlikova, Katerina Fabianova

National Institute of Public Health, Dept. Of Infectious Diseases Epidemiology, Prague, Czech Republic

Backgrounds: Tick-borne encephalitis (TBE) is a severe acute neuroinfection transmitted predominantly by tick bite or consumption of raw milk. The incidence of TBE is particularly high in Central Europe but foci of infection are still spreading to other countries as well as to higher altitudes. The disease affects all age groups including children. With increasing age, both the clinical severity of the disease and the risk of complications and sequelae increase. There is an effective, safe and well-tolerated vaccine against TBE, which in practice shows 96-99% effectiveness.

Methods: Retrospective descriptive analysis of case-based TBE data from the Czech nationwide infectious disease reporting system.

Results: In 2020, 854 TBE cases were reported in the Czech Republic with an incidence of 7.98 per 100,000 inhabitants, which represents the highest morbidity in the last 9 years and a continuation of the increase in incidence for six years, although the highest number of cases reported in 2006 was not exceeded. The incidence of tick-borne encephalitis in children and adolescents is increasing; on average it represents 15.2% of all reported cases in 2015-2019. According to preliminary data for 2021, 587 TBE cases were reported in the Czech Republic but the proportion in children and adolescents was already 17.7%.

Conclusions/Learning Points: The Czech Republic is one of the countries with the highest TBE incidence in Europe and the number of cases is moreover increasing. The proportion of TBE in children and adolescents is growing. Vaccine prevention is desirable in all age groups.

EP055 / #411

Topic: AS02. Public health and epidemiology (only non SARS-CoV2 content) / AS02.a. Population studies and surveillance

SEROPREVALENCE OF WEST NILE VIRUS INFECTION IN A PAEDIATRIC POPULATION IN SEVILLE (SPAIN)

E-Posters

E-POSTER VIEWING

Inés Marín-Cruz¹, Ana Vázquez-González², Walter Goycochea-Valdivia¹, Laura Olbrich¹, Luis Luque-Romero³, Pilar Blanco-Lobo⁴, Olaf Neth¹

¹Hospital Universitario Virgen del Rocío, Paediatric Infectious Diseases, Rheumatology And Immunology, Seville, Spain, ²National Microbiology Centre - Carlos III Health Institute, Arbovirus And Imported Viral Diseases Laboratory, Majadahonda, Spain, ³Distrito Sanitario Aljarafe-Sevilla Norte, Research Unit, Seville, Spain, ⁴Institut of Biomedicine of Seville, Inborn Errors Of Immunity Laboratory, Seville, Spain

Backgrounds: West Nile virus (WNV) is an emerging mosquito-borne Flavivirus being endemo-epidemic in southern, eastern, and western Europe. About 80% of WNV infections are asymptomatic in adults, and its most characteristic manifestations include West Nile fever (WNF) and WNV neuroinvasive disease (WNVND)(<1%), but the proportion of these manifestations in children is unknown.

Methods: A prevalence study was performed including children aged <14 years from Coria del Río (most affected town during the 2020 WNV outbreak in Spain) whose legal guardians signed an informed consent. The main study variable was WNV infection, defined as positive WNV serology (IgM/IgG) confirmed by neutralization test (NT). Secondary variables were age, sex, geographical area, mosquito exposure, and clinical manifestation. Selectable population was obtained from a census list, stratified, and randomized; selected participants were recruited telephonically until calculated sample size was reached (n=209). Blood sample was obtained to perform ELISA IgM/IgG and a clinical questionnaire was filled in by parents. Positive serologies were confirmed by NT and, to rule out cross-reactivity, other Flavivirus serologies were performed.

Results: Of 209 participants, 5 had positive WNV serology (3 IgG only, 2 both IgM and IgG). Of these 5, only 3 were confirmed by NT, being the other 2 cross-reactivities to other Flavivirus (Dengue, participant from Bolivia, and Usutu, that is known to be circulating in the area). The seroprevalence was 1.44 (IC95% 0.30-4.14). Of these 3 confirmed WNV infections, 1 (33%) had WNF and 2 (67%) were asymptomatic. All 3 cases were female, aged 8-12 years, lived far from the river, and used DEET mosquito repellent.

Conclusions/Learning Points: We report for the first time the WNV seroprevalence in children and the proportion of its manifestations, which appears similar to that in the adults.

EP056 / #316

Topic: AS02. Public health and epidemiology (only non SARS-CoV2 content) / AS02.a. Population studies and surveillance

COULD THIS BE LYME DISEASE?

E-Posters

E-POSTER VIEWING

Patrick Nee

Liverpool John Moores University, Faculty Of Health, Liverpool, United Kingdom

Title of Case: Could This Be Lyme Disease?

Background: Lyme disease (LD) is an emerging infectious disease and a major concern for the public health. If it disseminates, the disease can affect multiple systems and may lead to life-threatening complications. Early antibiotic treatment limits the impact of the disease. We present a case of early disseminated LD causing acute arthritis in a child and discuss the epidemiology, clinical features, diagnosis and treatment of the disease.

Case Presentation Summary: A six-year-old boy was brought to the Emergency Department (ED) in mid-April. His mother reported a one-day history of pain and swelling to the child's right knee. The school nurse had noted a slight limp in the morning but attributed it to a weekend of football, though no discrete injury had been reported. While at school, his pain worsened and he developed swelling of the knee and a low-grade fever of 37.5 °C. There had been no vomiting, chills, stool changes or skin rash. There was no history of tick bite, although the patient lived in an area endemic for ticks. The child was otherwise healthy without chronic medical conditions and he was not taking any regular medications. He was fully immunised and there were no drug allergies.



Learning Points/Discussion: Tick bites, and the development of the characteristic skin rash if ignored may progress to a multisystem disorder.

EP057 / #1776

Topic: AS02. Public health and epidemiology (only non SARS-CoV2 content) / AS02.a. Population studies and surveillance

LYME ARTHRITIS IN A CHILD

E-Posters

E-POSTER VIEWING

Patrick Nee¹, Nathan Mick², Andrew McNally³, Olivia Villegas³, Madhur Vardhan³

¹Liverpool John Moores University, Faculty Of Health, Liverpool, United Kingdom, ²Maine Medical Center, Emergency Medicine, Portland, United States of America, ³Whiston Hospital, Emergency Medicine, Liverpool, United Kingdom

Title of Case: LYME ARTHRITIS IN A CHILD

Background: Lyme disease (LD) is caused by a bacterium carried by ticks. LD is a major concern for the public health. Symptoms often follow an indolent course and patients may not recall a tick bite. If it disseminates the disease can affect multiple systems. Prompt diagnosis and antibiotic treatment usually lead to complete recovery.

Case Presentation Summary: A six year-old boy was brought to the ED endemic with painful swelling of the right knee. There was no history of tick bite, although the patient lived in an area endemic. He had a mild fever and no skin rash. ELISA and Western Blot tests were positive for Lyme disease IgG and IgM antibodies, confirming recent infection with *Borrelia burgdorferi*. The patient was treated with amoxicillin and improved within two days.

Learning Points/Discussion: The incidence of Lyme borreliosis is increasing and there are 30 deaths a year in the United States due to complications. This case of Lyme arthritis originated in an endemic area and posed no diagnostic difficulty, although there was no history of tick bite and no signs of the characteristic erythema migrans rash. Treatment was begun on clinical suspicion and the condition improved. In other geographic locations the disease may present more of a diagnostic challenge. Tick bites, and the development of the characteristic rash, may be ignored and the progression to a multisystem disorder often leads to confusion among clinicians. Prompt diagnosis and treatment improve outcomes. There are accepted international standards for serological testing for LD and the nature and duration antibiotic treatment. Prevention of tick bites and removal of ticks are the only effective preventative measures against the disease. There is no currently available immunisation against LD.

EP058 / #801

Topic: AS02. Public health and epidemiology (only non SARS-CoV2 content) / AS02.a. Population studies and surveillance

EFFECTIVENESS OF PNEUMOCOCCAL CONJUGATE VACCINES (PCV7-PCV13) ON DISEASE BURDEN OF ALL CAUSE PNEUMONIA, BACTERIAL PNEUMONIA AND EMPYEMA IN CHILDREN

E-Posters

E-POSTER VIEWING

Halil Özdemir¹, Chakan Tsakir², Gül Arga¹, Kübra Konca¹, Esra Çakmak Taşkın¹, Duygu Öcal³, Ergin Çiftçi¹, Erdal Ince¹

¹Ankara University Faculty of Medicine, Pediatric Infectious Diseases, Ankara, Turkey, ²Ankara University Faculty of Medicine, Pediatrics, Ankara, Turkey, ³Ankara University Faculty of Medicine, Medical Microbiology, Ankara, Turkey

Backgrounds: The aim of this study was to examine the changings in the burden of all-cause pneumonia, bacterial pneumonia and empyema in children aged 0-18 years after the implementation of 7-valent pneumococcal vaccine (PCV7) and 13-valent pneumococcal vaccine (PCV13) in the national childhood vaccination schedule in Turkey.

Methods: Children aged 0-18 years who were hospitalized with the diagnosis of pneumonia and treated at Ankara University Faculty of Medicine, Department of Pediatric Infectious Diseases between January 1, 2006 and December 30, 2019 were included in the study. IBM SPSS Statistics 20 program was used in the evaluations and $p < 0.05$ was accepted as the statistical significance limit.

Results: When pre-PCV13 (PCV7 period and pre-vaccine period together) and post-PCV13 periods are compared, in all age groups ($p < 0.001$), in children aged 0-24 months ($p < 0.001$) and 24-60 months ($p < 0.05$) disease burden due to all-cause pneumonia was significantly decreased. No significant difference was found in children aged over 60 months after PCV13 period. After PCV13 vaccine, the disease burden due to bacterial pneumonia was found to be significantly lower in all age groups ($p < 0.001$), in children aged 0-24 months ($p < 0.001$), and in children aged over 60 months ($p < 0.01$) compared to the pre-vaccine period. No significant difference in the disease burden due to bacterial pneumonia was found in children aged 24-60 months after PCV13 period. In all age groups no significant difference was found in the disease burden of empyema due to low patient numbers included in the study.

Conclusions/Learning Points: When the periods before and after PCV13 were compared, there was a significant decrease in the disease burden due to all-cause pneumonia and bacterial pneumonia in all age groups.

EP059 / #700

Topic: AS02. Public health and epidemiology (only non SARS-CoV2 content) / AS02.a. Population studies and surveillance

TRENDS IN VARICELLA EPIDEMIOLOGY AFTER INTRODUCTION OF ROUTINE CHILDHOOD VARICELLA VACCINATION IN ARGENTINA: A 12-YEAR NATIONAL TIME-SERIES ANALYSIS

E-Posters

E-POSTER VIEWING

Norberto Giglio¹, Pieralessandro Lasalvia², [Manjiri Pawaskar](#)³, Yaneth Gil-Rojas², Cintia Parellada⁴, Paula Micone⁵, Virginia Babic⁶, Silvina Neyro⁷

¹Hospital de Niños Ricardo Gutierrez, Epidemiology Department, Buenos Aires, Argentina, ²NeuroEconomix, Department Of Health Economics, Bogota, Colombia, ³Merck & Co., Inc., Center For Observational And Real-world Evidence, Kenilworth, United States of America, ⁴MSD Brazil, Center For Observational And Real-world Evidence, São Paulo, Brazil, ⁵Hospital Carlos G Durand, Obstetrics, Buenos Aires, Argentina, ⁶MSD Argentina, Medical Affairs, Buenos Aires, Argentina, ⁷Ministerio de Salud de la Nación, Dirección De Control De Enfermedades Inmunoprevenibles (dicei), Buenos Aires, Argentina

Backgrounds: One-dose live varicella virus vaccine (Oka/Merck) was introduced in the national immunization program in Argentina in July 2015 targeting children aged 15 months. We assessed the impact of one-dose universal varicella vaccination (UVV) on varicella epidemiology in Argentina.

Methods: We obtained varicella incidence and mortality data for the pre-UVV period (Jan 2008-June 2015) and post-UVV period (July 2015-Dec 2019) for the target (1-4 years old) and overall (all age groups) population from official national databases. A time-series analysis with AutoRegressive Integrated Moving Average modelling was performed to estimate expected varicella incidence and mortality without vaccination, compared with observed values in the post-UVV period. We analysed the data in peak (September-November) and non-peak periods (rest of the year).

Results: National vaccination coverage ranged from 44.8% in 2015 to 77.7% in 2019. We estimated that one-dose UVV prevented 51,203 and 92,882 varicella cases in the target and overall population, respectively, in the post-UVV peak periods. Mean annual incidence declined from 1,999.1 to 1,121.5 per 100,000 in the target population and 178.0 to 153.6 per 100,000 in the overall population, from pre to post-UVV periods. Strong seasonal peaks were observed between September and November during 2008-2016. Significant reduction in incidence were observed during peaks starting 2017, reaching reductions of 83.9% (95%CI:58.9;90%) and 69.1% (95%CI:23.6;80.7%) in 2019 in the target and overall population, respectively. There were no significant differences in non-peak periods. While we observed reductions in mortality over time, differences were not statistically significant.

Conclusions/Learning Points: This study found significant reductions in varicella cases and incidence during peak periods in the target population; and evidence of indirect effects of varicella vaccination in the overall population after one-dose UVV implementation in Argentina.

EP060 / #1802

Topic: AS02. Public health and epidemiology (only non SARS-CoV2 content) / AS02.a. Population studies and surveillance

RESPIRATORY SYNCYTIAL VIRUS BRONCHIOLITIS IN A PEDIATRIC WARD OF NORTHERN ITALY: HOW COVID19 PANEMIC CHANGED THE EPIDEMIOLOGY

E-Posters

E-POSTER VIEWING

Alessandro Porta, Marta Bellini, Francesca Lizzoli, Luciana Parola
Hospital of Magenta (Milan, Italy), ASST Ovest Milanese, Pediatric, Neonatal And Neonatal Pathology Units, Magenta (Milan), Italy

Title of Case: RESPIRATORY SYNCYTIAL VIRUS BRONCHIOLITIS IN A PEDIATRIC WARD OF NORTHERN ITALY: HOW COVID19 PANEMIC CHANGED THE EPIDEMIOLOGY

Background: Respiratory Syncytial Virus (RSV) is an important cause of low respiratory tract infection in infants, with particular severity in the first months of life. COVID19 pandemic, and consequent health restrictions, changed circulation of many infectious diseases agents, with impact on pediatric hospital admissions. We describe the admissions rate of RSV infection observed in the last 4 years, comparing trend of RSV bronchiolitis admitted in the last 5 winter seasons in the pediatric ward of the Hospital G. Fornaroli of Magenta (Milan, Italy).

Case Presentation Summary: During the three winter seasons before COVID19 pandemic (from September 2017 to March 2020), RSV bronchiolitis admissions usually started with few cases on November and a following peak between December and February, with a decrease on March/April. 39 infants were admitted to this cause during 2017/2018 winter season (from November to March, 6.5% of pediatric admissions), 56 during 2018/2019 (9.8%) and 42 during 2019/2020 (8.1%). After the beginning of COVID19 pandemic, no cases of RSV bronchiolitis were admitted at all during 2020/2021 winter season, with an important outbreak the following year: 35 patients admitted to RSV bronchiolitis on November 2021, 47 from November to January 2022, accounting 20.4% of pediatric admissions considering the three months (30.7% considering only November 2021).

Learning Points/Discussion: During COVID19 pandemic, health measures performed (social distancing, lockdown, improvement of hand washing, use of facial mask) changed significantly the epidemiology of RSV infection in infants. The consequent reduction of these measures during summer/autumn 2021 led to an important recrudescence of RSV diffusion, with a significant impact on pediatric admissions.

EP061 / #1539

Topic: AS02. Public health and epidemiology (only non SARS-CoV2 content) / AS02.a. Population studies and surveillance

MYCOBACTERIUM INVASIVE DISEASE IN CHILDREN 2010-2019

E-Posters

E-POSTER VIEWING

Ana Rodrigues, José Gonçalo Marques
CHULN - Hospital Santa Maria, Pediatrics, Lisboa, Portugal

Backgrounds: Invasive tuberculous and nontuberculous mycobacterial (NTM) infections in children are usually associated with underlying disease as pulmonary conditions, intravenous catheter or immunosuppression, with a substantial morbidity and mortality.

Methods: A retrospective 10-year period (2010-2019) study of bacterial invasive disease (BID) was conducted in a tertiary hospital. A subgroup of children with Mycobacterium detected on normally sterile body fluids was analyzed. Newborns were excluded. Statistical analysis was performed using IBM SPSS Statistics®.

Results: Mycobacterium spp were isolated in 17 cases (5% of 347 cases of BID) of which six on pleural fluid, six on pus from deep abscesses and five on cerebrospinal fluid. Nine (53%) were boys, one 1-2 months-old, three 3-35 months, one 3-9 years-old and 12 (70%) ≥ 10 years-old. The sites of infection were: pulmonary 53% (n=9), meningitis 29% (n=5), skin and soft tissue 12% (n=2) and osteoarticular 6% (n=1). Mycobacterium tuberculosis complex was identified in 15 (88%); Mycobacterium chelonae in one and Mycobacterium abscessus in one. Thirteen (76,5%) had been vaccinated with BCG. Four meningitis cases were due to M. tuberculosis complex (14 and 15 months, 8 and 15 years-old; one vaccinated with BCG, two non-vaccinated, one unknown) and one due to M. abscessus (13 years-old). NTM were associated with skin and soft tissue infections. Only the patient with M. abscessus meningitis had previous chronic disease (ventricular-peritoneal shunt). Four (24%) patients didn't have BCG vaccine. Nine children (53%) survived without any sequelae, seven (41%) with sequelae (3 non-vaccinated with BCG) and one (6%) with meningitis due to M. tuberculosis complex died (BCG status unknown).

Conclusions/Learning Points: Mycobacterium infections were almost all due to M. tuberculosis complex. Unfortunately no further species identification was performed. Mycobacteria are still an important cause of BID in previously children with high morbidity.

EP062 / #703

Topic: AS02. Public health and epidemiology (only non SARS-CoV2 content) / AS02.a. Population studies and surveillance

EPIDEMIOLOGICAL SITUATION OF ACUTE RESPIRATORY INFECTIONS IN ALBANIAN CHILDREN DURING THE PANDEMIC YEAR 2020

E-Posters

E-POSTER VIEWING

Laureta Sadedini¹, Ergena Neziri¹, Gjeorgjina Kuli-Lito², Diana Shtembari², Mirzana Kapllanaj³, Ferit Zavalani², Bashkim Nezaj²

¹Mother Theresa, Hospital Center, Tirana, Albania, Emergency Department, Tirane, Albania, ²Mother Theresa Hospital Center, Tirana, Albania, Pediatric Infection Disease Department, tirana, Albania, ³Mother Teresa Hospital Center, Albania, Onco-hematology Pediatric Department, tirana, Albania

Backgrounds: Acute respiratory infections (ARI) are common in pediatric population and the major presenting situation in Emergency Department (ED) of our hospital too. Before the year 2020 we had a large number of ARI cases, approximately 30000 children each year. During this year we noted a markedly decrease in total ED visits including ARI cases. The causative agents are transmitted by respiratory route.

Methods: The aim of this study was to show the epidemiological data, risk factors, clinical characteristics, its complications and the tendency of this disease. In study are included all children with signs of ARI aged from 1 month to 14 years old, presented in Pediatric Emergency room of University Hospital Center Mother Teresa of Tirana, during the period 1 January to 31 December 2020.

Results: 13066 children were presented with signs of acute respiratory infections. Among them 1112 (8.5%) were severe cases which have been admitted to hospital. Age group most affected was 1 month to 4 years with 4800 (36.7%) cases, which is the major group for severe cases too, followed by group age 1-4 years old with 4425 (33.8%) cases and age group 5-14 years old with 3841 (29.3%) cases. The peak was in January. ARI were presented as acute laryngitis, bronchiolitis, bronchitis, pneumoniae, etc.. The majority of hospitalization rate were bronchiolitis cases some of which related to SARS-Co2 virus

Conclusions/Learning Points: ED visits with ARI have declined since the onset of Covid-19 pandemic. Measures to prevent Covid-19 spread had a great impact on reducing the incidence of common airway infections that are spread by the respiratory route and direct contact too. The quarantine, the closure of school and day care, limitation of social activities, wearing the facial mask, led to significant drop in ARI in our hospital

EP063 / #1801

Topic: AS02. Public health and epidemiology (only non SARS-CoV2 content) / AS02.a. Population studies and surveillance

MONITORING ROUTINE CHILDHOOD VACCINATION COVERAGE DURING A GLOBAL PANDEMIC

E-Posters

E-POSTER VIEWING

Chen Stein-Zamir^{1,2}, Nitza Abramson¹, Hanna Shoob¹

¹Ministry of health, Jerusalem District Health Office, Jerusalem, Israel, ²The Hebrew University of Jerusalem, Faculty Of Medicine, Jerusalem, Israel

Backgrounds: Childhood vaccinations prevent morbidity and mortality from vaccine-preventable diseases and provide a cost-effective intervention to improve health equity. While the national vaccination coverage in Israel is adequate, gaps between population groups exist. We evaluated vaccination coverage in Jerusalem, a district with recurrent vaccine-preventable diseases' outbreaks before and during the COVID-19 pandemic.

Methods:: Routine childhood vaccinations are included in the National Health Insurance Law. Community-based clinics provide free vaccination to all children regardless of civil status. Vaccination Coverage (VC) was appraised based on the National Immunization Registry data among children (born 01/01/2018–30/06/2020, Jerusalem district). The vaccines included: Diphtheria, Tetanus, acellular Pertussis, polio, Haemophilus influenzae b (DTaP-IPV-Hib4: dose 4); pneumococcal conjugate (PCV3: dose 3) and Measles-Mumps-Rubella/Measles-Mumps-Rubella-Varicella (MMR /MMRV1), all scheduled at 12 months. Allocation into Jerusalem's main population groups (Arab, Jewish Ultra-Orthodox and Jewish traditional-secular) was based on neighborhood of residence.

Results: The study group included 71,495 children in the Jerusalem district: 28,722 were born in 2018, 28,894 in 2019 and 13,879 in the first half of 2020. The overall VC was 93.6% for MMR/MMRV, 83.2% for DTaPIPv-Hib4 and 86.7% for PCV3. The VC was higher in the 2018 cohort than in the 2019 cohort with decline among children born in 2020. The VC disparities between the cohorts were significant. Comparing VC between population groups revealed significantly lower rates among children residing in Jewish Ultra-Orthodox communities.

Conclusions/Learning Points: Childhood vaccination coverage rates and timeliness among children in Jerusalem district were suboptimal. The lowest VC rates were found in children born in the first half of 2020 in Jewish Ultra-Orthodox communities. Community-based health education campaigns to advance awareness about and trust in childhood vaccines and sustainable public health programs are essential.

EP064 / #1616

Topic: AS02. Public health and epidemiology (only non SARS-CoV2 content) / AS02.a. Population studies and surveillance

KNOWLEDGE AND EDUCATIONAL NEEDS ABOUT TICK-BORNE DISEASES IN NORTHEASTERN POLAND

E-Posters

E-POSTER VIEWING

Artur Sulik, Ewa Bojkiewicz, Dawid Lewandowski, Marta Wozinska-Klepadlo, Kacper Toczyłowski
Medical University of Białystok, Department Of Pediatric Infectious Diseases, Białystok, Poland

Backgrounds: Tick-borne diseases (TBD) are endemic in north-eastern part of the country. Lyme disease and tick borne-encephalitis (TBE) are the most prevalent diseases transmitted by ticks in this area. Lyme disease vaccine candidate is still in clinical development today so steps to prevent the disease include proper dressing, using insect repellents, removing ticks promptly. In contrast TBE is a vaccine preventable disease with a vaccine licensed for both adults and children. In our study we aimed at investigating the knowledge about ticks, TBD and available preventive measures related to tick bites to assess educational needs regarding TBD.

Methods: A study was conducted from December'19 till September'21. Parents of children hospitalized in the teaching hospital in Białystok, Poland were asked to complete an anonymous survey of 37 questions on general knowledge about ticks and TBD, preventive behaviors towards TBD. Altogether 445 adult participated in the study (344 female/101 male).

Results: As many as 333/445 properly identified a tick. Consulting a healthcare professional to remove a tick is preferred by 197/445 respondents. After removing a tick 296/445 would like to test the arachnid for pathogens, and 62/445 would take an antibiotic. In the ten-point grading scale TBD were recognized as the major health problem (median 8), preceded by cardiovascular diseases (median 9), and cancer (median 10). Only 38/445 respondents received a vaccine to prevent TBD. 129/445 consider vaccinating themselves or their children in the future.

Conclusions/Learning Points: Our study has shown that there are still many myths and misconceptions in public perception of TBD. Minority of respondents considers vaccination to protect themselves, or their children. Therefore there is a need to launch an education campaign to present most effective method of prophylaxis including opportunities for vaccination.

EP065 / #945

Topic: AS02. Public health and epidemiology (only non SARS-CoV2 content) / AS02.a. Population studies and surveillance

FALL AND RISE OF INVASIVE PNEUMOCOCCAL DISEASE AMONG CHILDREN IN GERMANY

E-Posters

E-POSTER VIEWING

Mark Van Der Linden¹, Andreas Itzek¹, Stephanie Perniciaro², Matthias Imöhl¹

¹University Hospital RWTH Aachen, German National Reference Center For Streptococci, Department Of Medical Microbiology, Aachen, Germany, ²Yale School of Public Health, Epidemiology Of Microbial Diseases, New Haven, United States of America

Backgrounds: Infant PCV vaccination was universally recommended in Germany in 2006. In 2009, two higher-valent formulations (PCV10, PCV13) were licensed. Since March 2020, the SARS-CoV-2 pandemic has strongly deregulated daily life. Here, we present data on invasive pneumococcal disease (IPD) cases in the era of conjugate vaccination during a worldwide pandemic.

Methods: IPD in children in Germany has been monitored since 1997. Isolates were serotyped using the Neufeld Quellung reaction.

Results: SARS-CoV-2 reached Germany at the beginning of March 2020. In the period March-December 2020, only 79 IPD cases were reported among children <16 years of age, whereas in the same periods in 2018 and 2019 (pre-pandemic), case numbers were 144 and 170, respectively. However, in March-December 2021, case numbers increased again to 132. This drop seems to be due to social distancing measures, and not to decreased reporting, as reported Group B Streptococcus cases showed no such reduction. When restrictive measures were loosened, and schools and daycare centers were opened again (September 2021), IPD case numbers immediately normalized to pre-pandemic levels. PCV13 serotypes made up 24.3% and 18.2% of cases in the pre-pandemic periods, but only 13.9% in March-December 2020. In March-December 2021, 28.8% of cases had PCV13 serotypes. For PCV15 serotypes, percentages for March-December 2018/2019/2020/2021 were 29.9, 26.5, 17.7 and 31.8, for PCV20 serotypes, 56.9, 52.9, 43.0 and 58.3. The differences were mainly caused by lower numbers of serotype 3 and 22F cases.

Conclusions/Learning Points: The SARS-CoV-2 pandemic has been a strong reducing effect on IPD among children in Germany. Two times fewer cases were observed, most probably caused by reduced respiratory transmission. Interestingly, coverage of current and future vaccine formulations was clearly lower during March-December 2020, when lockdown measures were most stringent.

EP068 / #1467

Topic: AS02. Public health and epidemiology (only non SARS-CoV2 content) / AS02.a. Population studies and surveillance

INFANT VACCINATIONS IN FLANDERS (BELGIUM) BACK ON SCHEDULE AFTER COVID-19 LOCKDOWNS

E-Posters

E-POSTER VIEWING

Laura Willen¹, Mathieu Roelants², Cécile Guérin², Pierre Van Damme¹, Marlou De Kroon², Corinne Vandermeulen², Kirsten Maertens¹

¹University of Antwerp, Centre For The Evaluation Of Vaccination, Vaccine & Infectious Diseases Institute, Antwerp, Belgium, ²KU Leuven, Department Of Public Health And Primary Care, Leuven, Belgium

Backgrounds: In Belgium, vaccination strategies are defined and managed at the regional level. The region of Flanders monitors childhood vaccination coverage through 4-yearly surveys. In 2021, a new survey was performed to assess vaccination coverage in infants. Timeliness of the infant vaccination schedule was also assessed, as they were due for their booster doses shortly after the COVID-19 lockdown (March-May 2020 in Belgium).

Methods: A total of 721 infants (18-24 months) were recruited in 103 Flemish municipalities through a two-stage randomized cluster design. After parental consent, a parent/caregiver of the infant was interviewed at home or through video call. The vaccination history of the child was transcribed from available documents at home and completed using the electronic Flemish vaccination registry and medical records. The coverage of all recommended vaccines in infants and timeliness of all doses was assessed.

Results: The coverage rate for complete vaccination at 18-24 months was high (88.1%), and comparable to the previous survey in 2016 (85.6%, $p=0.16$). During their first year of life (in 2019), 54% of the children started their schedule within one week of the recommended age, slightly better than in 2016 (49%, $p=0.06$). Notably, also booster doses given in their second year (scheduled from May 2020-October 2020) were timely received by 83% of the children at 12 months ($p=0.32$ vs. 2016) and 67% at 15 months ($p<0.001$ vs. 2016) (Figure 1).

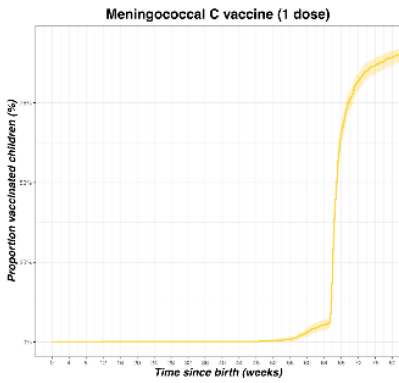
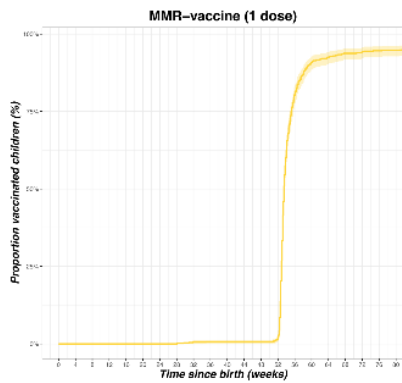
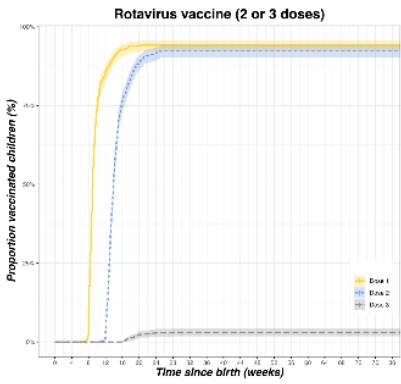
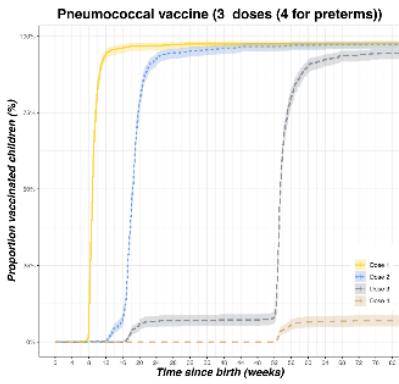
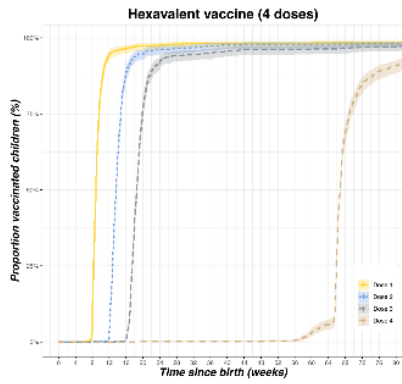

Conclusions/Learning Points: The high overall coverage and the timely administration of infant booster vaccinations scheduled right after the first lockdown suggest a fast recovery of vaccine uptake and we expect a negligible impact of the lockdown on the susceptibility gap created by delayed administration of booster doses in the second year of life.

EP069 / #1420

Topic: AS02. Public health and epidemiology (only non SARS-CoV2 content) / AS02.a. Population studies and surveillance

THE EPIDEMIOLOGY OF SEPTICAEMIA IN CHILDREN AGED 6 TO 15 YEARS IN MALTA AUTHORS: MARIE-CLAIRE ZAMMIT, DAVID PACE

E-Posters

E-POSTER VIEWING

Marie-Claire Zammit

Mater Dei Hospital, Paediatrics, MSD, Malta

Backgrounds: Sepsis in children >5years is less common than in younger age groups, but is important to recognise and treat. We aimed to describe the epidemiology of sepsis in 6- to 15-year-old children in Malta.

Methods: All positive blood cultures in 6-15-year-olds admitted from 1st January 2010 to 31st December 2020 were analysed retrospectively. Incidence rates for invasive isolates were calculated for 6-10-year-old children and 11-15-year-old adolescents. Contaminants and isolates from children with central lines were excluded.

Results: During the 11-year study period there were 19 septic episodes in 6- to 10-year-olds, presenting at a mean age of 8.5 years. The overall annual mean incidence rate of sepsis was 8.5/100,000 children with incidence rates of 4.46 and 3.6/100,000 for Gram-negative and -positive sepsis respectively. Staphylococcus aureus, Pseudomonas aeruginosa, and Escherichia coli and were the most frequent pathogens affecting 2.6, 1.4, and 0.9/100,000 children annually. In the 11- to 15-year-old adolescents, there were 26 septic episodes at a mean age of 13.2 years. The overall mean annual incidence rate of sepsis was 10.8/100,000 individuals of which 5.3 and 5.5/100,000 were Gram-positive and -negative sepsis, respectively. Escherichia coli, Staphylococcus aureus, Streptococcus pneumoniae and Streptococcus pyogenes were the most frequent pathogens with a mean incidence rate of 1.3/100,000 each followed by Pseudomonas aeruginosa and Neisseria meningitidis, with mean incidence rates of 1.2 and 0.8 per 100,000 respectively.

Conclusions/Learning Points: Staph. aureus, E. coli and P. aeruginosa are the most frequent cause of sepsis in 6-15 year old children. In adolescence the pneumococcus, meningococcus and Group A streptococcus also contribute to septic episodes. The empiric antibiotic regimens for children >5 years old and adolescents have to ensure appropriate cover for these pathogens.

EP072 / #582

Topic: AS03. Vaccines (only non SARS-CoV2 content) / AS03.b. Vaccine development (phase 1-2) – bacterial and all non-viral

PUBLIC HEALTH PERSPECTIVE OF A PENTAVALENT MENINGOCOCCAL ABCWY VACCINE COMBINING ANTIGENIC COMPONENTS OF MENACWY-CRM AND 4CMENB VACCINES: PROGRESSING TOWARDS A MENINGOCOCCAL-FREE WORLD

E-Posters

E-POSTER VIEWING

Rafik Bekkat-Berkani¹, Woo-Yun Sohn¹, Elena Fracapane², Rino Rappuoli³

¹GlaxoSmithKline, N/a, Rockville, United States of America, ²GlaxoSmithKline, Clinical Research And Development Centre, Siena, Italy, ³GlaxoSmithKline, N/a, Siena, Italy

Backgrounds: Meningococcal serogroup distribution fluctuates over time across global regions and age groups. Here, we discuss the potential public health impact of a pentavalent MenABCWY vaccine that combines the antigenic components of two established vaccines – MenACWY-CRM (Menveo®) and 4CMenB (Bexsero®), which were developed to help control the spread of meningococcal disease and help improve immunisation rates.

Methods: Established scientific evidence and innovation of combination vaccines over time were reviewed, together with real-world evidence and clinical experience with MenACWY-CRM and 4CMenB. These data were considered in an evaluation of the potential public health impact of a new MenABCWY vaccine.

Results: Direct broad invasive meningococcal disease (IMD) protection of high-risk groups is important for effective routine immunisation programmes. There are potential advantages in combining the most prevalent serogroup antigens in a single vaccine. Since the introduction of combined quadrivalent vaccines, there has been a positive impact demonstrated over time on public health regarding IMD, with a decline in the incidence of combined IMD serogroups and an increase in immunisation rates. Further advances in combination vaccines may improve patient care through broader immune protection and simplification of vaccination schedules, leading to improved convenience, compliance, and immunisation rates. The latest research leading to the development of next-generation meningococcal vaccines, built upon the established evidence of MenACWY-CRM and 4CMenB vaccines, has culminated in the pentavalent MenABCWY vaccine currently under evaluation (NCT04502693), and is expected to contribute to the global control of meningococcal disease.

Conclusions/Learning Points: Despite major improvements, meningococcal disease remains a global public health concern. Pentavalent MenABCWY has the potential to provide significant public health benefits through practical, broad IMD protection programmes encompassing serogroups A, B, C, W and Y.

EP073 / #1803

Topic: *AS03. Vaccines (only non SARS-CoV2 content) / AS03.b. Vaccine development (phase 1-2) – bacterial and all non-viral*

ENHANCING EFFECT OF PNEUMOCOCCAL VACCINE ANTIBODY TITER BY HOCHUEKKITO

E-Posters

E-POSTER VIEWING

Masaaki Minami¹, Toshiaki Makino²

¹Nagoya City University Graduate School of Medical Sciences, Bacteriology, Nagoya, Japan, ²Nagoya City University Graduate School of Pharmaceutical Sciences, Pharmacognosy, Nagoya, Japan

Backgrounds: Invasive pneumococcal disease is serious infection that can cause death in children. Due to the increase in the number of drug-resistant pneumococci, infection control and prevention with pneumococcal vaccines is important. However, it is unclear whether sufficient antibody titer is obtained since antibody testing after vaccination has not been conducted in Japan. Hochuekkito (HET) is a traditional Japanese medicine for fatigue recovery and immune activation. However, the enhancing effect of Hochuekkito on pneumococcal vaccine has been unknown. In this study, we investigated whether HET affect the antibody titer of pneumococcal vaccine in a mouse model.

Methods:: PCV13 was administered intramuscularly to balb/c females 6 weeks old mice on day 0 of the experiment. HET was orally administered to mice from day 0 to day 3, and from day 4 to day 7 of the experiment, respectively. After 14 days of the experiment, blood was collected from euthanized mice. After serum separation, antibody titer in the serum was measured by enzyme-linked immuno sorbent assay (ELISA).

Results: Serum antibody titers increased after PCV13 administration. Serum antibody titers after PCV13 and 0 to 3 days of oral HET were lower than PCV13 alone. However, Serum antibody titers after PCV13 and 4 to 7 days of oral HET were significantly higher than PCV13 alone.

Conclusions/Learning Points: Our experimental results suggest that Hochuekkito may increase the antibody titer caused by PCV13, depending on the timing of administration, thereby enhancing the vaccine efficacy.

EP074 / #1171

Topic: AS03. Vaccines (only non SARS-CoV2 content) / AS03.c. Vaccine efficacy (phase 3) and effectiveness – viral

NEED FOR IMPROVED ROTAVIRUS VACCINATION COVERAGE IN LOW BIRTH WEIGHT INFANTS

E-Posters

E-POSTER VIEWING

Ali Munir, Kyu Bin Oh, Priya Pereira
GSK, Vaccines, Wavre, Belgium

Backgrounds: Rotavirus infection is the most common cause of severe diarrhea in <5-year-olds. If infected, low birth weight (LBW; <2,500 g) infants are at higher risk of severe disease/complications/hospitalizations/death than normal birth weight (NBW) infants. Although health organizations recommend infant routine rotavirus vaccination (including for clinically stable preterm infants who fulfill chronological age requirements), gaps in vaccination timelines and completeness were observed. We performed a systematic literature review of data on safety/efficacy/effectiveness/impact/compliance/coverage of rotavirus vaccination in high-risk infants, including LBW ones. Here we summarize data on rotavirus vaccine safety, effectiveness and use in LBW infants in community and hospital/neonatal intensive care unit.

Methods: In the systematic literature review (PROSPERO CRD42020199926) we searched for high-risk infant data published between 1995-2020[August] in PubMed/Embase/Cochrane Library, congress/society abstract databases, clinical trials databases, PROSPERO and relevant organization websites. Data were extracted using a standardized form and were double-checked by another reviewer. Additional search was conducted for LBW infant data published between 2020[August]-2021[September] in PubMed.

Results: Five of 2,340 screened articles were included in this review. In LBW infants, rotavirus vaccination was well tolerated, led to 93-98% reduction in rotavirus hospitalization rates (post-vaccine versus pre-vaccine introduction), and to 71-72% reduction in acute gastroenteritis hospitalization rates (comparing vaccinated versus unvaccinated LBW infants), yet vaccination was significantly delayed, and coverage/completion rates were lower than in NBW infants (Table) due to age restrictions and various concerns.

Table. Summary of review results for rotavirus vaccination in low birth weight (LBW) infants (reference, study participants and country, efficacy, effectiveness, impact, safety, compliance with or coverage)

| Publication | Study participants and country | Safety | Efficacy, effectiveness, impact | Compliance with or coverage of rotavirus vaccination |
|---|--|--|---|---|
| Stumpf et al. <i>Pediatrics</i> 2013;132:e662-5 | 213 VLBW ($\leq 1,500$ g) infants were discharged from neonatal intensive care unit at Parkland Memorial Hospital, Texas, US, between May-2008 and April-2010. Of these, 31% were extremely LBW (ELBW; $< 1,000$ g) infants. | No complications in 4 infants vaccinated at > 104 days of age, i.e., older than the recommended age limit. 9 additional infants who had a previous diagnosis of necrotizing enterocolitis were vaccinated at the time of discharge. All tolerated the vaccine without ill effects, and none had intussusception reported on follow-up. | not available | - 63% of the 213 VLBW infants did not receive rotavirus vaccine at discharge. - 48 (23% of the 213 VLBW) infants were too old for vaccination at the time of discharge. |
| Ochoa et al. <i>Vaccine</i> 2015;33:354-8 | 222 infants in Lima, Peru, were enrolled. 41 VLBW ($< 1,000$ g) and 157 LBW (1,000-1,500 g) infants were included in the study and completed the follow-up. | not available | not available | - VLBW infants: 56.1% received dose 1 and 51.2% received dose 2. - LBW infants: 79.0% received dose 1 and 65.0% received dose 2. - 61.6% of infants received 2 doses of rotavirus vaccine by 9 months of age. |
| Mrozek-Budzyn et al. <i>Arch Med Sci</i> 2016;12:614-20 | Poland: 303 children who received the complete rotavirus vaccination course, and 303 children unvaccinated against rotavirus. Of these, 14 were LBW ($< 2,500$ g) children unvaccinated, and 10 were LBW children vaccinated against rotavirus. | not available | - 96 (15.8% of all 606) children had winter-spring gastrointestinal infections. Cumulative incidence of winter-spring gastrointestinal infections in first 5 years of life was 20.8% (unvaccinated children) and 10.9% (rotavirus vaccinated children). - Birth weight $< 2,500$ g increased risk of infection twice and reached statistical significance ($p=0.044$). - Effect of rotavirus vaccine not significant only for the 1 st year of life (vaccine effectiveness: 32.9% in 1 st year of life; 44.3% in the first 5 years of life). - Overall, rotavirus vaccine had a significant protective effect. | not available |
| Dahl et al. <i>Pediatr Infect Dis J.</i> 2018;37:817-22 | Approximately 2 million US children < 5 years of age between July-2001 and June-2015 were included. Of them, 4% were LBW ($< 2,500$ g) infants; among LBW ones, 24% were very LBW (VLBW; $< 1,500$ g) infants. | not available | - For 2014-2015, among < 5 -year-olds, Acute gastroenteritis (AGE) hospitalization rate reductions versus pre-vaccine introduction (2001-2006): 64% (LBW) and 55% (VLBW). - Rotavirus hospitalization rate reductions: 98% (LBW) and 93% (VLBW). Among 3-23-month-olds, rotavirus vaccines resulted in a 72% (LBW) and 71% (VLBW) reduction in AGE hospitalization rates comparing vaccinated versus unvaccinated children. | - As of December-2014, coverage among infants who had received ≥ 1 dose of rotavirus vaccine was 82% (LBW) and 64% (VLBW). - The difference in rotavirus vaccine coverage among the LBW and normal birth weight (NBW) infants was statistically significant ($p<0.0001$). |
| Bary-Weisberg, Stein-Zamir. <i>Hum Vaccin Immunother.</i> 2021;17:1666-74 | 13,315 LBW (1,000-2,499 g) infants and 580 VLBW ($< 1,000$ g) infants born in Israel in 2016 (from 01 January until 31 December) | not available | not available | - LBW infants showed delayed initiation of vaccination compared to NBW infants; odds ratio for delaying initiation of rotavirus vaccination was 1.22 (95% confidence interval: 1.16-1.29). - Vaccination delay rates increased with decreasing birthweight. |

Conclusions/Learning Points: Although immunization of LBW infants with rotavirus vaccine had an acceptable safety profile and was effective, coverage/completion rates were low in this group. High-quality data on rotavirus vaccination in LBW infants is limited and should be interpreted cautiously. Further research is warranted to develop strategies to protect LBW infants against rotavirus infection. Funding: GlaxoSmithKline Biologicals SA

EP076 / #843

Topic: AS03. Vaccines (only non SARS-CoV2 content) / AS03.d. Vaccine efficacy (phase 3) and effectiveness – bacterial and all non-viral

CLINICAL EFFECTIVENESS OF 13-VALENT CONJUGATED PNEUMOCOCCAL VACCINE AGAINST SEVERE PNEUMONIA IN PANAMANIAN CHILDREN: A MATCHED CASE-CONTROL STUDY

E-Posters

E-POSTER VIEWING

Jacqueline Levy¹, Rodrigo Deantonio², Xavier Sáez Llorens³

¹Hospital del Niño doctor Jose Renan Esquivel, Medicina/infectología, Panama, Panama, ²CEVAXIN, Dirección, Panama, Panama, ³Hospital del Niño doctor Jose Renan Esquivel, Investigación, Panama, Panama

Backgrounds: In Panama, the 13-valent pneumococcal conjugate vaccine (PCV13) was included in late 2010 with a 3-dose schedule. We evaluated the effectiveness of PCV13 against severe community acquired pneumonia (CAP) in children between 2 and 59 months in the Republic of Panama, after its introduction into the national immunization program.

Methods: A retrospective matched case-control study was conducted at Hospital del Niño Doctor José Renán Esquivel taking data from patients between 2 and 59 months of age in the period subsequent to the introduction of the PCV13 vaccine (2013 - 2015). Cases of severe CAP had radiographically confirmed pneumonia (consolidated or with pleural effusion) or pneumonia with “other infiltrate” associated with CRP > 40 mg/L with severity criteria according to the 2013 World Health Organization definition. Controls were children hospitalized for non-immune-preventable diseases matched by age and date of admission of the cases. Vaccine effectiveness was estimated as $(1 - \text{odds ratio}) \times 100\%$ with 95% confidence intervals.

Results: 78 paired cases with 198 controls were included. In the cases the mean age was 13.7 ± 10.3 SD months and the hospital stay 7.7 ± 6.3 days. In general, the vaccine effectiveness of PCV13 against severe CAP was 66.1% (95% CI 44.1-99.1, $p < 0.05$). Vaccine effectiveness was 54.8% (95% CI: 30.3-99.0%) among children less than 1 year old and 78.6% (95% CI: 8.8-99.0%) among older children. For children who had received at least 1 PCV13 dose it was 17.2% (95% CI: 8.8-33.7%). Low weight, overcrowding and the lack of vaccination against influenza, were risk factors for lower vaccine effectiveness.

Conclusions/Learning Points: PCV13 was effective in preventing severe cases of CAP in Panamanian children.

Topic: AS03. Vaccines (only non SARS-CoV2 content) / AS03.d. Vaccine efficacy (phase 3) and effectiveness – bacterial and all non-viral

PHASE 3 STUDY OF SAFETY, TOLERABILITY AND IMMUNOGENICITY OF V114 COMPARED WITH PCV13 IN 2+1 (FULL TERM) AND 3+1 (PRETERM) REGIMENS IN HEALTHY INFANTS (PNEU-PED-EU-1)

E-Posters

E-POSTER VIEWING

Federico Martín-Torres^{1,2}, Jacek Wysocki³, Leszek Szenborn⁴, Alfonso Carmona-Martinez⁵, Airi Poder⁶, Luwy Musey⁷, Kara Bickham⁸, Christopher Gilbert⁹, Marie-Chantale Trudel¹⁰, Sheryl Flores¹¹, Robert Lupinacci¹², Richard Mcfetridge¹³, Qiuxu Chen¹⁴, Han Gerrits¹⁵, Janusz Kaminski¹⁶
¹Hospital Clínico Universitario de Santiago de Compostela, Translational Paediatrics And Infectious Diseases, Paediatrics Department, Santiago de Compostela, Spain, ²University of Santiago de Compostela, Genetics, Vaccines And Paediatrics Research Group, Santiago de Compostela, Spain, ³Poznan University of Medical Sciences, Department Of Preventative Medicine, Poznan, Poland, ⁴Wroclaw Medical University, Department Of Pediatrics And Infectious Diseases, Wroclaw, Poland, ⁵Instituto Hispalense de Pediatría, Pediatric Consultations, Sevilla, Spain, ⁶Tartu University Clinics Foundation, Clinic Of Dermatology, Tartu, Estonia, ⁷Merck & Co., Inc., Vaccine, Clinical Research, Kenilworth, United States of America, ⁸Merck & Co., Inc., Global Clinical Development, Kenilworth, United States of America, ⁹Merck & Co., Inc., Clinical Sciences And Study Management, Kenilworth, United States of America, ¹⁰Merck & Co., Inc., Clinical Sciences And Study Management (cssm), Kenilworth, United States of America, ¹¹Merck & Co., Inc., Global Clinical Trial Operations, Kenilworth, United States of America, ¹²Merck & Co., Inc., Biostatistics And Research Decision Sciences, Kenilworth, United States of America, ¹³Merck & Co., Inc., Mrl, Kenilworth, United States of America, ¹⁴Merck & Co., Inc., Mrl Bards, Kenilworth, United States of America, ¹⁵MSD B.V., Regulatory Affairs Europe, Oss, Netherlands, ¹⁶MSD, European Clinical Development, London, United Kingdom

Backgrounds: Despite widespread use of pneumococcal conjugate vaccines (PCVs) in children, pneumococcal disease caused by non-vaccine serotypes remains a concern. V114 is a 15-valent PCV containing the 13 serotypes in 13-valent PCV (PCV13) plus two additional serotypes (22F and 33F). This study evaluated safety and immunogenicity of V114 compared with PCV13 in healthy infants, and concomitant administration with DTaP/IPV/Hib/HepB and rotavirus vaccines.

Methods: Safety was evaluated as the proportion of participants with adverse events (AEs; Days 1–14 post-vaccination). Serotype-specific anti-pneumococcal immunoglobulin G (IgG) and opsonophagocytic activity (OPA) were measured 30 days post-primary series (post-dose 2 for full-term infants; post-dose 3 for preterm infants), immediately prior to the toddler dose and 30 days post-toddler dose (PTD) of V114 or PCV13 (post-dose 3 for full-term infants; post-dose 4 for preterm infants).

Results: 1184 healthy infants 42–90 days of age were randomised 1:1 to V114 (n=591) or PCV13 (n=593) as a 2+1 (full-term; n=1116) or 3+1 (preterm; n=68) regimen. Proportions of participants with solicited AEs and serious AEs were comparable between vaccination groups. V114 met non-inferiority criteria for all 13 shared serotypes and superiority criteria for serotypes 22F and 33F, as assessed by IgG response rates (Figure 1) and geometric mean concentrations at 30 days PTD. Immune responses elicited by DTaP/IPV/Hib/HepB and rotavirus vaccines administered concomitantly with V114 were non-inferior to those following concomitant administration with PCV13.

Conclusions/Learning Points: In healthy infants, V114 was well tolerated, with a safety profile generally comparable to PCV13. Compared with PCV13, V114 provided non-inferior immune responses to the 13 shared serotypes and superior immune responses to the additional serotypes 22F and

33F.

**Pneumococcal serotype
13 shared serotypes**

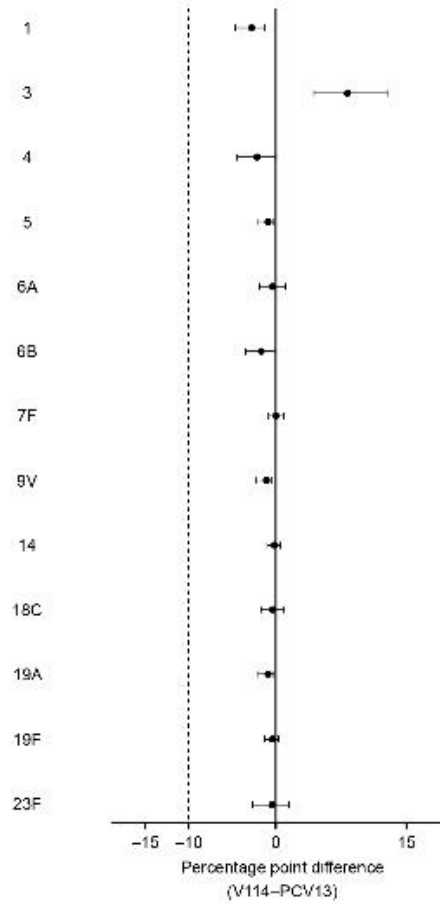

| V114 | | PCV13 | | Difference (95% CI) |
|------|---------|-------|---------|---------------------|
| n | % ≥0.35 | n | % ≥0.35 | |
| 539 | 96.7 | 537 | 99.4 | -2.8 (-4.7, -1.3) |
| 539 | 92.0 | 537 | 83.8 | 8.2 (4.4, 12.2) |
| 539 | 95.7 | 535 | 97.9 | -2.2 (-4.5, -0.1) |
| 539 | 99.1 | 535 | 100.0 | -0.9 (-2.2, -0.2) |
| 539 | 96.5 | 535 | 98.9 | -0.4 (-1.9, 1.1) |
| 539 | 97.4 | 535 | 99.1 | -1.7 (-3.5, -0.1) |
| 539 | 99.8 | 536 | 99.8 | 0.0 (-0.9, 0.9) |
| 539 | 96.9 | 537 | 100.0 | -1.1 (-2.4, -0.4) |
| 539 | 99.8 | 537 | 100.0 | -0.2 (-1.0, 0.5) |
| 539 | 98.9 | 536 | 99.3 | -0.4 (-1.8, 0.9) |
| 539 | 99.1 | 535 | 100.0 | -0.9 (-2.2, -0.2) |
| 539 | 99.8 | 537 | 100.0 | -0.4 (-1.3, 0.3) |
| 538 | 96.8 | 535 | 97.4 | -0.5 (-2.7, 1.5) |

**2 serotypes
unique to V114**

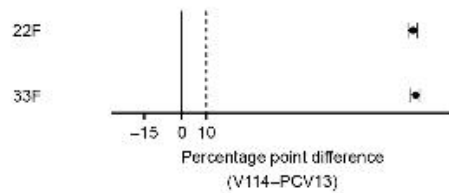

| V114 | | PCV13 | | Difference (95% CI) |
|------|---------|-------|---------|---------------------|
| n | % ≥0.35 | n | % ≥0.35 | |
| 539 | 99.8 | 535 | 5.8 | 93.8 (91.5, 95.6) |
| 539 | 99.1 | 530 | 4.2 | 94.9 (92.7, 96.5) |

EP078 / #1381

Topic: AS03. Vaccines (only non SARS-CoV2 content) / AS03.d. Vaccine efficacy (phase 3) and effectiveness – bacterial and all non-viral

VACCINE-INDUCED ANTIBODY RESPONSES TO PERTUSSIS DETECTED IN THE UPPER AIRWAY OF GAMBIAN INFANTS

E-Posters

E-POSTER VIEWING

Anja Saso^{1,2}, Haddijatou Jobe², Evi Schuppen^{3,4}, Aru-Kumbah Baldeh², Modou Fofana², Karamo Conteh², Mike Okoye², Ebrima Kanteh², Philip Mendy², Sarjo Sanneh², Thushan De Silva^{1,2,5}, Sophie Roetynck^{1,2}, Dimitri Diavatopoulos^{3,4}, Beate Kampmann^{1,2}

¹London School of Hygiene & Tropical Medicine, Faculty Of Infectious And Tropical Diseases, London, United Kingdom, ²MRC Unit The Gambia, Vaccines & Immunity Theme, Banjul, Gambia, ³Radboud Institute for Molecular Life Sciences, Section Paediatric Infectious Diseases, Laboratory Of Medical Immunology, Nijmegen, Netherlands, ⁴Radboudumc, Radboud Centre For Infectious Diseases, Nijmegen, Netherlands, ⁵University of Sheffield, The Florey Institute For Host-pathogen Interactions And Department Of Infection, Immunity And Cardiovascular Disease, Sheffield, United Kingdom

Backgrounds: Replacement of whole-cell (wP) by acellular pertussis (aP) vaccines may be a key factor underlying the recent resurgence in pertussis, even in highly vaccinated populations. Both vaccines prevent severe disease. aP vaccines, however, fail to protect against nasal colonisation and/or transmission in animal models, although there is minimal data in humans. Our study aims to characterise differences between aP versus wP vaccine-induced T-cell and antibody responses in the nasal mucosa.

Methods: Our project is nested within the Gambian Pertussis Study (GaPs), a blinded randomised-controlled trial investigating the immunogenicity of infant aP versus wP vaccines, and the impact of maternal immunisation in The Gambia. Using a novel non-invasive absorption device, fluid produced by nasal mucosal lining is collected from infants up to 9-months of age, at maximum 5 time points pre-and post-completion of primary immunisation. Samples are immediately eluted and frozen at -80C. Functional pertussis-specific antibodies are being measured using an optimised opsonisation assay.

Results: Our pilot results on 10 infants demonstrate the feasibility of collecting and eluting mucosal fluid samples in The Gambia. The presence of pertussis-specific functional antibody was confirmed in infants' upper airway with possible clustering of pertussis-specific antibody responses according to infant and/or maternal pertussis vaccination background.

Conclusions/Learning Points: This is the first study of its kind in an infant cohort in any Sub-Saharan African setting. Our preliminary results are promising although further data from up to 100 infants are awaited in early 2022 and comprehensive analysis requires completion of the trial with unblinding. Our findings are being correlated with data on pertussis colonisation and systemic immunity. Broadly, they will inform the design and testing of the next-generation of pertussis vaccines, with improved impact on infection and transmission, and potentially delivered intramucosally.

EP079 / #1126

Topic: AS03. Vaccines (only non SARS-CoV2 content) / AS03.e. Vaccine safety (post licensure)

COMBINED MEASLES-MUMPS-RUBELLA-VARICELLA VACCINE AND FEBRILE CONVULSIONS: THE RISK CONSIDERED IN THE BROAD CONTEXT

E-Posters

E-POSTER VIEWING

Giacomo Casabona¹, Olivia Berton¹, Markus Knuf², Paolo Bonanni³

¹GSK, Vaccines, Wavre, Belgium, ²Klinikum Worms, Klinik Für Kinder- Und Jugendmedizin, Worms, Germany, ³University of Florence, Health Sciences, Florence, Italy

Backgrounds: Compared to co-administration of separate measles-mumps-rubella and varicella vaccines (MMR+V), the combined measles-mumps-rubella-varicella vaccine (MMRV) offers benefits such as reduced number of injections and frequency of local adverse events, potentially improving compliance with vaccination. Due to a slight increase in the relative risk of febrile convulsion (FC) observed in measles-naïve children post-first MMRV dose, some national authorities have changed their recommendations to favor MMR+V as a first dose. We aimed to reconsider the risk of FC post-first MMRV dose in a broader context and to identify a possible risk minimization approach.

Methods: We reviewed publications on FC post-first dose of MMRV versus MMR+V and reassessed its risk in the overall context of common clinical practice, thereby summarizing information on the real risk. Based on this reassessment, we outlined potential actions for risk minimization.

Results: Available data indicate that the safety profile of MMRV might be comparable with that of MMR/MMR+V. While present, the risk of FC post-first MMRV dose is very low versus the overall risk due to other causes of FC and is not further increased when MMRV is co-administered with other pediatric vaccines. Children at high risk of convulsions (especially those with personal/family history) are more prone to FC after any vaccination. In a post-hoc analysis of a matched cohort study, modelled FC incidence post-first dose was similar in children without personal/family history receiving MMRV and the whole cohort receiving MMR/MMR+V.

Conclusions/Learning Points: The balance between the risk and advantages of the first MMRV dose can be considered positive when assessed in a broader context. The increased risk of FC post-MMRV might be mitigated by limiting administration of first MMRV dose to children without personal/family history of FC. Funding: GlaxoSmithKline Biologicals SA

EP080 / #1843

Topic: AS03. Vaccines (only non SARS-CoV2 content) / AS03.e. Vaccine safety (post licensure)

POST-VACCINATION SEIZURES IN CHILDREN WITH DRAVET SYNDROME: CAN THEY BE PREVENTED?

E-Posters

E-POSTER VIEWING

Lucy Deng¹, Nicholas Wood¹, Margie Danchin², Ingrid Scheffer³

¹Children's Hospital at Westmead, National Centre For Immunisation Research And Surveillance, Westmead, Australia, ²Royal Children's Hospital, Murdoch Children's Research Institute, Melbourne, Australia, ³The University of Melbourne, Epilepsy Research Centre, Melbourne, Australia

Backgrounds: One third of children with Dravet syndrome have seizures triggered by vaccination. In children with Dravet syndrome and previous vaccine proximate seizures (VPS), we aimed to establish whether prophylactic benzodiazepine use prevented further seizures following vaccination.

Methods:: In this retrospective multicentre cohort study, we analysed the course of children with Dravet syndrome and previous VPS who presented to a Specialist Immunisation Clinic at one of four Australian tertiary paediatric hospitals between 2013-2017 for management of further vaccination. Clinical history, vaccination management and outcomes were obtained from medical records. We compared the clinical management of patients who did and did not experience further VPS within 14 days of vaccination.

Results: We identified 18 children with Dravet syndrome who had a previous VPS; for 11/18 (58%) children, the VPS was their first seizure. Of the 18 children, 16 had further vaccination encounter(s) (46 encounters, median 3 encounters/child). There were 12 recurrent VPS in 11/16 (69%) children, with one child having two further VPS; all 12 were afebrile seizures of which 7 (58%) were afebrile status epilepticus. VPS recurrence did not differ by age at revaccination (range: 6-62 months) or revaccination setting (outpatient, day stay or inpatient). Prophylactic benzodiazepine (clobazam/clonazepam) use occurred in 26/46 (57%) of vaccination encounters and was associated with lower VPS recurrence (odds ratio OR 0.033 (95%CI 0.004-0.291), P<0.01).

Conclusions/Learning Points: Two-thirds of children with Dravet syndrome who have an initial VPS experienced recurrent VPS, most frequently comprising life-threatening episodes of afebrile status epilepticus. As prophylactic post-vaccination use of a benzodiazepine lowered the likelihood of VPS recurrence by 30 fold, benzodiazepine administration in the at-risk post-vaccination period should be routinely implemented into vaccination management in children with confirmed or even suspected Dravet syndrome.

EP081 / #867

Topic: AS03. Vaccines (only non SARS-CoV2 content) / AS03.e. Vaccine safety (post licensure)

PENTAVALENT AND HEXAVALENT DIPHTHERIA-TETANUS-PERTUSSIS VACCINATION IS IMMUNOGENIC AND HAS AN ACCEPTABLE SAFETY PROFILE IN PRETERM INFANTS

E-Posters

E-POSTER VIEWING

Markus Knuf¹, Lauren Mason², Petra Köbrunner², Valérie Berlaimont³

¹Klinikum Worms, Klinik Für Kinder- Und Jugendmedizin, Worms, Germany, ²Pallas Health Research and Consultancy, Pallas Health Research And Consultancy, Rotterdam, Netherlands, ³GSK, Gsk Vaccine, Wavre, Belgium

Backgrounds: Newborns, particularly if born prematurely or having special conditions, are at increased risk of vaccine-preventable diseases. We aimed to review data on infants with special conditions vaccinated with diphtheria-tetanus-pertussis (DTP) pentavalent and/or DTP hexavalent vaccines.

Methods: We conducted a systematic literature search in PubMed and Embase to identify data on DTP pentavalent and/or hexavalent vaccination of infants with special conditions, including very/moderate preterm infants (V/MPT, ≤ 33 weeks of gestation or < 1500 g [very low birth weight (VLBW)]). All published studies referring to DTP pentavalent and/or hexavalent vaccines administered alone or co-administered in V/MPT or infants with special conditions were included. Studies covering other vaccinations and healthy DTP-vaccinated infants were excluded. We extracted data on vaccine immunogenicity (post-primary, post-booster), reactogenicity/safety and compliance with vaccination schedule.

Results: We identified 980 unique references (963: database search; 17: other sources). After title/abstract and full-text screening, 15 studies were selected, 14 provided data on V/MPT and are discussed here. In 6 studies presenting immunogenicity, at 1 month post-vaccination, seropositivity rates were similar in V/MPT and full-term infants for most of the DTP vaccine antigens. Lower antibody levels in V/MPT were inconsistently reported for some antigens (Table). Pain and irritability were the most reported solicited adverse events in V/MPT. Apnoea, bradycardia and desaturation occurring in V/MPT vaccinated with DTP were reported in 4 of the 8 studies presenting reactogenicity/safety data. The majority of VPT and VLBW were vaccinated with delay in 4 of 5 compliance data studies.

Conclusions/Learning Points: DTP vaccines used for V/MPT vaccination vary widely. However, in our analysis, one hexavalent vaccine provided most of the immunogenicity data (Table). DTP pentavalent/hexavalent vaccines proved to be immunogenic and with acceptable safety profile when administered in V/MPT.

Table. Studies on preterm infants presenting immunogenicity data

| Reference | Country, Study design | Study vaccine, Co-administration, HBV birth dose | Study population: case definition | Dose, time point | Overall immunogenicity conclusions in very/moderate preterm infants (V/MPT) |
|--|---|--|--|---|---|
| Klein, <i>J Infect Dis</i> 2010 | United States, Open-label prospective study | • DTaP-IPV-HBV • Co-administration: pneumococcal and Hib vaccines • HBV birth dose: NR | Preterm: <33 weeks Full-term: ≥37 weeks | Post-primary, 1 month after 3rd dose | • Seroconversion for all 3 poliovirus serotypes for V/MPT • Significantly lower GMT to poliovirus type 1 for V/MPT • No significant differences in GMTs to poliovirus types 2 and 3 between V/MPT and full-term groups |
| Kulkarni-Munjo, <i>Front Immunol</i> 2021 | India, Prospective observational study | • DTwP-HBV-Hib • Co-administration: NR • HBV birth dose: Infants weighing >2000 g | Preterm: 28–32 weeks Full-term: >36 weeks | Post-primary, 1 month after 3rd dose | • Adequate antibody response and 100% seroconversion for tetanus and diphtheria for all VPT • Lower antibody levels for Hib and HBV, with ~8% of VPT lacking protective levels of anti-HBV antibodies • Suboptimal response to pertussis in all infants |
| Omeñaca, <i>Pediatr Inf Dis J</i> 2011 | Spain, Phase III open, controlled study | • D1aP-HepB-IPV • Co-administration: Hib-meningococcal and pneumococcal vaccine; ORV was permitted at any time • HBV birth dose: 2 infants | Preterm: <31 weeks Full-term: >36 weeks | Post-primary, 1 month after 3rd dose | • 97.5% (ns) of VPT had reached 10 mIU/ml cut-off for HBV • There was no significant difference between proportion of VPT and full-term infants reaching either ≥10 mIU/ml or ≥100 mIU/ml cut-offs for HBV • After primary vaccination, anti-HBV GMCs were significantly lower and persisted at lower values until 16–18 months of age in the VPT group compared to the full-term group |
| Omeñaca, <i>Pediatrics</i> 2011 | Spain and Greece, Prospective observational study | • Primary: DTaP-HBV-IPV/Hib | Preterm: 27–30 weeks Full-term: >36 weeks | Post-primary, 1 month after primary vaccination, Post-booster, 1 month after booster dose | • One month after primary vaccination, all but 1 VPT (~9%, with no seroconversion against poliovirus type 3) were seropositive against all antigens |
| | | • Booster: DTaP-IPV/Hib | | | • One month after booster vaccination, all infants were seropositive against all antigens |
| | | • Co-administration: 3-dose primary + booster pneumococcal vaccine • HBV birth dose: NR | | | • Overall, antibody GMCs/GMTs were within the same ranges across groups and in line with previous experience with these DTPa-based combination vaccines when administered separately |
| Omeñaca, <i>Infect Dis Obstet Gynecol</i> 2010 | Spain, Open-label study | • DTaP-HBV-IPV/Hib • Co-administration: NR • HBV birth dose: NR | Preterm groups: • 31–33 weeks • 28–30 weeks • 24–27 weeks • ≥1000 and <1500g • <1000g Full-term: ≥37 weeks | Post-primary, 1 month after 3rd dose Post-booster, 1 month after booster dose | • V/MPT group responded well immunologically and similarly to infants born at full-term • Overall, seropositivity rates were not influenced either by gestational age or birth weight • Lower HBV seroprotection rate in V/MPT group: 31–33 weeks (post-primary: 83.3%; post-booster: 78.3%, ns). Six VPT infants (6.59%) did not respond to primary HBV immunisation and also failed to respond to the booster dose. |
| Vazquez, <i>Acta Pediatr</i> 2008 | Country NR, Open-label study | • D1Pa-HBV-IPV/Hib • Co-administration: NR • HBV birth dose: NR | Preterm groups: • 24–36 weeks and <1500g (VLBW) • 24–36 weeks and 1500–2000g (LBW) | Post-primary, 1 month after 3rd dose Post-booster, 1 month after booster dose | • Seroconversion or vaccine response rates to all antigens were similar between VLBW and LBW groups with no significant differences • Lower anti-HBV antibody concentrations ≥10 mIU/ml (post-primary: 93.7% in VLBW; 94.9% in LBW; post-booster: 88.7% in VLBW; 96.5% in LBW; ns) and anti-PRP antibody concentrations ≥1.0 µg/ml (post-primary: 65.4% in VLBW; 80.8% in LBW) |

■ DTP pentavalent vaccines; ■ DTP hexavalent vaccine. **DTaP-IPV-HBV**, pentavalent diphtheria-tetanus-acellular pertussis-inactivated poliovirus-hepatitis B (Pediarix, GSK); **NR**, not reported; **GMT**, geometric mean titer; **DTwP-HBV-Hib**, pentavalent diphtheria-tetanus-whole pertussis-hepatitis B-*Haemophilus influenzae* type b (Biological E Ltd., India); **DTaP-HepB-IPV**, pentavalent diphtheria-tetanus-acellular pertussis-hepatitis B-inactivated poliovirus (Infanrix penta, GSK); **ORV**, oral rotavirus vaccine; **ns**, no statistical significance; **GMC**, geometric mean concentration; **DTaP-HBV-IPV/Hib**, hexavalent diphtheria-tetanus-acellular pertussis-hepatitis B-inactivated poliovirus-*H. influenzae* type b (Infanrix hexa, GSK); **DTaP-IPV/Hib**, pentavalent diphtheria-tetanus-acellular pertussis-inactivated poliovirus-*H. influenzae* type b (Infanrix quinta, GSK); **VLBW**, very low birth weight; **LBW**, low birth weight.

Funding: GlaxoSmithKline Biologicals SA

EP082 / #1231

Topic: AS03. Vaccines (only non SARS-CoV2 content) / AS03.e. Vaccine safety (post licensure)

REDUCED REACTOGENICITY OF PRIMARY VACCINATION WITH DT3AP-HBV-IPV/HIB COMPARED WITH DT2AP-HBV-IPV-HIB AMONG INFANTS: MATHEMATICAL PROJECTIONS IN FOUR EUROPEAN COUNTRIES

E-Posters

E-POSTER VIEWING

Marina George¹, Jaime Perez-Martin², Kinga Meszaros³, Yara Ruiz Garcia⁴, Valérie Berlaimont⁵





¹hari thrivikramji C/O GSK, Value Evidence & Outcomes, Great Manchester, United Kingdom, ²Murcia Health Council, Public Health Directorate, Murcia, Spain, ³GSK, Value Evidence & Outcomes, Wavre, Belgium, ⁴GSK, Medical Affairs, Madrid, Spain, ⁵GSK, Medical Affairs, Wavre, Belgium

Backgrounds: Mukherjee et al.'s (2021) meta-analysis on adverse reactions (ARs) based on head-to-head studies of hexavalent vaccines showed that primary vaccination in infants with DT3aP-HBV-IPV/Hib vaccine had a lower risk of developing most solicited local and systemic ARs compared to DT2aP-HBV-IPV-Hib. A mathematical projection tool was developed to simulate a hypothetical situation comparing the ARs when applying similar conditions to the two vaccines in national immunization programs (NIPs) in Austria, Czechia, France, and Spain.

Methods: In this scenario, the absolute risk reduction (ARR,%) was calculated to generate the ARs averted when vaccinating with DT3aP-HBV-IPV/Hib compared to DT2aP-HBV-IPV-Hib. The estimated number of ARs per vaccine type was derived from the most recent country-specific primary vaccination coverage applied to the under one-year population projections for 2020.

Results: The calculated ARRs by type: Fever (10.0%), persistent crying (5.0%), anorexia (4.0%), drowsiness (4.0%), irritability (4.0%), and at injection site: Redness (7.0%), pain (6.0%), swelling (3.0%). Modelling results show fever cases attributed to DT3aP-HBV-IPV/Hib and DT2aP-HBV-IPV-Hib were 34,363 and 41,522 (Austria), 54,686 and 66,079 (Czechia), 300,311 and 362,875 (France), 165,672 and 200,186 (Spain). Corresponding redness cases were 35,795 and 40,806 (Austria), 56,965 and 64,939 (Czechia), 312,824 and 356,619 (France), 172,575 and 196,735 (Spain). Fever and redness at injection site were the ARs most frequently avoided when vaccinating with DT3aP-HBV-IPV/Hib compared to DT2aP-HBV-IPV-Hib

NIP characteristics applied and results of the mathematical projections across countries for vaccinating with DT3aP-HBV-IPV/Hib compared to vaccinating with DT2aP-HBV-IPV/Hib

| | Austria | Czechia | France | Spain |
|---|---|---|---|---|
| Latest known primary vaccination coverage (%) among infants | 85.0% ¹  | 97.0% ²  | 90.5% ³  | 97.5% ⁴  |
| Estimation of infants vaccinated in 2020, n | 71,590 | 113,929 | 625,648 | 345,149 |
| Averted adverse reaction ⁵ , any grade, n* | 30,780 | 48,986 | 269,023 | 148,408 |
| Systemic | | | | |
| Fever | 7,159 | 11,392 | 62,564 | 34,514 |
| Persistent crying | 3,579 | 5,696 | 31,282 | 17,257 |
| Anorexia | 2,863 | 4,557 | 25,025 | 13,805 |
| Drowsiness | 2,863 | 4,557 | 25,025 | 13,805 |
| Irritability | 2,863 | 4,557 | 25,025 | 13,805 |
| At injection site | | | | |
| Redness | 5,011 | 7,975 | 43,795 | 24,160 |
| Pain | 4,295 | 6,835 | 37,538 | 20,708 |
| Swelling | 2,147 | 3,417 | 18,769 | 10,354 |

¹World Health Organization, 2021 (Vaccine coverage for DTP3 (third dose of DTP vaccine) in the year 2019 has been used for Austria).

²World Health Organization, 2021 (Vaccine coverage for DTP3 (third dose of DTP vaccine) in the year 2019 has been used for Czechia).

³Bulletin de Santé Publique, 2021 (vaccine coverage for Hexavalent vaccine in the year 2020 has been used for France).

⁴Ministerio de Sanidad, 2021 (Vaccine coverage for Poliomyelitis, DTPa, and Hib. Data from the 2018 cohort have been used for Spain).

⁵Including vomiting, at injection site reactions Grade 3, and systemic reactions Grade 3, the total number of AR studied in the comparative trials were 11. However, three are not displayed in the figure: vomiting because it was not significantly different (95% CI) between the two vaccines, and injection site reactions Grade 3 and systemic AR Grade 3 because it is not for a specific AR.

*one-way sensitivity analyses were conducted for all types of ARs averted.

Conclusions/Learning Points: These findings are limited by the assumptions made per country and lack of ARs stratifications by severity grade. In this hypothetical scenario, the estimated numbers of ARs following primary series hexavalent vaccination in these European countries suggest that vaccination with DT3aP-HBV-IPV/Hib could lead to less ARs compared to DT2aP-HBV-IPV-Hib in NIPs. Further analysis of the impact on healthcare resource utilization may improve present findings interpretation.

EP083 / #621

Topic: AS03. Vaccines (only non SARS-CoV2 content) / AS03.e. Vaccine safety (post licensure)

SAFETY AND IMMUNOGENICITY OF CO-ADMINISTERED MENINGOCOCCAL SEROGROUP B VACCINE (4CMENB) AND USE OF PROPHYLACTIC PARACETAMOL IN INFANTS AND TODDLERS: A LITERATURE REVIEW

E-Posters

E-POSTER VIEWING

Nevena Vicic¹, Véronique Abitbol², Rafik Bekkat-Berkani¹, Pavitra Keshavan³, [Lamine Soumahoro](#)⁴, Daniela Toneatto³

¹GlaxoSmithKline, N/a, Rockville, United States of America, ²GlaxoSmithKline, Global Medical Affairs, Rueil-Malmaison, France, ³GlaxoSmithKline, N/a, Siena, Italy, ⁴GlaxoSmithKline, N/a, Wavre, Belgium

Backgrounds: Co-administering 4CMenB with other childhood vaccines may improve vaccine uptake. We conducted a literature review of published immunogenicity and reactogenicity data related to 4CMenB vaccine co-administration in infants and toddlers, as well as published data on prophylactic paracetamol since 4CMenB licensure.

Methods: The non-systematic literature review was conducted in October 2021 (no specified timeframe) using PubMed. Search terms were 4CMenB, co-administration and associated terms.

Results: Available evidence suggests that co-administration of 4CMenB with recommended routine childhood vaccines has no clinically significant effects on immunogenicity. In two phase 3 studies (N=3,630), 4CMenB (primary schedule or booster dose) did not impair immune responses when co-administered with DTaP-IPV-HBV/Hib vaccines in infants aged 2, 4 and 6 months, or the MMRV vaccine in toddlers aged 12 months (Vesikari, 2013). The safety profile of 4CMenB co-administration with other childhood vaccines was demonstrated by a real-world study of 107,231 infants and toddlers aged 1–18 months within the routine UK immunisation programme (93% of 4CMenB immunisations co-administered with other childhood vaccines [5-in-1, PCV13, rotavirus, Hib, MenC and MMR vaccines]; Hall, 2021). Five studies reported higher rates of fever in infants and toddlers when 4CMenB was co-administered with other childhood vaccines compared with administration of other vaccines alone. Two studies demonstrated the effectiveness of prophylactic paracetamol for reducing the rate of fever in infants without affecting the immune response; prophylactic paracetamol is recommended by the UK Joint Committee on Vaccination and Immunisation.

Conclusions/Learning Points: Available real-world evidence supports the continuation of co-administration of 4CMenB with other childhood vaccines. The evidence suggests that there are no clinically significant effects on immunogenicity of 4CMenB or the co-administered vaccines and transient reactogenicity (fever) that can be managed with prophylactic paracetamol.

EP084 / #522

Topic: AS03. Vaccines (only non SARS-CoV2 content) / AS03.f. Vaccine hesitancy

CHANGES IN CHILDHOOD IMMUNIZATIONS AND INTERMITTENT PREVENTIVE MALARIA TREATMENT IN A PERIPHERAL, REFERRAL IMMUNIZATION CENTER DURING THE FIRST TWELVE MONTHS OF COVID-19 PANDEMIC IN SIERRA LEONE, WESTERN AFRICA

E-Posters

E-POSTER VIEWING

Danilo Buonsenso

Fondazione Policlinico Universitario A. Gemelli IRCCS, Pediatrics, Roma, Italy

Backgrounds: There is increasing evidence that the COVID-19 pandemic disrupted childhood immunization services. However, detailed reports on immunizations and preventive antimalarial prophylactic treatments delivered and how the trends changed in referral centers in low-income countries are still missing.

Methods: We performed a retrospective cross-sectional study. Data for vaccinations administered to children <5 years of age, according to the local vaccination schedule, were extracted from the official records of the Kent Community Health Post, Sierra Leone, in the period between April 2019 and March 2021. We compared the vaccinations performed in the first year, considered as a pre-Covid period, with the second year, post-Covid period. Both the period were then divided in four trimester each and the same analysis was operated for each trimester.

Results: 7283 vaccinations were administered: 4641 in the period between April 2019 and March 2020 and 2642 between April 2020 and March 2021. The drop in immunizations performed began as soon as the first cases were described in China. The drops were statistically significant when the first three trimesters of the two study periods were compared, while no statistically significant differences were observed for all the vaccines performed in the 4th trimesters. Vaccines administered at birth (BGC) were less affected compared to booster vaccinations.

Conclusions/Learning Points: Immunizations administered in a referral health center in Sierra Leone significantly declined during the pandemic. Although the decline was less pronounced in the last months of the pandemic, we don't think that the small increase would indicate the recovery of previously missed vaccinations. These findings open new public health challenges for the coming years.

EP085 / #1092

Topic: AS03. Vaccines (only non SARS-CoV2 content) / AS03.f. Vaccine hesitancy

DECAY OF BORDETELLA PERTUSSIS IMMUNITY IN WOMEN OF CHILDBEARING AGE FOLLOWING COVID-19 NON-PHARMACEUTICAL MEASURES

E-Posters

E-POSTER VIEWING

Frederic Reicherz, Pascal Lavoie, Bahaa Abu-Raya
University of British Columbia, Pediatrics, Vancouver, Canada

Backgrounds: Young infants are at high risk for severe pertussis morbidity and mortality leading to the recommendation of immunization against pertussis in pregnancy. Recent studies have reported a near disappearance of respiratory pathogens including *Bordetella pertussis* following the implementation of mitigation strategies to control Coronavirus disease 2019 (COVID-19). We aimed to explore how immunity against *B. pertussis* changed in women of childbearing age in the context of limited bacterial population exposure.

Methods: Paired blood samples were collected from female health care workers of childbearing age, who received no Tdap vaccine 5 years prior to sample collection, at the beginning of the pandemic (May-June 2020) and nearly one year later (February-May 2021). Logged anti-*B. pertussis*-specific IgG levels were compared using paired t-tests as appropriate.

Results: Pertussis toxin (PT), filamentous hemagglutinin (FHA) and pertactin (PRN) IgG levels declined in women of childbearing age one year into COVID-19 pandemic, 6.8 IU/ml (95%CI, 4.2-10.9) vs. 8.4 IU/ml (5.1-13.9) ($p=0.004$), 18.8 IU/ml (10.9-32.2) vs. 23.6 IU/ml (13.2-42.1) ($p<0.001$) and 39.0 IU/ml (18.6-81.8) vs. 54.6 IU/ml (27.3-109.0) ($p=0.076$), respectively.

Conclusions/Learning Points: Anti-*B. pertussis* IgG levels were low and decreased significantly in 2021 compared to early pandemic levels measured in 2020 in female of reproductive age. In the era of relaxing of mitigation strategies to control COVID-19 pandemic, gestational pertussis immunization should be reinforced.

EP086 / #590

Topic: AS03. Vaccines (only non SARS-CoV2 content) / AS03.f. Vaccine hesitancy

KNOWLEDGE GAPS IN PARENTAL UNDERSTANDING OF INVASIVE MENINGOCOCCAL DISEASE AND ASSOCIATED VACCINES: RESULTS FROM A GLOBAL QUESTIONNAIRE

E-Posters

E-POSTER VIEWING

Nevena Vicic¹, Isabella Ballalai², Vinny Smith³, Michael Horn⁴, Rafik Bekkat-Berkani¹, [Lamine Soumahoro](#)⁵

¹GlaxoSmithKline, N/a, Rockville, United States of America, ²Brazilian Immunization Society, N/a, Rio de Janeiro, Brazil, ³Meningitis Research Foundation, N/a, Bristol, United Kingdom, ⁴Pediatric Office Dr. Horn, N/a, Schoenau, Germany, ⁵GlaxoSmithKline, N/a, Wavre, Belgium

Backgrounds: Current available literature suggests that parents have a relatively good understanding of invasive meningococcal disease (IMD). However, knowledge gaps in their understanding of meningococcal serogroups and available vaccines still exist. An online questionnaire was conducted prior to the COVID-19 pandemic to understand the breadth of knowledge that parents have about IMD and available vaccines to help prevent it.

Methods: A questionnaire conducted by Ipsos on behalf of GlaxoSmithKline included parents/guardians of children/adolescents from Australia, Brazil, Germany, Greece, Italy, Spain (aged between 2 months and 10 years), UK (aged 5–20 years) and US (aged 16–23 years).

Results: Overall, 3600 parents of 6702 children responded. Most respondents (65%) were aware that IMD is a rare and severe disease. Yet, 50% were unsure of their children's IMD vaccination status. Only 36% were fully aware that different vaccines help protect against different IMD serogroups, and only 34% were fully aware that vaccines against serogroup B differ from vaccines against other serogroups. Although most respondents (64%) had discussed IMD vaccination with their healthcare providers (HCPs), 33% could not recall discussions about serogroup B. Post questionnaire completion, most respondents reported that they will definitely/probably engage with their children's HCP (70%), conduct their own research (67%), talk with family/friends (60%) or other parents (56%).

Conclusions/Learning Points: The questionnaire results suggest that parents generally have a good understanding of IMD. However, there is an evident knowledge gap regarding the various serogroups and associated vaccines. Education initiatives and effective communication are needed to improve parental and HCP awareness, and support parents in making informed decisions about IMD vaccination. Further studies are warranted to assess the impact of the COVID-19 pandemic on parental understanding of meningococcal vaccines.

Topic: AS04. Immunology & compromised host / AS04.a. Host-pathogen interaction

IMPORTANCE OF IMMUNE RESPONSE AND FILAGGRIN IN PREMATURE NEWBORNS WITH VIRAL INFECTION DURING NICU STAY

E-Posters

E-POSTER VIEWING

Antonio Ruiz-Vicente¹, Leticia Labanda², Laura Sanchez García², Celia Fabra², M^a Luz García García³, Izaskun Dorronsoro⁴, Adelina Pellicer², Fernando Cabañas⁴, Sonia Alcolea⁵, Lidia Pertiñez⁵, Jorge Atucha⁵, Teresa Del Rosal⁵, Ersilia Gonzalez-Carrasco¹, José Rodrigo-Muñoz⁶, Beatriz Sastre⁶, Raquel García-Latorre⁶, María Iglesias-Caballero⁷, Noelia Reyes⁷, Diana Santos⁷, Vanesa Montero⁷, Francisco Pozo⁷, Inmaculada Casas⁷, Victoria Del Pozo⁶, Cristina Calvo⁵

¹Hospital Severo Ochoa, Neonatology, Leganés, Spain, ²Hospital La Paz, Neonatology, Madrid, Spain, ³Hospital Severo Ochoa, Pediatrics, Leganés, Spain, ⁴Hospital Quirón, Neonatology, Madrid, Spain, ⁵Hospital La Paz, Pediatric Infectious Diseases, Madrid, Spain, ⁶Fundación Jimenez Díaz, Immunology, Madrid, Spain, ⁷Centro Nacional de Microbiología, Influenza And Other Viruses Laboratory, Madrid, Spain

Backgrounds: Respiratory viral infections (RVIs) are frequent in premature newborns (PTNB) admitted to Neonatal Intense Care Unit (NICU) and may have long-term impact on respiratory morbidity, especially in infants with bronchopulmonary dysplasia. The immune response and respiratory epithelial barrier integrity are key defence elements. Objective: To evaluate the immune response and respiratory barrier regulation of PTNB with RVIs in NICU.

Methods: Nasopharyngeal aspirate (NPA) was obtained from PTNB, separating cells from supernatants. Viral detection was performed by 3 Multiplex RT-PCRs and gene expression of immune and barrier molecules by qPCR. Proteins were detected by western blot (cells) and ELISA or Luminex (supernatants). Small airway epithelial cells(SAEC) were stimulated with poly:IC and/or wounds to simulate infection.

Results: Basal samples from 26 PTNB that later developed RVIs had less frequency of filaggrin gene expression and lower protein levels compared to 23 noninfected controls. Conversely, the quantity values of filaggrin, IL-1 β , MIP-1 β , VEGF and HIF-1 α were higher in basal samples of NPA supernatants from viral positive newborns. In this group IL-17A, RANTES, VEGF, and HIF-1 α increased from basal samples compared to the positive and postpositive viral samples, while MCP-1 and amphiregulin were reduced after infection and never recovered. When SAEC were stimulated by poly:IC filaggrin gene expression was reduced and its levels at supernatant were increased, similarly as in NPA from newborns. Finally, poly:IC stimulation over SAEC increased TLR3 and TSLP expression, while AREG was reduced.

Conclusions/Learning Points: Filaggrin gene expression and protein quantity was reduced at cellular level of the NPA, while its secreted levels were increased in basal samples from infected newborns and in SAEC stimulated with poly:IC. Our findings highlight the importance of filaggrin as a factor facilitating VRIs.

EP090 / #1552

Topic: AS04. Immunology & compromised host / AS04.c. Severe/systemic fungal infections

INVASIVE MUCORMYCOSIS IN A CHILD WITH BONE MARROW FAILURE

E-Posters

E-POSTER VIEWING

Takwa Lamouchi, Samia Rekaya

Centre National de Greffe de Moelle Osseuse de Tunis, Immuno-hématologie Et Oncologie Pédiatriques, Tunis, Tunisia

Title of Case: Invasive mucormycosis in a child with bone marrow failure

Background: Mucormycosis in children with bone marrow failure has a particularly dismal prognosis. We herein report a case of a child with bone marrow failure and active rhino cerebral mucormycosis infection who was treated with aggressive surgical debridement and antifungal therapy.

Case Presentation Summary: The patient was a 12-year-old girl. At presentation, CBC showed a severe bone marrow failure with important fever related to a pulmonary infection due to pneumonia klebsiella. On day +45, the patient had clinical signs of ethmoiditis. Computerized tomography scan (CT-scan) on day 0 showed ethmoiditis with orbital cellulitis and found no cerebral involvement. On day +1 nasal endoscopy with pathology confirmed the infection to *Rhizopus Arrhizus*. The patient was started on Amphotericin B 1mg/kg/day due to the unavailability of liposomal form. She went three surgical debridements in one week on day +2, +3, and +7. On day +11 repeat CT scan of the orbit and the brain showed worsening disease in the right paranasal sinuses with bony erosion subperiosteal abscess of the orbit and bifrontal brain involvement. Only on day +13 we managed to have the liposomal Amphotericin B and the patient was switched to 7mg/kg/day. Because of slow improvement the patient was started on Lenograstim but the neutrophil count didn't show any improvement so it was stopped within seven days. The patient received a total of 25 days of Amphotericin B and L-Amb but the infection couldn't be controlled. She died on day +26.

Learning Points/Discussion: Mucormycosis is a serious fungal infection in neutropenic patients. For our patient syngeneic transplant could have been a reasonable choice with active mucormycosis, taking into consideration the absence of need for corticosteroids and immunosuppressive therapy post-transplant.

EP091 / #1583

Topic: AS04. Immunology & compromised host / AS04.c. Severe/systemic fungal infections

INVASIVE ASPERGILLOSIS DUE TO ASPERGILLUS NIGER IN IMMUNOCOMPROMISED CHILDREN

E-Posters

E-POSTER VIEWING

Takwa Lamouchi, Samia Rekaya

Centre National de Greffe de Moelle Osseuse de Tunis, Immuno-hématologie Et Oncologie Pédiatriques, Tunis, Tunisia

Title of Case: Invasive fungal infections due to Aspergillus Niger

Background: Invasive fungal infections are common among pediatric hematology patients who have acquired neutropenia. Aspergillus is one common fungal pathogen in this population. Classically, the identified species are either Aspergillus Fumigatus or Flavus. Aspergillus Niger remains less common and usually more aggressive. Herein we present two cases of children who had severe fungal infections due to Aspergillus Niger.

Case Presentation Summary: The first patient was a 4 years old boy who was receiving chemotherapy for acute lymphoblastic leukemia. He also had sickle cell disease. At day +12 from the beginning of chemotherapy he developed a septic shock. He was started on empiric broad spectrum antibiotics and chemotherapy was suspended. On day +24, he developed clinical signs of ethmoiditis. CT-scan showed ethmoiditis with orbital cellulitis and found no cerebral involvement. Nasal endoscopy with pathology confirmed the infection to Aspergillus Niger. He received L-Amb 10mg/kg/day for 34 days then he received 75 days of Voriconazole. Pansinusitis with no cerebral involvement were found on the latter CT-scan. Chemotherapy was resumed within two months of antifungal treatment. The pansinusitis hasn't regressed but it hasn't worsened either. The second patient was a 5 years old boy who had chronic septic granulomatosis and developed severe pneumonia. The bronchoalveolar liquid analysis showed Aspergillus Niger. He received intravenous Voriconazole for a month then he kept taking it orally (with stable therapeutic levels) until he underwent bone marrow transplant. Now he is three months past the transplantation, he is still taking Voriconazole orally and he has no more clinical signs. Aspergillus antigen test came negative for both patients.

Learning Points/Discussion: Aspergillus Niger is responsible for serious infection in children with neutropenia. Intravenous treatment for long periods is necessary.

EP092 / #1866

Topic: AS04. Immunology & compromised host / AS04.c. Severe/systemic fungal infections

INVASIVE ASPERGILLOSIS FROM ASPERGILLUS TERREUS PRESENTING WITH HEMOPTYSIS IN A CHILD WITH RESPIRATORY CHRONIC GVHD AFTER HEMATOPOETIC STEM CELL TRANSPLANTATION

E-Posters

E-POSTER VIEWING

Evdoxia Mpourazani¹, Kalliopi Straka¹, Marilena Prapa¹, Maria Gavra², Christina Oikonomopoulou³, Panagiotis Poulos¹

¹AGIA SOPHIA CHILDRENS HOSPITAL, Pediatric Intensive Care Unit, Athens, Greece, ²AGIA SOPHIA CHILDRENS HOSPITAL, Department Of Computed Tomography And Magnetic Resonance Imaging, ATHENS, Greece, ³AGIA SOPHIA CHILDRENS HOSPITAL, Department Of Hematopoetic Stem Cell Transplantation, ATHENS, Greece

Title of Case: INVASIVE ASPERGILLOSIS FROM *Aspergillus terreus* PRESENTING WITH HEMOPTYSIS IN A CHILD WITH RESPIRATORY CHRONIC GVHD AFTER HEMATOPOETIC STEM CELL TRANSPLANTATION

Background: Invasive fungal infections cause significant morbidity and mortality in patients with HSCT. Pulmonary Aspergillosis remains a challenging diagnosis with subacute clinical presentation and multiple imaging faces.

Case Presentation Summary:

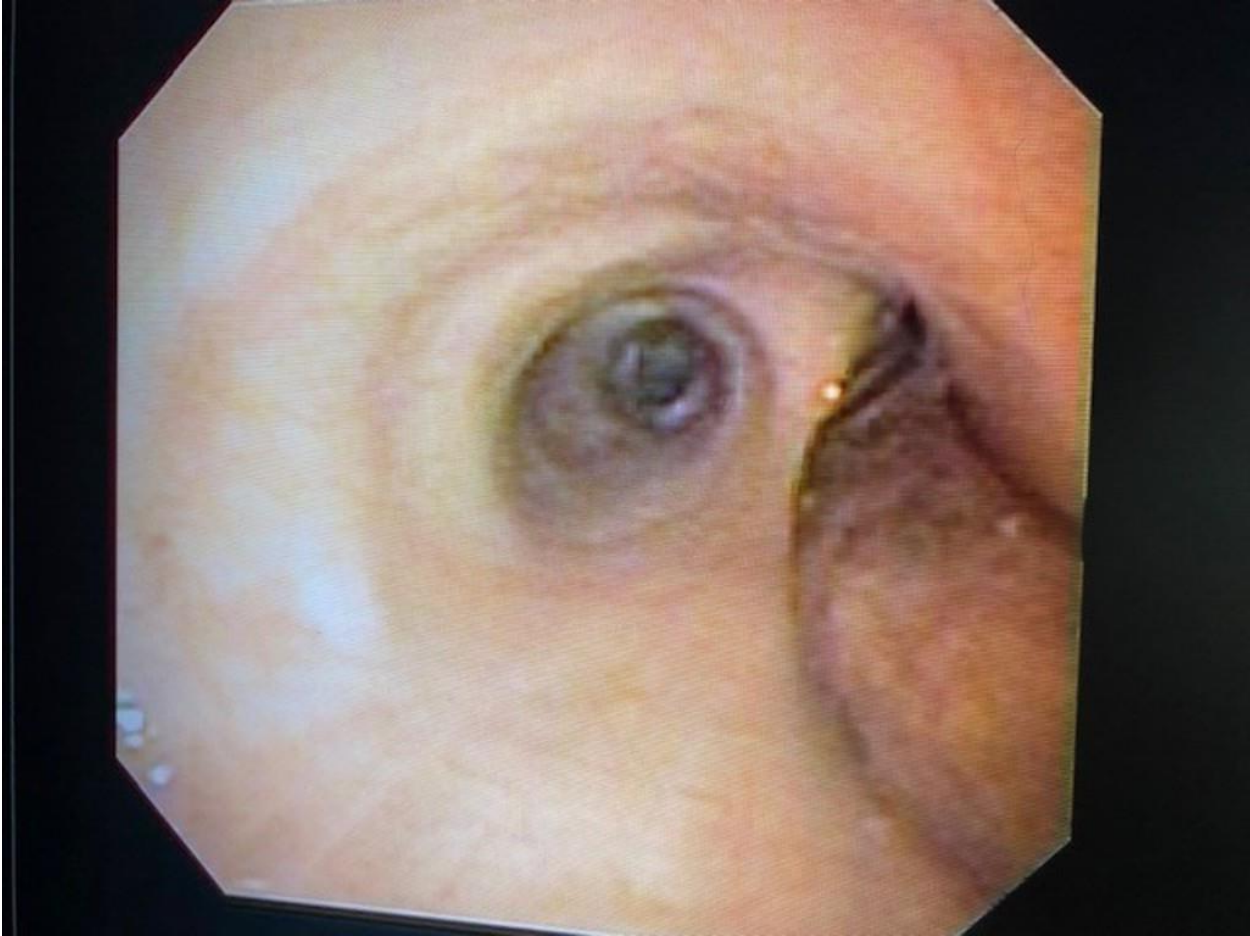

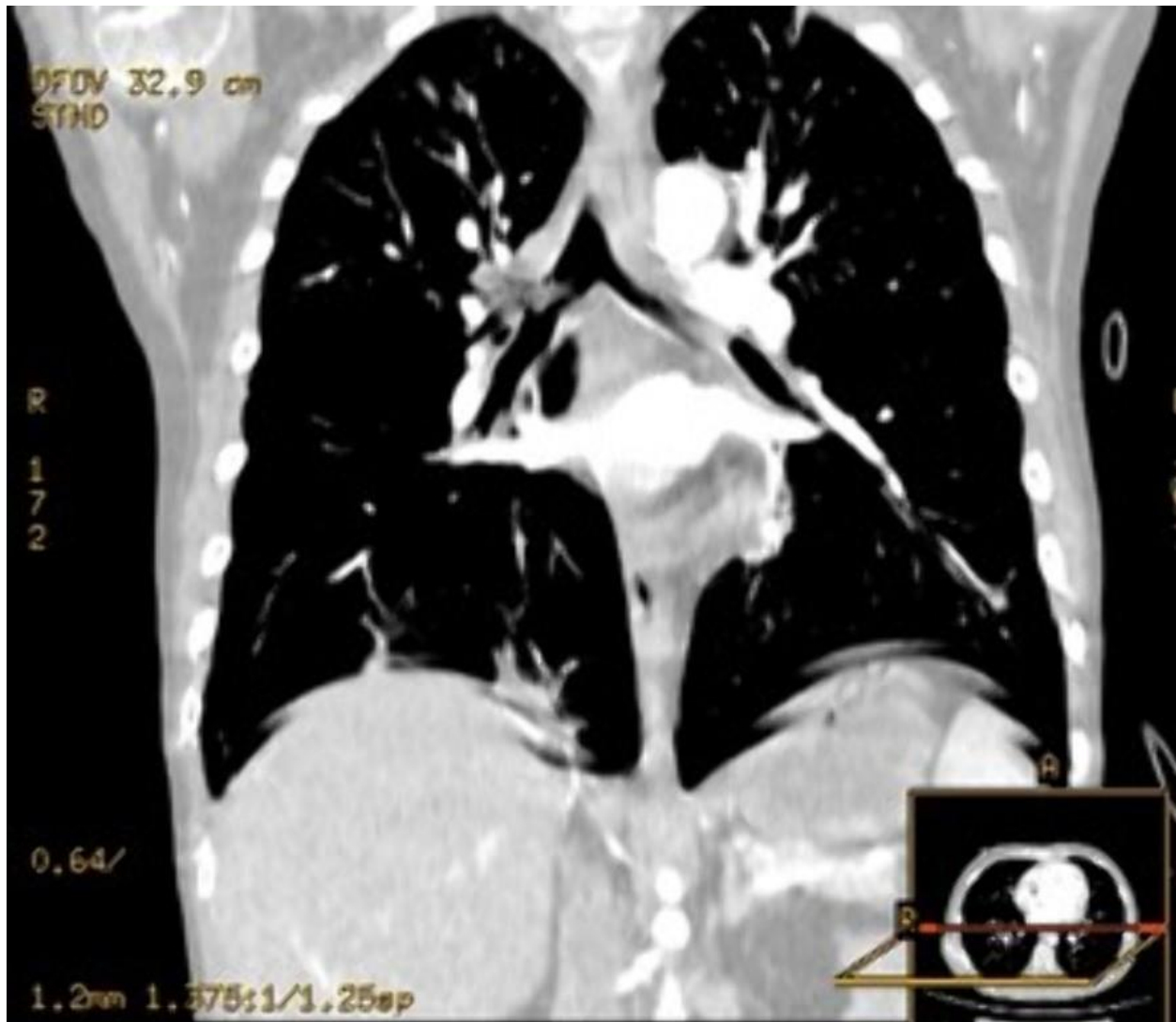

A 10 year old boy with MDS underwent HSPT from a matched unrelated donor. Soon after transplantation the child developed progressing cough and wheezing. Microbiological and imaging tests were normal. Graft failure was established and a second HSCT was planned. Late post-engraftment phase complicated by acute exacerbation of his chronic respiratory symptoms, with fever, hypoxemia and ground-glass appearance on CT scan. Blood PCR revealed CMV reactivation and *Aspergillus terreus* was isolated from BAL cultures. Despite multiple antifungal combinations he never managed to eradicate the mould. Nevertheless, idiopathic pneumonia in the context of chronic GVHD was considered to be the patient's main pathology and an escalation of immunosuppressive therapy. Four months later he presented with hemoptysis and CT scan revealed an Aspergilloma of the right upper lobe, penetrating the wall of the unilateral main bronchi. The finding was confirmed by bronchoscopy. Acute hemorrhage was controlled with conservative means, immunosuppressive therapy was de-escalated, and he received an antifungal combination with caspofungin, intravenous and inhaled voriconazole. Due to chronic respiratory failure and underlying cGVHD, therapeutic choices for source control are limited and the patient remains in danger for a new, probably fatal episode of hemoptysis.

Learning Points/Discussion: The equilibrium between immunosuppressive therapy for cGVHD and early, successful treatment of opportunistic infections in patients with HSCT is frequently delicate and fragile. Alongside, due to complex underlying pathology of such patients, diagnosis and treatment are frequently delayed, unsuccessful and unattainable

EP093 / #65

Topic: AS04. Immunology & compromised host / AS04.d. Infections in immunocompromised/ immunodeficient patients

INFECTION RELATED MORTALITY IN PEDIATRIC ACUTE MYELOID LEUKEMIA , FEBRILE NEUTROPENIC EPISODES ANALYSIS , SINGLE INSTITUTE EXPERIENCE .

E-Posters

E-POSTER VIEWING

Ahmed Bayoumi, Reham Khedr, Alaa Elhaddad
National Cancer Institute, Pediatric Oncology, GIZA, Egypt

Backgrounds: Children with acute myeloid leukemia (AML) are at high risk for infectious complications related to intensive chemotherapy. Infections lead to mortality and prolonged hospitalization. The aim of the study is to: assess infectious complications and assess outcome of febrile episodes in children with AML at the Pediatric Oncology Department, National Cancer Institute, Cairo University 2016-2018.

Methods: Infectious complications were evaluated retrospectively in 621 febrile episodes in 101 Patients: were divided into survivors and non-survivors according to outcome at end of each episode. Each febrile episode was interpreted in correlation with infectious complications .

Results:

| Risk Factor | Mortality | p value |
|---|-----------|---------|
| Septic shock | 55% | <0.001 |
| Septic shock with MDRO | 72% | |
| Cardiac impairment/inotropic support | 65.60% | |
| Presence Of Central venous line | 18.30% | |
| Episode duration >18 days | 20.50% | |
| Start of antimicrobial in relation to start of chemotherapy < 16 days | 33% | |
| Episodes : Not in remission | 15.60% | |

Summary of Significant laboratory and clinical predictors of mortality

| Risk factor | Mortality | p value |
|--|-----------|-----------------|
| CRP more than or equals 90 mg/l | 24.4% | Not significant |
| ANC LESS THAN 500 | 29.9% | 0.003 |
| Hgb less than or equals to 7 g/dl | 19.9% | 0.633 |
| Platelets less than 20000/cc | 29.9% | 0.299 |
| Liver impairment (grades 3 and 4) | 42.2% | 0.025 |
| Electrolyte imbalance (grades 3 and 4) | 24.1% | 0.003 |
| Renal impairment | 56.8% | 0.025 |

Mortality from gram negative bacteremia was 29.9%, in febrile episodes with multidrug resistant gram negative bacteremia: Mortality was 39.2 % .In febrile episodes with multidrug resistant gram negative bacteremia and septic shock. Mortality was 71.8 % (p value <0.001). Mortality was high in early chemotherapy phase (intensive timing). Infection related mortality was 39%. In our institute there is epidemiological shift towards gram negative organisms .In clinically documented febrile episodes: Mortality was 13.2 % (p value <0.001). Mortality rate was 15.3% for patients who presented with pneumonia, as compared to 6 % who hadn't. (P value = 0.001) .It was 25.7% for patients who had typhillitis/colitis, as compared to 9% who hadn't. (P value <0.001; statistically significant). However, it was

11.7% for patients who had soft tissue infection. In clinically documented febrile episodes with multidrug resistant gram-negative bacteremia: Mortality was 42.9% (p value =0.122). Mortality from febrile episodes with ICU admission was 58.5 %. (P value <0.001).

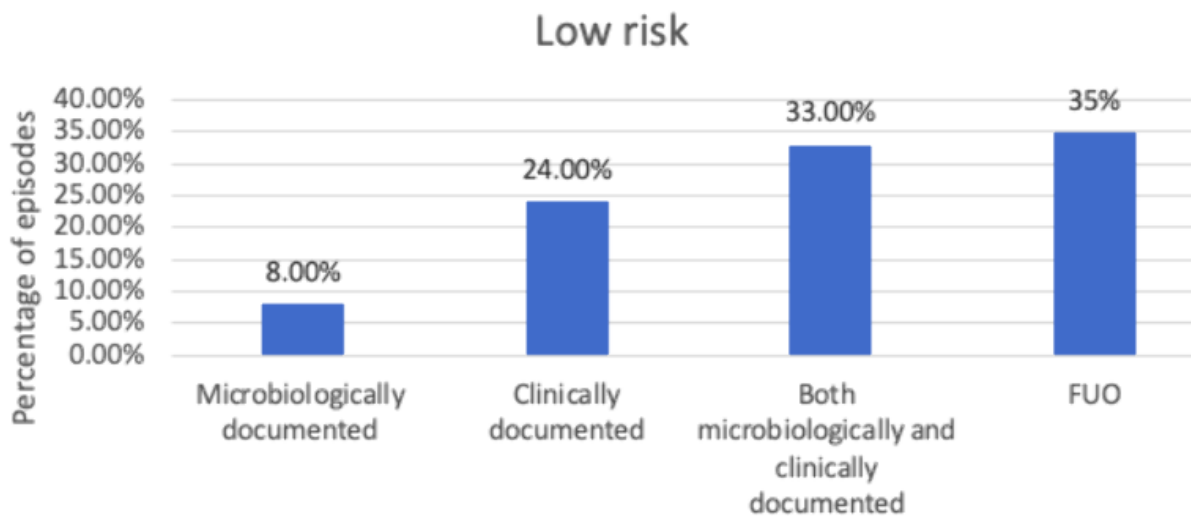
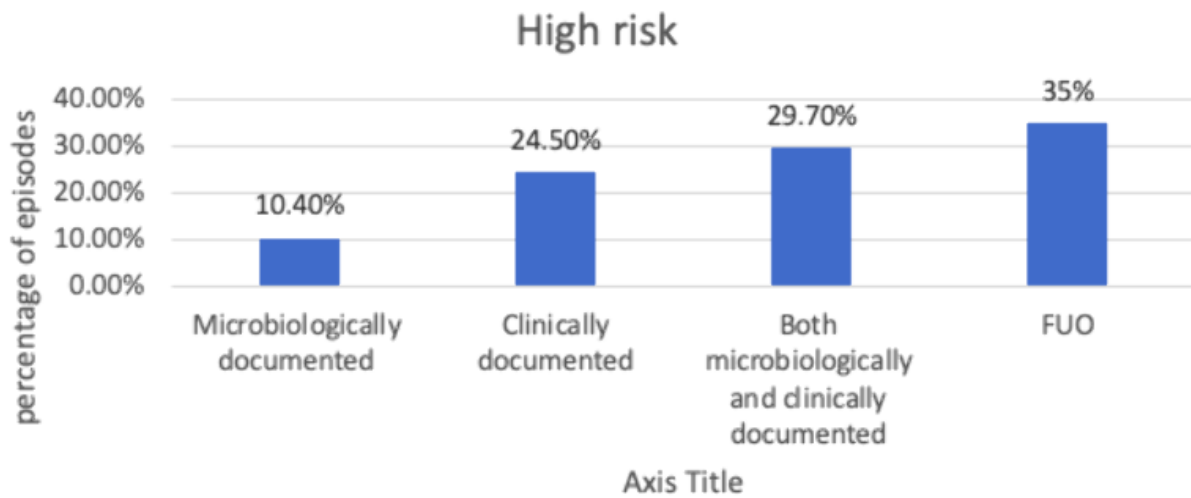

Conclusions/Learning Points: Sepsis and septic shock are major causes of mortality. Awareness of the presenting characteristics and prompt management is important. Improved management of sepsis during neutropenia may reduce the mortality of pediatric Acute myeloid leukemia.

EP094 / #1076

Topic: AS04. Immunology & compromised host / AS04.d. Infections in immunocompromised/immunodeficient patients

ACUTE RESPIRATORY FAILURE SECONDARY TO PNEUMOCYSTIS JIROVECCI PNEUMONIA AS AN INITIAL MANIFESTATION OF PRIMARY IMMUEDEFICIENCY IN INFANTS. THREE CASE REPORTS FROM A SINGLE CENTER.

E-Posters

E-POSTER VIEWING

Eleni Christakou, Kalliopi Straka, Marilena Prapa, Evdoxia Mpourazani, Chariklia Barbaresou
AGIA SOFIA CHILDRENS HOSPITAL, Picu, ATHENS, Greece

Title of Case: ACUTE RESPIRATORY FAILURE SECONDARY TO PNEUMOCYSTIS JIROVECCI PNEUMONIA AS AN INITIAL MANIFESTATION OF PRIMARY IMMUEDEFICIENCY IN INFANTS. THREE CASE REPORTS FROM A SINGLE CENTER.

Background: Pneumocystis jirovecii is the cause of severe interstitial pneumonia in immunocompromised hosts. Pneumocystis pneumonia(PCP) in children can be an initial clinical manifestation of primary immune deficiency.

Case Presentation Summary: We describe three cases of infants who developed acute respiratory failure secondary to pneumocystis jirovecci pneumonia and were diagnosed with primary immunodeficiency. Three infants 2 males and 1 female (ages ranging from 5,5 to 7,5 months), with unremarkable previous medical or birth history, presented with a 3 to 10 days history of profound tachypnea, cyanosis, hypoxemia while remaining afebrile. Mechanical ventilation(MV) was initiated soon after admission to hospital. Physical examination revealed no accessory breathing sounds on auscultation despite tachypnea. Chest X-ray showed bilateral diffuse infiltrates. Chest CTscan revealed diffuse bilateral ground-glass infiltrates and interstitial lung involvement. Bronchoscopy was performed in all patients and PCR test of BAL reported positive for P.jirovecci and negative for other pathogens. 1,3- β -D glucan was positive. Immunologic evaluation revealed underlying Combined Immunodeficiency(CID) in all patients. Trimethoprim/sulfamethoxazole(TMP/SMX) was the main therapeutic agent. Two patients were treated with TMP/SMX and pentamidine/micafungin combination therapy and one with pentamidine and caspofungin due to G6PD deficiency. They also received intravenous IgG replacement therapy and methylprednisolone. All patients responded to treatment and after 14 to 25 days of MV they were extubated and eventually discharged from PICU(LOS 15-41days). One infant received hematopoietic cell transplantation.

Learning Points/Discussion: PCP is a common but often unrecognised presenting feature of immunodeficiency and should be considered in infants presenting with severe interstitial pneumonia even without evidence of an immunocompromised state. Once detected should be aggressively treated. A diagnosis of PCP in an infant should raise suspicion for primary immune deficiency.

EP095 / #1596

Topic: AS04. Immunology & compromised host / AS04.d. Infections in immunocompromised/ immunodeficient patients

A 8 YEARS OLD FEMALE PATIENTS WITH NEPHRITIS SYSTEMIC LUPUS ERYTHEMATOSUS AND DISSEMINATED HERPES ZOSTER: A CASE REPORT

E-Posters

E-POSTER VIEWING

Heppy Roosarina Rahayu Dewi, Eggi Arguni, Ida Laksanawati, Rr. Ratni Indrawanti
Sardjito hospital, Child Health, Yogyakarta, Indonesia

Title of Case: A 8 YEARS OLD FEMALE PATIENTS WITH NEPHRITIS SYSTEMIC LUPUS ERYTHEMATOSUS AND DISSEMINATED HERPES ZOSTER: A CASE REPORT

Background: Systemic lupus erythematosus (SLE) is a complex autoimmune condition, which is characterized by exaggerated activity of the immune system which often causes severe complications, such as SLE nephritis and disseminated herpes zoster (DHZ). The prevalence of Herpes Zoster (HZ) is estimated at 40% in immunocompromised patients.

Case Presentation Summary: A female patient, 8 years old came to the ED complained of vesicles all over her body. 6 days before admission there was a red rash on the palm of the left hand which then spread to other parts of the body. The vesicles were itchy and painful but the patient did not have a fever. The patient was diagnosed as SLE since the age of 8 years old and was undergoing a second month protocol with a regimen of MP pulse, MMF and hydroxychloroquine. On the third day of treatment the patient experienced septic shock and was admitted to the PICU for 9 days with treatment of fluid therapy, antibiotics, epinephrine and norepinephrine. On the proximal of the upper extremities found bluish signs, was consulted to the thoracic and vascular surgery and from CT Angiography found no vasculitis. Result of consultation the dermatovenerology department supported to diagnosis of DHZ. Acyclovir was administered for 10 days. The patient's condition was improved.

Learning Points/Discussion: SLE patients are prone to reactivation of the varicella zoster virus due to disorders of the intrinsic immune system and immunosuppressive therapy, thus may be more susceptible to HZ infection and undergo disseminated HZ complications. SLE nephritis is one of the most serious complications of SLE caused by the deposition of immune complexes in the kidneys.

EP096 / #1601

Topic: *AS04. Immunology & compromised host / AS04.d. Infections in immunocompromised/ immunodeficient patients*

STAGE II HIV- INFECTED ADOLESCENT WITH CYTOMEGALOVIRUS (CMV) INFECTION: A CASE REPORT

E-Posters

E-POSTER VIEWING

Heppy Roosarina Rahayu Dewi, Ida Laksanawati, Eggi Arguni, Rr. Ratni Indrawanti
Sardjito hospital, Child Health, Yogyakarta, Indonesia

Title of Case: STAGE II HIV- INFECTED ADOLESCENT WITH CYTOMEGALOVIRUS (CMV) INFECTION: A CASE REPORT

Background: Adolescence (10-19 years) is a phase of physical growth and development accompanied by sexual maturation, often leading to intimate relationships. Adolescent HIV/AIDS is a separate epidemic and needs to be handled and managed separately from adult HIV. Childhood sexual abuse is one of various risk factors and situations for adolescents contracting HIV virus.

Case Presentation Summary: A male 15 years old, admitted to our hospital with confirmed diagnosis of HIV stage 2, and history of sexual transmission. He was undergo ARV treatment using FDC regiment consist of Tenofovir, lamivudine and Efavirenz. Baseline CD4 absolut count was 19 cells/uL, CD4 percentage of Lymphs 2%. Prior to admission he complained of severe headache, fever, mental alternation and be diagnosed as cytomegalovirus (CMV) encephalitis caused by CMV infection based on MSCT examination and urine-blood antigenemia. Valgancyclovir 450mg twice a day then was given for six weeks. Manitol also was given because of cerebral oedema.

Learning Points/Discussion: CMV infection usually causes asymptomatic disease in immunocompetent individuals. Severe CMV disease is typically seen in advanced AIDS with CD4 counts less than 50 cells/ μ L. Valganciclovir is effective for prophylaxis and treatment of CMV in HIV patients. However, treatment of CMV infection with meningitis still needs further research regarding the need for antiviral administration.

EP097 / #390

Topic: AS04. Immunology & compromised host / AS04.d. Infections in immunocompromised/ immunodeficient patients

AN ELEVEN-MONTH-OLD CASE OF ADENOSINE DEAMINASE (ADA) DEFICIENCY PRESENTING WITH RESPIRATORY DISTRESS, PROLONGED DIARRHEA AND SEVERE LYMPHOPENIA

E-Posters

E-POSTER VIEWING

Yalçın Kara¹, Mahmut Kizil¹, Feride Candan², Ebru Kaçmaz³, Mehmet Arslanoğlu³, Eylem Kiral³, Gurkan Bozan³, Ömer Kılıç¹, Koray Harmancı², Ener Cagri Dinleyici³

¹Eskişehir Osmangazi University, Pediatric Infectious, Eskişehir, Turkey, ²Eskişehir Osmangazi Medical University, Pediatric Allergy And Immunology, Eskişehir, Turkey, ³Eskişehir Osmangazi Medical University, Pediatric Intensive Care, Eskişehir, Turkey

Title of Case: An eleven-month-old case of Adenosine Deaminase (ADA) deficiency presenting with respiratory distress, prolonged diarrhea and severe lymphopenia

Background: Adenosine deaminase (ADA) deficiency is an inherited disorder that damages the immune system and causes severe combined immunodeficiency (SCID). Cases with variable age of onset, severity of symptoms and prognosis have been reported due to the wide clinical and mutation spectrum. Here, an 11-month-old ADA deficiency case presenting with respiratory distress, prolonged diarrhea and severe lymphopenia.

Case Presentation Summary: An 11-month-old male patient presented with fever, cough and vomiting. It was learned from his story that, these complaints had been occurring for about 2 days and were gradually increasing. On physical examination, tachypnea, respiratory distress and decreased turgor tone. In laboratory tests, hemoglobin 11.9 g/dL, leukocyte 7290/mm³ (neutrophil 5840/mm³, lymphocyte 470/mm³), platelet 348,000/mm³, C-reactive protein 4.9 mg/L (0-5). Oxygen support, hydration and methylprednisolone treatment were started. In the follow-up, diarrhea was started 8-10 times a day, fluid-electrolyte support and probiotic treatment were began. However, diarrhea continued for about 2 weeks. The patient with prolonged diarrhea, growth retardation and resistant lymphopenia was consulted to the pediatric immunology department for immune deficiency. ADA enzyme level was studied with low CD4-T lymphocyte and lymphopenia. Enzyme replacement therapy was initiated for the patient whose deoxyadenosine level was 6.66 µmol/l (<0.1) and a heterozygous mutation in the ADA gene for p.Y97x(c.290dup) and pY290H(c.868>C). His respiratory distress regressed and he was referred to another health institution for bone marrow transplantation.

Learning Points/Discussion: ADA deficiency is one of the severe combined immunodeficiencies and may present with different clinical findings depending on the degree of enzyme deficiency. Immunodeficiencies should be kept in mind especially in patients with deep lymphopenia, growth-development retardation and a history of resistant infection.

EP098 / #623

Topic: AS04. Immunology & compromised host / AS04.d. Infections in immunocompromised/immunodeficient patients

ORAL INTRAVENOUS IMMUNOGLOBULIN TREATMENT IN ACUTE GASTROENTERITIS OF IMMUNOCOMPROMISED PATIENTS: A CASE SERIES

E-Posters

E-POSTER VIEWING

Zeynep Ergenç¹, Eda Kepenekli¹, Sevgi Aslan¹, Seyhan Yılmaz¹, Elif Aydiner²

¹Marmara University School of Medicine, Pediatric Infectious Diseases, Istanbul, Turkey, ²Marmara University School of Medicine, Pediatric Immunology And Allergy, Istanbul, Turkey

Backgrounds: Acute gastroenteritis in immunocompromised patients can be severe, causing the need for hospitalization and exacerbating the complications of the underlying disease. In some studies, positive results have been obtained by oral administration of intravenous immunoglobulin (IVIG) in acute gastroenteritis cases with immunosuppressive disease or with a severe course than expected. In this study, the clinical features and treatment responses of cases followed in our clinic for acute gastroenteritis and treated with oral IVIG are presented.

Methods: Seven patients who were followed up with the diagnosis of acute gastroenteritis and treated with oral IVIG at Marmara University Pendik Training and Research Hospital between December 2019-September 2021 were included. The demographic and clinical characteristics of the patients were recorded retrospectively. A decrease of at least 30% in the frequency of diarrhea within 48 hours of oral IVIG therapy was considered as a positive response to treatment.

Results: The median age of the patients was 48 (min:3, max: 172) months. All patients had comorbidity. The pathogen was detected as giardiasis in 2 patients, rotavirus in 2 patients, norovirus in 1 patient, adenovirus in 1 patient, and rotavirus and adenovirus in 1 patient. Diarrhea was seen in 6 patients with a frequency of more than 10, mean diarrhea frequency was 16.6 (min: 10, max: 25). In an immunodeficient patient with no diarrhea, refractory giardiasis was detected. All patients received 300 mg/kg/dose oral IVIG. In 2 patients (33%) of 6 patients with diarrhea, a positive response to oral IVIG therapy was obtained.

Conclusions/Learning Points: Oral IVIG therapy may yield positive results in the management of selected cases of gastroenteritis with an underlying disease. More comprehensive studies are needed to determine the treatment dose and posology for oral IVIG administration.

EP099 / #722

Topic: *AS04. Immunology & compromised host / AS04.d. Infections in immunocompromised/ immunodeficient patients*

STAPHYLOCOCCAL TOXIC SHOCK SYNDROME SECONDARY TO LIVER ABSCESS IN A CHILD WITH PAPILLON LEFEVRE SYNDROME

E-Posters

E-POSTER VIEWING

Zeynep Ergenç¹, Eda Kepenekli¹, Aslı Timur², Sevgi Aslan¹, Seyhan Yılmaz¹, Safa Baris³

¹Marmara University School of Medicine, Pediatric Infectious Diseases, Istanbul, Turkey, ²Marmara University School of Medicine, Pediatrics, Istanbul, Turkey, ³Marmara University School of Medicine, Pediatric Immunology And Allergy, Istanbul, Turkey

Title of Case: Staphylococcal Toxic Shock Syndrome Secondary to Liver Abscess in a Child with Papillon LeFevre Syndrome

Background: Staphylococcal toxic shock syndrome (TSS) is a toxin-mediated disease caused by TSS toxin-1 and other enterotoxins produced by *Staphylococcus aureus*. Definitive cases must include all of the 5 criteria from the following 1) fever, 2) rash, 3) desquamation, 4) hypotension and 5) multisystem organ involvement. Here we present a definitive TSS case with primary immunodeficiency.

Case Presentation Summary: A 16-year-old boy with Papillon-LeFevre syndrome (altered neutrophil function, palmoplantar keratosis, and periodontopathy) was presented with fever. The physical examination and initial laboratory and imaging tests failed to reveal the source of fever. White blood cell count: 13000/mm³, absolute neutrophil count: 12300/mm³, absolute lymphocyte count: 400/mm³, hemoglobin: 8.3 g/dL, platelet count: 350000, C-reactive protein: 174 mg/L (0-5 mg/L). After blood, urine, and CSF cultures were drawn, intravenous ceftriaxone therapy has been started. An abscess (55x53 mm) was detected in the abdominal ultrasonography. Intravenous vancomycin and metronidazole were added to the antimicrobial therapy and the abscess was drained. On the second day, diffuse macular rash and hypotension developed. Since anaphylaxis could not be excluded, vancomycin, ceftriaxone, and metronidazole therapies were switched to linezolid, ciprofloxacin, and clindamycin. On follow-up, vomiting, generalized myalgia, conjunctivitis, and thrombocytopenia developed, then parenteral fluid therapy and immunoglobulin intravenous were administered with the diagnosis of TSS. Three consecutive peripheral blood cultures and abscess drainage cultures yielded methicillin-sensitive *Staphylococcus aureus*. The clindamycin was continued for 2 months until the abscess formation in the liver disappeared. The patient is still on follow-up without any sequelae.

Learning Points/Discussion: TSS is a life-threatening condition that must be kept in mind and must be treated promptly especially in immunodeficient patients.

EP100 / #646

Topic: AS04. Immunology & compromised host / AS04.d. Infections in immunocompromised/ immunodeficient patients

SARS-COV-2 PNEUMONIA IN A LIVER TRANSPLANTED CHILD WITH ACQUIRED DIAPHRAGMATIC HERNIA: CASE REPORT

E-Posters

E-POSTER VIEWING

Andrey Goncharov^{1,2}, Boryana Georgieva^{1,2}, Yordanka Uzunova^{1,2}

¹Sofia University "St. Kliment Ohridski", Medical Faculty, Sofia, Bulgaria, ²Hospital Lozenetz, Paediatric Clinic, Sofia, Bulgaria

Title of Case: SARS-COV-2 PNEUMONIA IN A LIVER TRANSPLANTED CHILD WITH ACQUIRED DIAPHRAGMATIC HERNIA: CASE REPORT

Background: The liver transplantation is a life-saving procedure that requires immunosuppressive therapy and increases the risk of severe infectious diseases. We are presenting a case of a SARS-CoV-2 pneumonia in a 15-months-old boy, one month after liver transplantation. The child is with Alagille syndrome. In the course of the investigation, a right sided acquired diaphragmatic hernia was established.

Case Presentation Summary: The child presented with respiratory failure, hypertension and increased inflammatory activity. Diagnosis of COVID-19 pneumonia was based on the positivity of the PCR test and computed tomography (CT) of the lungs that revealed typical bilateral ground-glass opacities. Imaging concurrently demonstrated a herniated intestinal mass in the right side of the thorax that compressed the right lung. The patient was treated with oxygen supplementation, antibiotics, antihypertensive drugs, reduced immunosuppressive regimen (tacrolimus) and low-molecular heparin. Due to the high operative risk, correction of the diaphragmatic hernia was postponed until resolution of the pneumonia. After 20 days the PCR for the virus was negative, combined with improved imaging studies. This led to a surgical correction of the diaphragmatic defect with a synthetic mesh without any complications.

Learning Points/Discussion: COVID-19 is a dangerous infection that can prove troublesome and reduces survival in immunocompromised patients especially when combined with other concurrent diseases. Careful management with reduction of the immunosuppressive regimen, constant monitoring and aggressive treatment can lead to positive results.

EP101 / #1562

Topic: *AS04. Immunology & compromised host / AS04.d. Infections in immunocompromised/ immunodeficient patients*

A CASE OF COVID-19 IN A CHILD WITH CHRONIC GRANULOMATOUS DISEASE

E-Posters

E-POSTER VIEWING

Mykola Haras

Bukovinian State Medical University, Pediatrics And Pediatric Infectious Diseases, Chernivtsi, Ukraine

Title of Case: A case of covid-19 in a child with chronic granulomatous disease

Background: According to current information primary Immunodeficiency diseases in COVID-19 pandemic can be predisposing or protective factor. In some cases immunocompromised children are unlikely to be at a higher risk of developing severe COVID-19. Some study shows SARS-CoV-2 infections have occurred in immunocompromised children and young people with no increased risk of severe disease.

Case Presentation Summary: A 7-year-old boy with verified diagnosis of chronic granulomatous disease was under observation during inpatient treatment at the Chernivtsi Regional Children's Clinical Hospital. The child in past suffered from a urinary tract infection, axillary post-BCG lymphadenitis, purulent sinusitis, post-traumatic osteomyelitis, 4 episodes of pneumonia. The diagnosis of primary immunodeficiency was verified at age of 4 years old, he treated by co-trimatoxazole/trimethoprim and itraconazole. The child fell ill after contact with a classmate with a confirmed infection COVID-19, the disease began with hyperthermia, respiratory symptoms and submandibular lymphadenopathy. RT-PCR of nasopharyngeal swab was positive on SARS-CoV-2. General condition was severe because of respiratory failure. A child was hospitalized in the PICU, X-ray verified right viral-bacterial pneumonia in the lower lung lobe. Child was treated by oxygen and infusion therapy, glucocorticosteroids, ceftriaxone, as well as continued intake of co-trimatoxazole/trimethoprim and itraconazole. Laboratory parameters of CBC, coagulogram and D-dimer corresponded to the age reference values. On the 10th day of inpatient treatment with a negative PCR result for SARS-CoV-2 and positive clinical progress, the boy was discharged.

Learning Points/Discussion: A case demonstrates the necessity of active management and monitoring of suspected and confirmed case of coronavirus COVID-19 in children with primary immunodeficiency. Early verification of primary immunodeficiencies and the proper management of these cases under the supervision of an immunologist are also important.

EP102 / #846

Topic: AS04. Immunology & compromised host / AS04.d. Infections in immunocompromised/immunodeficient patients

PARVOVIRUS B19 INFECTION FOLLOWING PEDIATRIC ALLOGENEIC HEMATOPOIETIC CELL TRANSPLANTATION

E-Posters

E-POSTER VIEWING

Malcolm Holterhus¹, Heike Thorer¹, Hartmut Hillmann², Birgit Burkhardt¹, Andreas Groll¹

¹University Children's Hospital Muenster, Pediatric Hematology & Oncology, Münster, Germany, ²University Hospital Münster, Department Of Transfusion Medicine And Cellular Therapy, Münster, Germany

Title of Case: PARVOVIRUS B19 INFECTION FOLLOWING PEDIATRIC ALLOGENEIC HEMATOPOIETIC CELL TRANSPLANTATION

Background: Parvovirus B19 infection after pediatric allogeneic hematopoietic cell transplantation (HCT) remains a rare but under some circumstances challenging complication. There is little data in the literature regarding Parvovirus B19 infection in the context of pediatric HCT. Here we present the experience at the pediatric HCT program in Muenster.

Case Presentation Summary: During the time period between 1999 and 2021, three out of 466 (0.6%) children and adolescents undergoing allogeneic HCT developed symptomatic community-acquired parvovirus B19 infection post-transplant. While in two patients (aplastic anemia; aplastic anemia and hemolysis), viral replication and symptoms were ultimately controlled after taper of immunosuppression and a combination of immunomodulating interventions, respectively, in the third patient, symptomatic parvovirus B19 infections now persists for more than 34 months due to ongoing immunosuppression for chronic intestinal graft-vs.-host disease. In an additional patient, parvovirus B19 replication in blood was detected during the standard evaluation prior to transplantation, which led to the postponement of the procedure until resolution of replication. In a further patient, allogeneic HCT from a matched family donor was permanently cancelled due to persistent parvoviremia of this donor at the time of the planned transplantation.

Learning Points/Discussion: Parvovirus B19 infection is an uncommon complication after pediatric allogeneic HCT. Treatment options include the administration of intravenous immunoglobulins and taper of immunosuppressive therapy, if feasible; no antiviral treatments or cell-based adoptive immunotherapies exist. Whereas the infection itself is mostly not life-threatening, it may complicate the post-transplant course by impairing red blood cell production or by inducing auto-reactive antibodies and hemolytic anemia including hemolytic crisis. In patients with need for continuing and augmented immunosuppression for GVHD, viral replication may persist for prolonged periods of time with uncertain outcome.

EP103 / #1016

Topic: AS04. Immunology & compromised host / AS04.d. Infections in immunocompromised/ immunodeficient patients

INFECTION WITH MYCOBACTERIUM TUBERCULOSIS COMPLEX IN PEDIATRIC PATIENTS WITH INBORN ERRORS OF IMMUNITY: A TERTIARY CENTER 5-YEAR RETROSPECTIVE REVIEW

E-Posters

E-POSTER VIEWING

Andreea Ioan¹, Oana Maria Farkas¹, Maria Nica², Alexis Virgil Cochino³

¹National Institute for Mother and Child Alessandrescu Rusescu, Pediatric Immunology, Bucharest, Romania, ²Victor Babes Clinical Hospital of Infectious and Tropical Diseases, Microbiology, Bucharest, Romania, ³Carol Davila University of Medicine and Pharmacy, Pediatrics, Bucharest, Romania

Title of Case: INFECTION WITH MYCOBACTERIUM TUBERCULOSIS COMPLEX IN PEDIATRIC PATIENTS WITH INBORN ERRORS OF IMMUNITY: A TERTIARY CENTER 5-YEAR RETROSPECTIVE REVIEW

Background: Children account for 11% of mycobacterium tuberculosis (MTB) complex cases globally, with higher rates of extrapulmonary involvement than adults. Early manifesting infection in the first year of life should prompt extensive evaluation to identify an immune defect.

Case Presentation Summary: We conducted a retrospective review of children with MTB complex infection among a cohort of patients diagnosed with inborn errors of immunity between January 2016 to December 2021 at the Department of Immunology in a tertiary care pediatric hospital in Bucharest, Romania. 35 patients were identified with an inborn error of immunity (IEI) over 5 years, the majority males (27 patients, 77%). 28 patients (80%) had confirmatory genetic mutations for their IEI. 3 patients diagnosed respectively with X-linked severe combined immunodeficiency, anhidrotic ectodermal dysplasia with immune deficiency and chronic granulomatous disease had MTB complex infection: disseminated Bacillus Calmette-Guerin infection in the first patient; cutaneous tuberculosis in the second and TB meningitis in the third. The median age at symptoms' onset was 9 months (range 6, 15). In 2 patients, MTB complex infection occurred before an established diagnosis of IEI and associated concomitant pulmonary tuberculosis. Diagnosis was confirmed by identification of the MTB complex from microbiological culture in 2 patients and by positive PCR in one patient. Patients received a three-drug up to five-drug regimen for a median of 6 months. Treatment was curative in one patient.

Learning Points/Discussion: MTB complex infections are potential first disease manifestations in children with IEI and should prompt immunological evaluation. Furthermore, MTB infection arised as disease complication delays access to potential curative treatment, i.e. early hematopoietic stem cell transplantation (HSCT).

EP104 / #446

Topic: AS04. Immunology & compromised host / AS04.d. Infections in immunocompromised/immunodeficient patients

FAVIPIRAVIR INDUCES LETHAL MUTAGENESIS IN NOROVIRUS: A PROMISING TREATMENT FOR CHRONICALLY INFECTED IMMUNOCOMPROMISED PATIENTS

E-Posters

E-POSTER VIEWING

Alexandra Kreins^{1,2}, Juanita Pang², Emma Roux³, Iek Cheng², Reem Mohammed^{4,5}, Austen Worth¹, Caroline Solas⁶, Joseph Standing², Joana Rocha-Pereira³, Graham Davies¹, Judith Breuer²
¹Great Ormond Street Hospital NHS Foundation Trust, Immunology, London, United Kingdom, ²UCL Great Ormond Street Institute for Child Health, Infection, Immunity And Inflammation Research Department, London, United Kingdom, ³KU Leuven, Department Of Microbiology, Immunology And Transplantation, Rega Institute, Laboratory Of Virology And Chemotherapy, Leuven, Belgium, ⁴King Faisal Specialist Hospital & Research Center, Department Of Pediatrics, Division Of Allergy & Immunology, Riyadh, Saudi Arabia, ⁵Alfaisal University, College Of Medicine, Riyadh, Saudi Arabia, ⁶Aix-Marseille University, Unite Des Virus Emergents Ird 190, Inserm 1207, Marseille, France

Backgrounds: In immunocompromised hosts, human norovirus (HuNoV) infection is responsible for severe disease, characterised by chronic diarrhoea, failure to thrive, parenteral nutrition (PN)-dependency and increased mortality. In absence of approved therapeutics against HuNoVs, compassionate use of repurposed, broad-spectrum anti-virals has been pursued in immunodeficient patients. Favipiravir, a nucleoside analogue acting as an inhibitor of the RNA-dependent RNA polymerase (RdRp) of RNA viruses, induces an accumulation of transitional mutations in the viral genome during replication. Beyond a tolerated mutation threshold, this can lead to lethal mutagenesis.

Methods: We treated a paediatric patient with severe combined immunodeficiency and life-threatening HuNoV infection with favipiravir in combination with nitazoxanide. Over a one-year treatment period, clinical, pharmacokinetic and virological monitoring was conducted, including viral deep sequencing and phylogenetic analysis. The impact of drug-induced mutations on infectivity was assessed in zebrafish larvae. We compared the outcomes with those in other treated and untreated immunodeficient patients with chronic HuNoV infections.

Results: In the presence of putative therapeutic favipiravir levels, even though viral loads remained high, clinical improvement was seen, including progressive weight gain and PN discontinuation. In comparison to HuNoV from untreated patients, sequencing documented favipiravir-induced mutation bias with accumulation of C to T and G to A mutations, including RdRp mutations that are predicted to favour favipiravir resistance. Despite the dominance of apparently drug-resistant clones over time, loss of infectivity with an increased ID₅₀ was seen in zebrafish inoculated with patient stool samples.

Conclusions/Learning Points: Favipiravir-induced mutagenesis across the HuNoV genome results in clinical improvement for chronically infected immunodeficient patients because of dose-dependent loss of HuNoV infectivity, despite the presence of mutations conferring drug resistance. This supports the use of RdRp inhibitors for the treatment of RNA viral infections, including SARS-CoV-2.

EP105 / #1824

Topic: *AS04. Immunology & compromised host / AS04.d. Infections in immunocompromised/ immunodeficient patients*

PERIPHERAL FACIAL NERVE PALSY (PFNP) AS A SEQUELAE OF VZV PRIMARY INFECTION IN A 12-YEAR OLD BOY

E-Posters

E-POSTER VIEWING

Liza Lea Lah

General Hospital Celje, Paediatric Unit, Ljubljana, Slovenia

Title of Case: PERIPHERAL FACIAL NERVE PALSY (PFNP) AS A SEQUELAE OF VZV PRIMARY INFECTION IN A 12-YEAR OLD BOY

Background: A 12-year-old boy was admitted 10 days after a vesicular rash had appeared on his skin. He had been in contact with his sister, who had Varicella a week before. He had a low grade fever for two days and few vesicles on his head and trunk. Five days after the vesicular rash had resolved a PFNP grade IV on the House-Brackmann (HB) scale was noticed.

Case Presentation Summary:

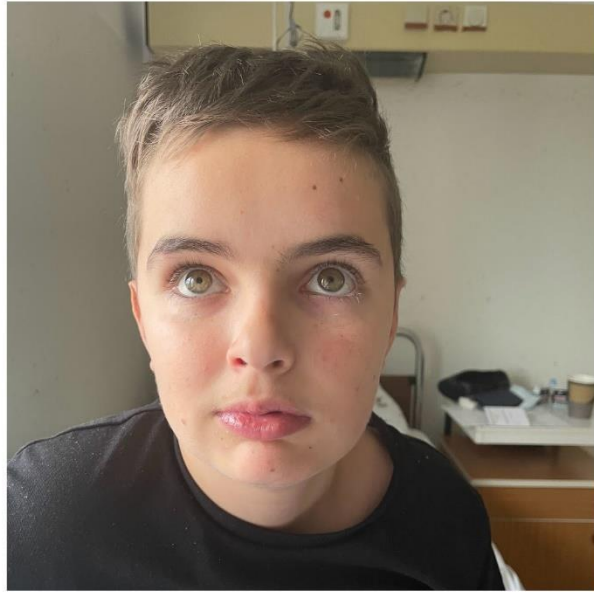

A lumbar puncture was performed (leukocytes 0, protein 0,35g/dl, normal serum/CSF glucose ratio). There were no bacteria or viruses detected in the brain fluid. There were no specific antibodies to *Borrelia burgdorferi* (BB) detected in the serum or CSF. There was no intrathecal synthesis of specific antibodies for BB or VZV detected. Since the PFNP was associated temporarily with VZV infection, we prescribed valacyclovir (1000mg tid po) for 10 days. Intensive physiotherapy of the facial muscles was initiated.

Learning Points/Discussion: On follow up, regeneration of the upper branch of the PFN is complete, while there is still slight asymmetry in the lower branches (HB grade II). A significant level of VZV IgG antibody had appeared in response to his infection. There is no seroconversion of antibodies to *Borrelia burgdorferi*.



Better outcomes are reported in patients treated with antivirals. Steroids are not associated with better outcomes in cases of PFNP associated with Varicella. This boy has a chronic leukopenia with lower levels of CD8 lymphocytes and has been seeing an immunologist since age four, but has no specific diagnosis. He has had no previous episodes of serious viral or other infections, no observed side effects after routine vaccination.

EP106 / #1447

Topic: AS04. Immunology & compromised host / AS04.d. Infections in immunocompromised/ immunodeficient patients

CARBAPENEM-RESISTANT ENTEROBACTERIACEAE BLOODSTREAM INFECTIONS IN CHILDREN UNDERGOING HAEMATOPOIETIC STEM CELL TRANSPLANTATION

E-Posters

E-POSTER VIEWING

Takwa Lamouchi, Samia Rekaya

Centre National de Greffe de Moelle Osseuse de Tunis, Immuno-hématologie Et Oncologie Pédiatriques, Tunis, Tunisia

Backgrounds: The use of empirical broad spectrum antibiotics in children receiving haematopoietic stem cell transplant (HSCT) has resulted in the emergence of resistant bacteria. Herein we describe the incidence and morbidity of Carbapenem resistant bacterial bloodstream infections (BSI) in children undergoing HSCT.

Methods: We conducted a monocentric cross sectional retrospective study that included all children aged three months to 14 years old and who received an HSCT between April 2018 and November 2021 in Tunisia. We looked into bloodstream infections and bacteremia in patients from the first 100 days post-HSCT. BSI were defined as the presence of viable micro-organism in the bloodstream associated to a systemic inflammatory response characterized by the alteration of clinical or laboratory parameters.

Results: We enrolled a total of 105 patients who underwent 107 allogeneic HSCT. All of them received gut decontamination with non-absorbed antibiotics: Gentamicin and Colimycin. No systemic antibacterial prophylaxis was given. The number of patients who developed at least one episode of BSI or bacteremia by day 100 post-HSCT was 31 (29.5%). Among them, five patients presented BSI with Carbapenem resistant Enterobacteriaceae (CRE): it was Pseudomonas in four patients and Klebsiella in one patient. All five patients received broad spectrum antibiotics and four received Imipenem for at least 15 days during the month preceding the CRE infection. The underlying diseases were: lymphoblastic leukemia (1), bone marrow failure (2) and severe combined immune deficiencies(2). Two out those five patients died due to septic shock. Resistant bacteria was responsible for 25% of total infection related deaths within 100 days post-HSCT.

Conclusions/Learning Points: CRE infections have been increasing in pediatric haematological unit due to empiric use of broad spectrum antibiotics. These infections are associated with high mortality rates especially in immunocompromised patients.

EP107 / #1031

Topic: AS04. Immunology & compromised host / AS04.d. Infections in immunocompromised/immunodeficient patients

EARLY INVASIVE LISTERIOSIS AFTER CARDIAC TRANSPLANTATION IN A 11-YEAR-OLD BOY

E-Posters

E-POSTER VIEWING

Stefania Mercadante¹, Maia De Luca², Lorenza Romani², Laura Cursi², Sara Chiurchiù², Martina Di Giuseppe², Francesca Ippolita Calò Carducci², Laura Lancella², Paola Bernaschi³, Rachele Adoriso⁴, Antonio Amodeo⁵, Cristiana Garisto⁶, Tiziana Fragasso⁶, Luca Di Chiara⁶

¹Bambino Gesù Children's Hospital, Pediatric Department, Rome, Italy, ²Bambino Gesù Children's Hospital, IRCCS, Immunology And Infectious Diseases Unit, Rome, Italy, ³Bambino Gesù Children's Hospital, Unit Of Microbiology, Rome, Italy, ⁴Bambino Gesù Children's Hospital, Heart Failure Clinic-heart Failure, Heart Transplant, Mechanical Circulatory Support Unit, Department Of Pediatric Cardiology And Cardiac Surgery, Heart And Lung Transplant, Rome, Italy, ⁵Bambino Gesù Children's Hospital, Department Of Paediatric Cardiology And Cardiac Surgery, Rome, Italy, ⁶Bambino Gesù Children's Hospital, Pediatric Cardiac Anesthesia/intensive Care Unit, Department Of Pediatric Cardiology And Cardiac Surgery, Rome, Italy

Title of Case: Early invasive listeriosis after cardiac transplantation in a 11-year-old boy

Background: *Listeria Monocytogenes* is a Gram-plus rod transmitted via oro-fecal route, mainly through contaminated food. Older people, immunocompromised patients and neonates are at increased risk for invasive disease including meningitis, meningoencephalitis and bacteriemia. We present a case of *Listeria* meningoencephalitis in a paediatric heart transplant recipient.

Case Presentation Summary: A 11-year-old male underwent cardiac transplantation for acute myocarditis. The immunosuppressive therapy consisted of Tacrolimus, mycophenolate mofetil (MMF), rapidly tapered steroids and induction with polyclonal T-cell-depleting antibodies. On day 9 post-transplant the boy developed fever, leucocytosis and elevated C-reactive protein. His conditions rapidly worsened to septic shock. The disease course was complicated by acute rhabdomyolysis with consequent renal failure. *Listeria monocytogenes* was isolated from blood cultures. Lumbar puncture showed opalescent cerebrospinal fluid (CSF), 723 WBC/mm³ (0-5), glucose 5 mg/dL (60-80), total protein 142 mg/dL (< 45). Multiplex Panel PCR for meningitis/encephalitis on CSF resulted positive for *Listeria Monocytogenes*. CSF cultures yielded no growth. Cerebral RM showed inflammatory involvement of the pial meninges. Immediate antibiotic treatment was started with meropenem and gentamicin. The response to the therapy was good, achieving sterilization of blood cultures and normalization of CSF values. Gentamicin was discontinued on day 14 of therapy and he received a total of five weeks of meropenem.

Learning Points/Discussion: Although immunocompromised individuals are susceptible to invasive forms of listeriosis, there are very few cases reported among heart transplanted children. In our patient we hypothesize a community-acquired infection through contaminated food. Rhabdomyolysis may have been related to the infection, as rarely described in literature.

Topic: AS04. Immunology & compromised host / AS04.d. Infections in immunocompromised/immunodeficient patients

INVASIVE PNEUMOCOCCAL DISEASE IN HIGH-RISK CHILDREN: A 10-YEAR RETROSPECTIVE STUDY

E-Posters

E-POSTER VIEWING

Jacqui Van Warmerdam¹, Aaron Campigotto^{2,3}, Ari Bitnun^{3,4}, Georgina Macdougall⁴, Melanie Kirby-Allen^{3,5}, Blake Papsin^{3,6}, Allison McGeer⁷, Upton Allen^{3,4,8}, Shaun Morris^{3,4,8,9}

¹University of Toronto, Faculty Of Medicine, Toronto, Canada, ²The Hospital for Sick Children, Microbiology, Toronto, Canada, ³University of Toronto, Pediatrics, Toronto, Canada, ⁴The Hospital for Sick Children, Infectious Disease, Toronto, Canada, ⁵The Hospital for Sick Children, Haematology, Toronto, Canada, ⁶The Hospital for Sick Children, Otorhinolaryngology, Toronto, Canada, ⁷Mount Sinai Hospital, Infectious Disease, Toronto, Canada, ⁸The Hospital for Sick Children, Child Health Evaluative Sciences, Toronto, Canada, ⁹University of Toronto, Dalla Lana School Of Public Health, Toronto, Canada

Backgrounds: Despite availability of conjugate pneumococcal vaccines, children with high-risk conditions remain vulnerable to invasive pneumococcal disease (IPD). This study sought to describe IPD prevalence, vaccination, and outcomes among high-risk children.

Methods: We used ICD10 discharge codes to identify patients hospitalized for IPD at a large pediatric hospital from January 1, 2009, to December 31, 2018. Patients were considered high-risk if they had: primary immunodeficiency, asplenia, transplant, active malignancy, sickle cell disease, cochlear implant, nephrotic syndrome, chronic lung disease, cerebrospinal fluid leak, HIV, or used immunosuppressive therapy.

Results: Over the 10-year period, 94 high-risk patients were hospitalized for IPD. The most common high-risk conditions included malignancy (n=33, 35%), solid-organ or bone marrow transplant (n=17, 18%), and sickle cell disease (n=14, 15%). Bacteremia was the most common presentation (n=81, 86%) followed by pneumonia (n=23, 25%), and meningitis (n=9, 10%). No deaths occurred. Of 66 patients with known pneumococcal vaccination status, 15 (23%) were unvaccinated, and 51 (77%) received at least one vaccine dose. All recommended PCV doses were received by 20 children. Only three children received PPSV23. Of 20 children with no or partial immunization, 70% (14) of IPD episodes were due to vaccine-preventable serotypes. Of 66 known IPD serotypes, 17% (n=11) were covered by PCV13, 39% (n=26) covered by PPSV23, and 39% (n=26) were a non-vaccine serotype.

Conclusions/Learning Points: Despite availability of effective pneumococcal vaccines, IPD persists among children with underlying high-risk conditions. Improving vaccination coverage could significantly reduce IPD, as most episodes were due to vaccine-preventable serotypes in unimmunized or partially immunized patients.

EP109 / #1009

Topic: AS04. Immunology & compromised host / AS04.d. Infections in immunocompromised/ immunodeficient patients

«THINK ZEBRA»: A SYSTEMATIC REVIEW OF PRIMARY INFECTIOUS SYMPTOMS IN PEDIATRIC PATIENTS WITH PRIMARY IMMUNODEFICIENCIES

E-Posters

E-POSTER VIEWING

Maria Palyvou¹, Alexandra Soldatou²

¹Patras Medical School, University of Patras, Department Of Paediatrics, Patras, Greece, ²Athens Medical School, University of Athens, Department Of Paediatrics, Athens, Greece

Backgrounds: Primary immunodeficiencies are genetic disorders of the immune system that lead to life-threatening infections. The object of this systematic review was to identify the primary infectious manifestations of primary immunodeficiency that lead pediatric patients to health care facilities.

Methods: A literature search was conducted in the databases: MEDLINE and Google Scholar, limited to the last 20 years and in English language. Keywords included children, infants or adolescents with primary immunodeficiency or disorders of innate immunity as well as first screening or recognition of primary immunodeficiency.

Results: Two independent researchers identified 1352 articles, of which 1116 were excluded from the title, 116 were excluded from the abstract, and they jointly agreed to include 49 articles. Recurrent bacterial infections of the respiratory tract were the most common manifestation of primary immunodeficiency, signifying underlying disorders of humoral immunity and complement deficiencies. In the investigation of patients with skin abscesses from *St. aureus* or *Candida*, hyper-IgE syndrome and chronic granulomatous disease should be considered. Invasive infections by opportunistic pathogens indicated disorders of innate immunity, complement deficiencies or combined immunodeficiency. Combined immunodeficiency was also responsible for invasive infections due to an attenuated vaccine strain.

Conclusions/Learning Points: Since infectious clinical manifestations were significant for the identification of an underlying primary immunodeficiency disease, prompt and targeted immune workup might be crucial for the patient's survival.

EP111 / #476

Topic: AS04. Immunology & compromised host / AS04.d. Infections in immunocompromised/ immunodeficient patients

PNEUMOCYSTIS JIROVECI PNEUMONIA IN CHILDREN – A RETROSPECTIVE STUDY IN A SINGLE CENTRE OVER NINE YEARS

E-Posters

E-POSTER VIEWING

Xue Fen Valerie Seah¹, Natalie Woon Hui Tan^{2,3,4,5}, Chia Yin Chong^{2,3,4,5}

¹KK Women's and Children's Hospital, Pharmacy, Singapore, Singapore, ²KK Women's and Children's Hospital, Pediatric Medicine, Infectious Diseases Service, Singapore, Singapore, ³National University of Singapore, Yong Loo Lin School Of Medicine, Singapore, Singapore, ⁴National University of Singapore, Duke-national University Of Singapore Medical School, Singapore, Singapore, ⁵Nanyang Technological University, Lee Kong Chian School Of Medicine, Singapore, Singapore

Backgrounds: Pneumocystis jirovecii pneumonia (PJP) is a life-threatening condition especially in the immunocompromised. However, few studies have evaluated the clinical characteristics associated with PJP and outcomes in children. We aim to review the features and outcomes of PJP cases in our setting.

Methods: This is a retrospective study including all pediatric patients (≤ 18 years) with PJP admitted to a tertiary pediatric hospital (1 January 2009 to 30 October 2017) with acute pneumonia and presumptive or definitive P. jirovecii detected in bronchoalveolar lavage or tracheal aspirate using methenamine silver or direct antibody fluorescence staining, or Real-Time Polymerase Chain Reaction.

Results: Fourteen children with PJP were included, of which 7 had definitive PJP diagnoses and 4 were identified to have human immunodeficiency virus (HIV) infection upon presentation. Two children were on long duration of steroids (one with infantile spasms and 2.5 months of steroids use, another with auto-inflammatory disease of unknown cause who received 3.5 months of tapering steroids and Anakinra and was later diagnosed to have combined immunodeficiency). All were treated with IV/PO trimethoprim/sulfamethoxazole for 21 days, of which 10 (71.4%) received adjuvant steroids. One child (7.1%) with HIV infection eventually demised from disseminated Cytomegalovirus infection.

| TABLE: Clinical characteristics and outcomes of 14 children with <i>Pneumocystis jirovecii</i> pneumonia (PJP) | | |
|---|----------|--|
| Characteristics | n | (%) |
| Male | 10 | (71.4) |
| Age (years; median, SD and range) | 0.6 | (5.5, 0.2-15) |
| Underlying diseases | | |
| Primary immunodeficiency (3: Severe Combined Immunodeficiency, of which 2 was newly diagnosed; 1 each: HyperIgM syndrome, newly diagnosed immunodeficiency for investigation) | 5 | (35.7) |
| Haematology-oncology (2: T-cell Acute Lymphoblastic Leukaemia (ALL), 1 each: Neuroblastoma, Medulloblastoma) | 4 | (28.6) |
| Human immunodeficiency virus (HIV) infection | 4 | (28.6) |
| Neurology (Infantile spasms) | 1 | (7.1) |
| Steroids use | 2 | (14.3) |
| PJP Prophylaxis | | |
| Oral trimethoprim/sulfamethoxazole twice weekly (1: HyperIgM syndrome, 2: ALL) | 3* | (21.4) *1 ALL patient reported non-compliance |
| None | 11 | (78.6) |
| Clinical features and outcomes | | |
| Definitive PJP diagnosis | 7 | (50) |
| Intensive care and mechanical ventilation required | 8 | (57.1) |
| Co-infection (bacterial/ viral/ other fungal) | 12 | (85.7) |
| Mortality | 1 | (7.1) |

Conclusions/Learning Points: Majority of our non-HIV patients developed PJP while not on prophylaxis. Identification of high-risk patients who may get benefit from primary or secondary PJP prophylaxis is important, such as those on long duration of steroid treatment and newly diagnosed immunodeficiency.

EP112 / #862

Topic: AS04. Immunology & compromised host / AS04.d. Infections in immunocompromised/ immunodeficient patients

DISSEMINATED BACILLE CALMETTE–GUERIN DISEASE (BCGOSIS) DUE TO A NOVEL LOSS-OF-FUNCTION MUTATION IN STAT1

E-Posters

E-POSTER VIEWING

Saho Shima¹, Yuhei Tanaka², Atsushi Miyake³, Kenji Gotoh⁴, Ryuta Nishikomori²

¹Kurume University School of Medicine, Pediatrics And Child Health, Kurume-city, Fukuoka, Japan, ²Kurume University of Medicine, The Department Of Pediatrics And Child Health, Kurume City, Japan, ³Kurume university school of medicine, Pediatrics And Child Health, Kurume city, Fukuoka, Japan, ⁴Kurume University School of Medicine, The Department Of Infection Control And Prevention, Kurume, Japan

Title of Case: DISSEMINATED BACILLE CALMETTE–GUERIN DISEASE (BCGosis) DUE TO A NOVEL LOSS-OF-FUNCTION MUTATION IN STAT1

Background: Bacille Calmette–Guerin (BCG) vaccine has been recommended to prevent against disseminated and meningeal tuberculosis in tuberculosis incidence countries, while it has been known to have a risk of complications in patients with primary immunodeficiency diseases (PID). BCG vaccine is one of the routine vaccination in JAPAN.

Case Presentation Summary: An 8-month-old boy received the BCG vaccination on his left upper arm at the age of 5 month. Since 7 months of age, he presented with abnormal erythema at the BCG scar, left axillary lymphadenopathy and fever. He was treated with various antibacterial agents, but the fever persisted and the response was poor. Upon detailed examination, a CT scan revealed a shadow of a small nodule in the left lung. Furthermore, Mycobacterium bovis BCG was detected by polymerase chain reaction (PCR) testing of axillary lymph node tissue. Based on these findings, BCGosis was diagnosed. Therapy with standard doses of isoniazid and Rifampicin was initiated, and an immunological workup for underlying PID was performed. Targeted resequencing of Mendelian susceptibility to mycobacterial disease (MSMD) revealed a unreported heterozygous variant, c.1762C > T, in the Signal transducer and activator of transcription 1 (STAT1) gene (NM_007315.4) resulting in the nonconservative change p.Arg588Cys. Furthermore, we identified that this mutation leads loss-of-function (LOF) in STAT1.

Learning Points/Discussion: It is known that many of the onset symptoms in patients with STAT1 LOF are caused by mycobacterial infections. In BCG introduced countries, the most common first manifestations of MSMD are caused by infection with BCG strains. Therefore, in such a case presented symptoms associated with BCG vaccination, genetic testing should be early considered.

EP113 / #1479

Topic: AS04. Immunology & compromised host / AS04.d. Infections in immunocompromised/immunodeficient patients

ANTI-N-METHYL-D-ASPARTATE RECEPTOR (NMDAR) ENCEPHALITIS TREATMENT. RISKS OR BENEFITS?

E-Posters

E-POSTER VIEWING

Maria Soares¹, Ana Lemos¹, Rita Silva², Catarina Santos³, Anaxore Casimiro⁴, Maria Brito¹

¹Hospital Dona Estefânia, Centro Hospitalar Universitário Lisboa Central, E.P.E, Unidade De Infeciologia Pediátrica, Lisboa, Portugal, ²Hospital Dona Estefânia, Centro Hospitalar Universitário Lisboa Central, E.P.E, Unidade De Neurologia Pediátrica, Lisboa, Portugal, ³Hospital Dona Estefânia, Centro Hospitalar Universitário Lisboa Central, E.P.E, Serviço De Pedopsiquiatria, Lisboa, Portugal, ⁴Hospital Dona Estefânia, Centro Hospitalar Universitário Lisboa Central, E.P.E, Unidade De Cuidados Intensivos, Lisboa, Portugal

Title of Case: Anti-N-methyl-D-aspartate receptor (NMDAr) encephalitis treatment. Risks or Benefits?

Background: Anti-NMDAr encephalitis is an immune-mediated disease. A typical presentation includes acute neuropsychiatric features, abnormal behavior, movement disorder, and autonomic instability. Autoantibodies against NMDA receptors in the brain can be created following triggering mechanisms such as infectious agents and tumors.

Case Presentation Summary: A 17-year-old teenager with neuropsychiatric disorder, seizures, fluctuating consciousness and dysautonomia, required intensive care and mechanical ventilation. It was detected anti-NMDAr in the blood and cerebrospinal fluid. An abdominal ultrasound identified a left ovarian teratoma. A surgical excision was performed, and the first line treatment of Brain Works protocol was started with intravenous immunoglobulin, corticotherapy and plasmapheresis. Despite this, there was no clinical improvement. On the 13th day of hospitalization, the condition was complicated by *Acinetobacter baumannii* pneumonia, which motivated a delay of second line therapy with rituximab, that was started only on 38th day. The clinical response was slow and after the fourth dose there was a partial clinical improvement and cyclophosphamide was started. After the first cycle, it was observed leukopenia (290/uL) with severe neutropenia (69/uL) complicated by nosocomial pneumonia, and after the second cycle, alopecia, dysgeusia, constipation, macrocytosis and sepsis without an identified agent. Therefore, cyclophosphamide was suspended, maintaining monthly immunoglobulin and daily prednisolone. After 153 days of treatment, the patient revealed partial clinical improvement with multiple neurological sequelae.

Learning Points/Discussion: The neurological benefit of immunomodulatory therapy must be balanced with the risk of opportunistic infections and noninfectious complications. There are limited data for the management of this therapy, wherefore its maintenance must be integrated into a multidisciplinary discussion, involving the patient and his family.

EP114 / #1049

Topic: *AS04. Immunology & compromised host / AS04.d. Infections in immunocompromised/ immunodeficient patients*

ANTIBODIES TO VACCINE-PREVENTABLE DISEASES IN CHILDREN WITH PRIMARY IMMUNODEFICIENCY ON INTRAVENOUS IMMUNOGLOBULIN TREATMENT

E-Posters

E-POSTER VIEWING

Alla Volokha, Anastasia Bondarenko, Anna Lisovska

Shupyk National Healthcare University of Ukraine, Pediatric Infectious Diseases And Pediatric Immunology, Kyiv, Ukraine

Backgrounds: Children with primary immunodeficiency are at increased risk of infectious diseases caused by vaccine preventable pathogens. Protection against vaccine-preventable diseases is important in immunodeficient patients because of low coverage vaccination in Ukraine. We report the data of protective immunity against infectious diseases in children with PID on intravenous immunoglobulin replacement therapy.

Methods: We studied trough serum level of specific IgG antibodies against measles, rubella, poliomyelitis, hepatitis B, diphtheria and tetanus in 37 children with PID on replacement therapy with intravenous immunoglobulin compared to 29 healthy controls of similar age.

Results: All patients with PID presented protective levels of antibodies specific for measles, rubella, tetanus and hepatitis B. Some patients had suboptimal diphtheria antibody levels in patient and control groups. It was found that anti-Polio antibody concentration in our patients were found to be lower than assay's protective cut-off concentration in 64,9% of the individuals, compared with control group - 41,4%. In the healthy control group the mean value of anti-Measles antibodies was significantly higher (9289 ± 3773 IU/ml) than in PID patients (1140 ± 174 IU/ml). There was no significant difference between means of patient group and healthy controls' serum levels of anti-Tetanus, anti-Diphtheria, anti-Rubella, anti-Polio and anti-Hbs antibodies. Tetanus and diphtheria toxoid antibodies titer were very variable in both controls and PID patient groups

Conclusions/Learning Points: The PID patients receiving intravenous immunoglobulin replacement therapy are protected against majority of vaccine-preventable diseases except poliomyelitis. A trough levels of specific antibodies probably depends on the level of specific immunoglobulins in plasma from adult donors

EP115 / #600

Topic: AS05. Global health / AS05.a. Zoonosis, vector-borne and emerging infections

SEVERE MEDITERRANEAN SPOTTED FEVER IN A CHILD

E-Posters

E-POSTER VIEWING

Inês Almeida¹, Marta Novo¹, Luísa Gaspar², Marisol Anselmo³, Guida Gama¹, João Rosa², Mariana Reis¹, Joana Capela¹

¹Centro Hospitalar Universitário do Algarve, Serviço De Pediatria, Faro, Portugal, ²Centro Hospitalar Universitário do Algarve, Neonatal Intensive Care Unit, Faro, Portugal, ³Hospital Particular do Algarve, Pediatrics And Neonatal Unit, Faro, Portugal

Title of Case: SEVERE MEDITERRANEAN SPOTTED FEVER IN A CHILD

Background: Mediterranean spotted fever (MSF) is mostly a benign and self-limited disease, mainly in children. Nonetheless, severe systemic manifestations have been reported and are often explained by a delay in diagnosis. We present a case of distributive shock occurring in a 7-year-old Portuguese boy as a complication of MSF, during summertime.

Case Presentation Summary: A male child, with medical history of diabetes mellitus type one with insulin infusion pump (IIP), was admitted in pediatric intensive care due to prostration, hypoxemia and hypotension. He presented a four-day fever, myalgias, generalized maculo-papular rash, involving palms and plants, and palpable hepatosplenomegaly. The analytical study showed pancytopenia, coagulopathy, increased markers of myocardial injury, elevated transaminases and PCR. An interview with the mother uncovered a recent manipulation of the IIP and recent history of excision of plantar cutaneous lesion, initially thought to be a plantar wart. Initial diagnosis hypothesis of toxic shock syndrome, MSF or MIS-C were considered with the patient having started large spectrum antibiotherapy (azithromycin, ceftriaxone and clindamycin), immunoglobulin, corticotherapy and vasoactive drugs, with clinical improvement. Optimal glycemic control with IIP. On the sixth day of hospitalization, was noticed resurgence of fever and rash after suspending azithromycin. Thus, a more probable diagnosis of Rickettsial infection was assumed, later confirmed by serology and PCR. The patient was then treated with doxycycline, with a complete recovery.

Learning Points/Discussion: Although severe multi-organ manifestation is a rare and severe clinical manifestation of this illness, it is important to recognize *Rickettsia conorii* as a possible etiological agent in children. Doxycycline remains the treatment of choice, principally in immunocompromised patients and with severe disease. IIP proved to be effective even in a context of a severe infection.

Topic: AS05. Global health / AS05.a. Zoonosis, vector-borne and emerging infections

SEROLOGICAL EVIDENCE OF DENGUE VIRUS AND ORTHOHANTAVIRUS INFECTIONS AMONG PREGNANT WOMEN IN BARBADOS

E-Posters

E-POSTER VIEWING

Kirk Douglas¹, Marquita Gittens-St. Hilaire², Alafia Samuels³

¹University of the West Indies, Cave Hill Campus, Centre For Biosecurity Studies, Cave Hill, Barbados, ²University of the West Indies, Cave Hill Campus, Faculty Of Medical Sciences, cave hill, Barbados, ³University of the West Indies, Cave Hill Campus, George Alleyne Chronic Disease Research Centre, cave hill, Barbados

Backgrounds: Hantavirus and dengue virus (DENV) infections lead to diseases causing economic and public health concerns globally. These are RNA viruses which infect immune systems cells including monocytes, macrophages and dendritic cells resulting in similar clinical haemorrhagic signs and symptoms. Using a retrospective case analysis of pregnant dengue and hantavirus infected patients with clinical reports and compatible clinical laboratory tests during pregnancy, we report the first serological evidence of dengue and hantavirus infections among pregnant women in Barbados and in the Caribbean.

Methods: Retrospectively (2008-2016) a list of pregnant DENV- and hantavirus infected cases with clinical reports and compatible clinical laboratory testing was identified. Diagnosis of DENV infection was confirmed either by DENV-specific real-time reverse transcriptase polymerase chain reaction (rRT-PCR), or non-structural protein 1 (NS1) antigen or enzyme linked immunosorbent assay (ELISA) tests. Hantavirus infection was confirmed using ELISA tests followed by confirmatory testing with immunofluorescent assays (IFA), immunochromatographic (ICG) tests, and pseudotype focus reduction neutralization tests (pFRNT).

Results: Six (6) hantavirus- and one (1) DENV-infected pregnant cases were identified which displayed some anomalous clinical laboratory results including stage 1 hypertension, renal involvement, elevated liver enzyme levels, low haematocrit, elevated white blood cell (WBC) levels and premature birth. The DENV-infected pregnant patient also possessed serological evidence of hantavirus infection indicating a potential co-infection of DENV and hantavirus.

Conclusions/Learning Points: This study presents the first clinical hantavirus and DENV infections among pregnant women in the Caribbean and a dengue/hantavirus co-infection. Following hantavirus infection, possible complications of pregnancy can occur including pregnancy induced pathologies such as acute fatty liver of pregnancy (AFLP) with severe renal failure and haemolysis, elevated liver enzymes and low platelet count (HELLP) syndrome, and also pre-term birth and low birth weights.

SUCCESSFUL TREATMENT OF FASCIOLA HEPATICA WITH METRONIDAZOLE IN A CHILD

E-Posters

E-POSTER VIEWING

Zeynep Ergenc¹, Eda Kepenekli¹, Nurhayat Yakut¹, Utku Batu², Ozge Yapici³, Engin Tutar⁴

¹Marmara University School of Medicine, Pediatric Infectious Diseases, Istanbul, Turkey, ²Marmara University School of Medicine, Pediatrics, Istanbul, Turkey, ³Marmara University School of Medicine, Radiology, Istanbul, Turkey, ⁴Marmara University School of Medicine, Pediatric Gastroenterology, Istanbul, Turkey

Title of Case: Successful Treatment of Fasciola Hepatica With Metronidazole in a Child

Background: Fasciola hepatica is a zoonotic liver trematode that usually causes infection in cattle and sheep, and is transmitted to humans by consuming water and aquatic plants contaminated with metacercariae. Triclabendazole is the first-line therapy of Fascioliasis. However, as it is not an easily accessible drug in many countries, it reveals a quest for alternative therapies. Here we present a case of pediatric fascioliasis successfully treated with metronidazole.

Case Presentation Summary: A 10-year-old asymptomatic boy from a rural area was referred to our clinic for further evaluation of his peripheral eosinophilia. No findings except hepatomegaly were detected on physical examination. Laboratory tests revealed marked eosinophilia (31%) with a normal total IgE level. Abdominal ultrasonography and abdominal Magnetic Resonance Imaging (MRI), showed hepatomegaly with a lesion and lymphadenopathy at liver segment 6.

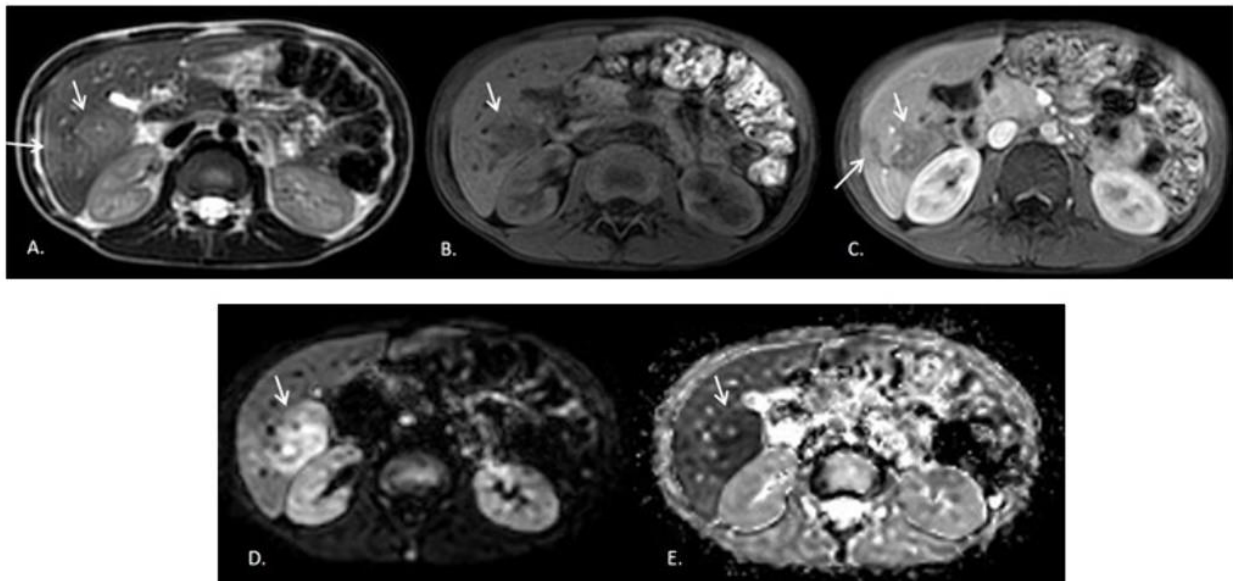

(Figure.1) Fasciola serology could not be applied due to technical insufficiency. Stool examination was negative for Fasciola eggs. An ultrasound-guided liver tru-cut biopsy was performed and, eosinophil-rich abscess formation was observed around the necrosis supporting the diagnosis of Fasciola hepatica infection. The patient was diagnosed with Fascioliasis with clinical, radiological, and pathological findings. Due to the inaccessibility of triclabendazole, 1.5 g/day of metronidazole treatment was initiated. After 3 weeks of therapy, eosinophilia returned to normal and abdominal ultrasonography and MRI showed complete resolution of the lesions. During 1 year of follow-up, he was asymptomatic with no eosinophilia or new hepatic lesions.

Learning Points/Discussion: The diagnosis and treatment of *Fasciola hepatica* is a challenging situation as it is rare in non-endemic areas and can be asymptomatic in patients. Metronidazole is a promising, well-tolerated treatment option for Fascioliasis in children.

EP119 / #432

Topic: AS05. Global health / AS05.a. Zoonosis, vector-borne and emerging infections

HEMORRHAGIC FEVER WITH RENAL SYNDROME IN CHILDREN

E-Posters

E-POSTER VIEWING

Sadie Namani¹, Remzije Koci², Ajete Aliu Bejta¹, Albina Ponosheci Bicaku¹, Rreze Hoti³

¹University of Prishtina, Medical Faculty, Prishtina, Kosovo, ²University Clinical Center of Kosovo, Pediatrics, Prishtina, Kosovo, ³University Clinical Center of Kosovo, Infectious Diseases Clinic, Prishtina, Kosovo

Title of Case: Hemorrhagic Fever with Renal Syndrome in Children

Background: Hemorrhagic fever with renal syndrome, also known as mice fever, is viral zoonotic infection caused by Hantaviruses from the family Bunyaviridae. The disease is endemic in Kosovo, although in recent years due to infection control measures, there were only sporadic cases. The disease is rarely reported in children and with leptospirosis are among the first causes to suspect of renal impairment in children. Children get infected mainly through inhalation of contaminated aerosols with rodent excretions.

Case Presentation Summary: A nine years old boy was admitted to our ward after having headache, chills, fever, vomiting, nosebleed, redness of the eyes and eyelid swelling. At admission, day 5th, he was conscious, intoxicated, afebrile, hypotensive, tachycardic, tachypneic, with conjunctival injection, with oedema and petechial rash. Blood analyses showed severe thrombocytopenia ($27 \times 10^3 \text{mm}^3$), leukocytosis, anemia, elevated liver enzymes (AST 70, ALT 144, LDH 1289), hypoalbuminemia 26 g/L and hypoproteinemia 43 g/L, electrolyte imbalance, CRP 36, PCT 29, albuminuria with erythrocyturia and leukocyturia, elevated urea 26 mmol/L and creatinine $303 \mu\text{mol/L}$ which returned to normal values after seven weeks. He came from rural area and during the summer he was living in mountain. The serology for hemorrhagic fever with Hantan virus was positive (IgG+ and IgM+), while serology for Crime-Congo hemorrhagic fever and Leptospirosis were negative. Treatment was based on fluid and electrolyte replacement, platelets suspensions, fresh frozen plasma, blood transfusion, antibiotics, low doses of steroids and oral ribavirin. In the oliguric phase due to non-improvement with forced diuresis and conservative management, the patient required 3 days of dialysis.

Learning Points/Discussion: In areas that used to be endemic regions, for every child with febrile illness and renal impairment, should be suspected hemorrhagic fever with renal syndrome.

EP120 / #404

Topic: AS05. Global health / AS05.a. Zoonosis, vector-borne and emerging infections

ACUTE Q FEVER AND PULMONARY TUBERCULOSIS IN AN ADOLESCENT – A CLINICAL CASE

E-Posters

E-POSTER VIEWING

Maria Sousa Dias¹, Joanna Ashworth², Mariana Meneses¹, Sofia Jordão³, Marco Pereira¹

¹Hospital Pedro Hispano, Pediatria, Matosinhos, Portugal, ²Centro Materno-Infantil do Norte, Pediatria, Porto, Portugal, ³Hospital Pedro Hispano, Infecçiology, Matosinhos, Portugal

Title of Case: ACUTE Q FEVER AND PULMONARY TUBERCULOSIS IN AN ADOLESCENT – A CLINICAL CASE

Background: In pediatric age groups, fever of unknown origin composes a diagnostic challenge due to its multiple possible etiologies. A high percentage of those cases is caused by infections. Our aim is to report the first pediatric case of concomitant acute Q fever and pulmonary tuberculosis, two diseases of challenging diagnosis in the absence of an evident epidemiological context.

Case Presentation Summary: A previously healthy twelve-year-old boy presented to the emergency department with a history of persistent fever and cough after two failed courses of outpatient oral antibiotics for pneumonia. His physical exam was normal. Blood tests showed significant leukocytosis and an elevated CRP and a chest radiograph complemented with ultrasonography found a right lower lobe consolidation with no complications. He was admitted with the diagnosis of non-resolving pneumonia, under ceftriaxone. Due to the persistence of fever after a week of hospitalization, despite expanded antibiotic coverage, the etiologic study was extended and found serologic evidence of acute infection by *Coxiella burnetti* and molecular and cultural positivity for *Mycobacterium tuberculosis* in bronchoalveolar lavage. After introduction of doxycycline, the patient became afebrile and his blood parameters normalized. He completed 14 days of this antibiotic therapy and, at discharge, was referred to the tuberculosis regional reference center for treatment and follow-up.

Learning Points/Discussion: In children, tuberculosis is a known cause of prolonged fever and high mortality. Diagnosis of Q fever is less prevalent, but its importance has been highly increasing. The clinical picture outlined here improved after pursuing the treatment for acute Q fever. Nevertheless, it is essential to emphasize the importance of identification and treatment for both infections.

EP121 / #950

Topic: AS05. Global health / AS05.a. Zoonosis, vector-borne and emerging infections

A 12YEAR EPIDEMIOLOGICAL STUDY OF VISCERAL LEISHMANIASIS AT A TERTIARY PEDIATRIC HOSPITAL

E-Posters

E-POSTER VIEWING

Maroula Tritzali, Maria Noni, Elizabeth- Barbara Tatsi, Vassiliki Syriopoulou, Athanasios Michos
“Aghia Sophia” Children’s Hospital, Division Of Infectious Diseases, First Department Of Pediatrics,
Medical School, National And Kapodistrian University Of Athens, Athens, Greece

Backgrounds: Visceral leishmaniasis (VL) is a systemic infection caused by protozoa of the genus Leishmania. It is endemic in the Mediterranean basin, where Leishmania infantum is the most frequent causative agent and transmission is via dogs through phlebotomine sandflies.

Methods: This is a retrospective study of children 0-16years old diagnosed with VL, in a 12-year period at the largest tertiary public hospital of Athens, Greece. Patients were grouped based on their age at the time of diagnosis.

Results: A total of 62 cases were recorded during 2008-2020 with a median age of 3.1 years. Splenomegaly (100%), fever (95.2%) and pallor (74.2%) were the most common presentations of the disease. Children >3 years old (group B), displayed more frequently pallor and malaise ($p=0.041$ and $p=0.017$, respectively), whereas children <3 years old (group A) cough and diarrhea ($p=0.036$ and $p=0.025$, respectively). The predominant laboratory abnormalities were anemia (98.4%), thrombocytopenia (88.7%) and elevated inflammatory markers (96.7%). Children in group B, exhibited more significant leukopenia ($p=0.048$), whereas children in group A increased liver enzymes ($p=0.025$). Ten patients developed secondary hemophagocytic lymphohistiocytosis syndrome and two others splenic nodules. Rapid rK39 strip test indicated anti-Leishmania antibodies in 87% of children and the majority of patients in whom indirect immunofluorescent antibody test was implemented, had positive results (95.8%). Bone marrow aspiration detected Leishmania parasites in 93.7% of the cases that was performed.

Conclusions/Learning Points: VL is still affecting children in our area, primarily younger than 4 years old and according to our data there might be age related differences in clinical and laboratory characteristics. In our study there was a high prevalence of positive serology that minimized the time interval from diagnosis to treatment, which is essentially the mainstay of disease control.

EP122 / #298

Topic: AS05. Global health / AS05.b. Tropical/parasite infections & travel medicine

ACUTE HEPATITIS A CO-INFECTION WITH SCRUB TYPHUS IN A 7 YEAR OLD BOY

E-Posters

E-POSTER VIEWING

Deepak Bhat, Gurdeep Singh Dhooria
Dayanand Medical College and Hospital, Pediatrics, Ludhiana, India

Title of Case: ACUTE HEPATITIS A COINFECTION WITH SCRUB TYPHUS IN A 7 YEAR OLD BOY

Background: Scrub typhus is now most commonly diagnosed rickettsial infection from Indian subcontinent and an important cause of acute undifferentiated fever in endemic areas. We report a 7 year old boy who was admitted as a case of acute viral hepatitis (hepatitis A) but due to persistence of fever was worked up for other causes of tropical fever and came positive for scrub typhus.

Case Presentation Summary: A 7 year old girl came to our emergency department with fever, pain abdomen and cough for 12 days, yellowish discoloration of eyes and urine for 7 days. On examination child was conscious, febrile (101.4 °F) with icterus present. Child was hemodynamically stable with tachypnea (respiratory rate-30/minute). On systemic examination, chest showed bilateral crepitations, per abdomen revealed liver enlarged 5 cm below right costal margin. Rest of the examination was normal. Child was initially managed as a case of tropical fever syndrome and started on 3rd generation cephalosporin. Initial investigations revealed deranged liver functions and anti HAV came out to be positive. Fever persisted. Patient's scrub serology also came positive for which oral azithromycin was added. Within next 3 days fever subsided and patient was discharged on oral medications.

Learning Points/Discussion: In a case of acute viral hepatitis if fever persists for significant days even after onset of jaundice ,suspect other causes of tropical fever syndrome and manage on lines of other etiologies till confirmed.

EP123 / #332

Topic: AS05. Global health / AS05.b. Tropical/parasite infections & travel medicine

COINFECTION WITH HEPATITIS A AND DENGUE FEVER COMPLICATED WITH E COLI SEPTICEMIA-A FATAL ASSOCIATION

E-Posters

E-POSTER VIEWING

Deepak Bhat, Gurdeep Singh Dhooria
Dayanand Medical College and Hospital, Pediatrics, Ludhiana, India

Title of Case: COINFECTION WITH HEPATITIS A AND DENGUE FEVER COMPLICATED WITH E COLI SEPTICEMIA-A FATAL ASSOCIATION

Background: Coinfection with dengue and hepatitis A is rare and challenging since their clinical features can be overlapping. These infections are self-limiting but can become complicated by subsequent bacterial sepsis. We report a fatal case of E Coli sepsis following a coinfection with hepatitis A and dengue fever.

Case Presentation Summary: A 14 year old adolescent boy was admitted with chief complaints of yellowish discoloration of eyes/urine for last 12 days,nausea/vomiting for last 15 days,reduced appetite for last 15 days,fever 15 days back which subsided in 4 days but again recurred 3 days prior to hospitalization. On arrival in emergency child had feeble peripheral pulses,hypotensive with blood pressure of 80/40 mmHg,prolonged capillary refill time,deep icterus.Child had a reddish hue over skin with epigastric tenderness.Child was given normal saline bolus at 20 ml/kg after which peripheral pulses improved.Child was managed initially as a suspected case of dengue shock with acute viral hepatitis. Patient's anti HAV IgM also came reactive .For dengue shock fluid was given as per WHO guidelines.Laboratory investigations revealed low platelet counts with raised hematocrit and a positive dengue serology.Child responded to fluid management.Initially fever subsided after admission and platelets showed an increase.But inspite of child recovering from dengue,platelets remained low and fever also persisted.Repeat blood culture sent on day 8 of hospitalization showed a growth of E coli sensitive only to aminoglycosides and tigecycline which were started but child's condition started deteriorating and developed multiorgan dysfunction and died on 18th day of hospitalization.

Learning Points/Discussion: coinfections have to be kept in mind whenever a well defined infectious disease shows uncommon features and gets complicated and prolonged.

EP124 / #974

Topic: AS05. Global health / AS05.b. Tropical/parasite infections & travel medicine

UNEXPECTED TRAVEL COMPANIONS – AN UNUSUAL SOUVENIR FROM GAMBIA

E-Posters

E-POSTER VIEWING

Lena Birzele¹, Claudia Crowell¹, Pia Kuhlmann¹, Martin Alberer², Ulrich Von Both¹

¹Dr. von Hauner Children's Hospital, Division Of Pediatric Infectious Diseases, München, Germany, ²German Centre for Infection Research (DZIF), Infection Research, Munich, Germany

Title of Case: UNEXPECTED TRAVEL COMPANIONS – AN UNUSUAL SOUVENIR FROM GAMBIA

Background: Myiasis is a rare diagnosis in Germany and is usually only seen after travel to endemic areas. Here we describe a case of myiasis with an initially unclear route of transmission.

Case Presentation Summary: A previously healthy 14 months-old boy presented to our A&E with five abscess-like skin lesions (image 1). Per parental report, the largest lesion was lanced at home with subsequent removal of five larvae. Suspecting myiasis, he was admitted for treatment of the remaining lesions by covering them with an occlusive transparent film to deprive the larvae of oxygen and encourage them to emerge. However, no additional larvae were retrieved from any of the covered lesions. Interestingly, the patient's last reported international travel was 7 months prior to presentation, which is well beyond the typical 6-10 week period between infestation and development of skin manifestations. On further detailed conversation, the patient's father disclosed that he had travelled to The Gambia a few weeks prior and returned with clothes for his boy as a present. These clothes likely acted as the "travel-vehicle" for the botfly eggs. Upon repeated history taking, trying to overcome the language barrier, the father eventually reported to have lanced all five lesions at home removing one solitary larva from each. The patient was discharged and made a full recovery documented in a follow-up visit 10 days later.



Learning Points/Discussion: Myiasis in Germany is rare and primarily seen in returning travelers. Infestation without travel to endemic areas can occur indirectly when botfly eggs are transported on clothing to non-endemic areas. Ensuring adequate washing or ironing of clothes imported from endemic areas is key to preventing such transmission events.

EP125 / #1563

Topic: AS05. Global health / AS05.b. Tropical/parasite infections & travel medicine

EXOTIC ANIMALS, THE RISK FOR STRONGYLOIDIASIS EPIDEMIOLOGY

E-Posters

E-POSTER VIEWING

Joana Ferreira Mendes¹, Francisca Guimarães Strecht¹, Hermínia Costa², Cláudia Almeida¹
¹Centro Hospitalar de Entre Douro e Vouga, Pediatric Department, Santa Maria da Feira, Portugal, ²Centro Hospitalar de Entre Douro e Vouga, Microbiology, Santa Maria da Feira, Portugal

Title of Case: Exotic animals, the risk for strongyloidiasis epidemiology

Background: Strongyloidiasis, caused by *Strongyloides stercoralis* (Ss), is a helminth infection, more prevalent in tropical areas and poor socioeconomic and sanitary conditions. The Ss lives in soil and can infect reptiles, pets, and humans through the penetration of larvae into the skin, invading the bloodstream and reaching the intestine. Most cases registered in Europe are imported, although autochthonous infections in adults are described. Usually, Ss infection is asymptomatic, occasionally presenting with eosinophilia or mild gastrointestinal symptoms, with risk for progression to chronic, potentially serious, and fatal infection in immunocompromised hosts.

Case Presentation Summary: A 4-year-old boy, with chronic diarrhoea (without blood or mucus) and flatulence. On examination, only erythema in the perianal region was found. The symptoms remained after lactose eviction. From the background, the eviction of cow's milk proteins from 3 to 11 months due to suspected non-IgE mediated intolerance, was not confirmed. No recent travel history and currently has a Bearded Dragon (*Pogona vitticeps*) as a pet. The workup showed no anaemia, eosinophils $410 \times 10^6/L$, sedimentation rate 17mm. Parasitological faecal study revealed the presence of Ss larvae and eggs. Medicated with albendazole 400mg 2id for 7 days, with later confirmation of elimination.

Learning Points/Discussion: With globalization and migratory movements, imported cases can occur in non-endemic areas. In addition, the trend towards the increasing diversity of species that we introduce into the family as pets, often not knowing the country of origin and possible complications to human health, increases the risk of transferring diseases to the human species. A detailed clinical history is essential in the investigation, and, despite Ss being associated with mild and benign disease, it is important to consider the possibility of chronic infection, with more serious consequences in cases of immunosuppression.

Topic: AS05. Global health / AS05.b. Tropical/parasite infections & travel medicine

INAPPROPRIATE USE OF ANTIBIOTICS AMONG CHILDREN IN THE COMMUNITY OF THREE LOW- AND MIDDLE-INCOME COUNTRIES

E-Posters

E-POSTER VIEWING

Antoine Ardillon^{1,2}, Lison Ramblière^{1,2}, Agathe De Lauzanne³, Perlinot Herindrainy⁴, Zo Andrianirina Zafitsara⁵, Jean-Baptiste Diouf⁶, Touch Sok⁷, Myriam Landau⁴, Laurence Borand³, Fatoumata Sarr⁸, Muriel Vray^{2,9}, Jean-Marc Collard¹⁰, Elisabeth Delarocque-Astagneau¹, Didier Guillemot^{1,2}, Elsa Kermorvant-Duchemin¹¹, Bich-Tram Huynh^{1,2}

¹INSERM-UVSQ-Univ Paris-Saclay, Cesp, Montigny-Le-Bretonneux, France, ²Institut Pasteur, Global Health, Paris, France, ³Institut Pasteur du Cambodge, Epidemiology Unit, Phnom Penh, Cambodia, ⁴Institut Pasteur de Madagascar, Epidemiology Unit, Antananarivo, Madagascar, ⁵Centre Hospitalier de Soavinandriana, Pédiatric Ward, Antananarivo, Madagascar, ⁶Centre Hospitalier Roi Baudouin, Pédiatrie, Dakar, Senegal, ⁷Ministry of Health, Cdc, Phnom Penh, Cambodia, ⁸Institut Pasteur de Dakar, Epidemiology Unit, Dakar, Senegal, ⁹Institut Pasteur de Dakar, Epidemiology Unit, Dakar, France, ¹⁰Institut Pasteur de Madagascar, Unité De Bactériologie Expérimentale, Antananarivo, Madagascar, ¹¹Assistance Publique–Hôpitaux de Paris, Université Paris Descartes, Hôpital Universitaire Necker-enfants Malades, Paris, France

Backgrounds: Inappropriate use of antibiotics is a major contributor to antibiotic resistance. However, such data are lacking at the community level in low- and middle-income countries, where the majority of the population is treated outside the hospital. We aimed to characterize the pattern of inappropriate antibiotics use among outpatient children and to identify associated determinants in Madagascar, Senegal and Cambodia.

Methods: We used data from a child cohort (BIRDY cohort, 2012-2018) conducted both in urban and rural areas of these 3 countries. Children were followed-up from birth up to the age of 24 months to document all their infectious episodes. All symptoms, diagnosis and antibiotics received were documented. We defined inappropriate use as unnecessary use of antibiotics based on the diagnosis of probable bacterial infection. We performed mixed logistic models to identify determinants associated with inappropriate use of antibiotic.

Results: Among the 3710 children included, there was 29% (3,448/11,762) consultations with antibiotic prescription. Amoxicillin accounted for 36% of all prescriptions. We found that 57.0%, 15.5% and 57.2% of prescriptions were inappropriate in Cambodia, Madagascar and Senegal, respectively. Bronchiolitis was the most common indication followed by gastroenteritis and rhinopharyngitis with 43.9%, 35.5% and 20% of inappropriate prescription, respectively. Being older than 3 months (aOR ranging from 1.93 [1.65-2.25] to 4.1 [3.1-5.5]) and a diagnosis with a higher severity score (2.1[1.7-2.4] to 3.6 [2.7-4.7]) were associated with an increased risk of inappropriate prescription in the 3 countries. Also, children from urban site were less at risk of receiving an inappropriate prescription (0.2 [0.1-0.3] to 0.5[0.4-0.6]).

Conclusions/Learning Points: Our findings show a significant proportion of inappropriate use of antibiotics and underscore the importance of implementing local programs to optimize antibiotic prescriptions at the community level.

EP127 / #549

Topic: AS05. Global health / AS05.b. Tropical/parasite infections & travel medicine

CHRONIC SCHISTOSOMIASIS IN A PAEDIATRIC PATIENT FOLLOWING ALLOGENEIC HEMATOPOIETIC BONE MARROW TRANSPLANTATION: A CASE REPORT

E-Posters

E-POSTER VIEWING

Kescha Kazmi, Kuang-Yueh Chiang
Hospital For Sick Children, Pediatrics, Toronto, Canada

Title of Case: Chronic schistosomiasis in a pediatric patient following allogeneic hematopoietic bone marrow transplantation: A case report

Background: Schistosomiasis is a chronic parasitic disease affecting millions living in endemic areas. Due to increased global migration, this parasitic disease may be encountered in non-endemic areas. However, schistosomiasis is rarely documented in hematopoietic bone marrow transplant recipients. We describe a case of chronic schistosomiasis in a pediatric patient following allogeneic hematopoietic bone marrow transplantation.

Case Presentation Summary: A 12-year-old male 1-month post-matched sibling allogeneic bone marrow transplant for severe aplastic anemia presented to a Canadian pediatric tertiary care hospital with jaundice. Initial investigations showed a transaminitis and cholestasis. Infectious work up demonstrated a cytomegalovirus (CMV) viremia at 5900 copies/mL, which was treated with valganciclovir. Despite resolution of CMV viremia and discontinuation of valganciclovir, the patient still had evidence of cholestatic liver disease. Abdominal imaging showed moderate hepatomegaly and mild splenomegaly. Peripheral eosinophilia (max $2.52 \times 10^9/L$) developed 2-months post-transplant. The patient underwent an ultrasound-guided liver biopsy. Liver biopsy demonstrated prominent eosinophils, plasma cells, and occasional granulomas with no evidence of graft-versus-host-disease. Epidemiologic history revealed the patient resided in sub-Saharan Africa until he immigrated to Canada 4 years prior to presentation. Serology for *Schistosoma* spp. IgG EIA came back reactive with an optical density of 3.66 and stool for ova and parasites (O&P) demonstrated *Schistosoma mansoni* eggs. The patient was treated with Praziquantel. Transaminitis and cholestasis gradually improved after therapy.

Learning Points/Discussion: This case highlights the importance of increasing awareness amongst clinicians of possible parasitic infections including schistosomiasis in bone marrow transplant recipients. Early detection by pre-transplant urine and stool samples for O&P examination and serologic screening for schistosomiasis in patients from endemic regions can prevent morbidity and mortality post-transplant.

EP128 / #1932

Topic: AS05. Global health / AS05.b. Tropical/parasite infections & travel medicine

DIAGNOSTIC CHALLENGES OF IMPORTED INFECTIONS DURING A PANDEMIC

E-Posters

E-POSTER VIEWING

Núria López Segura, Julieta Camarasa De Masdevall, Anna Borja Lloret, Lucía Román Eyo, Enric Alonso Alegre, Alberto Vicente Quesada, Amaia Bilbao Garitagoitia
Hospital del Mar, Pediatrics Department, barcelona, Spain

Title of Case: DIAGNOSTIC CHALLENGES OF IMPORTED INFECTIONS DURING A PANDEMIC

Background: Non-specific manifestations of imported diseases may lead to misdiagnosis, particularly when the focus is put on SARS-CoV-2 infection. We report two cases to describe these challenges.

Case Presentation Summary: A 15-year-old boy was referred in June 2020, due to fever, headache, abdominal pain and vomiting for 2 days. Physical exam was normal. Investigations showed C-reactive protein 17.9 mg/dL, procalcitonin 89.5 ng/mL, IL-6 55 pg/mL, Hb 11.6 g/dL, leukocytes 4630 (450 lymphocytes), platelets 44.000, D-dimer 1330 mcg/L, LDH 310 UI/L, RT-PCR SARS-CoV-2 negative. Sepsis versus multisystem inflammatory syndrome in children associated with COVID-19 (MIS-C) was suspected. A thorough anamnesis revealed that he lived in Lahore, Pakistan until 3 months ago. Blood film confirmed Plasmodium vivax malaria. Blood culture negative. He was treated with chloroquine and primaquine with no complications. A 14-year-old boy was referred in June 2021, due to fever for 4 days, with no other symptoms. He lived in Kalra Punwan (Punjab, Pakistan), until 5 days before travel. He had a negative SARS-CoV-2 antigen test on the second day of fever. He had been seen twice at primary care and hospital, but no imported disease was considered. On the fourth day of fever, RT-PCR SARS-CoV-2 was positive and blood culture grew extremely-drug-resistant Salmonella typhi. Physical exam was normal. He was treated with oral azithromycin for 7 days, with no complications or relapse.

Learning Points/Discussion: In a patient with fever, travel history has to be included even when trips are limited due to pandemic restrictions. A delay in diagnosing an imported disease could affect the clinical course of a patient and have public health implications. Coinfection with SARS-CoV-2 is possible, and it does not mean a worse prognosis.

EP129 / #1555

Topic: AS05. Global health / AS05.b. Tropical/parasite infections & travel medicine

DIAGNOSIS AND TREATMENT OF NEUROCYSTICERCOSIS IN CHILDREN: REPORT OF TWO CASES

E-Posters

E-POSTER VIEWING

Giulia Lorenzetti¹, Daniela Longo², Lorenza Romani³, Costanza Tripiciano⁴, Anna Hermine Markowich⁵, Sara Chiurchiù³, Stefania Bernardi⁶, Laura Lancella⁷

¹Bambino Gesù Children's Hospital IRCCS, Pediatric Academic Department, University Of Rome Tor Vergata, Roma, Italy, ²Neuroradiology unit, Imaging Department, Rome, Italy, ³Bambino Gesù Children's Hospital, IRCCS, Immunological And Infectious Disease Unit, University Department Of Paediatrics, Roma, Italy, ⁴Ospedale Pediatrico Bambino Gesù, Pediatric Academic Department, University Of Rome Tor Vergata, Rome, Italy, Roma, Italy, ⁵Bambino Gesù Children's Hospital, Paediatric Department, Rome, Italy, ⁶Bambino Gesù Children's Hospital, IRCCS, Immunology An Infectious Diseases Unit, Rome, Italy, ⁷Bambino Gesù Children's Hospital, IRCCS, Immunology And Infectious Diseases Unit, Rome, Italy

Title of Case: DIAGNOSIS AND TREATMENT OF NEUROCYSTICERCOSIS IN CHILDREN: REPORT OF TWO CASES

Background: Neurocysticercosis is the most frequent and preventable cause of acquired epilepsy worldwide. It is caused by *Taenia solium* cysts in central nervous system. We report two cases of healthy Indian girls who were admitted in 2017 and in 2021 respectively for a first episode of non-febrile focal onset seizure.

Case Presentation Summary: On admission brain CT scan was performed: in the youngest patient (2-year-old) the exam showed two hypodense circular lesions in the right occipital and left parietal lobes with perilesional edema and a punctiform hyperdensity within; in the older one (9-year-old) brain CT scan revealed a focal hypodensity with considerable perilesional edema in the right parietal lobe. Brain MRI confirmed CT findings and showed, in both cases, ring-enhancing lesions. Neurocysticercosis was suspected in both children because of MRI findings and the epidemiologic exposure criteria, being India an endemic area. Bacterial and viral infections were excluded through PCR and cultures on blood, stool and cerebrospinal fluid (CSF). Serology and PCR for *Taenia solium* on blood and CSF were performed. While results were pending, both patients started a treatment with albendazole, corticosteroids and antiepileptic drug. In the 2-year-old patient the research of *Taenia* resulted negative, 12 months follow-up MRI showed an important decrease in size of the lesions and the girl remained seizure-free for 24 months of further follow-up (Figure). The 9-year-old child had a positive serology for *Taenia solium* and one month follow-up MRI showed visible reduction of the abnormalities (Figure).

Patient #1

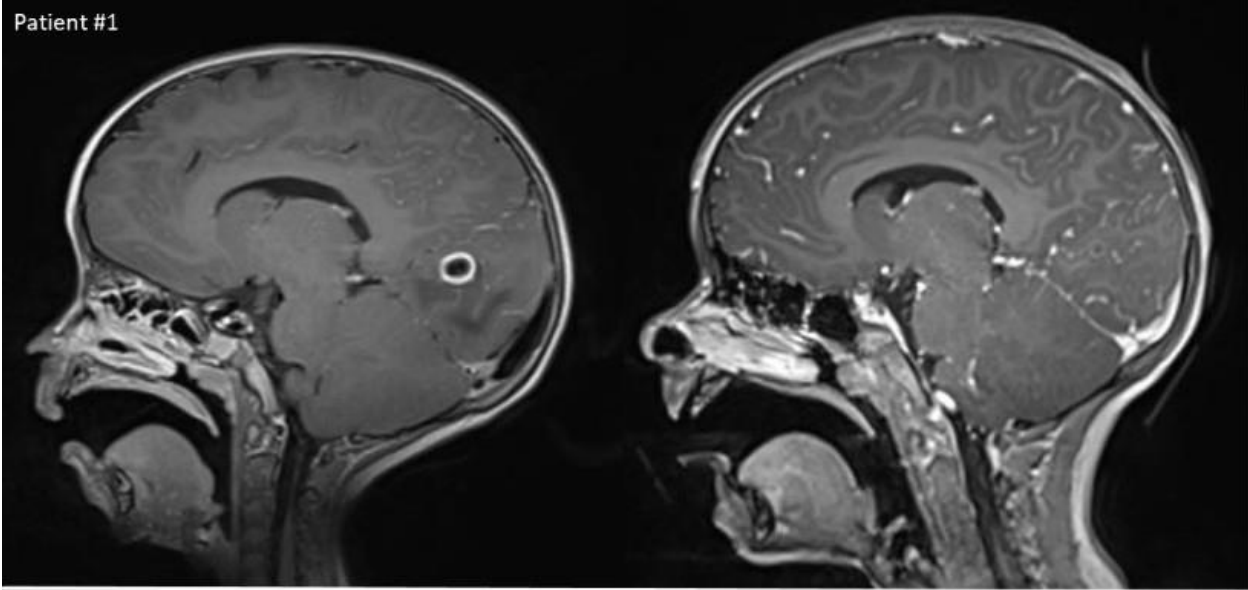

Patient #2

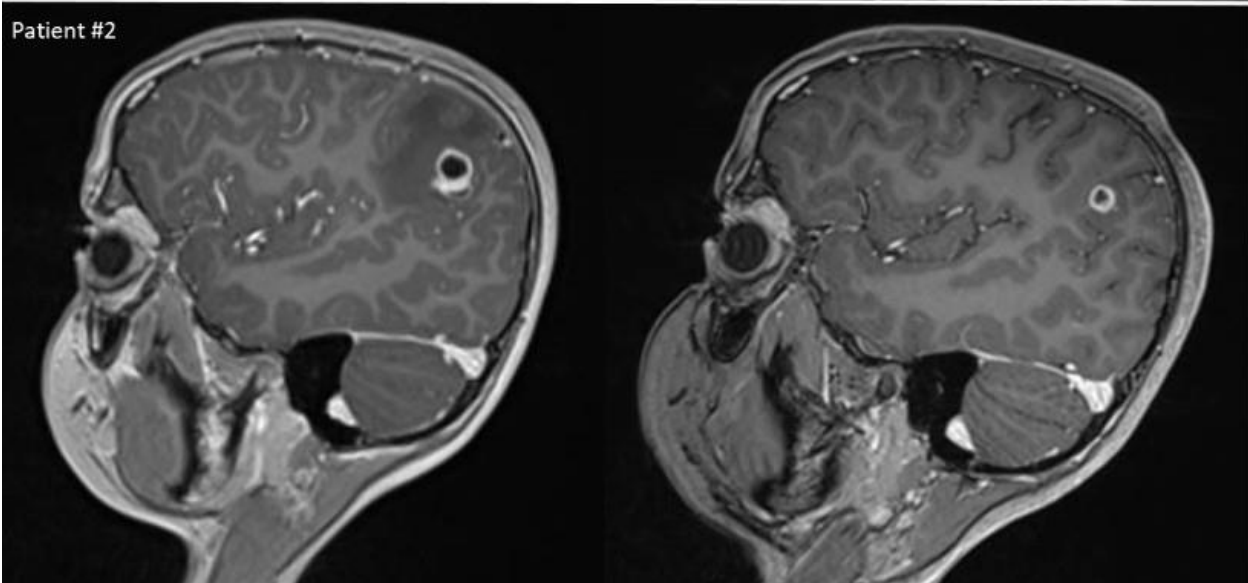

Learning Points/Discussion: Neurocysticercosis should be suspected whenever radiological findings and clinical manifestations are suggestive, even in non-endemic countries. Treatment should be started regardless of serology, as its negativity does not rule out the diagnosis.

Topic: AS05. Global health / AS05.b. Tropical/parasite infections & travel medicine

TRAVEL ASSOCIATED EXTENSIVELY DRUG RESISTANT TYPHOID FEVER: A CASE SERIES TO INFORM MANAGEMENT IN NON-ENDEMIC REGIONS

E-Posters

E-POSTER VIEWING

Harry Posen¹, Waison Wong², Daniel Farrar³, Aaron Campigotto⁴, Tiffany Chan⁵, Kevin Barker⁶, Stefan Hagmann⁷, Edward Ryan⁸, Regina Larocque⁸, Ashlee Earl⁹, Colin Worby¹⁰, Francesco Castelli¹¹, Victoria Fumadó Pérez¹², Philip Britton¹³, Michael Libman¹⁴, Davidson Hamer¹⁵, Shaun Morris¹⁶

¹The Hospital for Sick Children, Infectious Diseases, Toronto, Canada, ²Alder Hey Children's NHS Foundation Trust, Paediatric Infectious Diseases And Immunology, Liverpool, United Kingdom, ³Hospital for Sick Children, Centre For Global Child Health, Toronto, Canada, ⁴The Hospital for Sick Children, Microbiology, Toronto, Canada, ⁵Trillium Health Partners, Division Of Infectious Diseases, Mississauga, Canada, ⁶Trillium Health Partners, Division Of Microbiology, Department Of Laboratory Medicine And Genetics, Mississauga, Canada, ⁷Steven and Alexandra Cohen Children's Medical Center/Northwell Health, Division Of Pediatric Infectious Diseases, New Hyde Park, United States of America, ⁸Harvard Medical School, Massachusetts General Hospital, Boston, United States of America, ⁹Broad Institute, Bacterial Genomics Group, Cambridge, United States of America, ¹⁰Broad Institute, Infectious Disease And Microbiome Program, Cambridge, United States of America, ¹¹University of Brescia, Department Of Infectious And Tropical Diseases, Brescia, Italy, ¹²Hospital Universitari Sant Joan de Déu, Infectious Diseases Department, Barcelona, Spain, ¹³The Children's Hospital at Westmead, Department Of Infectious Diseases And Microbiology, Westmead, Australia, ¹⁴McGill University, Medicine, Montreal, Canada, ¹⁵Boston University School of Public Health, Department Of Global Health, Boston, United States of America, ¹⁶The Hospital for Sick Children, Infectious Disease, Toronto, Canada

Backgrounds: Travelers to Pakistan are at risk of extensively drug resistant (XDR) typhoid fever, which must be treated with a carbapenem or a macrolide. The objectives of this paper are to present a multicontinental case series of XDR typhoid fever acquired in Pakistan, and link laboratory findings with clinical data to assist front-line clinicians with their antimicrobial decision-making.

Methods: Cases were extracted from the GeoSentinel database, the microbiologic laboratory records of 2 large hospitals in Toronto, Canada, and by invitation to TropNet member sites. All isolates included in this study were confirmed XDR *S. enterica* serovar Typhi (*S. Typhi*), with resistance to ampicillin, ceftriaxone, ciprofloxacin, and trimethoprim-sulfamethoxazole. Data extracted included demographics and travel details, symptoms, timeline of illness and medical management, antimicrobial susceptibilities, and, where available, whole genome sequencing (WGS) reports.

Results: Seventeen cases were identified in Canada (10), USA (2), Spain (2), Italy (1), Australia (1), and Norway (1). Patients under the age of 18 years represented 71% (12/17) of the cases, and all patients were VFR (visiting friends or relatives) travelers. Predominant symptoms were fever, abdominal pain, vomiting and diarrhea. Antimicrobial therapy was started on the day of medical presentation in 75% (12/16) of patients, and transition to a carbapenem or macrolide occurred a median of 2 days after blood culture was drawn. Antimicrobial susceptibilities were consistent with the XDR *S. Typhi* phenotype, and WGS on 3 isolates confirmed their belonging to the XDR variant of the H58 clade.

Conclusions/Learning Points: Cases of typhoid fever imported from Pakistan may be resistant to first-line antimicrobials. An awareness of epidemiologic risk factors and clinical manifestations may improve early targetting of appropriate antimicrobial treatment (carbapenem for those with severe disease; macrolide for those with milder disease).

Topic: AS05. Global health / AS05.c. Refugees and migrants

UNACCOMPANIED ASYLUM-SEEKING CHILDREN (UASC): HIGH YIELD ON INFECTION SCREENING INCLUDING SEXUALLY TRANSMITTED DISEASES (STI)

E-Posters

E-POSTER VIEWING

Alexandra Cardoso Pinto¹, Paula Seery², Caroline Foster²

¹Imperial College London, School Of Medicine, London, United Kingdom, ²Imperial College Healthcare NHS Trust, Paediatric Infectious Diseases, London, United Kingdom

Backgrounds: Access and uptake of healthcare, screening and vaccination during displacement varies widely across Europe, exacerbated by the pandemic. A “one-stop shop” infectious disease screening was instituted and evaluated below.

Methods: Retrospective audit of electronic patient records for UASC referred by social, primary or community services in West London and attending screening from 01/11/2019 to 19/10/2021.

Results: Of 119 UASC reviewed; 89.2% (106) male, median age 17 (IQR 16-17). Most frequent countries of origin; Sudan (26.1%), Eritrea (22.7%) and Afghanistan (16.8%). Face-to-face interpreter present for 59.7% and phone interpreter for 21.8%. Median duration of travel to UK (n=65) was 2 years (IQR 0.75-4). 44.5% (53/119) had positive screening results requiring recall or onward referral. <20% reported accessing healthcare transiting through Europe. 21.0% (25/119) positive for latent TB infection and 1.7% (2/119) active TB disease. 4.3% (5/117) had chronic active hepatitis B and 19.7% (23/117) past infection. 1.7% (2/119) had HIV, both migrated on suppressive antiretroviral therapy. 12.5% positive for strongyloides (14/112). Four had STIs – 3/117 (2.6%) syphilis and 1/113 chlamydia (0.9%) – none disclosed sexual activity (consensual/non-consensual) at screening. 29.4% (35/119) reported issues with sleep, 39.5% (47/119) with mood. 28.6% (34/119) reported prior physical and 4.2% (5/119) sexual abuse. All received empirical antihelminth cover (albendazole 400mg) and cholecalciferol 20000units once weekly for 12-weeks; median vitamin D 23.2nmol/L (IQR 18.0-32.3).

Conclusions/Learning Points: Thorough screening, following UK guidelines, identified high positivity rates with almost half of UASC requiring follow-up. A tenth had active BBV, TB or STIs with public health implications for onward transmission. Guidelines should include routine non-judgmental asymptomatic STI screening, as targeted screening failed to identify infections. Services need to urgently reduce barriers to care for vulnerable youth migrating through Europe.

EP132 / #453

Topic: AS05. Global health / AS05.c. Refugees and migrants

AN INTERESTING CASE OF SKIN ULCERATION AND COMPLICATED OSTEOMYELITIS IN A PEDIATRIC PATIENT WITH NEWLY DIAGNOSED SICKLE CELL DISEASE

E-Posters

E-POSTER VIEWING

Alessandra Ferrari¹, Eleonora Foletto^{1,2}, Elisa Frosio^{1,2}, Lorenza Bonetti¹, Elena Carboni¹, Mariano Simeone Cosentino¹, Nadia Garau¹, Martina Soliani¹, Andrea Scaramuzza¹, Elisa Bertoni³, Claudio Cavalli¹

¹ASST Cremona, Unit Of Pediatrics, Cremona, Italy, ²University of Brescia, School Of Pediatrics, Brescia, Italy, ³ASST Spedali Civili di Brescia, Unit Of Pediatric Onco-hematology, Brescia, Italy

Title of Case: AN INTERESTING CASE OF SKIN ULCERATION AND COMPLICATED OSTEOMYELITIS IN A PEDIATRIC PATIENT WITH NEWLY DIAGNOSED SICKLE CELL DISEASE

Background:



We describe the case of a 15-year-old migrant girl from Mali, admitted to our Pediatric Unit for right pre-tibial skin ulceration and severe lower limb pain; the clinical onset occurred while she was febrile in Africa about 6 weeks before.

Case Presentation Summary: At admission laboratory exams showed microcytic anemia, elevated CRP, ESR and cholestatic indexes; blood culture was negative and skin culture through punch biopsy was positive for MSSA and Group B Salmonella. Right lower limb X-ray, MRI and whole-body bone scintigraphy revealed a single focus of osteomyelitis, connected through a fistula to pre-tibial skin ulcers. The peripheral blood smear showed anisopoikilocytosis and sickle cells, confirming the suspected diagnosis of osteomyelitis and skin ulceration in a newly diagnosed case of sickle cell disease. Leishmaniasis, Syphilis, tuberculosis, atypical mycobacteriosis and infection sustained by HIV, HBV or HCV were excluded through serologies and molecular chain reaction. Intravenous cefotaxime and oxacilline were successfully administered for 3 weeks, followed by oral switch to flucloxacilline for further 21 days. Moreover, skin wound dressings with silver nitrate and oxygen peroxide were performed until complete ulcers reepitelization. 3 months later right lower limb MRI showed no recurrence of osteomyelitis; therefore, hydroxyurea was introduced by the Hematologists, to prevent vaso-occlusive crises. 6 months later our patient, on treatment with hydroxyurea, developed right lower limb pain, fever and purulent drainage (culture positive for MRSA) in the previous site of skin ulcers.

Learning Points/Discussion: A therapeutic intravenous treatment based on daptomycin was administered for 3 weeks, followed by oral cotrimoxazole and ciprofloxacin for further 4 weeks; complete restitutio confirmed during the ongoing follow-up was achieved.

EP133 / #780

Topic: AS05. Global health / AS05.c. Refugees and migrants

FOOT LUMP IN AN AFRICAN MIGRANT GIRL

E-Posters

E-POSTER VIEWING

Rosario Stilwell¹, João Figueiredo², Lucia Fernandes³, Susana Norte², Catarina Gouveia⁴
¹Hospital Dona Estefania - Central Lisbon University Hospital Center, Paediatrics, Lisbon, Portugal, ²Hospital Dona Estefania - Central Lisbon University Hospital Center, Paediatric Orthopedics Department, Lisbon, Portugal, ³Hospital Dona Estefania - Central Lisbon University Hospital Center, Paediatric Radiology Department, Lisbon, Portugal, ⁴Hospital Dona Estefania - Central Lisbon University Hospital Center, Paediatrics Infectious Diseases Unit, Lisbon, Portugal

Title of Case: FOOT LUMP IN AN AFRICAN MIGRANT GIRL

Background: In children, bone and joint tuberculosis (TB) forms a small proportion of the total cases of tuberculosis. Systemic signs are commonly absent in early forms of the disease. In non-endemic regions, TB diagnosis is frequently delayed.

Case Presentation Summary: A previously healthy, female child, aged three, reports a dorsal lateral soft lump of the left foot with ten months of evolution. She had no fever, previous trauma, and she was able to walk without restrictions. She has arrived two weeks before from Angola, where she lived since she was three months old. Immunizations updated and included BCG. The lesion was soft and non-tender to touch, without local inflammatory signs, sized 2x3cm. MRI showed a cuboid lytic liquid-filled lesion, fistulising to the subcutaneous anterolateral tarsus. Initial workup shown normal leucogram ($5,54 \times 10^9/L$, neutrophils $1,54 \times 10^9/L$ - 28%, lymphocytes $3,51 \times 10^9/L$ - 63%), sedimentation rate (6mm/h), reactive protein C (0.2mg/L), negative IGRA and excluded HIV. The tuberculin sensitivity test was positive (15mm induration at 48h), thorax radiography and CT and abdominal ultrasound showed no lesions. She was admitted for surgical drainage and biopsy, she completed 17 days of flucloxacillin. Blood and bone conventional cultures were sterile. Lesion histology was compatible with a necrotizing granulomatous inflammatory process, with no agent identified by Ziel-Nielsen, Grocott's or PAS staining. TAAN was negative. Lowenstein-Jensen culture is still pending incubating. Assuming bone TB, although other mycobacteria cannot be excluded, she was started on antibacilar treatment with isoniazid (H) rifampicin (R), pyrazinamide (Z) and ethambutol (E).

Learning Points/Discussion: A high index of suspicion of bone-TB should be kept in children with "cold abscesses" especially in high-risk populations, to improve treatment response and reduce associated morbidity.

EP134 / #424

Topic: AS05. Global health / AS05.c. Refugees and migrants

FEVER AND HEADACHE IN A 9-YEAR-OLD MIGRANT BOY FROM ETHIOPIA: TUBERCULOUS MENINGITIS AND TUBERCULOMA

E-Posters

E-POSTER VIEWING

Evelien Van Kempen

Haga Ziekenhuis, Paediatrics, The Hague, Netherlands

Title of Case: Tuberculous Meningitis in a 9-year old migrant boy from Ethiopia

Background: In the Netherlands, each year approximately 35 children <15 years are diagnosed with tuberculosis (TB), of which 45% is born abroad. Refugees are screened upon entry with a chest X-ray. 45% of the TB cases concerns nonetheless an extrapulmonary manifestation. Regarding central nervous system tuberculosis (CNS-TB), TB-meningitis is the most frequent, followed by tuberculomas. Of children with TB, 0.5-2% has CNS-TB. In the Netherlands in 2019, 14 patients were diagnosed with TB-meningitis, all >15 years.

Case Presentation Summary: A 9-year-old Ethiopian boy who had been living in the Netherlands since 3 months presented at the Emergency Department with fever since 10 days, headache, sore throat, coughing and weight loss. Amoxicillin had been prescribed by the GP, without effect. Prior to this episode, he had no medical history and was fully vaccinated including BCG-vaccination. Physical examination showed a mild dehydration with no further abnormalities. General blood results were normal. Chest X-ray was normal. Malaria diagnostics were negative. He was admitted at the ward. Next day his clinical condition worsened with altered consciousness E4M2V5 gradually reducing to an EMV of 9, stiff neck, bradypnea and bradycardia. CT and MRI showed a ring-enhancing lesion located in the corpus callosum suspect for tuberculoma and TB-meningitis. He was intubed and started on 4 tuberculostatic agents and dexamethason. With these interventions his condition improved. Weeks later liquorculture was positive for M. tuberculosis.

Learning Points/Discussion: In children from TB high-endemic areas one must keep TB in mind, pulmonary but also extrapulmonary. Chest X-ray can be normal and quantiferon is not always performed (yet). Although rare, CNS-TB in a patient from a high-TB incidence country must be considered when presenting with fever and/or subacute neurological symptoms.

EP135 / #796

Topic: AS05. Global health / AS05.c. Refugees and migrants

CYSTIC ECHINOCOCCOSIS IN SPAIN: A RE-EMERGING AND NEGLECTED DISEASE AMONG MIGRANT CHILDREN. A LITERATURE REVIEW.

E-Posters

E-POSTER VIEWING

Álvaro Vázquez-Pérez, Juan Luis Santos-Pérez

Hospital Universitario Materno-Infantil Virgen de las Nieves, Pediatrics, Granada, Spain

Title of Case: CYSTIC ECHINOCOCCOSIS: A RE-EMERGING AND NEGLECTED DISEASE AMONG MIGRANT CHILDREN. A LITERATURE REVIEW OF PEDIATRIC CASES IN SPAIN.

Background: Cystic echinococcosis (CE) is considered a Neglected Tropical Disease and is estimated to affect more than one million people worldwide. Children with CE are especially vulnerable, with a frequent involvement in challenging socioeconomic situations. The incidence of CE is increasing in Europe because of high immigration flows from endemic countries. Nevertheless, CE is not covered by current migrant screening protocols. The main objective of this study is to review pediatric cases of CE in Spain published in the literature.

Case Presentation Summary: Methods A review of the literature was carried out, including scientific articles on cases of CE in children and young adults (0 to 20 years) diagnosed in Spain (1995-2021). The search was carried out using MeSH terms in MEDLINE/PubMed, Embase, Cochrane databases and the annual reports of the National Epidemiological Surveillance Network. Results A total of 14 patients were included. The median age was 9 years (IQR 7 - 13). 57% were male. 71% were immigrants (60% of them from Morocco). The organ most frequently affected was the lung (64%). Two cases (14%) were recurrences. Serology was positive just at 50%. Most of the patients received a combination of surgery and antiparasitics (64%). The most widely used antiparasitic was Albendazole (64%), in combination with praziquantel in 4 cases (29%).

Learning Points/Discussion: Unlike in adults, CE more frequently involves the lung than the liver in children. A negative serology result does not rule out the diagnosis of hydatid cyst, especially pulmonary cyst. There is an urgent need to expand CE surveillance efforts in non-endemic areas. Migrants and refugees from hyperendemic regions should be routinely screened for CE.

EP136 / #1917

Topic: AS06. Infections in early life / AS06.a. Congenital and perinatal infections

CONGENITAL SYPHILIS, PAST GHOSTS REEMERGENCE

E-Posters

E-POSTER VIEWING

Marta Arola¹, Marta Nicolas-Lopez², Clara Carreras-Abad³, M Soledad Vicen⁴, Marta Avila-Tierzi⁵, Gemma Ginovart²

¹Hospital Universitari Germans Trias i Pujol, Paediatrics, Badalona, Spain, ²Hospital Universitari Germans Trias i Pujol, Neonatology, Badalona, Spain, ³Hospital Universitari Germans Trias i Pujol, Pediatric Infectious Diseases, Badalona, Spain, ⁴Hospital Universitari Germans Trias i Pujol, Gynaecology And Obstetrics, Badalona, Spain, ⁵Hospital Universitari Germans Trias i Pujol, Pathologic Anatomy, Badalona, Spain

Title of Case: Congenital syphilis, past ghosts reemergence

Background: Syphilis is a chronic bacterial infection caused by *Treponema Pallidum*, classified as acquired or congenital, entailing a significant impact on maternal and infant health worldwide with up to 50% of vertical transmission in non-treated, infected, pregnant women. Despite previously achieved progress in western countries, current trends show alarming increasing rates of primary and secondary syphilis in the past decade.

Case Presentation Summary: A 20-year-old, 30+3 weeks (w) pregnant was referred to the maternal emergency area due to premature rupture of membranes ten days after amniocentesis. Medical record: normal first and second-trimester ultrasounds, low risk for chromosomal conditions, negative first-trimester serologies including syphilis and human immunodeficiency virus (HIV). Previously admitted at 28+3w because of self-limited metrorrhagia, ultrasound showed fetal ascites, hepatosplenomegaly, and placentomegaly with no other structural findings; blood tests showed normal blood cell count, hepatorenal function, and low inflammation markers. Therefore, amniocentesis was performed including array, metabolic and microbiological tests (bacterial, herpes simplex, herpes zoster, cytomegalovirus, parvovirus, and toxoplasma) without findings. Partner with HIV infection receiving antiretroviral therapy. On admission, a new ultrasound showed no fetal activity and intrauterine fetal death was confirmed. Fetal necropsy revealed congenital syphilis. Further serologic maternal tests confirmed early latent syphilis infection.

Learning Points/Discussion: Hydrops fetalis is a fetal condition characterized by abnormal interstitial fluid presence. It may result from a wide range of disorders, divided into two big categories: immune and non-immune, being congenital syphilis part of the latter. Most of these conditions may severely affect the fetus; thus, early diagnosis and treatment, if available, is mandatory. Nowadays, sexually transmitted diseases rates are dramatically increasing and should be considered in the diagnosis of hydrops or other related conditions even with previously negative screening tests.

EP137 / #325

Topic: AS06. Infections in early life / AS06.a. Congenital and perinatal infections

KNOWLEDGE AND PERCEPTIONS OF PREGNANT IN WESTERN GREECE ON CONGENITAL CYTOMEGALOVIRUS INFECTION

E-Posters

E-POSTER VIEWING

Christina Baladima, Sofia Benou, Gabriel Dimitriou, Aggeliki Karatza, Despoina Gkentzi
Patras Medical School, University of Patras, Department Of Paediatrics, Patras, Greece

Backgrounds: Cytomegalovirus (CMV) infection is the most common congenital infection worldwide causing serious morbidity in newborns, infants and children. The aim of the present study was to assess the level of knowledge on congenital CMV infection among pregnant women.

Methods: A questionnaire was completed by 125 pregnant women who were followed up in two tertiary hospitals in Patras, Western Greece (University General Hospital of Patras and General Hospital of Patras "Agios Andreas").

Results: The participation rate in the survey was 38.5%. Only 28.8% stated that they were aware of the congenital CMV infection, while 85.6% (107/125) answered that they did not know how the cytomegalovirus was transmitted. The level of knowledge was higher in pregnant women with a postgraduate or doctoral degree, in those with higher annual family income as well as in the age group of 30-35 years old. Regarding the complications caused by CMV infection focusing on the two most common ones (sensorineural hearing loss and developmental issues), 27.2% and 20.8% stated that they are aware of these complications respectively. Among the participants, 67/125 (53.6%) did not know if they had been tested for CMV during pregnancy. Regarding the preventive measures, only 19.2% were aware of all the possible ways to reduce the virus transmission.

Conclusions/Learning Points: The percentage of pregnant women who are aware of the congenital CMV infection and its complications is low in this cohort. It is of paramount importance to make interventions to improve the level of knowledge among pregnant women. Due to the lack of an effective vaccine as yet, education of women regarding hygiene measures is currently the best strategy to prevent cCMV infection.

EP138 / #1310

Topic: AS06. Infections in early life / AS06.a. Congenital and perinatal infections

**SECONDARY CYTOMEGALOVIRUS INFECTIONS: HOW MUCH DO WE STILL NOT KNOW?
COMPARISON OF CHILDREN WITH SYMPTOMATIC CONGENITAL CMV BORN TO MOTHERS
WITH PRIMARY AND SECONDARY INFECTION**

E-Posters

E-POSTER VIEWING

Fabiola Scaramuzzino¹, Michela Di Pastena², Sara Chiurchiù³, Maia De Luca⁴, Lorenza Romani⁴, Daniela Longo⁵, Martina Di Giuseppe³, Andrzej Krzysztofciak⁶, Giulia Lucignani⁵, Paolo Rossi⁴, Donato Amodio⁷, Stefania Bernardi³, Francesca Ippolita Calò Carducci³

¹Bambino Gesù Children's Hospital, Dpuo, Roma, Italy, ²clinical psychological unit, Psychological Unit, Rome, Italy, ³Bambino Gesù Children's Hospital, IRCCS, Immunology An Infectious Diseases Unit, Rome, Italy, ⁴Bambino Gesù Children's Hospital, IRCCS, Immunological And Infectious Disease Unit, University Department Of Paediatrics, Roma, Italy, ⁵Neuroradiology unit, Imaging Department, Rome, Italy, ⁶Bambino Gesù Children's Hospital, IRCCS, Immunology And Infectious Diseases Unit, Rome, Italy, ⁷Bambino Gesù Children Hospital, Clinical Immunology And Vaccinology, Rome, Italy

Backgrounds: Congenital cytomegalovirus (cCMV) can follow primary (PI) or secondary maternal infection (SI). In the past, symptomatic cCMV was thought to occur almost exclusively after PI but recent studies indicates that SI contributes to a much greater proportion of symptomatic cCMV than was previously thought.

Methods: We performed a monocentric retrospective study of babies with cCMV evaluated in our center from August 2004 to February 2021. We compared data of children born to mothers with PI with those born to mothers with SI, both at birth and during long term follow up.

Results: In total, we identified 175 babies with cCMV: 118 born to mother with primary infection (67.4 %) 27 born to mother with secondary infection (15.4 %) 30, with unavailable data about maternal infection (17.1%) Among the 145 babies with known maternal infection, 53 infants were classified as having a symptomatic cCMV infection: 40 of the 118 (33.9%) babies born to mothers with PI and 13 of the 27 (48.1%) babies born to mothers with SI. We found that the rate of unilateral neurosensorial hearing loss (NSHL) was significantly more frequent at birth (46.2%) in patients born to mother with SI than in those born to mother with PI (17.5%). During follow up (median 46,1 months), we found a higher rate of many sequelae (tetraparesis, epilepsy, motor and speech delay, and unilateral NSHL) in the group of children born to mother with SI, with a statistical difference for tetraparesis and unilateral NSHL.

Conclusions/Learning Points: Our data confirm that a previous maternal immunity does not provides a protection against severe cCMV infection in the newborn; therefore, we believe that universal neonatal screening should be offered.

EP139 / #60

Topic: AS06. Infections in early life / AS06.a. Congenital and perinatal infections

CONGENITAL SYPHILIS, CO-INFECTION IN A PRETERM INFANT WITH EARLY-ONSET SEPSIS DUE TO ENTEROBACTER CLOACAE

E-Posters

E-POSTER VIEWING

Sakviseth Bin, Sethikar Im

Calmette Hospital, Neonatal Icu, Phnom Penh, Cambodia

Title of Case: Congenital Syphilis, Co-infection in a Preterm Infant with Early-Onset Sepsis due to Enterobacter Cloacae

Background: Syphilis is a tropical disease, caused by a spirochete *Treponema pallidum*, which can be transmitted transplacentally from untreated mothers to the fetus during any stages of pregnancy. Clinical manifestations of early congenital syphilis are variable and non-specific. The diagnosis is based on the serology status of the mother, newborn clinical symptoms, and comparative serology titer between mother and newborn.

Case Presentation Summary: A late preterm female infant, appropriate-for-gestational-age, was treated for severe Early-Onset Sepsis due to *Enterobacter Cloacae* since Day 2 of life. The co-infection with *Treponema pallidum* was suspected and confirmed at Day 4 with clinical signs and a fourfold increase of Rapid Plasma Reagin (RPR) compared to mother's serology. Combined with Meropenem and Amikacin, Benzyl-Penicillin was used for 10 days, thereby resulting in a significant clinical and laboratory improvement. The girl was discharged at Day 18 and brought for regular follow-ups for both growth milestone and syphilis serology. RPR decreased fourfold at the age of 1 month.

Learning Points/Discussion: Syphilis should not be overlooked. The vertical transmission is preventable by an on-time treatment of the infected mother, triggered by a proper antenatal screening at the right time. Congenital syphilis should be ruled out in any challenging neonatal sepsis. The diagnosis tools and treatments are easily accessible and inexpensive in our economical settings.

EP140 / #434

Topic: AS06. Infections in early life / AS06.a. Congenital and perinatal infections

VERTICAL TRANSMISSION INFECTIONS - ACHIEVEMENTS AND NEW CHALLENGES

E-Posters

E-POSTER VIEWING

Gabriela Botelho, Anaísa Afonso, Mónica Marçal, Madalena Tuna
Hospital de São Francisco Xavier, Unidade De Cuidados Intensivos Neonatais, Lisboa, Portugal

Backgrounds: Some infections can be vertically transmitted to the foetus. The main pathogens are referred to as TORCH agents (Toxoplasmosis, Other - syphilis, varicella-zoster, parvovirus B19; Rubella, Cytomegalovirus and Herpes infections) and they contribute to early and later childhood morbidity. Other agents such as Human Immunodeficiency Virus (HIV) and Hepatitis viruses are also important. Cytomegalovirus is the most common congenital infection. Pregnancy routine care aims to identify these infections timely, preventing neonatal infection. The purpose of our study was to describe the paediatric population followed in our centre, to identify risk factors and opportunities to improve healthcare.

Methods: Observational, retrospective, descriptive, cohort study. Analysis of patients followed in a paediatrics vertical transmission infectious diseases clinic between December 2020 to November 2021. Statistical analysis using SPSS®, p-value<0.05.

Results: 100 children born to mothers with an infection during pregnancy were identified. Of these, 92% of pregnancies underwent routine care. The maternal conditions were Hepatitis B (n=30), HIV (n=29), CMV (n=20), Syphilis (n=15), Toxoplasmosis (n=6), Herpes (n=3) and Hepatitis C (n=1). There were 4 cases of co-infection. Most received appropriate prophylaxis/treatment; 22% of newborns developed congenital infection (CMV, n=20; Syphilis, n=2), and 10% clinical signs of disease (CMV, n=9, Syphilis n=1). 13% were admitted to NICU (CMV, n=7; Syphilis, n=3; Herpes, n=2; HIV, n=1).

Conclusions/Learning Points: Congenital infection was prevented in 78% newborns, which highlights the importance of adequate pregnancy and peri-natal screening and treatment. 22% of newborns developed congenital disease, mostly from Cytomegalovirus, which is not included in routine pregnancy surveillance in our country. Our study reflects a local reality and highlights the importance of medium/long-term follow-up.

EP141 / #463

Topic: AS06. Infections in early life / AS06.a. Congenital and perinatal infections

CONGENITAL TOXOPLASMOSIS IN TWINS: CASE REPORT

E-Posters

E-POSTER VIEWING

Martin Brizuela¹, Andrea Molina², Karina De Risio², Eduardo Otero²

¹Hospital General de Agudos "Dalmacio Vélez Sarsfield", Pediatrics, Buenos Aires, Argentina, ²Hospital Isidoro Iriarte, Neonatology, Quilmes, Argentina

Title of Case: Congenital toxoplasmosis in twins: a case report

Background: Toxoplasmosis is an infection caused by the protozoan *Toxoplasma gondii*. Its incidence during pregnancy ranges from 0.5 to 10 cases / 1,000 susceptible pregnant women depending on the country or region. The frequency and severity of fetal involvement are associated with the time of acquisition of infection during pregnancy. It is rare in twin pregnancies. We present a case of congenital toxoplasmosis in twins.

Case Presentation Summary: A 20-year-old woman with a monoamniotic, monochorial twin pregnancy. At 33 weeks, acute toxoplasmosis was diagnosed (positive IgG, positive IgM and avidity test <20%) and treatment with spiramycin 1 gram every 8 hours was started orally until the end of pregnancy. Twin, female, 38 weeks gestational age (GA) were born by caesarean section. They had reactive IgM and IgG for toxoplasmosis associated with brain and ocular involvement. They were treated with pyrimethamine 1mg / kg every 24 hours, sulfadiazine 50mg / kg every 12 hours orally, folinic acid 10mg orally and methylprednisone 1mg / kg / day orally.

Learning Points/Discussion: Congenital toxoplasmosis is an infection with variable clinical expression. The diagnosis and treatment in twin pregnancies does not differ from singleton pregnancies. Prevention of primary infection during susceptible pregnancies is essential

EP142 / #1419

Topic: AS06. Infections in early life / AS06.a. Congenital and perinatal infections

CONGENITAL TOXOPLASMOSIS: PREVENTION IS THE KEY

E-Posters

E-POSTER VIEWING

Joana Capela, Mariana Reis, Inês Almeida, Ecaterina Scortenschi, Luísa Gaspar
Centro Hospitalar Universitário do Algarve, Serviço De Pediatria, Faro, Portugal

Title of Case: Congenital toxoplasmosis: prevention is the key

Background: Toxoplasmosis is a zoonosis caused by the ingestion of *Toxoplasma gondii*. Congenital toxoplasmosis (CT) results from the passage of the parasite to the placenta. Manifestations range from asymptomatic disease to chorioretinitis, hydrocephalus, meningoencephalitis or fetal death. Secondary prevention is made by measurement of IgG and IgM in first trimester and studying avidity if they are positive. Fetal diagnosis consists of amniocentesis, mouse inoculation and serial ultrasounds. When seroconversion is detected, spiramycin prophylaxis should be started. If there is fetal infection, treatment with pyrimethamine, sulfadiazine and folinic acid should be initiated. Diagnosis in the newborn depends on serology and immunoblot, DNA PCR detection in body fluids, mouse inoculation, transfontanellar ultrasound and funduscopy. The same treatment protocol applies to the newborn.

Case Presentation Summary: We report a case of a three-month-old infant, born at forty-one weeks and a day, from a supervised pregnancy. Toxoplasmosis seroconversion occurred at thirteen week gestation, with positive maternal IgG and IgM serologies and high avidity, with primary infection for more than four months, so spiramycin prophylaxis was started. Serology and avidity were repeated at week eighteen, and as levels were stable, spiramycin was stopped. Fetal ultrasounds were normal, but after birth he had high IgG for toxoplasmosis, positive PCR in blood, positive mouse inoculation and transfontanellar ultrasound with a thalamus-striatal calcification. He started treatment with pyrimethamine, sulfadiazine and folinic acid, alternating with spiramycin, due to neutropenia.

Learning Points/Discussion: This case underlines the importance of surveillance and screening programs for pregnant women, and how a multidisciplinary approach between pediatricians and gynecologists might be important to reduce the risk of vertical transmission. It also highlights the importance of early diagnosis and treatment, in order to reduce morbidity.

EP143 / #850

Topic: AS06. Infections in early life / AS06.a. Congenital and perinatal infections

CONGENITAL SYPHILIS WAS FORGOTTEN IN SPITE OF NEONATAL DESQUAMATIVE LESION AND HIDDEN BY OTHER TROPICAL INFECTIOUS DISEASES

E-Posters

E-POSTER VIEWING

Chariya Chap, Ang Kim

National paediatric hospital, Neonatology, Phnom Penh, Cambodia

Title of Case: Forgotten congenital syphilis and hidden by dengue infection

Background: Congenital syphilis is still the global burden. It is the fetal infection with *Treponema pallidum* and gives a health issue for a long time. We are reporting one case below.

Case Presentation Summary: An 8-week-old male infant was admitted in the neonatal ward for day-4 of dengue infection. He was full term baby, birth weight of 3000g, born through vaginal delivery without antenatal screening. On arrival, he had fever 38°C, palor, hepatomegaly, bloody stool and desquamative lesions on the both soles found since day-15 of life and treated with steroid cream but no improvement. Laboratory tests showed an anemia (Hb 5,5 g/dl), thrombocytopenia 110 G/L, leukocytosis 22 G/L, CRP 118 mg/L. Dengue serologies were negative, TPHA (*Treponema Pallidum* Hemagglutination Assay) positive and RPR (Rapid Plasma Reagin) increased to 1:32, PT and aPTT in normal range. The serologies of syphilis for his parents were positive. He was treated with parenteral PNG 50 000UI/kg/8h for 10 days and transfusion of CE 20 ml/kg. At day-10 of treatment, WBC (white blood cells) decreased to 18,1 G/l and CRP 30,13mg/l, platelets increased to 213 G/L and Hb 9,8 g/dl.

Learning Points/Discussion: Our case is the early congenital syphilis due to presentation of symptoms before 2 years of life. This case exists hepatomegaly, anemia, thrombocytopenia, desquamative lesions and diarrhea as symptoms described by J. M. Cooper and P. J. Sanchez, 2018. Our diagnosis is based on perinatal history, clinical examination and serologies of syphilis for infant and mother. The management plan relies on the AAP guideline for syphilis 2021. Finally, the congenital syphilis should not be forgotten after eliminating other infectious disease such dengue infection especially in newborn with skin lesion.

EP144 / #1554

Topic: AS06. Infections in early life / AS06.a. Congenital and perinatal infections

HEMOPHAGOCYTIC LYMPHOHISTIOCYTOSIS – WHAT A CAUSE?

E-Posters

E-POSTER VIEWING

Vanessa Costa¹, André Almeida², Filipa Martins³, Margarida Areia⁴, Alzira Sarmento⁵, Alexandre Fernandes⁶, Laura Marques⁶, Paula Cristina Fernandes⁵

¹Centro Hospitalar Universitário do Porto, Pediatrics, Porto, Portugal, ²Centro Hospitalar Trás-os-Montes e Alto Douro, Pediatrics And Neonatology, Vila Real, Portugal, ³Centro Hospitalar Tondela-Viseu, Pediatrics, Viseu, Portugal, ⁴Centro Hospitalar Vila Nova de Gaia-Espinho, Allergy And Immunology, Vila Nova de Gaia, Portugal, ⁵Centro Hospitalar Universitário do Porto, Pediatric Intensive Care Unit, Porto, Portugal, ⁶Centro Hospitalar Universitário do Porto, Infectious Diseases And Immunodeficiencies Unit Of Pediatrics Department, Porto, Portugal

Title of Case: HEMOPHAGOCYTIC LYMPHOHISTIOCYTOSIS – WHAT A CAUSE?

Background: Hemophagocytic lymphohistiocytosis (HLH) is a rare but serious condition characterized by systemic hyperinflammation which can be primary or secondary to many diseases. Congenital syphilis, although preventable, remains a health-care problem. The authors describe a case of HLH secondary to congenital syphilis.

Case Presentation Summary: A previously healthy 48-days-old girl presented at emergency department fever, vomiting and prostration. She was born at term, by spontaneous uncomplicated delivery. Maternal syphilis screening in 3rd trimester and at delivery were not done. On admission she had pallor and hepatosplenomegaly. Laboratory findings revealed severe anemia (Hb 4.8 g/dL) and thrombocytopenia (platelets $55 \times 10^3/\mu\text{L}$), elevated ferritin (1135,7 ng/mL) and serum soluble IL-2 receptor was very high (11.125 U/mL). She was admitted in pediatric intensive care unit due to respiratory and hemodynamic instability. Empiric antibiotics were started associated to dexamethasone. Genetic, immunological and metabolic studies didn't reveal any cause to HLH; bone marrow aspiration revealed activated lymphocytes; investigation for infectious causes revealed positive serum VDRL and TPHA test and positive CSF VDRL. Benzathine penicillin G was administered, and direct syphilis complications were ruled out. Progressive clinical and analytic improvement were noted. Both parents had positive VDRL tests and received adequate treatment.

Learning Points/Discussion: Congenital syphilis is still a reality and can be associated with life-threatening conditions. Prompt recognition and treatment are crucial to better prognosis. HLH has been rarely associated to congenital syphilis, only two cases reported in literature. This case also reinforces the importance of maternal serological screening during pregnancy, which may prevent severe diseases.

Topic: AS06. Infections in early life / AS06.a. Congenital and perinatal infections

PROTECTIVE EFFICACY OF HEPATITIS B IMMUNOGLOBULIN & HEPATITIS B VACCINATION IN INFANTS BORN TO HBSAG-POSITIVE MOTHERS

E-Posters
E-POSTER VIEWING

Ma. Samantha De La Paz, Randy Urtula
 Dr. Jose Fabella Memorial Hospital, Pediatrics, Manila, Philippines

Backgrounds: HBV infection is highly endemic in the Philippines. The WHO estimates that the prevalence of HBV is about 1 in 10 people. Moreover, a study in 2013 reported a HBsAg seroprevalence of 16.7%, translating to an estimated 7.3 million Filipino adults. Chronic hepatitis B infection has a significant public health impact in the Philippines because it is a common cause of end stage liver disease and is the leading cause of Hepatocellular carcinoma

Methods:: Through quota sampling, 50 infants born to HBsAg-positive mothers between January to December 2020 were enrolled in the study. All infants were ages 9-12 months, received Post-exposure prophylaxis within 12 hours of birth and completed Hepatitis B vaccine series. A participant’s record form was filled up by the primary investigator that gathered the information from routinely collected data during patient assessment. Blood samples collected from the participants were tested for HBsAg and anti-HBs level at an independent diagnostic center.

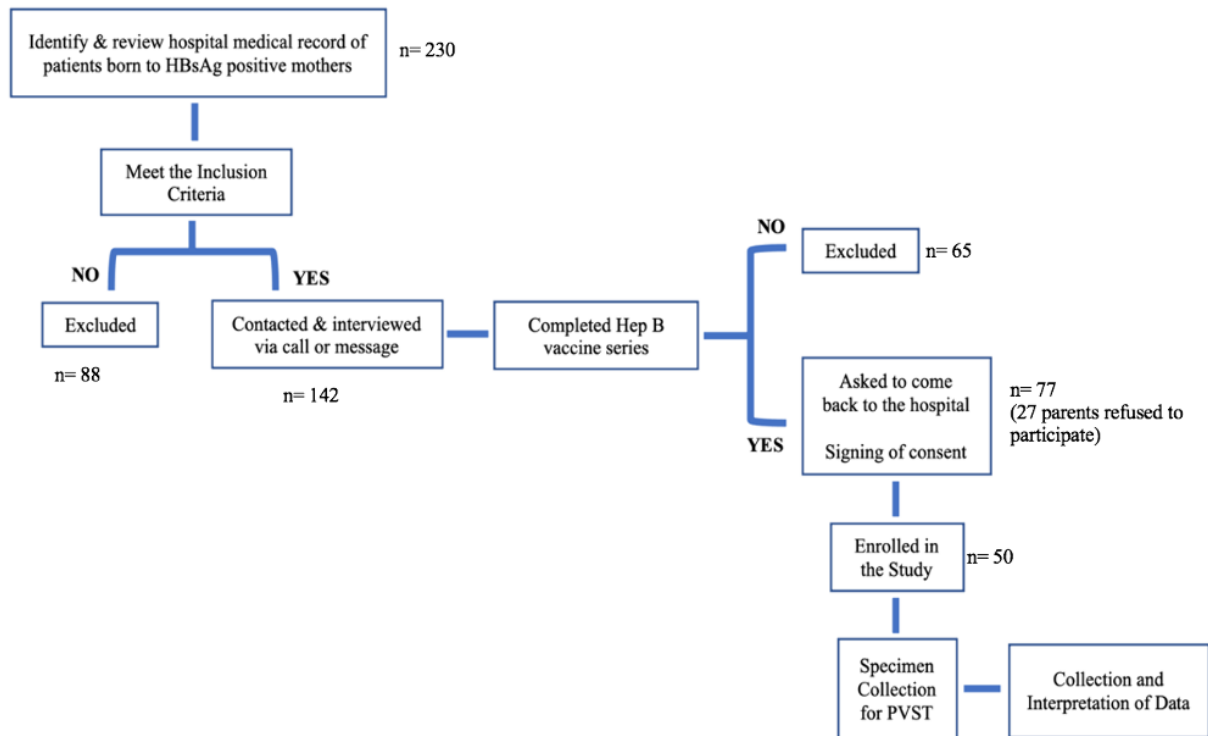

Results: Eight of fifty infants (16%) had levels of anti-HBs below cut-off value of 10 mIU/L. Based on HBsAg positivity and levels of anti-HBs at cut-off value of 10 mIU/mL, 84% of infants were vaccine responders with median level of anti-HBs at 132.33 mIU/L (IQR=259.88, range=0.12 to 796.4), 14% were non-responders (n=7) and 2% immunoprophylaxis failure and HBV infection

(n=1)

TABLE 4: Immunization outcome in infants born to HBsAg-positive mothers

| HBsAg and Anti-HBs | Proportion of Infants |
|---|-----------------------|
| HBsAg | |
| Positive | 1 (2%) |
| Negative | 49 (98%) |
| Anti-HBs level | |
| <10 mIU/mL | 8 (16%) |
| ≥10 mIU/mL | 42 (84%) |
| Outcome | |
| Vaccine responders | 42 (84%) |
| Vaccine non-responders | 7 (14%) |
| Immunoprophylaxis failure and HBV infection | 1 (2%) |

HBsAg: hepatitis B surface antigen, anti-HBs: antibody produced by the body against the surface antigens of the hepatitis B virus

Data are count (percent) on 50 infants born to HBsAg-positive mothers with post-exposure prophylaxis at birth.

Conclusions/Learning Points: In conclusion, Hepatitis B immunoglobulin and Hepatitis B vaccination of infants born to HBsAg-positive mothers were effective and allowed high protection against mother to child transmission. The HBIG and HB vaccination were a well-tolerated and safe regimen to prevent chronic HBV infection. PVST of infants born to HBsAg-positive mothers proved to be an essential strategy to ensure protection for vaccine non-responders and assure appropriate medical care for those infected.

EP146 / #1557

Topic: AS06. Infections in early life / AS06.a. Congenital and perinatal infections

GROUP B STREPTOCOCCAL INFECTION – A VERY LATE-ONSET CASE

E-Posters

E-POSTER VIEWING

Joana Ferreira Mendes¹, Inês Oliveira², Joana Soares Reis¹, Karina Oliveira¹, Benedita Aguiar¹
¹Centro Hospitalar de Entre Douro e Vouga, Pediatric Department, Santa Maria da Feira, Portugal, ²Centro Materno-Infantil do Norte, Centro Hospitalar Universitário do Porto, Paediatrics, Porto, Portugal

Title of Case: Group B streptococcal infection – a very late-onset case

Background: Group B Streptococcus (GBS) is an important cause of invasive disease in early age. Universal screening of pregnant women and intrapartum antibiotic prophylaxis reduced the incidence of early-onset disease but it has no impact on late-onset or very late sepsis. The pathogenesis of very late-onset sepsis is not well understood and etiologic agents and clinical approach change from the neonatal period.

Case Presentation Summary: A 95-day-old Caucasian full-term male infant was admitted to the emergency room with fever. Parents also reported irritability, intermittent grunting and poor feeding starting that day. The antenatal history was uneventful including negative serology and GBS screening. He was born from caesarean delivery by alterations in cardiotocography. There was a history of apparent viral respiratory infection one week before admission. At observation, he had normal vital signs but poor general status and grunting. Sepsis work-up showed cell count of 17600/uL, neutrophils 11700/uL and a C-reactive protein level of 4.6 mg/L. Urine and blood cultures were also drawn and parenteral ceftriaxone was started in meningeal doses. Lumbar puncture was delayed and performed 12h after admission showing 100 erythrocytes and 9 leukocytes in cerebro-spinal fluid (CSF) analysis. The infant was then hospitalized and completed 14 days of ceftriaxone for sepsis and suspected meningitis with clear improvement after the first day. The blood culture was positive after 8 hours and revealed a GBS sensitive to ceftriaxone. Bacteriological examination CSF was negative and transfontanelar ultrasonography was normal.

Learning Points/Discussion: Although GBS infection is more frequent in the early neonatal period, its pathogenicity is not insignificant during early infancy. It is however uncommon in infants born after 28 weeks gestation or without history of immunodeficiency. Horizontal transmission from colonized relatives or in the community, a decrease in specific GBS maternal antibodies or previous viral complications may play a role.

EP147 / #1123

Topic: AS06. Infections in early life / AS06.a. Congenital and perinatal infections

INVESTIGATION OF HEALTH SYSTEM BOTTLENECKS FOR DELIVERY OF PMTCT OF SYPHILIS SERVICES IN MALAWI.

E-Posters

E-POSTER VIEWING

Zacharia Kafuwa¹, Annelisa Majamanda², Monica Malata³, Enita Makwakwa³, Catherine Bamuya⁴, Amelia Crampin⁴, Gladys Gadama⁵, Lous Gadama⁶, Linda Mipando⁷, Eleanor Macpherson⁸, Harriet Chanza⁹, Christina Mchoma¹⁰, Effie Chipeta³, Bridget Freyne¹¹

¹Kamuzu University of Health Sciences, Public Health, Blantyre, Malawi, ²Blantyre District Health Office, Quality, Blantyre, Malawi, ³Kamuzu University of Health Sciences, Centre For Reproductive Health, Blantyre, Malawi, ⁴Malawi Epidemiology and Interventional Research Unit, Malawi Epidemiology And Interventional Research Unit, Blantyre, Malawi, ⁵KuHES, Department Of Obstetrics, Private Bag , Chichiri, Blantyre., Malawi, ⁶KuHES, Department Of Obstetrics, Private Bag , Chichiri, Blantyre., Malawi, ⁷KuHES, Department Of Public Health, Private Bag , Chichiri, Blantyre., Malawi, ⁸LSTM, Department Of Research, P.O Box , Chichiri, Blantyre., Malawi, ⁹World Health Organization, Maternal And Child Health, Blantyre, Malawi, ¹⁰Ministry of Health, Reproductive Health Directorate, Blantyre, Malawi, ¹¹CHI Crumlin, Paediatric Infectious Disease, Dublin, Ireland

Backgrounds: Maternal syphilis remains a public health concern globally due to the prevalence of associated adverse birth outcomes. Syphilis is the second leading infectious cause of stillbirth after malaria. The WHO has launched a campaign to eliminate mother to child transmission of syphilis by 2030. The aim of the study was to define health systems bottlenecks in the provision of syphilis PMTCT services in Malawi.

Methods: The study was a cross-sectional, mixed-methods study done at seven primary health facilities across the 3 regions of Malawi. Semi-structure interviews based on the WHO building blocks for quality of care were done with healthcare workers and district managers. Data was analysed by framework analysis using Nvivo v12. Cross-sectional survey data collected at (i) ANC and (ii) Delivery were visualised using a Tanahashi model of health systems bottlenecks. Rates of accessibility, availability and effective coverage were defined at both timepoints.

Results: Accessibility coverages in the Southern region was high at ANC (77.3%) and delivery (82.9%). There was marked geographic disparity with accessibility rates at ANC (42.1%) and delivery (35.3%) in the central and Northern regions. Effective coverage of same day test and treat services at ANC were 37.8% in Southern regions, whereas in Central and Northern regions where availability of testing was overcome, effective coverage of same day treatment was high at 84.2%. Qualitative data analysis identified health facility readiness, procurement processes and clinician training as barriers which contributed to the observed bottlenecks.

Conclusions/Learning Points: Visualising district specific bottlenecks allows for prioritisation of resource allocation and the implementation of locally effective policies to achieve PMTCT targets. Many bottlenecks could be overcome by introducing improvements within existing systems.

EP148 / #709

Topic: AS06. Infections in early life / AS06.a. Congenital and perinatal infections

THE MOST COMMON CLINICAL MANIFESTATIONS OF NEONATES WITH PULMONARY TRICHOMONIASIS: A GLOBAL SYSTEMATIC REVIEW

E-Posters

E-POSTER VIEWING

Mahdiyeh Taheri^{1,2,3}, [Reza Ghasemikhah](#)^{4,5}, Mehrdad Nahvi⁶

¹Shahid Beheshti University of medical sciences, Student Research Committee, School Of Nursing And Midwifery, Shahid Beheshti, Tehran, Iran, ²Shahid Beheshti University of Medical Sciences, Student Research Committee, School Of Nursing And Midwifery, Shahid Beheshti University Of Medical Sciences, Tehran, Iran, ³Shahid Beheshti University of Medical Sciences, Students Research Committee, Tehran, Iran, ⁴Arak university of medical sciences, Parasitology And Mycology, Arak, Iran, ⁵Arak University of Medical Sciences, Infectious Diseases Research Center (idrc), Arak, Iran, ⁶Arak university of medical sciences, Medical Diagnosis Laboratory Of Vali Asr Hospital., Arak, Iran

Backgrounds: Trichomoniasis is a common genital and sexually transmitted infection caused by *Trichomonas vaginalis*. The parasite can be transmitted from an infected mother to her baby during childbirth. One of the most common unusual organs in newborns is the lungs. The aim of this study is the most common clinical manifestations of neonates with pulmonary trichomoniasis.

Methods: In this systematic review study, all case report articles, published in English language all around the world, regarding the presence of *trichomonas vaginalis* in respiratory system among infants available in Scopus, PubMed, Science Direct, Google scholar, and Web of Science from 1980 to 2022 were searched and reported by two independent researchers. Titles and abstracts of all articles were reviewed for initial screening.

Results: First, all articles were reviewed and evaluated for quality, 5 full text articles reported seven cases of *Trichomonas vaginalis* in the respiratory tract of neonates. All reported cases were from 5 different cities (4 countries) in the world. The most common symptom in these neonates with trichomoniasis was respiratory distress.

Conclusions/Learning Points: Increasing awareness about the risk of neonatal trichomoniasis and its manifestations in infants with respiratory distress can be a factor in accelerating early diagnosis and treatment and preventing irreversible complications and death in these infants.

EP149 / #1106

Topic: AS06. Infections in early life / AS06.a. Congenital and perinatal infections

AN UNCOMMON CASE OF E.COLI O157 INFECTION IN A NEONATE PRESENTING WITH SEVERE DEHYDRATION AND BLOODY DIARRHEA

E-Posters

E-POSTER VIEWING

Ioannis Goniotakis, Eleftheria Hatzidaki

University General Hospital of Iraklion, Department Of Neonatology & Neonatal Intensive Care Unit, Iraklion, Greece

Title of Case: An uncommon case of E.coli O157 infection in a neonate presenting with severe dehydration and bloody diarrhea

Background: E. coli is the most common microbial species present in the intestinal flora of human and most animals. Certain pathogenic strains cause diarrhea in neonates and small infants. Enterohemorrhagic E.coli (EHEC) causes hemorrhagic colitis and in some cases, hemolytic uremic syndrome (HUS). E.coli O157:H7 is the most common and most virulent strain that is implicated in outbreaks.

Case Presentation Summary: We describe the case of a 21-day old neonate which presented with severe weight loss, non-bilious vomiting and bloody diarrhea since day 7 of life. Initially, the symptoms were relapsing and remitting, but the neonate's general condition gradually deteriorated. Upon admission, the neonate was severely dehydrated and presented with signs of hypovolemic shock. Laboratory investigations demonstrated leucocytosis, anemia, hyponatremia, metabolic acidosis and impaired renal function. Urinalysis showed significant proteinuria with a predominant low-molecular weight fraction. Intravenous fluids and empirical antibiotic treatment with ampicillin-gentamicin were given. Initial sepsis workup and investigations for metabolic disease came back negative. Radiological investigations ruled out surgical conditions. In the context of possible Food-Protein-Induced Enterocolitis Syndrome (FPIES) due to cow milk protein allergy, oral feeding was restarted using elemental formula. Despite initial improvement, bloody diarrhea relapsed. On repeat cultures, stool samples were negative for common pathogenic bacteria, but E.coli O157:H7 was isolated. The source of the infection could not be revealed and the neonate recovered uneventfully without developing HUS.

Learning Points/Discussion: Although EHEC infections are often described in infants and young children, neonatal infections are extremely rare. The maintenance of a high suspicion index in the suitable clinical context might enlighten the unknown epidemiology of EHEC infections in the neonatal population.

EP150 / #1588

Topic: AS06. Infections in early life / AS06.a. Congenital and perinatal infections

CLINICAL FEATURES OF COVID-19 IN NEWBORNS: EXPERIENCE IN CASES

E-Posters

E-POSTER VIEWING

Mykola Haras, Lorina Ivanova

Bukovinian State Medical University, Pediatrics And Pediatric Infectious Diseases, Chernivtsi, Ukraine

Title of Case: CLINICAL FEATURES OF COVID-19 IN NEWBORNS: EXPERIENCE IN CASES

Background: COVID-19 typically presents as an acute respiratory disease and pneumonia, although other systems may be affected. Transmission occurs mainly via respiratory droplets and aerosols, but other transmission routes such as perinatal transmission have been described. In the latter, it has been unclear whether it occurs via transplacental, transcervical or environmental exposure.

Case Presentation Summary: All newborns were full-term, 11 of them were born via natural way, in another case, and delivery was performed by caesarean section because of obstetric reasons. 9 children (75%) were breastfed. Causal epidemiologically significant contact was found in 11 children (91.7%), in particular, 3 newborns - contact with SARS-CoV-2 - a positive mother in childbirth. 9 children contacted with the source of infection at home after discharge from maternity hospitals and they implemented a manifest form of the disease with a predominance of general and respiratory symptoms. Thus, the most common symptoms were fever (7 children), runny nose (6 children) and refusal to eat (6 children). Gastrointestinal manifestations and symptoms of lower respiratory tract disease were less common, including cough (2 children), dyspnea (1 child), vomiting (2 children) and watery stool (1 child). Thrombocytosis (>500 G/l) was observed in laboratory tests in 3 newborns. In addition, 3 newborns who came into contact with SARS-CoV-2 - positive mothers in childbirth, realized asymptomatic subclinical forms of the disease.

Learning Points/Discussion: The implementation of manifest/asymptomatic forms of COVID-19 in the neonatal period depended on the time of contact of the newborn with the source of infection. Symptoms of manifest forms included signs of general malaise, respiratory and gastrointestinal manifestations.

EP151 / #1105

Topic: AS06. Infections in early life / AS06.a. Congenital and perinatal infections

WHY WE NEED UNIVERSAL SCREENING FOR DIAGNOSIS OF CONGENITAL CYTOMEGALOVIRUS INFECTION – AUDIT OF TIME TO DIAGNOSIS AND TREATMENT INITIATION

E-Posters

E-POSTER VIEWING

Styliani Alifieraki¹, [Chantal Hathaway](#)¹, Rachel Wei Ying Tan², Hermione Lyall¹

¹Imperial College Healthcare NHS Trust, Paediatric Infectious Diseases, London, United Kingdom, ²Imperial College London, Medical School, London, United Kingdom

Backgrounds: Cytomegalovirus (CMV) is the commonest cause of congenital infection with risk of adverse neurodevelopmental and hearing outcomes. Under-recognition results in restricted treatment options, negatively impacting the long-term prognosis. This study reviews the diagnosis and treatment initiation timing in infants referred to our Service, and reasons for delays.

Methods: Retrospective audit of infants with congenital CMV (cCMV) referred to our Tertiary Paediatric infectious disease centre. 155 internal and external referrals were received (4/2012-7/2021). Children with acquired CMV and those older than two years at time of diagnosis were excluded. 90 infants with confirmed cCMV were included.

Results: 46 (51%) infants were symptomatic at birth. cCMV testing of asymptomatic infants, was undertaken for failed newborn hearing screening (n=17), antenatal suspicion (n=14), low-birth weight (n=3) and postnatal hearing loss (n=2). Median time of first diagnostic test was day 3 and 7 for the symptomatic and asymptomatic groups. There was a significant risk of delay (>21 days) for the asymptomatic group [RR 2.93 (1.15-7.45); p-value 0.02]. The median age of referral was 10 and 22 days respectively. 78% of symptomatic infants received antiviral treatment compared to 54.5% of asymptomatic infants. Initiation of treatment was earlier for the symptomatic, compared to asymptomatic infants (median day 8 and 28 respectively). Delay in treatment initiation (>28 days) was significant amongst asymptomatic infants [RR 2.75 (1.18-6.43); p-value 0.02]. The commonest reason for this delay was delay in first diagnostic test for both symptomatic (67%) and asymptomatic infants (82%).

Conclusions/Learning Points: Delay in diagnosis and treatment of cCMV was significantly higher in the asymptomatic patients. This highlights the importance of increasing awareness amongst Antenatal, Neonatal, Paediatric and Audiology teams. Universal screening at birth would facilitate prompt diagnosis and management of infants born with cCMV.

EP152 / #1091

Topic: AS06. Infections in early life / AS06.a. Congenital and perinatal infections

A FATAL CASE OF NEONATAL TETANUS IN DR SOETOMO HOSPITAL SURABAYA, INDONESIA

E-Posters

E-POSTER VIEWING

Leny Kartina, Dwiyantri Puspitasari, Ismoedijanto Moedjito, Parwati Basuki, Dominicus Husada
Airlangga University / Dr Soetomo Hospital, Child Health, Surabaya, Indonesia

Title of Case: A FATAL CASE OF NEONATAL TETANUS IN DR SOETOMO HOSPITAL SURABAYA, INDONESIA

Background: Tetanus in neonate is a severe disease which is often fatal. It caused by *Clostridium tetani*, an aerobic spore-forming bacteria which produces exotoxin that responsible for symptoms. Poor feeding, rigidity, facial grimace, seizure triggered by stimuli until spontaneous general seizure are characteristic features that can be found. Neonatal tetanus is associated with non-sterile delivery and poor maternal immunization status for tetanus toxoid vaccine. Herein, we present a case of neonatal tetanus who was borned from unvaccinated mother.

Case Presentation Summary: A-seven-day old baby boy was referred to emergency room with main complaint of trismus, poor feeding, and seizure when he was touched for 2 days. He was delivered spontaneously at bathroom and the umbilical cord was cut with house scissor by witchdoctor. The baby also presented with 2 days of fever and purulent discharge of umbilical cord stamp. He was treated with diazepam intravenous continuously at dose 120 mg/24 hours, penicillin procaine, metronidazole, and anti-tetanus serum and oxygen mask supported. He was then intubated and assisted by ventilator machine because the spontaneous seizure still happened, but unfortunately, he passed away after 4 days admission because of refractory seizure and arrest.

Learning Points/Discussion: This case was typical features of neonatal tetanus. The delivery process in non-sterile condition, combined with lack of maternal antibody because of unvaccinated mother history, resulted umbilical cord infection. The shorter incubation period associated with the poorer prognosis. Maternal vaccination and skilled birth nursing are key to prevent neonatal tetanus.

EP153 / #1317

Topic: AS06. Infections in early life / AS06.a. Congenital and perinatal infections

PARTNER NOTIFICATION IN THE PREVENTION OF MOTHER TO CHILD TRANSMISSION OF SYPHILIS IN MALAWI

E-Posters

E-POSTER VIEWING

Kondwani Kaunda¹, Annelisa Majamanda², Monica Malata³, Enita Makwakwa⁴, Catherine Bamuya⁴, Amelia Crampin⁴, Gladys Gadama⁵, Lous Gadama⁵, Linda Mipando⁶, Eleanor Macpherson⁷, Effie Chipeta⁸, Bridget Freyne⁹

¹KuHES, Department Of Public Health, Private Bag , Chichiri, Blantyre., Malawi, ²Blantyre District Health Office, Department Of Quality Assurance, Blantyre, Malawi, ³KuHES, Centre For Reproductive Health, Blantyre., Malawi, ⁴Malawi Epidemiology and Interventional Research Unit, Department Of Research, Lilongwe, Malawi, ⁵KuHES, Department Of Obstetrics, Blantyre., Malawi, ⁶KuHES, Department Of Public Health, Blantyre., Malawi, ⁷LSTM, Department Of Research, Blantyre., Malawi, ⁸Kamuzu University of Health Sciences, Centre For Reproductive Health, Blantyre, Malawi, ⁹CHI Crumlin, Paediatric Infectious Disease, Dublin, Ireland

Backgrounds: Partner notification (PN) is an essential component of the WHO strategy for the elimination of mother to child transmission of syphilis. Adequate treatment of partners in the antenatal setting is essential to prevent congenital infection. The aim of this study was to determine the coverage of and barriers to partner notification and treatment in the antenatal setting in Malawi.

Methods: This was a mixed method study. The coverage of PN was determined from a cross sectional survey done at delivery. Demographic features and clinical outcomes associated with successful PN were assessed. Semi-structured interviews were undertaken with a purposive sample of pregnant women (n=12) with gestational syphilis and primary healthcare workers (n=11). Quantitative data was analyzed using STATA software version 14. Qualitative data was analyzed with Nvivo software version 12 and thematic content analysis was done.

Results: Out of 79 pregnant women with a diagnosis of gestational syphilis, 72 (91.1%) were informed of the need for partners treatment but only 38 (52.7%) partners received the recommended treatment. Successful treatment was more likely with advanced maternal age, higher SEG and higher maternal education level. Barriers to successful PN included fear of a negative reaction from partners, insufficient knowledge among pregnant women and resistance of partners to report to clinic. Community sensitization about the risk of syphilis in pregnancy was identified as a potential facilitator.

Conclusions/Learning Points: Successful partner treatment following a diagnosis of gestational syphilis is low in Malawi. Failed partner treatment undermines efforts to prevent mother to child transmission of syphilis. Educational campaigns, community sensitization and reorientation of clinics to provide male-sensitive services might improve rates of partner treatment in this setting.

EP154 / #741

Topic: AS06. Infections in early life / AS06.a. Congenital and perinatal infections

CONGENITAL SYPHILIS AS THE CAUSE OF MULTIPLE BONE FRACTURES IN A YOUNG INFANT

E-Posters

E-POSTER VIEWING

Maria Koliou, Elpida Chatzicharalampous, Myria Charalambous, Kyriakos Aristeidou
Archbishop Makarios Hospitalital, Paediatrics, Nicosia, Cyprus

Title of Case: CONGENITAL SYPHILIS AS THE CAUSE OF MULTIPLE BONE FRACTURES IN AN INFANT

Background: Treponema pallidum can cause congenital syphilis when transmitted from an infected pregnant woman to the fetus. Bone abnormalities can occur in 60-80% of cases of congenital syphilis and may be the sole manifestation. We describe a case of a young infant with multiple long bone fractures diagnosed with this rare disease.

Case Presentation Summary: This 2-month-old boy was referred to our hospital because of fractures of the ulna and distal radius bilaterally with the suspicion of osteogenesis imperfecta. After thorough examination, the infant had anemia and palpable spleen. A screen for congenital infections among other investigations was performed, which revealed positive non-treponemal and treponemal antibodies for syphilis. Hence the diagnosis for Congenital Syphilis was made. A lumbar puncture (LP) was performed which showed mild pleocytosis. The patient was treated with intravenous aqueous penicillin G 200 000 UI/KG per day for 10 days. In addition, a single dose of intramuscular penicillin G benzathine 50 000 UI/KG was given due to the abnormal CSF result. On follow up admission 6 months later, the new syphilis serology had much improved and the new LP revealed no abnormal findings.

Learning Points/Discussion: This case report is presented in order to remind of a common manifestation of a rare disease. Congenital syphilis, needs to be included in the differential diagnosis of multiple unexplained fractures in early infancy. In our case the fractures were symmetric and bilateral and they were accompanied by anemia and mild hepatosplenomegaly which led to the investigation of congenital syphilis as a possible cause. However, two thirds of infants with congenital syphilis are asymptomatic at birth. All women should have a proper syphilis screening during pregnancy.

EP155 / #911

Topic: AS06. Infections in early life / AS06.a. Congenital and perinatal infections

QUANTIFERON®-CMV ASSAY IN NEONATES WITH CONGENITAL CYTOMEGALOVIRUS INFECTION

E-Posters

E-POSTER VIEWING

Danai Ktena¹, Artemis Mavridi¹, Garyfallia Syridou¹, Fanouris Kontos², Nikolaos Siafakas², Vassiliki Papaevangelou¹

¹National and Kapodistrian University of Athens, Third Department Of Paediatrics, Attikon University Hospital, Athens, Greece, ²Attikon University Hospital, Microbiology Department, Athens, Greece

Backgrounds: The assessment of Cytomegalovirus (CMV)-specific T-cell responses has shown great promise in the evaluation of transplant patients at high risk of CMV infection. However, their value as a potential predictive factor for the long-term outcome of children with congenital CMV (cCMV) infection is yet to be determined.

Methods: In this prospective pilot study, we used the QuantiFERON®-CMV assay (Qiagen, Hilden, Germany) in blood samples drawn within the first month of life, in order to assess the anti-CMV cell-mediated immunity in neonates with cCMV infection. The association with symptomatic disease, neonatal CMV-DNA levels and the trimester of fetal infection was examined.

Results: QuantiFERON-CMV® assay was performed in blood samples from 8 neonates with cCMV infection. Four (50%) had symptomatic neonatal disease (clinical and/or laboratory and/or neuroimaging abnormalities) and all had a non-reactive QuantiFERON®-CMV result. In contrast, three of the asymptomatic neonates (75%) had a reactive QuantiFERON®-CMV result. However, likely due the small number of cases, no statistically significant association was detected between the QuantiFERON®-CMV results and the presence of symptomatic disease ($p=0.143$). Moreover, neither neonatal plasma CMV-DNA levels nor the suspected trimester of fetal infection were found to be correlated with QuantiFERON®-CMV results.

Conclusions/Learning Points: A non-reactive QuantiFERON®-CMV result appears to be more common in neonates with symptomatic cCMV infection. Further research is required to assess whether the QuantiFERON®-CMV assay could be used as an additional biomarker in infants with mild cCMV symptomatic disease, in which the benefit of treatment is still debatable.

EP156 / #885

Topic: AS06. Infections in early life / AS06.a. Congenital and perinatal infections

FETAL BRAIN IMAGING PROVIDES VALUABLE INFORMATION IN CCMV INFECTED INFANTS

E-Posters

E-POSTER VIEWING

Aikaterini Kyriakopoulou¹, Vassiliki Papaevangelou¹, Maria Argyropoulou², Matilda Papathanasiou³, Vasileios Xydis², Melpomeni Giorgi¹, Alexandra Ntorkou⁴, Efthymia Alexopoulou³
¹National and Kapodistrian University of Athens, Third Department Of Pediatrics, Attikon University Hospital, Athens, Greece, ²University Hospital of Ioannina, Department Of Radiology, Ioannina, Greece, ³School of Medicine, National and Kapodistrian University of Athens, 2nd Department Of Radiology, General University Hospital Attikon, Athens, Greece, ⁴Robert Debré University Hospital, AP-HP, Department Of Pediatric Radiology, Paris, France

Title of Case: Title: Fetal brain imaging provides valuable information in cCMV infected infants

Background: Congenital CMV is the commonest congenital infection with 10-15% of cases developing symptomatic disease. Early antiviral treatment is of essence when symptomatic disease is suspected. Recently, the use of perinatal imaging has been implicated as a prognostic tool of symptomatic disease. Even though neonatal MRI is commonly used when symptomatic disease is suspected, limitations have been implicated regarding the use of sedation on the neonatal brain. We are interested in assessing the use of fetal imaging as an alternative. Our primary aim was to compare fetal and neonatal MRIs of 10 children with congenital CMV infection

Case Presentation Summary: We performed a single-center retrospective cohort study (case-series) on a convenience sample of children born from January 2014 to March 2021 with congenital CMV infection who had undergone both fetal and neonatal MRIs. We created a checklist of relevant cerebral abnormalities and asked 4 blinded radiologists to assess the MRIs and then compared the findings of the fetal and neonatal imaging as well as the concordance in reporting of abnormalities within each category. Overall concordance between prenatal and postnatal scans was 70%. Two cases (20%) were discordant with abnormal fetal MRIs but normal neonatal MRIs. When comparing the two blinded reports for each MRI, we found high levels of concordance; 90% concordance for fetal MRIs and 100% for neonatal MRIs. The most common abnormalities identified in both scans were “White matter hypersensitivity” and “subependymal cysts”.

Learning Points/Discussion: Even though this is a small descriptive study, it indicates that fetal imaging could potentially provide us with valuable information when compared to neonatal imaging. This study could form the basis for subsequent larger studies in the future.

EP157 / #1336

Topic: AS06. Infections in early life / AS06.a. Congenital and perinatal infections

TO TREAT OR NOT TO TREAT: AN UNLIKELY DIAGNOSIS TO CONSIDER

E-Posters

E-POSTER VIEWING

Sofia Miranda¹, Cátia Silva¹, Inês Correia Magalhães¹, Sandra Catarina Ferraz¹, Ana Reis E Melo², Hugo Rodrigues¹

¹Unidade Local de Saúde do Alto Minho, Pediatrics, Viana do Castelo, Portugal, ²Centro Hospitalar Universitário de São João, Paediatrics Infectious Diseases And Immunodeficiencies, Porto, Portugal

Title of Case: To treat or not to treat: an unlikely diagnosis to consider

Background: Congenital Syphilis (CS) is caused by vertical transmission of *Treponema Pallidum* during pregnancy. In last years an increasing number of CS has been recorded. Prenatal screening for CS is an effective public health intervention to avoid mother-to-child transmission.

Case Presentation Summary: We present a case of a 3-month-old boy with a 5-day history of irritability and fever. There was a story of nasal discharge and poor weight gain. He was born by cesarean-section at 38 weeks and 4 days of gestation. Prenatal history revealed maternal syphilis diagnosis at third trimester, with VDRL 1/512 but a negative VDRL at the first and second trimester. The mother was treated with 2,4 million units of benzathine penicillin G 31 days before delivery. At birth, mother's VDRL was 1/32 and baby' VDRL 1/16. Birth' LCR exam was normal and VDRL LCR was negative. The child was discharged without treatment maintaining serologic follow-up. At 1 month-old, VDRL was 1/2. At admission, relevant findings were nasal discharge, macular rash and inguinal lymphadenopathy. Relevant laboratory exams demonstrated hemoglobin of 7,7 g/dl and C-reactive protein of 11.68 mg/dL. LCR examination was normal. Endovenous antibiotherapy was initiated with ampicillin and cefotaxime. During hospitalization, it was noted lack of movement of the right leg. Radiographs revealed metaphyseal destruction of the right proximal tibia. VDRL revealed a 1/128 title and positive TPHA. He was treated with aqueous crystalline penicillin G for 21 days.

Learning Points/Discussion: Our case shows syphilis transmission in a high-income country, even with adequate prenatal screening. CS occurred although adequate mother treatment 4 weeks before delivery, suggesting that treatment option with penicillin may be preferable in case of CS less likely.

EP158 / #1046

Topic: AS06. Infections in early life / AS06.a. Congenital and perinatal infections

CONGENITAL CYTOMEGALOVIRUS: REFLECTION ON MORBIDITY AND REVIEW OF STRATEGIES.

E-Posters

E-POSTER VIEWING

Catarina Granjo Morais¹, Carolina Faria², Ana Reis E Melo², Margarida Tavares²

¹Centro Hospitalar e Universitário São João, Department Of Pediatrics, Pedrouços - Maia, Portugal, ²Centro Hospitalar Universitário de São João, Paediatrics Infectious Diseases And Immunodeficiencies, Porto, Portugal

Backgrounds: Congenital cytomegalovirus (cCMV) is the main cause of nonhereditary sensorineural hearing loss (SNHL) worldwide and it is also responsible for long-term neurodevelopmental delays. Therefore, we aim to characterize the clinical and neuroimaging features of cCMV cases in our institution and to evaluate their association with long-term audiological and neurodevelopmental morbidity. A secondary aim was to compare our diagnostic/therapeutic strategies before and after the 2015 conference of the European Society of Paediatric Infectious Diseases (ESPID).

Methods: Maternal/infant records were retrospectively reviewed. All cases of confirmed cCMV born between January 2009 and December 2018 were included.

Results: Twenty-one patients were evaluated. Morbidity related to cCMV occurred in 18 (85.7%) patients; four (19%) had SNHL, with one case of late presentation. Abnormal prenatal neuroimaging, petechiae/purpura, hepatosplenomegaly, thrombocytopenia, and elevated liver enzymes were significantly associated with overall morbidity. Neonatal cholestasis and intracranial calcifications were also significantly associated with SNHL. The main changes in our approach after the 2015 ESPID conference were the specimens collected for CMV testing.

Conclusions/Learning Points: Consistent with current literature, abnormal prenatal neuroimaging appears to be an important prognostic factor, which may suggest that therapeutic prenatal approaches should continue to be explored. The predictive value of neonatal symptoms on morbidity should be assessed by multivariate analysis on a larger sample. Recommendations resulting from expert international meetings are essential to improve the quality of diagnostic approaches, to standardize symptomatic disease criteria and to increase awareness on healthcare providers.

EP159 / #1103

Topic: AS06. Infections in early life / AS06.a. Congenital and perinatal infections

RALTEGRAVIR: AN OPTION FOR CHILDREN WITH DYSLIPIDEMIA RELATED TO ANTIRETROVIRAL THERAPY.

E-Posters

E-POSTER VIEWING

Catarina Granjo Morais¹, Ana Reis E Melo², Carolina Faria², Margarida Tavares²

¹Centro Hospitalar e Universitário São João, Department Of Pediatrics, Pedrouços - Maia, Portugal, ²Centro Hospitalar Universitário de São João, Paediatrics Infectious Diseases And Immunodeficiencies, Porto, Portugal

Title of Case: Raltegravir: an option for children with dyslipidemia related to antiretroviral therapy.

Background: The purpose of Human immunodeficiency virus (HIV) treatment is to suppress viral replication for as long as possible, avoiding drug resistance and disease progression. Early antiretroviral initiation seems to limit the size of the HIV 'reservoir'. An individualized treatment should consider psychosocial problems, pharmacokinetics and side effects.

Case Presentation Summary: We report the case of a female with HIV-1 infection vertically transmitted. Pregnancy was only monitored after 29 weeks of gestation. Maternal HIV-1 infection (46000 copies/mL) was treated with tenofovir, atazanavir and ritonavir since 30 weeks of gestation (970 copies/mL at 36 weeks). She was born by vaginal delivery at 37 weeks and a four-week zidovudine prophylaxis regimen was performed. HIV-1 diagnosis was confirmed at six weeks (839000 copies/mL; N1 by CDC). No drug resistances were identified by genotypic testing and she was negative for allele HLA-B*5701. Abacavir, lamivudina and lopinavir/ritonavir were initiated. Even with high doses of protease inhibitors (PIs), viral loads were consistently > 50 copies/mL (despite excellent therapeutic compliance and apparently adequate drug absorption). She developed severe dyslipidemia as a side effect of PIs. Genotypic testing was repeated, without evidence of drug resistance. Treatment regimen was altered to lamivudina, nevirapina and lopinavir/ritonavir, achieving viral suppression during 16 months. However, due to persistent dyslipidemia, use of raltegravir was authorized. She was treated with lamivudina, abacavir and raltegravir and, at two years of follow-up, normalization of lipid profile was obtained. She maintains viral suppression at the age of four.

Learning Points/Discussion: In children treated with PIs, metabolic complications could compromise the benefits of adequate viral suppression. Integrase inhibitors (eg. raltegravir) appear to be a valid alternative due to a neutral effect on lipid profile.

EP160 / #1859

Topic: AS06. Infections in early life / AS06.a. Congenital and perinatal infections

FORGOTTEN BUT NOT GONE – SYPHILIS IN BABIES

E-Posters

E-POSTER VIEWING

Sehrish Gul Muhammad Aziz, Varsha Sadavarte

University Hospital of North Midlands, Paediatrics, Stoke on Trent, United Kingdom

Title of Case: FORGOTTEN BUT NOT GONE – SYPHILIS IN BABIES

Background: Congenital syphilis remains a significant public health problem worldwide despite the availability of preventive strategies for the identification of the risk for new-born. According to the World Health Organization (WHO) 2019 report, 1% or more of antenatal care attendees in 38 of 78 reporting countries tested positive for syphilis. Syphilis in pregnancy is the second leading cause of stillbirth globally and also results in prematurity, low birth weight, neonatal death, and infections in new-borns. We report two neonates with a diagnosis of congenital syphilis. These cases shed light on the importance of awareness, and early diagnosis.

Case Presentation Summary: The first baby was born premature at 34 weeks following an unbooked pregnancy. The mother had no antenatal care and no history of previous treatment for syphilis. TORCH screen was performed showing Treponema IgM positive and reactive RPR for which he was treated and responded well. A lumbar puncture showed no evidence of neurosyphilis. Repeat syphilis serology was done when the baby was 6 months old and RPR was negative and did not require further syphilis tests. The second child was born term. Mother tested positive in her early pregnancy and was treated with good response. Baby was tested soon after he was born and the results were positive for Treponemal antibodies. No neonatal issues. Advised for a repeat syphilis serology at 6 months.

Learning Points/Discussion: In conclusion, congenital syphilis is still a major public health problem. These cases highlights that syphilis may go undetected in pregnant women, also in developed countries. Appropriate prenatal care with syphilis serologic testing at the first prenatal visit of all pregnant women regardless of their risk factors should be mandatory.

EP161 / #795

Topic: AS06. Infections in early life / AS06.a. Congenital and perinatal infections

CONGENITAL HCV INFECTION IN A SECONDARY LEVEL NEONATAL UNIT: EXPERIENCE OF THE LAST 9 YEARS

E-Posters

E-POSTER VIEWING

Alessandro Porta, Marta Bellini, Francesca Lizzoli, Luciana Parola
Hospital of Magenta (Milan, Italy), ASST Ovest Milanese, Pediatric, Neonatal And Neonatal Pathology
Units, Magenta (Milan), Italy

Backgrounds: Even if the risk of mother to fetus transmission during pregnancy is low, HCV infection in pediatric age is almost always the consequence of a vertical transmission. The detection of HCV positive pregnant and the differentiation between RNA positive or negative women is very important to detect risk newborns and plan an adequate specific follow-up.

Methods: Data from all infants born from HCV positive mothers from 2013 to 2021 in the Neonatal Unit of the Hospital G. Fornaroli of Magenta were collected in a retrospective analysis.

Results: From 2013 to 2021, 33 infants were born in our Neonatal Unit from HCV positive mothers (15 from HCV RNA positive and 18 from HCV RNA negative pregnant). 6 children did not carry on the follow-up to our Pediatric Infectious Diseases Outpatient Service. Considering the 27 remaining (13 from HCV RNA positive mothers) the follow-up was characterized by two blood tests in the first year of life to detect HCV RNA in infants (at 2-3 months and 6-8 months of life) and then another blood test at around 18 months of life to detect anti-HCV antibodies (and demonstrate loss of maternal antibodies). Two of the 27 children followed in our center (7.4%) resulted positive to HCV RNA (confirmed in two consecutive closed analysis) and then referred to a specific pediatric center. All these two children were born from HCV RNA positive mothers.

Conclusions/Learning Points: Detection of HCV positive pregnant is very important to early recognize risk newborns and program an adequate follow-up. Infants are diagnosed as infected in presence of two HCV RNA positive tests starting from the second month of life, or when anti-HCV antibodies are positive after 18 months of life.

EP162 / #1354

Topic: AS06. Infections in early life / AS06.a. Congenital and perinatal infections

PERSISTENT NEUTROPENIA DUE TO CONGENITAL TOXOPLASMOSIS TREATMENT

E-Posters

E-POSTER VIEWING

Berta Pujol-Soler¹, Isabel Vives-Oñós², Marie Antoinette Frick³, M. Teresa Coll Sibina¹, Pilar Llobet-Agulló¹

¹Hospital General de Granollers, Pediatric Unit, Granollers, Spain, ²Hospital Quironsalud Barcelona, Pediatric Unit, Barcelona, Spain, ³Hospital Universitari Vall d'Hebron, Pediatric Infectious Diseases And Immunodeficiencies Unit, Barcelona, Spain

Title of Case: PERSISTENT NEUTROPENIA DUE TO CONGENITAL TOXOPLASMOSIS TREATMENT

Background: Congenital toxoplasmosis is the result of transplacental fetal infection by *Toxoplasma gondii* after primary maternal infection. The severity depends on the gestational age at transmission. Early treatment may improve ophthalmologic and neurological outcomes. Its possible side effects include bone marrow suppression, hence it is administered concomitantly with folic acid.

Case Presentation Summary: A healthy asymptomatic male newborn was referred because of congenital toxoplasmosis. The patient was the product of a vaginal term delivery with normal physical examination. At 27weeks the mother presented toxoplasmosis seroconversion, therefore spiramycin was started. At 28weeks, positive *T. gondii* PCR in amniotic fluid was found, so pyrimethamine, sulfadiazine and folic acid were prescribed. Ultrasounds were normal. He underwent full study with normal results: blood tests, fundus, auditory evaluation, brain and abdominal ultrasound, CSF study, blood and CSF PCR. He started pyrimethamine(1mg/kg/day), sulfadiazine(100mg/kg/day) and folic acid(15mg/day, 3 times a week). Neutropenia (570neutrophils/mm³) was detected 7 weeks after treatment initiation. Despite the treatment suspension it persisted for 4months and worsened to 90neutrophils/mm³. G-CSF was prescribed and treatment was changed to clindamycin, pyrimethamine and folic acid, however, neutropenia remained. Autoimmune neutropenia was ruled out and he was subjected to bone marrow aspiration with diagnosis of peripheral neutropenia. The standard treatment was reinitiated with gradual neutrophils ascension around 1000/mm³. No infection was associated with these neutropenic values.

Learning Points/Discussion: In case of neutropenia, it is necessary to rule out other etiologies and modify the treatment according to the results. If it is compatible with peripheral neutropenia and the patient does not present major infections, it is preferable to continue with first-line treatment as it is the only one that has shown some effectiveness to reduce ophthalmological sequelae.

EP163 / #1858

Topic: AS06. Infections in early life / AS06.a. Congenital and perinatal infections

OCULAR LESIONS IN AN ADOLESCENT – A CHALLENGING DIAGNOSIS

E-Posters

E-POSTER VIEWING

Susana Ramos Oliveira¹, Renato Correia Barbosa², João Salgado Costa³, Maria Sousa Dias⁴, Carla Teixeira², Sofia Jordão¹

¹Pedro Hispano Hospital, Infectious Diseases Department, Matosinhos, Portugal, ²Pedro Hispano Hospital, Ophthalmology, Matosinhos, Portugal, ³Centro Hospitalar Universitário do Algarve, Internal Medicine, Faro, Portugal, ⁴Pedro Hispano Hospital, Pediatrics, Matosinhos, Portugal

Title of Case: Ocular lesions in an adolescent – a challenging diagnosis

Background: Pediatric uveitis is an uncommon entity, often associated with infectious diseases. Inflammation in a developing pediatric eye may lead to irreversible atrophic lesions, with major long-term functional impact. Congenital toxoplasmosis is one of the most frequent causes of pediatric chorioretinitis. While the first ocular lesions present at a median age of 3-years-old, they can manifest as late as 20 years after birth. Lyme's Disease rarely presents ocular manifestations. Self-limited conjunctivitis is the most reported symptom, but more severe manifestations of uveitis, choroiditis or retinal detachment have been described.

Case Presentation Summary: We present the case of a 13-year-old boy with two episodes of chorioretinitis, which occurred five years apart. At the age of 8 he presented with decreased visual acuity of the left eye. Fundus examination, through indirect ophthalmoscopy, objectified an active chorioretinal lesion, causing foveal and macular distortion and atrophy. Relevant past history included self-limited conjunctivitis. Laboratory workup revealed toxoplasmosis IgM negative/IgG positive and high titers of Borrelia IgM, confirmed by detection of OspC band in Western Blot. After 21 days of amoxicillin, ocular lesions improved. At the age of 13 he returned with decreased visual acuity of the right eye. Vitreous opacifications and punctiform chorioretinitis were objectified, suggesting active toxoplasmosis. Mother's serology was revisited: IgM/IgG negative during the third trimester of pregnancy and immune less than a year after delivery, compatible with vertical transmission. Treatment with prednisolone, pyrimethamine, sulfadiazine and leucovorin was initiated, with clinical improvement. After 2 months, he initiated suppressive therapy with co-trimoxazole.

Learning Points/Discussion: Congenital toxoplasmosis may present at a later age and physicians should have a high level of suspicion. Adequate and timely treatment is paramount to minimize the risk of lifelong sight-threatening lesions.

EP164 / #1219

Topic: AS06. *Infections in early life / AS06.a. Congenital and perinatal infections*

HERPANGINA IN A NEWBORN – WHAT IMPLICATIONS?

E-Posters

E-POSTER VIEWING

Beatriz Sá, Mariana Lopes, Elsa Guimarães, João Agro
Centro Hospitalar de Leiria, Paediatrics, Leiria, Portugal

Title of Case: HERPANGINA IN A NEWBORN – WHAT IMPLICATIONS?

Background: Herpangina is a common viral disease characterized by typical vesicular or aphthous lesions on an erythematous base in the palate, tonsils, uvula and pharynx. In neonates with perinatal exposure, clinical presentation of enterovirus infection may range from asymptomatic to severe disease with systemic involvement, including sepsis, meningoencephalitis, hepatitis, and myocarditis.

Case Presentation Summary: We report a case of a previously healthy female with 8 days of age with fever and oropharyngeal aphthous lesions on an erythematous base. Her mother and older sibling also had superior respiratory symptoms and sore throat. Blood analysis revealed monocytosis, with no other changes in blood count, and negative C reactive protein and procalcitonin. Blood and urine cultures, group B Streptococcus antigen in urine and SARS-CoV-2 polymerase chain reaction (PCR) test were negative. Swabs from the neonate's ulcers and from the mother's oropharynx were taken for enterovirus PCR, which was negative. She was discharged after 3 days, afebrile for 48 hours and having always remained haemodynamically stable and with no feeding difficulties.



Learning Points/Discussion: Neonatal herpangina has a broad range of severity. In our case there was a self-limited benign disease but we emphasize the need for clinical vigilance in the first days of disease to exclude potentially serious complications. In spite of the absence of etiologic confirmation, herpangina is a clinical diagnosis, which reinforces the importance of a thorough physical exam when presented with a newborn with fever.

EP165 / #1570

Topic: AS06. Infections in early life / AS06.a. Congenital and perinatal infections

ROLE OF BASELINE CSF AND OPHTHALMOLOGICAL ASSESSMENT IN THE MANAGEMENT OF CCMV INFECTION

E-Posters

E-POSTER VIEWING

Alejandra Sandoval¹, Jean-Francois Chicone¹, Valerie Lamarre², Christian Renaud³, Isabelle Boucoiran⁴, Soren Gantt⁵, Fatima Kakkar⁵

¹Montreal University, Department Of Pediatrics, Division Of Infectious Diseases, Chu Sainte-justine, Montréal, Canada, ²Montreal University, 1. department Of Pediatrics, Division Of Infectious Diseases, Chu Sainte-justine, Montréal, Canada, ³Montreal University, Department Of Microbiology, Montréal, Canada, ⁴Montreal University, Department Of Obstetrics And Gynecology, Montréal, Canada, ⁵Montreal University, Department Of Pediatrics, Division Of Infectious Diseases And Centre De Recherche Du Chu Sainte-justine, Montréal, Canada

Backgrounds: The initial evaluation for confirmed cases of congenital CMV (cCMV) infection varies across centers with limited data to guide specific practices. Our objective was to determine the prevalence of abnormal findings on routine baseline ophthalmological and cerebrospinal fluid (CSF) assessment, among both symptomatic/asymptomatic infants with cCMV.

Methods: Retrospective review of all cases of cCMV followed at Centre Hospitaliere Universitaire Sainte-Justine from September 2008 to Dec 2021. Baseline eye exams (within 3 weeks of birth) were made by pediatric ophthalmologists, while CSF was obtained according to physician judgment. Categorization of symptoms followed European consensus guidelines.

Results: Of 86 infants followed, 63 were symptomatic. 79 had documented ophthalmological assessments; overall, 74/79 (94%) had not evidence of CMV disease at baseline, 5 had non-specific findings (coloboma=1, fibrotic changes=1, hemorrhages=2, vitreous cells=1), 2 they normalized. 56 infants had follow-up assessments, and 5 were abnormal (coloboma=1, fibrotic changes=1, hemorrhages=2, pigmented scars=1). None of the infants had chorioretinitis. 30 of 86 infants underwent lumbar puncture. In 22% (7/31) cases, CSF PCR CMV was positive (CSF+) (VL range: 137-3853 copies/mL). Among those CSF+, 71% (5/7) had abnormal neuroimaging vs. 43% (9/21) of those with negative CSF PCR (CSF-) ($p=0.38$), 86% (6/7) of CSF+ had neuropsychiatric disorders at 5 years follow-up vs. 57% (12/21) ($p=0.36$) of CSF-, 71% (5/7) of CSF+ had severe hearing loss vs. 52% CSF-(11/21) ($p=0.67$), and 57% (4/7) of CSF+ required cochlear implant vs. 9% (2/21) of CSF- ($p=0.02$).

Conclusions/Learning Points: While baseline ophthalmological was of low clinical yield for cCMV associated disease, there was a higher risk of adverse outcomes associated with a positive CSF PCR. Larger studies are needed to determine whether CSF PCR can be a prognostic indicator for cCMV infection.

Topic: AS06. Infections in early life / AS06.a. Congenital and perinatal infections

ASSOCIATION BETWEEN HUMAN CYTOMEGALOVIRUS (HCMV) SHEDDING AND HCMV-SPECIFIC CELLULAR-MEDIATED IMMUNITY (CMI) AS MEASURED BY A HCMV-ENZYME-LINKED IMMUNE ABSORBENT SPOT (CMV-ELISPOT) ASSAY, IN HCMV-SEROPOSITIVE PREGNANT WOMEN

E-Posters

E-POSTER VIEWING

Shari Sapuan¹, Ngeekeong Tan², David Carrington², Vanessa Greening¹, Christine Jones^{1,3,4}, Robin Parsons¹, Cassie Pope², Blair Strang⁵, Paul Heath¹

¹St George's, University of London, Paediatric Infectious Diseases Research Group, London, United Kingdom, ²St George's University Hospitals NHS Foundation Trust, Medical Microbiology, London, United Kingdom, ³University of Southampton, Faculty Of Medicine And Institute For Life Sciences, Southampton, United Kingdom, ⁴University Hospital Southampton NHS Foundation Trust, Nih Southamton Clinical Research Facility And Nih Southamton Biomedical Research Centre, Southampton, United Kingdom, ⁵St George's, University of London, Infection And Immunity Research Institute, London, United Kingdom

Backgrounds: HCMV-seropositive pregnant women may shed HMCV in bodily fluids over the course of pregnancy. CMV-specific CMI may be important in controlling viral replication, viral shedding and potentially, in the prevention of vertical transmission to the foetus. We aimed to assess the relationship between HCMV shedding during pregnancy and HCMV-specific CMI using a HCMV-ELISPOT assay.

Methods: Informed consent was sought from HCMV seropositive pregnant women receiving antenatal care at a tertiary hospital in London (UK) to collect saliva, urine and vaginal secretion samples to test for HCMV DNA via PCR at three time-points (12-16 gestation weeks, 17-26 gestation weeks, 27 gestation weeks until delivery) in pregnancy. Blood samples were also collected at the same time-points to test with a HCMV-ELISPOT assay; results were recorded as responsive or non-responsive, as a spot count, and as specific spot counts to IE-1 and pp65 antigens.

Results: From 67 HCMV-seropositive pregnant women, 99 samples of saliva, urine, vaginal secretions and blood were obtained. A quarter of the women (17/67) shed HMCV in one or more samples on at least one time-point. All women had a responsive HCMV-ELISPOT result on at least one time-point. There were no significant differences in the detection of HCMV shedding based on the HCMV-ELISPOT spot count to IE-1. However, the mean HCMV-ELISPOT spot count to pp65 was lower at all time-points in women with shedding as compared with those without shedding (Figure 1).

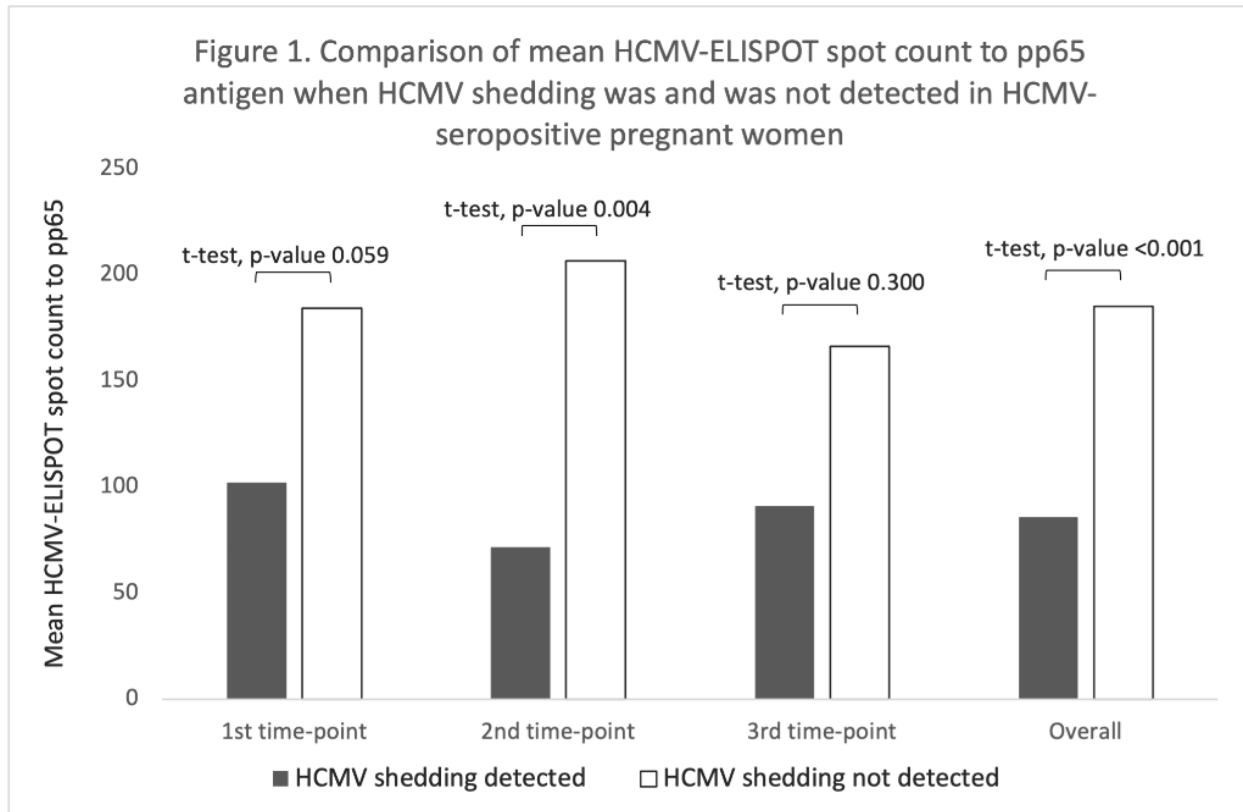

Conclusions/Learning Points: HCMV-specific CMI against pp65 antigen, as assessed with a HCMV-ELISPOT assay, may be important in the control of HCMV shedding in HCMV-seropositive pregnant women.

EP167 / #1528

Topic: AS06. Infections in early life / AS06.a. Congenital and perinatal infections

CLINICAL AND LABORATORY CHARACTERISTIC OF CONGENITAL PNEUMONIA IN FULL-TERM NEWBORNS AND PRETERM NEWBORNS

E-Posters

E-POSTER VIEWING

Olga Simachenko¹, Tatyana Artsemchik¹, Olga Gorbich²

¹Belarusian state medical university, Pediatric Infectious Diseases, Minsk, Belarus, ²Belarusian state medical university, Hygiene Of Children And Adolescents, Minsk, Belarus

Backgrounds: Congenital pneumonia leads to the death of 750,000 to 1.2 million newborns annually, which is about 10% of the world's child mortality.

Methods: 94 patients with congenital pneumonia were analyzed: full-term (n = 55) and preterm (n = 39) who were under observation in the Republican Scientific and Practical Center "Mother and Child" in Minsk

Results: The average gestational age of newborns in the compared groups was 39.02 weeks in full-term infants and 35.5 weeks in preterm infants. All preterm infants demanded intensive therapy, the average duration was 6.23 days, which was due to the extremely severe condition of most patients in this group at birth. In turn, 69.1% full-term newborns were in the OAR for an average of 4.25 days. It was found that preterm infants more often than full-term infants required resuscitation and artificial lung ventilation: 84.62% and 54.55%, respectively. At the same time, 64.1% preterm infants were put on mechanical ventilation from the first minutes of life, and for full-term infants - in 25.45% of cases. Microbiological study of the umbilical wound in 40% full-term newborns revealed hemolytic staphylococcus, in preterm infants - epidermal (18%) and hemolytic staphylococcus (15%).

Conclusions/Learning Points: Congenital pneumonia in preterm babies has severe course. Preterm newborns more often than full-term newborns need resuscitation measures due to the severity of their condition at birth and non-maturity.

EP168 / #1361

Topic: AS06. *Infections in early life / AS06.a. Congenital and perinatal infections*

PAENIBACILLUS THIAMINOLYTICUS MENINGITIS WITH ABSCESS AND ENCEPHALOMALACIA IN AN INFANT AND REVIEW OF LITERATURE.

E-Posters

E-POSTER VIEWING

Christy Tabarani, Manon Masson, James Murphy, Gloria Heresi, Roukaya Al Hammoud
University of Texas, McGovern Medical School, Pediatric Infectious Diseases, Houston, United States of America

Title of Case: Paenibacillus thiaminolyticus meningitis with abscess and encephalomalacia in an infant and review of literature.

Background: Paenobacillus thiaminolyticus (Bacillus thiaminolyticus) has not been known to be a virulent organism in humans. When isolated from clinical specimens, it is usually dismissed as harmless contaminant.

Case Presentation Summary: We present the first pediatric confirmed case of severe meningitis and cystic encephalomalacia due to P. thiaminolyticus. The patient is 5-week-old female infant, born at 36 weeks of gestational age, who presented with fever and seizure. CSF cultures grew P. thiaminolyticus (penicillin MIC 0.25, vancomycin MIC 16). Blood cultures were negative. MRI of the brain showed large cerebral abscesses with extensive necrotic encephalomalacia and communicating hydrocephalus within the first week of her presentation. (Fig) Patient had trans-fontanelle aspiration from one of the cerebral abscesses and yielded a mixture of CSF and necrotic tissue. (Fig) Cultures of this aspiration fluid were sterile however 16s ribosomal RNA sequencing was positive for P. thiaminolyticus. Invasive infections due Paenobacillus species tend to occur in patients with immunocompromise state and are very rare in infants.

Learning Points/Discussion: Paenibacillus thiaminolyticus can cause severe infections in infants and should not always be dismissed as a contaminant.

EP169 / #387

Topic: AS06. Infections in early life / AS06.a. Congenital and perinatal infections

SEXUAL DEVELOPMENT IN PERINATALLY HIV-INFECTED YOUNG PEOPLE: A SYSTEMATIC REVIEW AND EXPLORATIVE STUDY

E-Posters

E-POSTER VIEWING

Anne Marleen Ter Haar¹, Anouk Fieten¹, Malon Van Den Hof¹, Ellen Laan², Kim Oostrom³, Dasja Pajkr¹
¹Amsterdam University Medical Centre, Pediatric Infectious Diseases, Amsterdam, Netherlands, ²Amsterdam University Medical Centre, Amsterdam Reproduction & Development, Amsterdam, Netherlands, ³Amsterdam University Medical Centre, Paediatric Psychosocial Care, Amsterdam, Netherlands

Backgrounds: Similar to other young people with a chronic health condition, perinatally HIV-infected (PHIV) adolescents might have an impacted sexual development. This review and cross-sectional exploratory study aims to explore the occurrence and debut age of sexual milestones of PHIV and compare these to HIV uninfected controls. Sexual milestones include falling in love, having been in a romantic relationship, masturbation, kissing, non-genital caressing, genital caressing, oral sex, and penetrative sex (vaginal or anal).

Methods: We performed a systematic search in four electronic databases (Medline, Embase, Web of Science, and Scopus), according to the Preferred Reporting Items for Systematic Reviews and Meta-Analyses (PRISMA) guidelines. We included original studies that reported on quantitative data of sexual milestones of PHIV in comparison to an HIV uninfected control group. In the explorative study, we used a subset of questions of a validated questionnaire to compare sexual milestones of PHIV to a well-matched HIV uninfected group, matched for age, sex, ethnicity and educational level.

Results: We included eighteen studies in the systematic review describing nine distinct study populations. Five studies described significant differences in occurrence and/or debut age of milestones between PHIV and HIV- controls. In the explorative study, we included ten PHIV and sixteen HIV uninfected, matched controls. PHIV tended to report a later debut age of sexual milestones than HIV uninfected controls (not significant).

Conclusions/Learning Points: Young PHIV seem to engage in sexual activities and achieve sexual milestones at a similar rate as their uninfected peers, with a tendency of a later start in well treated PHIV. The numbers in both studies were small, therefore results must be interpreted carefully. While HIV is commonly transmitted through sex, it should remain an important topic in PHIV research and care.

EP170 / #1314

Topic: AS06. Infections in early life / AS06.a. Congenital and perinatal infections

NEONATES BORN TO MOTHERS INFECTED WITH SYPHILIS: A RETROSPECTIVE 7 -YEAR STUDY

E-Posters

E-POSTER VIEWING

Kleanthi Voutsadaki¹, Maria Tsirigotaki¹, George Niotakis¹, Maria Polichronaki¹, Fani Ladomenou², Marina Koropouli¹

¹Venizeleion General Hospital, Neonatal Intensive Care Unit, Heraklion, Crete, Greece, ²Venizeleion General Hospital, Pediatrics, Heraklion, Crete, Greece

Title of Case: NEONATES BORN TO MOTHERS INFECTED WITH SYPHILIS: A RETROSPECTIVE 7 YEAR STUDY

Background: Congenital syphilis (CS) still represents a worldwide public health problem despite preventive strategies. It can lead to high neonatal morbidity and mortality if left untreated. The risk of transmission in relation to the maternal stage of infection is highest during untreated primary or secondary syphilis.

Case Presentation Summary: A retrospective cohort study was performed including neonates born to mothers with reactive serologic test for syphilis during pregnancy from January 2015 until December 2021.

Learning Points/Discussion: A total of 4 newborns (3/4 males, median gestation age of 36 weeks, mean birth weight 2710gr) were investigated for CS. Mothers were all diagnosed with latent infection but only one had received appropriate therapy. One neonate (1/4, 25%) had positive serum non-treponemal titers, less than fourfold of the maternal titer. None of the neonates had positive treponemal IgM antibodies. Further evaluation was performed with complete blood count (4/4), liver function tests (4/4), cerebrospinal fluid analysis (CSF) (3/4), long bone radiographs (2/4), cranial ultrasound (4/4), ophthalmologic examination (3/4) and auditory brainstem responses (3/4). Most neonates (3/4, 75%) had no clinical or laboratory manifestations of CS. One neonate had rhinitis and CSF pleiocytosis. Neonates with possible CS were treated with intravenous crystalline penicillin G for 10 days (3/4, 75%). The neonate born to mother with adequately treated syphilis was treated with intramuscular benzathine penicillin G in a single dose. After discharge, all infants were followed with repeat non-treponemal titers until achieving non-reactive titers. CS can be effectively prevented by prenatal serologic screening of mothers and timely treatment of infected ones. Neonates born to mothers with reactive syphilis serology during pregnancy should be timely diagnosed and treated with appropriate antibiotics started early after delivery.

EP171 / #1079

Topic: AS06. Infections in early life / AS06.a. Congenital and perinatal infections

THE ROLE OF CRANIAL ULTRASONOGRAPHY AND MAGNETIC RESONANCE IMAGING IN CHILDREN WITH CONGENITAL CYTOMEGALOVIRUS INFECTION

E-Posters

E-POSTER VIEWING

Ivana Valenčak-Ignjatić¹, Diana Didović¹, Ante Šokota¹, Snježana Židovec Lepej¹, Nenad Šuvak², Goran Tešović¹

¹University Hospital for Infectious Diseases "Dr.Fran Mihaljević", Pediatric, Zagreb, Croatia, ²University Josip Juraj Strossmayer, Mathematics, Osijek, Croatia

Backgrounds: Congenital cytomegalovirus infection is the most common congenital viral infection worldwide. Brain involvement is the most serious manifestation of cCMV. Early identification of children at risk for long-term sequelae is important for adequate treatment and follow-up.

Methods: A retrospective study on children with confirmed cCMV infection born between January 2012 and January 2020 treated at University Hospital for Infectious Disease „Dr. Fran Mihaljević“, Zagreb, Croatia was conducted.

Results: A total of 30 children were enrolled in the study, 16 were classified as symptomatic. All children had available data on follow-up. The median age at the last evaluation was 3 years. cUS and brain MRI were performed in all included children. From 12 children without SNHL at birth – three had abnormalities on MRI and 1 developed delayed-onset SNHL. Epilepsy was diagnosed in 5 (16,6%) and cerebral palsy in 7 (23,3%) children, all had abnormalities in cUS and brain MRI. Motor impairment and speech disorders were observed more frequently in symptomatic children. Most of the children with motor impairment and speech disorders had abnormalities on MRI (87% and 83%, respectively). All children with asymptomatic infection that developed motor impairment had pathological MRI. Sequelae were more frequently observed in children with cCMV symptomatic infection, but only MRI abnormalities had consequential link with development of motor disorders (OR 17,5; 95% CI: 2,667, 114,846; p=0.002) and speech disorders (OR 15; 95% CI: 2,477, 90,843; p=0.02).

Conclusions/Learning Points: Both symptomatic and asymptomatic children with cCMV are at risk for long-term sequelae. Neuroimaging, especially brain MRI, is the best tool for predicting outcome in affected children. More studies should be done before establishing MRI as an obligatory part of routine evaluation in asymptomatic children with normal cUS.

EP172 / #1428

Topic: AS06. Infections in early life / AS06.a. Congenital and perinatal infections

**GROUP B STREPTOCOCCUS COLONIZATION IN PREGNANT WOMEN AND NEONATES:
INCIDENCE AND RISK FACTORS**

E-Posters

E-POSTER VIEWING

Kalliopi Vardaki¹, Despoina Gkentzi², Emmanouel Karavitakis³, Sofia Maraki⁴, Emmanouil Galanakis¹, Eleftheria Hatzidaki¹

¹University of Crete, Postgraduate Course "vaccines And Prevention Of Infectious Diseases", Heraklion, Greece, ²University Hospital of Patras, Department Of Pediatrics, Patras, Greece, ³General Hospital of Chania, Neonatal Intensive Care Unit, Chania, Greece, ⁴University Hospital of Heraklion, Department Of Microbiology, Heraklion, Greece

Backgrounds: Group B Streptococcus (GBS) infection is a significant cause of neonatal morbidity and mortality. The neonatal disease is divided into early-onset attributed to vertical transmission from a colonized mother and late-onset disease. Universal screening, including rectovaginal culture swabs and peripartum prophylaxis administration to GBS+ women, is a useful tool to prevent early-onset disease. The colonization rate varies worldwide and data in Greece are scarce. The aim of this study was to determine GBS colonization rate in our region.

Methods: All pregnant women and their newborns in two major hospitals of Crete from 2015 to 2019 were retrospectively included in the study. GBS colonization by vaginal cultures was evaluated and potential risk factors (age, nationality, residence area, multiparity, comorbidities, visits, gestational age when culture performed, mode of delivery) were recorded. The rates of antibiotic prophylaxis and neonatal disease were, also, assessed.

Results: A total of 7,362 pregnant women was reviewed, 4,984 (67.7%) underwent screening and 83 (1.7%) were colonized by GBS. Most of GBS+ women (34.9%) were 31-35 years old, 45.8% examined early in gestation (<35th week) and only 9.6% appeared to have comorbidities (diabetes, hypertension). Multiparity (³2) was associated with colonization in 66.3%, whereas other factors were not determinant. All GBS+ women were given peripartum prophylaxis and none of their newborns developed disease. Nevertheless, from the rest of neonatal population, 3 developed early and 1 late-onset disease.

Conclusions/Learning Points: GBS colonization in our area is among the lowest reported. Peripartum antibiotic prophylaxis seems to sufficiently prevent transmission, but there is still morbidity. Thus, not only better compliance to recommendations, but also more effective prevention strategies, including maternal vaccination, are needed.

EP173 / #308

Topic: AS06. Infections in early life / AS06.a. Congenital and perinatal infections

BALANCE ISSUES IN CONGENITAL CYTOMEGALOVIRUS: A CASE SERIES OF PATIENTS FROM A SINGLE UK CENTRE

E-Posters

E-POSTER VIEWING

Georgina Yan¹, Annalie Shears², Rob Low³, Katy Fidler¹

¹Royal Alexandra Children's Hospital, Paediatrics, Brighton, United Kingdom, ²Royal Manchester Children's Hospital, Paediatrics, Manchester, United Kingdom, ³University Hospitals Sussex NHS Trust, Audiology, Brighton, United Kingdom

Title of Case: Balance Issues in Congenital Cytomegalovirus

Background: Congenital CMV (cCMV) is the leading non-genetic cause of sensorineural hearing loss (SNHL) worldwide. Only 10% are symptomatic at birth with signs including microcephaly, small for gestational age, widespread petechiae and hepatosplenomegaly. SNHL may present in the neonatal period or in later life in both symptomatic and asymptomatic cases. Other long-term complications include developmental delay, seizures, vision loss and vestibular dysfunction, the latter is often under-recognised..

Case Presentation Summary: We conducted a retrospective case note review of patients diagnosed with cCMV over 14 years, 2007 to 2021, at a single UK children's hospital. 18 patients were identified: 11 presented with symptoms, 5 were tested after failing the newborn hearing screening programme, 1 asymptomatic baby was tested after known maternal seroconversion in pregnancy and 1 was tested in error. Regarding outcomes: 14/18 patients received ganciclovir/valganciclovir therapy. To date 11/18 have SNHL. 6/18 have balance disturbance of whom, 5 have hearing loss. 2 have peripheral vestibular dysfunction. 1 has difficulties with proprioception, 1 has episodic vestibular imbalance with abnormal vestibules on imaging and 1 has difficulty with balance control despite having normal hearing and peripheral vestibular function. 1 is awaiting formal vestibular assessment. 7/18 have general developmental delay of whom, 2 have severe cerebral palsy. 6/18 have epilepsy. 2/18 have autism. 1 has ADHD with anxiety and behavioural difficulties, 1 has severe behavioural difficulties and 1 has cerebral visual impairment

Learning Points/Discussion: This case series highlights the importance of follow up for babies with cCMV and demonstrates that vestibular/balance problems are found in one third. A collaborative national approach is essential to determine the natural progression of this disease and the efficacy of early antiviral treatment on all long-term sequelae.

EP174 / #828

Topic: AS06. Infections in early life / AS06.b. Neonatal sepsis

VERY LATE ONSET SEPSIS BY GROUP B STREPTOCOCCUS-RARE BUT IMPORTANT TO DIAGNOSE ENTITY

E-Posters

E-POSTER VIEWING

Afroditi Barmpakou, Ifigeneia-Dimitra Matara, Marialena Liagakaki, Simoni Gregoriou, Konstantinos Kakleas, Antina Santou
Aghia Sophia Children's Hospital, First Department of Pediatrics, General Paediatrics, Athens, Greece

Title of Case: VERY LATE ONSET SEPSIS BY GROUP B STREPTOCOCCUS-RARE BUT IMPORTANT TO DIAGNOSE ENTITY

Background: Very late onset Group B Streptococcus (GBS) sepsis occurs in infants older than 90 days and mainly presents as bacteremia and/or meningitis.

Case Presentation Summary: A three-month-and-one-week-old female presented with a 48-hour history of fever and diarrhea. She was born at term via vaginal delivery. GBS status at pregnancy was unclear. The baby on admission was febrile, tachycardic and irritable, with bulging anterior fontanelle and dilated abdomen. A full septic screen was performed and she was started on intravenous cefotaxime. Cerebrospinal fluid (CSF) microscopy and biochemistry were normal. Teicoplanin was added to the antibiotic treatment, to cover the possibility of staphylococcal infection. In less than 12 hours, blood culture was positive for gram positive cocci in chains and film array revealed GBS. The CSF culture was positive for GBS as well. Cranial ultrasound was performed within the first 48 hours of admission that showed increased echogenicity of subarachnoid space and the meninges. A cardiac echo was also performed that was normal. The baby continued to remain febrile for 72 hours after the onset of antibiotic treatment in which GBS was sensitive and subsequently fever subsided. A CT scan of the brain was also performed and did not reveal gross brain pathology. The initial hearing screening was normal. The infant has completed 21 days of intravenous antibiotic treatment. At present, there are no obvious neurological deficits, nevertheless follow-up has been arranged.

Learning Points/Discussion: GBS very late onset sepsis and meningitis is less common than early and late onset sepsis, though still serious and requires prompt recognition and appropriate management.

EP175 / #629

Topic: AS06. Infections in early life / AS06.b. Neonatal sepsis

CLINICAL AND MICROBIOLOGICAL PROFILE OF PERSISTENT COAGULASE-NEGATIVE STAPHYLOCOCCAL BACTERAEMIA IN NEONATES

E-Posters

E-POSTER VIEWING

Venetia Bellou¹, Despoina Gkentzi¹, Nikolaos Giormezis², Iris Spiliopoulou², Gabriel Dimitriou¹

¹Patras Medical School, University of Patras, Department Of Paediatrics, Patras, Greece, ²Patras Medical School, University of Patras, Department Of Microbiology, Patras, Greece

Backgrounds: An atypical pattern of Coagulase-negative staphylococci (CoNS) sepsis, characterized by persistence despite antibiotic therapy, has been described in neonates in NICUs. Our aim was to analyze the clinical, microbiological and molecular determinants of neonates with persistent CoNS bacteraemia in our NICU in Greece with the view of assessing trends over time.

Methods: Neonates with late-onset CoNS bacteraemia were studied over a 2-year period 2016-2017 and compared with 2006-2007. Demographics, clinical, laboratory, microbiological and molecular data were compared between neonates with persistent (3 consecutive positive blood cultures) and non-persistent CoNS bacteraemia.

Results: Overall, 128 cases of episodes of CoNS bacteraemia were recorded. During 2006-2007, 29(40%) cases with persistent and 43 with non-persistent bacteraemia, whereas, during 2016-2017, 14(25%) cases with persistent and 42 cases with non-persistent were identified. There were no significant differences in demographic characteristics throughout the two study periods. In both periods, the most commonly isolated microorganism was *S.epidermidis*. The *ica* operon was most commonly found in CoNS isolates in 2006-2007 for both persistent and non-persistent bacteraemia versus 2016-2017 ($p=0.001$, and $p=0.000$ respectively). In the persistent bacteraemia group, 68 CoNS isolates (70,1%) showed biofilm production the period 2006-2007, and 50 (53,5%) the period 2016-2017 ($p=0.020$). In the non-persistent bacteraemia, 39 CoNS isolates (53,4%) showed biofilm production the period 2006-2007, and 26 (35,1%) the period 2016-2017 ($p=0.026$). In a logistic regression model, biofilm production was identified as a major determinant of the persistent disease in both periods 2006-2007($p=0.004$) and 2016-2017($p=0.042$).

Conclusions/Learning Points: The incidence of persistent CoNS bacteraemia decreased within a period of ten years which may be attributed to the implementation of infection control policies. Biofilm production remains the most significant microbiological risk factor for the development of persistent bacteraemia.

EP176 / #978

Topic: AS06. Infections in early life / AS06.b. Neonatal sepsis

EDWARDSIELLA TARDA MENINGITIS WITH SEPSIS IN A 2 MONTH OLD INFANT FOLLOWING NEUROSURGICAL INTERVENTION

E-Posters

E-POSTER VIEWING

Praveena Bhaskaran¹, Suhas Udayakumaran²

¹Amrita Institute of Medical Sciences, Infectious Diseases, Kochi, India, ²Amrita Institute of Medical Sciences, Neurosurgery, Kochi, India

Title of Case: Edwardsiella tarda meningitis with sepsis in a 2 month old infant following neurosurgical intervention

Background: Edwardsiella tarda, a member of the family enterobacteriaceae, is associated with freshwater environment and marine animals. It usually causes gastroenteritis, and rarely extra-intestinal manifestations in adults like abscesses, osteomyelitis, meningitis and septicemia, especially in those with underlying conditions. There have been very few case reports among pediatric patients, with the organism mainly causing septicemia, meningitis and brain abscess resulting in high morbidity and mortality. The main portal of entry is gastrointestinal tract and skin inoculation, but maternal chorioamnionitis causing neonatal infection has also been described. Here, we report a 2 month old infant, who developed Edwardsiella tarda meningitis and sepsis, 2 weeks following endoscopic septum pellucidotomy done for congenital hydrocephalus.

Case Presentation Summary: 2 month old exclusively breast fed female infant presented with fever, irritability and poor feeding of 2 days duration. She had undergone endoscopic septum pellucidotomy for congenital hydrocephalus 2 weeks prior to the presentation. Her CSF showed pleocytosis with 400 cells/mm³, glucose of 29 mg% and protein of 103 mg%. CSF and blood culture grew Edwardsiella tarda sensitive to most antibiotics tested. She was empirically started on meropenem which was given for 7 days followed by ceftriaxone which was given for 7 more days. Parents reported having a fish farm rearing Tilapia at home. The patient's mother was asymptomatic, and her stool culture was negative. The water sample from the fish pond was also cultured and was negative. MRI brain showed hydrocephalus with slight decrease in the dimensions compared to preoperative period. Primary immunodeficiency work up was negative.

Learning Points/Discussion: Edwardsiella tarda is a rare cause of meningitis and septicemia in young infants with high morbidity and mortality.

EP177 / #451

Topic: AS06. Infections in early life / AS06.b. Neonatal sepsis

PRIMARY BLOODSTREAM INFECTIONS IN A NEONATAL ICU: THREE-YEAR ANALYSIS.

E-Posters

E-POSTER VIEWING

Victor Hugo Bota Rodrigues, Maria Regina Bentlin

São Paulo State University (Unesp), Medical School, Botucatu, Paediatrics Department, Botucatu, Brazil

Backgrounds: Primary bloodstream infections (PBI) are responsible for high morbidity and mortality in newborns.

Methods: A retrospective cohort study, performed at the Neonatal Intensive Care Unit (NICU) – Clinics Hospital - Botucatu Medical School (UNESP), between 2014 - 2016, after approval by the Ethics Committee. Inclusion criteria: newborns with PBI and positive blood culture after 72 hours of life. Criteria for non-inclusion: contaminants and growth of coagulase negative staphylococci (SCoN) in only one blood culture. The sample consisted of 70 newborns with 71 positive blood cultures. Outcomes: septic shock and death. The agents were compared in groups: Gram-positive and Gram-negative. Statistical analysis: descriptive and comparison between groups with parametric and non-parametric tests, with statistical significance of 5%.

Results: The incidence of PBI was 10.2%, being 58% for Gram-positive, 39% for Gram-negative and 3% for fungi. Mortality was 22.8% and death directly related to the PBI occurred in 10% of Gram-positive and 14% of Gram-negative. SCoN were the most frequent Gram-positive, but *S. aureus* was the most frequently evolved to shock (39%). Among Gram-negative, 59% evolved to shock. Regarding antimicrobial resistance, 88% of SCoN were resistant to oxacillin, but most *S. aureus* were sensitive to it. Among Gram-negatives, *Enterobacter cloacae* was the most frequent and 33% of them were resistant to aminoglycosides. There were 3 cases of PBI per Gram-negative ESBL producer.

Conclusions/Learning Points: Gram-positive were the most frequent. Among Gram-positive, SCoN were the most found and *S. aureus* was the most to shock and death. Among Gram-negative more than half evolved to shock. NICU's empirical therapy should be maintained since the most severe Gram-positive agents are oxacillin-sensitive and most Gram-negative agents are sensitive to aminoglycosides.

EP178 / #457

Topic: AS06. Infections in early life / AS06.b. Neonatal sepsis

USING RISK SCORING FOR THE PREVENTION OF NEONATAL SEPSIS: AUDIT AND QUALITY IMPROVEMENT PROJECT

E-Posters

E-POSTER VIEWING

Jonathan Broad¹, Micha Thomas², Veerakorn Achakulwisut², Clare Gollop¹, Jo Sullivan¹, Jonathan Filkin¹, Ben Ummat¹

¹Kingston Hospital, Paediatrics, London, United Kingdom, ²Kingston Hospital, Paediatrics, QB, United Kingdom

Backgrounds: Sepsis remains a leading cause of death in neonates, and a range of antibiotic strategies are available to prevent it. National UK guidance is to treat all infants with two or more risk factors. In this presentation we discuss a quality improvement project adopting risk scores, in line with a regional strategy for sepsis prevention.

Methods: National (NICE) guidelines suggest treatment of all infants with two or more maternal and neonatal risk factors, including prolonged rupture of membranes, prematurity, maternal untreated colonisation. The new system, adapted from the Kaiser Permanente initiative, uses a baseline incidence and attributes a weighted score based on risk factors and clinical exam. The probability of sepsis is calculated if a newborn has a normal, equivocal, or unwell clinical exam, and guides whether the infant needs routine vitals, investigation and /or treatment.

Results: At baseline, using NICE guidelines the majority of infants that were treated did not have positive cultures, C-reactive protein or indicators of infection. Baseline incidence of 0.8 episodes of sepsis per 1000 live births was adopted based on regional data. In this quality improvement, we undertook several interventions. We conducted scoping, discussion with key stakeholders, and established a universal scoring system. We drafted guidelines, and adapted with feedback from maternity and paediatric departments. We piloted the tool with midwives. We gave departmental presentations and made educational flowcharts and posters. Follow-up data will be presented.

Conclusions/Learning Points: Using risk factors as an approach prevents the majority of potential infections, although contributed to overtreatment, prolonged hospital stays and exposure to antibiotics for well infants. New systems require a range of change initiatives. Sepsis risk scoring that includes clinical examination has the potential to target those at highest risk

EP179 / #1411

Topic: AS06. Infections in early life / AS06.b. Neonatal sepsis

CYTOMEGALOVIRUS SEROPOSITIVE MOTHERS' BREAST MILK USE IN EXTREME PREMATURITY OR VERY LOW BIRTH WEIGHT– REVIEW OF DIFFERENT INTERNATIONAL NEONATAL ORGANISATIONS ADVICE AND APPROACH IN DIFFERENT COUNTRIES

E-Posters

E-POSTER VIEWING

Lynne Carty, Hermione Lyall

Imperial Healthcare NHS Trust, Paediatric Infectious Diseases, London, United Kingdom

Backgrounds: Postnatally acquired cytomegalovirus (CMV) infection is most likely to be transmitted via breastmilk. CMV is reactivated by mammary glands during lactation. In the premature baby or very low birthweight (VLBW), CMV can cause sepsis-like syndrome, hepatitis, pneumonitis, thrombocytopenia and neutropenia. Freezing, pasteurising, UV-irradiation and microwave-irradiation have been shown to reduce CMV in breast milk by varying degrees. However these processes also reduce beneficial nutritional, immunological, and endocrinological properties in breast milk. Reduction in these properties can have an adverse impact on growth and increase the risks of neonatal complications such as infection and NEC. This leads to the question of best management of premature babies with mothers who are CMV IgG seropositive.

Methods: We carried out a literature review of guidelines and approaches in different countries. Search terms used: (CMV or cytomegalovirus) and (neonate or prematur* or "low birthweight" or VLBW) and (milk or breastmilk or "breast milk" or feed*)

Results:

Guidelines regarding use of breast milk to reduce postnatal CMV infection

| Country | Gestation/BW | Raw colostrum | Fresh milk | Frozen milk | Pasteurised milk |
|-----------------------|----------------------------------|---------------|---------------------|-----------------------|-----------------------|
| USA | <32 weeks | | Yes | Consider risk/benefit | Consider risk/benefit |
| France | <32weeks/ <1500g | | No | No | Yes |
| Austria | <35 weeks | no | no | no | yes |
| Spain | <1500g | Yes | Yes for first weeks | Yes after first week | No |
| Sweden (updated 2016) | < 28weeks (previously <32 weeks) | Yes | Yes | No | No |

National guidelines found in this literature search varied depending on the perceived risk of CMV infection vs the benefits of fresh maternal milk. Not all countries have a national guideline, instead using regional and local guidelines to guide management.

Conclusions/Learning Points: Postnatally acquired CMV infection poses potentially significant risk in extreme prematurity or VLBW. Currently the way to reduce this risk involves modifying breast milk at a cost of the milk's protective benefit. There is currently no agreed consensus internationally. More research into the risks and benefits of using fresh maternal milk is required to help formulate guidelines to inform management in this area.

EP180 / #1935

Topic: AS06. Infections in early life / AS06.b. Neonatal sepsis

INFANT SEPSIS AND MENINGITIS SECONDARY TO SALMONELLA. A CASE REPORT

E-Posters

E-POSTER VIEWING

Maria Castillo, Sonia Matthews, Samanta Catueño, Guyu Li
Texas A&M School of Medicine, Post Graduate Education, Driscoll Children's Hospital, Pediatrics, Corpus Christi, United States of America

Title of Case: Infant sepsis and meningitis secondary to salmonella. A case report.

Background: The diagnoses of meningitis and sepsis due to *Salmonella* spp in infants are not very common, and their late diagnosis can generate life-threatening complications or significant neurological sequelae. Clinical characteristics are similar to other gram-negative microorganisms infections, and the mode of transmission in this patient is not completely established. The best diagnostic method is through the growth of the organism in the blood culture and cerebrospinal fluid, while the treatment includes the use of intravenous antibiotics for a period of 4 to 6 weeks.

Case Presentation Summary: A 4-week-old female presented to the emergency room with emesis, irritability, and fever for 1 day, with a rectal temperature of 38.3°C. A sepsis workup was initiated, and the CSF indicated bacterial meningitis. The patient was admitted to the pediatric intensive care unit, and treatment was initiated with intravenous Ampicillin and Cefepime. On day 3, a pansensitive *Salmonella* spp. was isolated from the blood and CSF culture, and the antibiotic treatment was changed to Ceftriaxone. On day 8, the second LP was performed, the CSF analysis revealed significantly improved leukocytosis, and the CSF culture was negative. A 5-week course of IV Ceftriaxone was completed, no neurological deficits were found, and the patient was discharged home on day 35 with close follow-up with her pediatrician.

Learning Points/Discussion: The mother was interviewed to trace the source of *Salmonella* spp, stating that she did not present any symptoms and had not been in contact with other people. This case highlights the importance to take salmonella into consideration when patients arrive with suspicious symptoms. Making an early diagnosis through blood culture and CSF analysis is the beginning of a successful treatment plan.

EP182 / #830

Topic: AS06. Infections in early life / AS06.b. Neonatal sepsis

FUNGAL SEPSIS AND ANTIFUNGAL PROPHYLAXIS – HOW ARE WE DOING? – A UK NEONATAL UNIT'S EXPERIENCE IN COMPARISON TO NICE GUIDELINE

E-Posters

E-POSTER VIEWING

Suman Fathima, [Naomi Cobbold](#), Vennila Ponnusamy

St Peter's hospital, Ashford and St Peter's Hospitals NHS foundation trust, Neonatal Intensive Care Unit, Chertsey, United Kingdom

Backgrounds: In 2021, NICE, UK updated the guidelines for prophylactic usage of antifungals in preterm infants during antibiotic treatment for late-onset neonatal infection. The recommendation is to use oral Nystatin where feasible to reduce fungal resistance to fluconazole.

Methods: Objective: To analyse the characteristics of fungal septicemia in our neonatal intensive care unit (NICU) to review our practice of using fluconazole for fungal prophylaxis in <1000 g. Methods: Retrospective analysis using electronic patient record of all neonates with fungal sepsis admitted to our NICU over 8.5 years from April 2013 to October 2021.

Results: In total 23 babies had fungal sepsis, of which 87% were <30 weeks gestation or <1500 g birth weight. The mean birth weight was 983 g (IQR:635-1056g) and mean gestational age was 27 weeks (IQR:24+1-27+5). Majority of the fungal sepsis was from urine (18) compared to blood culture (6) with one baby having growth in both. Commonest growth was *Candida albicans* (83%). The fluconazole treatment varied from 5 days to 5 weeks with additional use of amphotericin in two babies. Average duration of hospital stay was 84 days with four babies (4/22) dying before discharge home. Antifungal prophylaxis was received by 11/21 babies. Of the remaining 10 babies who did not receive antifungal prophylaxis, six babies did not meet our NICU criteria (<1000g weight) for receiving prophylaxis and the remaining four have been missed.

Conclusions/Learning Points: Conclusion: Our data demonstrate that fungal sepsis is more common in babies with birth weight <1500g or preterm <30weeks' gestation. Only 2/3rd of these babies were covered with antifungal prophylaxis with our current criteria. We recommended strict adaptation of NICE guidelines for antifungal prophylaxis to reduce the incidence of fungal septicemia.

EP184 / #514

Topic: AS06. Infections in early life / AS06.b. Neonatal sepsis

LATE ONSET SEPSIS IN VERY LOW BIRTH WEIGHT PRETERM INFANTS: A 10-YEAR REVIEW FROM A BRAZILIAN TERTIARY UNIVERSITY HOSPITAL.

E-Posters

E-POSTER VIEWING

Ludmila Gerios, Victor Hugo Bota Rodrigues, Maria Regina Bentlin
São Paulo State University (Unesp), Medical School, Botucatu, Paediatrics Department, Botucatu, Brazil

Backgrounds: Despite technological advances and improvement in neonatal care, sepsis is still a daily challenge faced by neonatologists because of its frequency and severity. The objectives of the study were: In very low birth weight preterm infants (VLBW), to assess the incidence of clinical and proven late onset sepsis (LOS), the risk factors associated and the short term prognosis.

Methods: A cohort study of 752 VLBW preterm infants, admitted to the NICU and surviving over 72 hours, from 2008-2017. LOS was defined as clinical and laboratory signs of infection, either confirmed or not by blood culture. Patients were compared in groups: No LOS vs. Proven LOS vs Clinical LOS. Statistical analysis: ANOVA with multiple Tukey or Wald comparison with gamma distribution; multiple logistic regression model in stepwise, with adjustment for year and gestational age.

Results: The incidence of LOS was 39% (proven LOS 29%; clinical LOS 10%). Septic VLBW had higher mortality (proven LOS 23,2%; clinical LOS 41,9%; No LOS 8,9%). The most frequent agents were coagulase negative staphylococci (56%), Gram-negative (26%) and Fungi (8%). Comparing the groups, septic VLBW were lower in gestational age and birth weight, had more morbidities and invasive procedures. The most important risk factors for proven and clinical LOS were days of mechanical ventilation and days of parenteral nutrition. Proven and clinical LOS increased the risk of death, bronchopulmonary dysplasia, severe intraventricular hemorrhage and retinopathy of prematurity.

Conclusions/Learning Points: Conclusions: The incidence and mortality of LOS were high. Care practices, specially mechanical ventilation and parenteral nutrition were the main risk factors. LOS had a major negative impact on short prognosis of VLBW. Strategies for LOS reduction are necessary and urgent.

EP185 / #720

Topic: AS06. Infections in early life / AS06.b. Neonatal sepsis

NEONATAL RSV POSTIVE BRONCHIOLITIS WITH FULMINANT VIRAL SEPTIC SHOCK ASYSTOLE DISSEMINATED INTRAVASCULAR COAGULATION AND PULMONARY HAEMORRHAGE

E-Posters

E-POSTER VIEWING

Zakir Hussain Gulam Ghouse, Amanda Diaz Rodriguez, Mehwish Javed, Muhammad Akram
St Lukes hospital, Paediatrics, Kilkenny, Ireland

Title of Case: NEONATAL RSV BRONCHIOLITIS COMPLICATIONS 1 month old girl, unwell for 2 days with cough, decrease oral intake, seen by gp in the morning was diagnosed as bronchiolitis. Same evening presented to the hospital with apnoea in the car and arrived at PAU within 3 mins of apnoea.

Background: O/E: No HR or breathing, bleeding from nose and mouth, pale looking, CRT 5 seconds, mottled, and absent pulses, asystole on monitor. Immediate cardiac arrest call was activated. CPR started, baby intubated, cannulas inserted, 2 doses of adrenaline and 30ml/kg of NS bolus given, partial septic screening done, started on triple antibiotics amoxicillin, cefotaxime, gentamicin. After 10 minutes of CPR and adrenaline, HR >100, pulses palpable, CRT improved to 3 sec. Vit K IV was given and then transfused with O negative blood & FFP. Blood gas showed mixed metabolic and respiratory acidosis PH 6.9, PCO2 12.9, HCO3 11.8, BE -16.8 and connected to ventilator. Started on morphine infusion, IV fluids, Lasix. Transferred to tertiary center, admitted for 11 days. Extubated to CPAP day 5 weaned to high flow day 6, and RA on day 9. Inotropes for 24 hours. Acyclovir, vitamin K for 9, 6 days respectively. Neuroprotective measures followed. Investigations: RSV positive, covid 19 negative, blood c/s, CSF C/s, viral and bacterial PCRs negative. CXR consolidation upper lobes of lungs, CT angiogram subsegmental consolidation and possible intraparenchymal haemorrhage. Initial Echo pulmonary hypertension, and repeat echo normal, MRI Brain- hypersensitivity in posterior putamina. Deranged COAGs: APTT >180, PT 16.2, INR 1.4.

Case Presentation Summary: Main purpose of presenting this clinical case is that RSV positive bronchiolitis can present with asystole, septic shock, pulmonary haemorrhage, DIC, and lobar pneumonia.

Learning Points/Discussion: RSV positive bronchiolitis with all complications can mimic bacterial sepsis

EP186 / #1235

Topic: AS06. Infections in early life / AS06.b. Neonatal sepsis

PAENIBACILLUS INFECTION CAUSES NEONATAL SEPSIS AND SUBSEQUENT POSTINFECTIOUS HYDROCEPHALUS IN UGANDAN INFANTS

E-Posters

E-POSTER VIEWING

Christine Hehnly¹, Sarah Morton², James Broach¹, Joseph Paulson³, Steven Schiff⁴

¹Penn State College of Medicine, Institute For Personalized Medicine, Hershey, United States of America, ²Harvard Medical School, Division Of Newborn Medicine, Boston Children's Hospital And Department Of Pediatrics, Boston, United States of America, ³Genentech Inc, 27 department Of Biostatistics, Product Development, San Francisco, United States of America, ⁴Pennsylvania State University, Center For Neural Engineering, Department Of Engineering Science And Mechanics, University Park, United States of America

Backgrounds: Paenibacillus thiaminolyticus is an important contributor to postinfectious hydrocephalus (PIH) among Ugandan infants, presumably as a sequela from prior neonatal sepsis (NS). To better determine this organism's role in NS and PIH, we studied Ugandan infants with hydrocephalus (case-control, with and without infection), as well as maternal-newborn pairs (case-control, with and without maternal fever), and a cohort of neonates with sepsis.

Methods: From 2016-2019, 400 infants with hydrocephalus were recruited. 16S rDNA sequencing was used to characterize the bacterial content of infant cerebrospinal fluid (CSF). Quantitative polymerase chain reaction (qPCR) of Paenibacillus was also performed. One hundred maternal-newborn pairs and 800 neonates with sepsis were recruited and samples were evaluated for Paenibacillus with qPCR. In addition, cranial ultrasound and computed tomography images were collected.

Results: Paenibacillus was the most enriched bacterial genera in PIH CSF (44%), with 16S demonstrating 94% accuracy when validated by qPCR. No Paenibacillus was detected in vaginal, maternal blood, placental, or cord blood specimens. Paenibacillus was detected in 5% of septic neonates, and of these 19% developed PIH. Imaging demonstrated progression from Paenibacillus meningitis to PIH over months. PIH patients with Paenibacillus infections were geographically clustered.

Conclusions/Learning Points: Paenibacillus causes neonatal sepsis and meningitis in Uganda and is the dominant cause of subsequent PIH. There was no evidence of transplacental transmission, and geographical evidence was consistent with an environmental source of neonatal infection. Further work is needed to identify routes of infection and optimize the treatment of neonatal Paenibacillus infection to lessen the burden of morbidity and mortality.

EP187 / #64

Topic: AS06. Infections in early life / AS06.b. Neonatal sepsis

2 CASES REPORT: NEONATAL HERPES SIMPLEX VIRUS INFECTION TYPE 1

E-Posters

E-POSTER VIEWING

Puthe Laing

Armand Trousseau Hospital, Neonatology, Paris, France

Title of Case: NEONATAL HERPES SIMPLEX VIRUS INFECTION TYPE 1

Background: Two cases of neonatal herpes simplex virus infection type 1 were diagnosed at the neonatology department at Armand Trousseau Hospital in France.

Case Presentation Summary: Severe but relatively rare, neonatal herpes simplex virus infection shows marked mortality so that immediate management is considered to deduct the death rate and neurosensory complications of neonates. Two cases of herpes simplex virus type 1 infection in newborns are reviewed with the mean of diagnosis and management. The first one had been diagnosed as skin and mouth disease that was recurrent as meningoencephalitis even after treated by immunosuppressive therapy. The second scenario was about disseminated form which includes lungs and central nervous system. Acyclovir therapy is a choice of treatment according to the recent recommendation in the context of a suspect of herpes infections in terms of clinical aspects and even during the pending of paraclinical results for a better neurosensory outcome.

Learning Points/Discussion: Herpes simplex virus infection in newborn is a life-threatening disease. Pediatricians as well as neonatologists need to pay attention in making differential diagnosis. Mostly, no recorded medical histories from the mothers, but neonates are required to be treated immediately when there are suspects of HSV infections in terms of clinical aspects during the pending of laboratory and imaging profiles. IV acyclovir is recommended with the continuation of oral suppressive therapy. Short and long terms outcomes are associated to the duration of antiviral therapy and the compliance of the management.

EP188 / #1297

Topic: AS06. Infections in early life / AS06.b. Neonatal sepsis

SURVEILLANCE OF METHICILLIN-SUSCEPTIBLE STAPHYLOCOCCUS AUREUS COLONIZATION AND INFECTIONS IN A NEONATAL INTENSIVE CARE UNIT.

E-Posters

E-POSTER VIEWING

Ludo Mahieu¹, Anneleen Engelen², Veerle Matheussen³, Antonius Mulder¹

¹University Hospital Antwerp, Neonatology, Edegem, Belgium, ²University Hospital Antwerp, Pediatrics, Edegem, Belgium, ³University Hospital Antwerp, Clinical Microbiology, Edegem, Belgium

Backgrounds: Methicillin sensitive *Staphylococcus aureus* (MSSA) is the second most common hospital acquired infection in neonatal intensive care unit (NICU) patients. Most studies in NICUs are focused on methicillin-resistant *Staphylococcus aureus*. Data on MSSA colonization and the association with severe MSSA infection are limited and lack for noninvasive infections in the NICU population.

Methods: This is a single center retrospective cohort study in a NICU of the Antwerp University Hospital, Belgium. All neonates (n= 366) admitted between November 1, 2020, to October 31, 2021 were enrolled. All patients were screened, weekly until discharge, for MSSA colonization at throat, nose, perineum and groin using flocked swabs in liquid Amies medium and applying standard microbiological culture techniques. All MSSA infections were recorded and classified as noninvasive (conjunctivitis, rhinitis, wound) or invasive (bloodstream, lower respiratory tract) infection.

Results: During the study period, 338 NICU patients were screened for MSSA colonization ([56%] male); 11% with gestation below 28weeks (ELGAN), 27% with birthweight <1500g; median length of stay 10 (IQ range 5-25) days. The overall incidence of MSSA colonization during hospitalization was 40% (136/338) and 76% in ELGAN ($\chi^2 22.8$, $P < 0.01$), with a median postnatal onset at day 14 (IQ range 7-31) days. The overall incidence of MSSA infection was 13.0% (49/338), noninvasive 10.6%; invasive 2.6%. Colonization with MSSA in neonates was associated with MSSA infection overall (OR, 16.7; 95% CI, 7.03-49.2; $P < 0.001$), noninvasive MSSA infections (OR, 67.3; 95% CI, 9.11-496; $P < 0.001$) and with invasive MSSA infection (OR, 2.89; 95% CI, 0.85-9.78; $P = 0.08$).

Conclusions/Learning Points: This study illustrates that MSSA colonization is frequent in NICU patients and that it is associated with subsequent MSSA infections, both for noninvasive but less for invasive infections. More studies are needed to identify risk factors for MSSA colonization in NICU patients.

EP189 / #313

Topic: AS06. Infections in early life / AS06.b. Neonatal sepsis

DAPTOMYCIN FOR TREATMENT OF S. EPIDERMIDIS ENDOCARDITIS IN AN EXTREMELY PRETERM NEONATE – OUTCOME AND PERSPECTIVES

E-Posters

E-POSTER VIEWING

Chiara Minotti¹, Ilaria Zuccon¹, Elena Priante², Luca Bonadies², Costanza Di Chiara¹, Daniele Donà¹, Eugenio Baraldi², Paola Costenaro¹

¹University of Padua, Paediatric Infectious Diseases, Padova, Italy, ²University Hospital of Padua, Neonatal Intensive Care Unit, Padua, Italy

Title of Case: Daptomycin for treatment of *S. epidermidis* endocarditis in an extremely preterm neonate – Outcome and perspectives

Background: Infective endocarditis is described in neonates with predisposing factors (congenital cardiac diseases, prolonged hospitalization in Intensive Care Units, central venous lines, prematurity, prolonged parenteral nutrition). Diagnosis and treatment are challenging, with a greater difficulty to isolate pathogens from blood cultures. Off-label daptomycin can be considered for prolonged therapy for its bactericidal effect and biofilm penetration.

Case Presentation Summary: A newborn born at 24 weeks, 550 g, presented on DOL 18 a late-onset sepsis episode. Intravenous vancomycin and ceftazidime were started empirically. Blood cultures were positive for Methicillin-resistant *Staphylococcus epidermidis* and *S. capitis* susceptible to vancomycin (MIC ≤ 0.5). A further raise of CRP with septic appearance was observed five days later. On DOL 26 meropenem and micafungin were started. Multiple cultures resulted positive for MRSE with increased vancomycin MIC (MIC = 2). An echocardiography was performed, confirming the diagnosis of infective endocarditis. Daptomycin was started off-label (MIC = 0.5), at 6 mg/kg twice daily, with an optimal tolerance profile for six weeks and clinical cure. Four weeks after therapy discontinuation, there were no identifiable residual valvular lesions.

Learning Points/Discussion: In case of persistent bacteremia and elevated CRP levels, endocarditis should be considered, even in preterm newborns. Blood cultures should be performed for a prompt initiation of a microbiologically-guided treatment, avoiding selection pressure and emerging of antibacterial resistance. Vancomycin remains the treatment of choice for methicillin-resistant *Staphylococcal* neonatal infections. Daptomycin is a safe and effective option even in case of extremely preterm neonates, to avoid treatment failure in high vancomycin MICs settings. Pharmacokinetic studies are required to establish optimal neonatal doses, and randomized-controlled trials to confirm efficacy and safety.

EP190 / #769

Topic: AS06. Infections in early life / AS06.b. Neonatal sepsis

LATE-ONSET GROUP B STREPTOCOCCUS MENINGITIS POST EARLY ANTIBIOTIC PROPHYLAXIS

E-Posters

E-POSTER VIEWING

Aliyyah Mohammad Khuzaini, Halimah Abdul Halim
Universiti Sains Islam Malaysia, Paediatric Department, Nilai, Malaysia

Title of Case: LATE-ONSET GROUP B STREPTOCOCCUS MENINGITIS POST EARLY ANTIBIOTIC PROPHYLAXIS

Background: Group B Streptococcus (GBS) is a leading infectious cause of neonatal morbidity and mortality. Late-onset GBS infection is defined as GBS infection that occurs after day 7 of life. One of the risk factors for late-onset GBS infection is prematurity. We describe a case of a premature infant who contracted late-onset GBS sepsis and meningitis despite one-week treatment earlier.

Case Presentation Summary: A female baby was born to a primigravida mother at 28 weeks of gestation. The mother presented with leaking liquor more than 48 hours prior to delivery. She received oral erythromycin during the intrapartum period. Her high vaginal swab and placental swab culture grew GBS. Baby was born vigorous; however, she was intubated for respiratory distress. Her blood culture taken after birth was negative and she completed one week of intravenous C-Penicillin. At day 65 of life, the child developed respiratory distress requiring intubation and ventilation. Blood culture grew GBS and lumbar puncture done at day 3 of illness was suggestive for bacterial meningitis.

Learning Points/Discussion: Despite antibiotic completion initially, the patient still developed late-onset GBS infection. This may be acquired from the hospital or even via mother's breastmilk. Although data regarding its incidence have grown in the past few years, research into the risk factors and preventive measures is still scarce. This must be explored further in order to prevent morbidity and mortality from late-onset GBS sepsis.

EP191 / #334

Topic: AS06. Infections in early life / AS06.b. Neonatal sepsis

NEONATAL ELBOW SEPTIC ARTHRITIS WITH SEPSIS AS A COMPLICATION OF VASCULAR PUNCTURE

E-Posters

E-POSTER VIEWING

Joana Pereira-Nunes^{1,2,3}, Débora Silva¹, Gustavo Rocha², Joana Freitas⁴, Henrique Soares^{2,3}

¹Centro Hospitalar Universitário de São João, Department Of Pediatrics, Porto, Portugal, ²Centro Hospitalar Universitário de São João, Department Of Neonatology, Porto, Portugal, ³Faculty of Medicine of Porto University, Department Of Gynecology-obstetrics And Pediatrics, Porto, Portugal, ⁴Centro Hospitalar Universitário de São João, Department Of Orthopaedics And Traumatology, Porto, Portugal

Title of Case: NEONATAL ELBOW SEPTIC ARTHRITIS WITH SEPSIS AS A COMPLICATION OF VASCULAR PUNCTURE

Background: Neonatal septic arthritis' diagnosis, namely of the elbow, requires a high degree of suspicion. The presentation is usually nonspecific and this location is rare. It can lead to serious complications and may progress to sepsis. Group B Streptococcus, gram negative bacilli and Staphylococcus aureus are the most frequent agents.

Case Presentation Summary: An 11 day-old male was transferred to our institution for a Pediatric Cardiology evaluation after a supraventricular tachycardia episode. He had a peripheral venous catheter (PVC) in the left cubital fossa, which was placed for adenosine administration. On D4 after admission, he started fever, irritability, inflammatory signs and pseudoparalysis of the left upper limb, presenting limited mobility and pain during its palpation. Due to PVC's involvement suspicion, it was removed and pus coming out from the orifice was noted. The hypothesis of a septic arthritis was considered and intravenous cefotaxime/vancomycin/gentamicin were empirically initiated. The ultrasound revealed a thin articular effusion. After blood and pus culture isolation of a methicillin susceptible Staphylococcus aureus, antibiotics were adjusted for intravenous monotherapy flucloxacillin. He evolved with clinical improvement, but with the maintenance of some articular rigidity. On D6 of flucloxacillin, an elbow MRI was performed. It ruled out a concomitant osteomyelitis, revealing a massive joint effusion and synovial thickening, compatible with an elbow septic arthritis.



Learning Points/Discussion: This case reports an elbow septic arthritis with sepsis as a complication after a PVC placement. It recalls that, despite being a frequent procedure, even in an urgent/emerging scenario, it can lead to potentially devastating infectious complications, that may require invasive and prolonged treatment. It also highlights the importance of proper compliance to asepsis measures in any procedure.

AN EVALUATION OF EARLY-ONSET NEONATAL SEPSIS GUIDELINES: THE IMPACT OF CHANGED RISK FACTORS

E-Posters
E-POSTER VIEWING

Ellen Van Rossem¹, Frans Plötz^{2,3}, Mariet Felderhof¹

¹Flevo Hospital, Paediatrics, Almere, Netherlands, ²Emma Children's Hospital, Amsterdam University Medical Centre, Paediatrics, Amsterdam, Netherlands, ³Tergooi Hospital, Paediatrics, Blaricum, Netherlands

Backgrounds: The practice of preventing, recognizing and treating early-onset sepsis (EOS) remains a continuous cause of debate. In 2017 a new Dutch neonatal EOS guideline was implemented, adapted from the United Kingdom National Institute for Health and Care Excellence (NICE). The aim of this study is to assess how the change in risk factors impacted the number of neonates that received antibiotic treatment.

Methods:: We performed a single center retrospective cohort study in a relatively large Dutch hospital (Flevo Hospital, Almere). Data were collected from the years 2015, to evaluate the old guideline, and 2019, to evaluate the new guideline. We included 720 neonates that either received treatment for a suspected EOS or were observed for an elevated EOS risk.

Results: The change in risk factors in 2019 led to significantly less antibiotic treatment of the neonate in case of a maternal fever during birth (42/93, 48.4% in 2015 and 31/119, 26.1% in 2019, $p < .001$). The change in definition of prematurity did not lead to a significant change in antibiotic treatment of the neonate (27/93, 29.0% in 2015 and 43/119, 36.1% in 2019 ($p = .477$)). However, in 2019 more neonates between 35-37 weeks gestational age (GA) received antibiotic treatment in comparison to neonates below 35 weeks GA (9/27, 33.3% in 2015 and 24/43, 55.8% in 2019, $p = .053$).

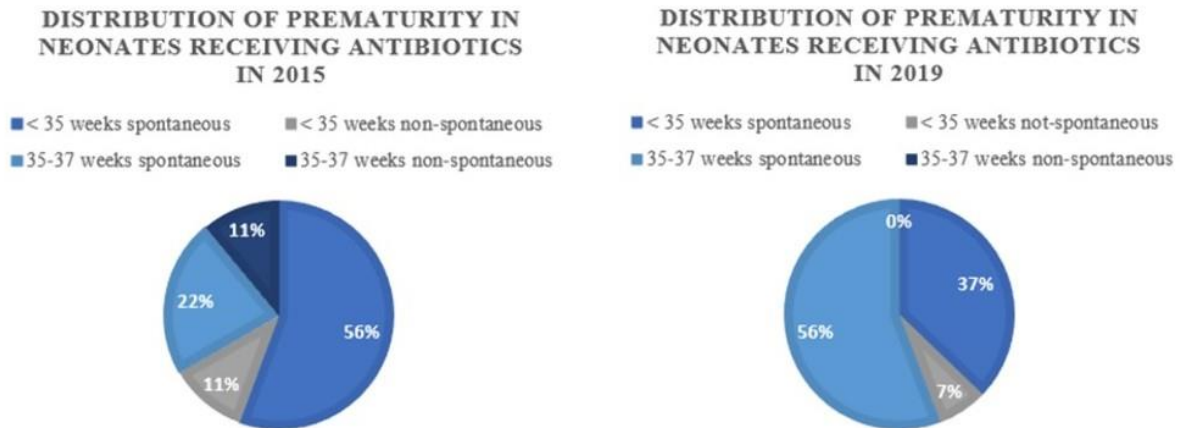

Conclusions/Learning Points: While the new guideline has led to less antibiotic treatment in case of maternal fever, it does not accurately identify the pre-term neonates at risk for EOS. The new guideline weighs all pre-term neonates the same way, whereas it is known that the risk of EOS increases when a neonate is born more premature.

EP193 / #1567

Topic: AS06. Infections in early life / AS06.b. Neonatal sepsis

PHENOTYPE OF ECO-DEPENDENT SEPSIS IN NEWBORNS

E-Posters

E-POSTER VIEWING

Olena Vlasova

Bukovinian State Medical University, Department Of Pediatrics And Pediatric Infectious Diseases, Chernivtsi, Ukraine

Backgrounds: To use cluster analysis to determine the phenotype of ecologically dependent sepsis in newborns in order to improve diagnosis and further treatment.

Methods: We examined 260 newborns with neonatal sepsis. The assessment of the ecological situation in the places of permanent residence of the parents of newborns, which was determined by the value of the ecological risk coefficient (ERC), served as a group-forming feature. The main clinical group was formed by 141 newborns, whose parents permanently resided in areas with $ERC \geq 2.0$. The second group included 119 neonatal patients with sepsis, whose parents lived in areas with $ERC < 2.0$. The main clinical characteristics (gender, gestational age) were comparable to the clinical comparison groups.

Results: The use of cluster analysis made it possible to identify two clusters of neonatal sepsis. The first cluster was made up of newborns whose parents lived in places with an unfavorable ecological situation, and the second cluster was formed by children whose parents lived in conditions with a favorable ecological characteristic. It was noted that the first cluster, in contrast to the second, is characterized by the frequent presence of risk factors for the development of early and late neonatal sepsis ($P < 0.05$), low scores according to the Apgar system ($P < 0.05$), higher scores according to the Dovnes system ($P < 0.05$) at birth, decrease in systolic and mean arterial pressure ($P < 0.01$), expressive severity of the disease with signs of metabolic acidosis and high markers of systemic inflammatory response ($P < 0.05$).

Conclusions/Learning Points: This characteristic of cluster analysis suggests the presence of two phenotypes of neonatal sepsis, which are based on the ecological characteristics of the places of residence of parents of sick children.

EP194 / #1581

Topic: AS06. Infections in early life / AS06.b. Neonatal sepsis

STUDY OF BUCCAL EPITHELIUM IN CHILDREN WITH NEONATAL SEPSIS

E-Posters

E-POSTER VIEWING

Olena Vlasova¹, Kateryna Vlasova²

¹Bukovinian State Medical University, Department Of Pediatrics And Pediatric Infectious Diseases, Chernivtsi, Ukraine, ²Bukovinian State Medical University, Medical Biology And Genetics, Chernivtsi, Ukraine

Backgrounds: The use of non-invasive techniques, such as micronucleus testing, can be used for screening and further prevention of the disease, and does not require significant costs.

Methods: 260 newborns who suffered from neonatal sepsis in 2016-2018 were examined. As a group-forming feature of a comprehensive assessment of long-term exposure of parents of newborns to anthropogenic pollution of air, water and soil, we proposed, based on environmental assessment, the environmental risk factor for the main group was ≥ 2.0 , indicating an unfavorable environmental situation. the second group (comparison) did not reach the value of 2.0.

Results: It should be noted that in the main group the share of children at high risk of cytogenetic disorders with a slight reduction in the quota of low-risk patients probably prevailed. Thus, in group I with low risk of cytogenetic disorders there were 16 children (42.1%), with medium risk - 2 children (5.3%), and with high risk - 20 patients (52.7%). In the comparison group, according to the low risk of cytogenetic disorders, there were 18 children (54.5%, $P > 0.05$), with a medium risk - 4 patients (12.1%, $P > 0.05$), and with a high risk - 11 newborns (33.3%, $P = 0.05$).

Conclusions/Learning Points: Thus, the results of the micronucleus test of exfoliative buccal epithelium allow us to note that in newborns of the main group compared to children in the comparison group significantly more often detected cytogenetic disorders and in some cases disorders of cell kinetics in the form of proliferation and apoptosis. The index of accumulation of cytogenetic disorders was also significantly higher in patients of the main group due to the predominance of patients at high risk of cytogenetic disorders.

EP195 / #1096

Topic: AS06. Infections in early life / AS06.b. Neonatal sepsis

THE EPIDEMIOLOGY OF NEONATAL SEPSIS IN MALTA

E-Posters

E-POSTER VIEWING

Gerd Xuereb, David Pace

Mater Dei Hospital, Department Of Child & Adolescent Health, MSIDA, Malta

Backgrounds: Neonatal sepsis is associated with significant morbidity and mortality. We aimed to study the epidemiology of early and late-onset neonatal sepsis in Malta.

Methods: The study retrospectively evaluated all positive neonatal blood cultures from January 2009 to December 2020 at Mater Dei Hospital, Malta. Contaminants were excluded. Coagulase-negative staphylococci (CONS) were considered significant in neonates with central lines. The incidence of overall and organism specific early-onset sepsis (EOS, <72hours) and late-onset sepsis (LOS, 72 hours-28 days) were calculated.

Results: Over the study period there were 183 episodes of bacterial and 1 episode of fungal neonatal sepsis. The incidence of Gram-positive and Gram-negative bacteraemia was 1.82 and 1.13 per 1000 live-births, respectively. The incidence of EOS remained stable at 1.00 -1.14 per 1000 live-births from 2009-2014 to 2015-2020. Group B streptococcus (GBS) was the most common causative organism, with an incidence of 0.73 (2009-2014) and 0.48 (2015-2020) per 1000 live-births followed by Enterococcus sp. (0.17/1000 live-births), Staphylococcus aureus (0.08/1000 live-births) and Escherichia coli (0.08/1000 live-births). The incidence of LOS increased from 1.91 per 1000 live-births (2009-2014) to 2.98 per 1000 live-births (2015-2020). GBS (0.37/1000 live-births), Escherichia coli (0.23/1000 live-births), and Staphylococcus aureus (0.21/1000 live-births) were the most frequently isolated pathogens. In patients with central lines, CONS were a major contributor of LOS (0.82/1000 live-births).

Conclusions/Learning Points: GBS is the most common cause of EOS in Malta. A culture-based, rather than a risk-based, screening approach for this organism during pregnancy would be expected to decrease the incidence of invasive GBS disease in Malta.

EP196 / #1292

Topic: AS07. Non-respiratory infections / AS07.a. Gastrointestinal infections - Hepatitis

CLINICAL MANIFESTATION AND EPIDEMIOLOGICAL FINDINGS OF CHILDREN PENTASTOMIASIS IN ASIA: A SYSTEMATIC REVIEW

E-Posters

E-POSTER VIEWING

Reza Ghasemikhah^{1,2}, Kourosh Bakhtiari³, Mehrdad Nahvi⁴

¹Arak University of Medical Sciences, Department Of Parasitology And Mycology, School Of Medicine, Arak, Iran, ²Arak University of Medical Sciences, Infectious Diseases Research Center (idrc), Arak, Iran, ³Arak university of medical sciences, Students Research Committee, Arak, Iran, ⁴Arak University of Medical Sciences, Medical Diagnosis Laboratory Of Vali Asr Hospital, Arak, Iran

Backgrounds: Pentastomiasis is a parasitic zoonosis caused by pentastomids. Infection in humans occurs accidentally by eating the infected eggs or nymphs. The severity of clinical symptoms depends on the infected organs, degree of infection, and migration of the parasite. The aim of this study is clinical manifestation and epidemiological findings of children pentastomiasis in Asia.

Methods: This systematic review follows the guidelines of PRISMA. the keywords were searched on the online databases of PubMed, Scopus, ScienceDirect and Google Scholar on December 27, 2021. All human case report articles, in Asia, in English language, that had full text and sufficient information were reviewed.

Results: 9 articles (15 cases) for children under 18 were included in this study. The reported cases were from 4 different Asian countries: China (73%), Iran (13%), India (7%) and Israel (7%). 11 number of the cases including all of the China cases, were visceral. 2 cases of Iran were nasopharyngeal and both of the India and Israel cases were found in the eye. In the visceral type, liver, small intestine, lungs, and lymph nodes were most involved. Abdominal pain, chronic fever, diarrhea and ascites were common clinical symptoms in this type.

Conclusions/Learning Points: Visceral pentastomiasis should be considered in the diagnosis of patients with clinical symptoms of abdominal pain, fever, diarrhea, and ascites with a history of eating raw snake meat or viscera. Also, nasopharyngeal pentastomiasis should be considered in the diagnosis of patients with clinical signs of sneezing, coughing, respiratory discomforts and nasal discharge with a history of eating raw meat or viscera of infected herbivorous mammals. Health education and strict control of livestock slaughter in slaughterhouses is also recommended.

ROTA VIRUS ACUTE GASTROENTERITIS (RVAG) BEFORE AND DURING THE COVID-19 PANDEMIC

E-Posters

E-POSTER VIEWING

Catarina Dias¹, Margarida Sampaio¹, Alexandra Canha², Dina Domingues², Lurdes Correia³, Fernanda Rodrigues^{1,4}

¹Hospital Pediátrico, Centro Hospitalar e Universitário de Coimbra, Portugal, 1. infectious Diseases Unit And Emergency Service, Coimbra, Portugal, ²Centro Hospitalar e Universitário de Coimbra, Portugal, Clinical Pathology Service., Coimbra, Portugal, ³Centro Hospitalar e Universitário de Coimbra, Clinical Pathology Service, Coimbra, Portugal, ⁴University of Coimbra, Faculty Of Medicine, Coimbra, Portugal

Backgrounds: In Portugal, RV remains an important cause of acute gastroenteritis (AG). Two RV vaccines have been used on the private market since 2006, with estimated coverage ~60%. A high effectiveness to prevent admissions and observation in the emergency service (ES) was shown in a case-control study. The implementation of non-pharmacological interventions during the COVID-19 pandemic had a dramatic impact on other respiratory infections, with important reductions or disappearance followed by resurgence with big epidemics outside the usual seasonality. The aim of this study is to describe the impact of the COVID-19 pandemic on annual RV epidemics.

Methods: Retrospective analysis of all AG episodes (≥ 3 stools/24h) in children aged ≤ 36 months, observed in the ES between Jan 2012 and Dec 2021 (n=16508). Stool samples were tested for RV using a rapid immunochromatographic test. Around 30% of the children with AG were tested for RV each year, with a decrease in 2021 (19%).

Results: The number and percentage of cases of AG observed and tested for RV over the last decade is shown in the figure. In 2020 there was a significant drop in the number of AG and RVAG observed in the ES and no annual epidemic. In 2021, although the number of AG has returned to pre-COVID values, RVAG cases decreased to historic low levels. The average age of RVAG cases remained stable (~16 months).

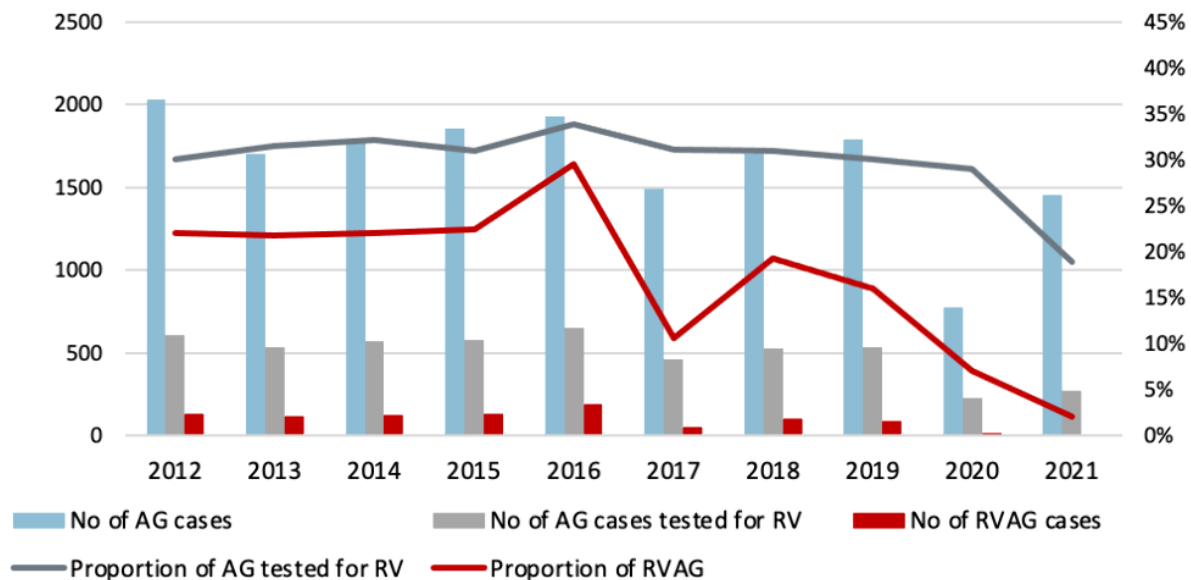

Conclusions/Learning Points: After 2016, there was a downward trend in the RVAG observed in the

ES, accelerated during the COVID-19 pandemic, with no annual epidemic and historic low levels of RVAG despite the increase in AG cases in 2021.

EP198 / #1615

Topic: AS07. Non-respiratory infections / AS07.a. Gastrointestinal infections - Hepatitis

THE EFFECT OF BALSAMIC VINEGAR AND APPLE CIDER VINEGAR ON GIARDIA PARASITE CYSTS IN VITRO

E-Posters

E-POSTER VIEWING

Reza Ghasemikhah^{1,2}, Mehrdad Nahvi³

¹Arak University of Medical Sciences, Infectious Diseases Research Center (idrc), Arak, Iran, ²Arak University of Medical Sciences, Parasitology And Mycology, Arak, Iran, ³Arak university of medical sciences, Medical Diagnosis Laboratory Of Vali Asr Hospital., Arak, Iran

Backgrounds: Giardiasis is a parasitic infection of the small intestine with worldwide spread. The prevalence of Giardia lamblia in different parts of the world varies between 1 and 25% of the population. Vinegar has a wide range of antimicrobial and antifungal activities for alternative therapies for microbial and parasitic pathogens such as Giardia. In this study, the effect of vinegar on Giardia lamblia cyst was investigated in vitro.

Methods: Giardia cyst was extracted from feces using modified Bingham method and then exposed to apple cider vinegar and balsamic vinegar for 10, 20, 30 and 60 minutes. After this step, Giardia cysts were washed with physiological serum and then the mortality of the cysts was examined under a microscope using 0.1% eosin staining and neobar slide. Negative control group was used at laboratory temperature along with each reaction of apple cider vinegar and balsamic vinegar. The positive control group was also used at laboratory temperature with each reaction of apple cider vinegar and balsamic vinegar.

Results: Giardia cyst had 89.9% mortality in the presence of apple cider vinegar at a concentration of 100% after 60 minutes and 62% mortality in the presence of balsamic vinegar at a concentration of 100% after 60 minutes. The highest mortality of Giardia cysts (89.9%) was observed in the presence of apple cider vinegar.

Conclusions/Learning Points: Laboratory and clinical studies show that the drug resistance of Giardia lamblia in different parts of the world to metronidazole, quinacrine and paromomycin in patients is increasing and chemical drugs have many side effects.

Due to the fact that vinegar has anti-parasitic properties in laboratory conditions. It can be hoped that vinegar will be a viable alternative to chemical antiparasitic drugs in the future.

EP199 / #1385

Topic: AS07. Non-respiratory infections / AS07.a. Gastrointestinal infections - Hepatitis

A RARE PRESENTATION OF COMMON HELMINTHIASIS

E-Posters

E-POSTER VIEWING

Araqsya Baghdasaryan¹, Aida Papikyan¹, [Hrachuhi Ghazaryan](#)^{1,2}

¹Wigmore clinic, Pediatric, Yerevan, Armenia, ²Yerevan State Medical University after M. Heratsi, General Pediatric #1, Yerevan, Armenia

Title of Case: A rare presentation of common helminthiasis

Background: *Ascaris lumbricoides* is one of the commonest human parasitic infections worldwide.

Although the adult ascaris normally resides in the small intestine, it can migrate to lungs, urinary bladder, peritoneum and biliary system. Biliary ascariasis is reported from highly endemic regions. Our aim is to report a case of hepatobiliary ascariasis misdiagnosed as Alveolar hydatid disease.

Case Presentation Summary: A 9-year-old previously healthy girl was referred to our clinic due to persistent eosinophilia (absolute eosinophil count[AEC] 15000/ul). She was examined by a hematologist; hematological malignancy was excluded by bone marrow examination. The girl had no complaints and the general examination was normal. Repeated blood count showed AEC 17000-11210/ul, no anemia. Liver functional tests were in the normal range. The ultrasound of the abdomen revealed heterogenous echotexture lesions of 2 cm diameter in the right lobe of the liver, enlarged periportal lymph node up to 1.5 cm. Stool microscopy was positive for fertilized eggs of *Ascaris lumbricoides*. The girl received Mebendazole 200 mg BID for 3 days. On follow up eosinophils decreased to 2250. As she started to complain of abdominal pain and still had persistent eosinophilia, MRI of abdomen was performed. The report was inconclusive; liver damage was more suggestive of Alveolar Echinococcosis. The concilium with surgeons decided to start Albendazole 15 mg/kg/day for 28 days. Follow up ultrasound was planned for further surgical management of Alveolar Echinococcosis. Ultrasound showed normal liver parenchyma but the presence of a long, straight, tubular, non-shadowing, echogenic structure in the gallbladder, indicative of *Ascaris lumbricoides*.

Learning Points/Discussion: In developing countries where incidence of helminthiasis is high, in the deferential diagnosis of eosinophilia pediatricians should include extensive work-up for parasitic infestations.

Topic: AS07. Non-respiratory infections / AS07.a. Gastrointestinal infections - Hepatitis

SEROPREVALENCE OF ANTIBODIES AGAINST HEPATITIS E VIRUS AND PARVOVIRUS B19 AMONG HEMATOLOGY PEDIATRIC PATIENTS

E-Posters

E-POSTER VIEWING

Chiydem Ismailova¹, Radostina Stefanova¹, Tencho Tenev¹, Polina Miteva², Stefka Krumova¹, Elitsa Golkocheva-Markova¹

¹NCIPD, Virology, Sofia, Bulgaria, ²Specialized Hospital for Active Treatment of Children's Diseases „Prof. Dr. Ivan Mitev“ EAD,, Hematology, Sofia, Bulgaria

Backgrounds: Hepatitis E (HEV) is a single stranded RNA virus. Usually the infection is asymptomatic. In Europe the most common transmission pathways are food chain and unscreened blood and blood products. Other viruses transmitted by blood are HBV, HCV, HIV, HTLV-1, CMV, parvovirus B19 (B19V), etc. Infection with Parvovirus B19 is typical for childhood. So far, data on HEV and parvovirus B19 seroprevalence in pediatric hematology patients are limited. The aim of the present study is to evaluate the HEV and B19 prevalence in hematology pediatric patients.

Methods: In this retrospective study, serum samples from 16 hematological pediatric patients were tested for antibodies against Hepatitis E virus and Parvovirus B19 by ELISA. The median age was 8.0 ± 7.1 years (min 0.1 and max 17), as 37% were male and 63% female.

Results: From all tested samples 11 (69%) were positive for HEV Ab, 10 (63%) – for B19V Ab, and 6 (38%) – for both viruses. Positive for IgM class antibodies were 9 (82%) against HEV, 8 (80%) – against B19V, and 6 (100%) – against both viruses. The IgG seropositivity was: 5 (45%) – HEV, 5 (50%) – B19V, and 2 (33%) – against both viruses. The children between 0 and 5 years were with the highest prevalence of antibodies against the both viruses – 8 (50%) for HEV, and 6 (37%) – for B19V. From HEV Ab positive samples 8 (73%) were with anaemia and 3 (27%) – with cytopenia, respectively from B19V Ab positive and from seropositive samples for both viruses 5 (45%) and 3 (27%).

Conclusions/Learning Points: Transfusion in children is associated with increased seroprevalence for HEV and parvovirus B19.

EP201 / #1033

Topic: AS07. Non-respiratory infections / AS07.a. Gastrointestinal infections - Hepatitis

EVALUATION OF CHILDREN PRESENTED WITH DIARRHEA IN WHOM GASTROINTESTINAL PATHOGEN WAS DETECTED BY MULTIPLEX PCR

E-Posters

E-POSTER VIEWING

Yalçın Kara¹, Mahmut Kizil¹, Ömer Kılıç¹, Tercan Us², Ener Dinleyici³

¹Eskişehir Osmangazi University, Pediatric Infectious, Eskişehir, Turkey, ²Eskişehir Osmangazi University, Microbiology, Eskişehir, Turkey, ³Eskişehir Osmangazi University, Pediatric Intensive Care, Eskişehir, Turkey

Backgrounds: Acute gastroenteritis is one of the most common causes of hospital admission in children. Treatment regimens differ depending on the pathogen. In our study, we aimed to evaluate the epidemiological and clinical features of pediatric patients whose gastrointestinal pathogen were detected by Multiplex PCR.

Methods: The study included 131 pediatric patients who were followed up at Eskişehir Osmangazi University, Pediatric Department between January 2018 and December 2021. Gastrointestinal pathogens were detected in stool samples by Multiplex PCR. The epidemiological and clinical features were reviewed retrospectively.

Results: A total of 202 gastrointestinal pathogens were detected from the stool samples of 131 cases. 56% of the cases were male and mean age was 66 months. The most common symptoms were diarrhea, fever, vomiting. A single pathogen was detected in 85 cases and multiple pathogens were detected in 46 cases. The most common pathogens were EPEC, Clostridium difficile, Norovirus, Rotavirus, Salmonella, ETEC and Campylobacter jejuni. Stool culture was positive in 12% cases and microscopic examination positive in 13% cases. Probiotic treatment was given to 92% cases, and antimicrobial treatment (metronidazole, ceftriaxone, azithromycin, oral vancomycin) to 26% cases. 42% of cases had chronic disease, 30% had a history of previous antibiotic use, and 13% had a history of hospitalization. Antibiotic use and detection of multiple factors was higher in patients with a history of chronic disease, patients who used antibiotics before, and patients who were hospitalized in intensive care units ($p < 0.05$).

Conclusions/Learning Points: In the detection of gastrointestinal pathogens, the sensitivity of Multiplex PCR is higher than stool culture, direct microscopic examination and antigen tests. However, clinical findings, other microbiological tests and risk factors should be considered in the evaluation of the pathogenicity and treatment.

EP202 / #1225

Topic: AS07. Non-respiratory infections / AS07.a. Gastrointestinal infections - Hepatitis

CAMPYLOBACTER JEJUNII INCIDENCE & ANTIBIOTIC SUSCEPTIBILITY: A RARE CAUSE OF BACTEREMIA IN CHILDREN.

E-Posters

E-POSTER VIEWING

Maria Daskalaki¹, Patra Koletsi², Maria Syrrou¹, Eleni Galani², Panagiota Xirokosta¹, Evangelia Mavrantoni², Stavroula Kostaridou², Efstathia Staikou¹

¹Penteli Children's Hospital, Biopathology Department, Athens, Greece, ²Penteli Children's Hospital, Paediatrics, Athens, Greece

Backgrounds: According to ECDC, Campylobacteriosis is the most commonly reported gastrointestinal disease in the EU/EEA, however, it is rarely implicated in invasive disease. Blood stream infections caused by Campylobacter spp. have been particularly reported in patients with immune deficiency and malnutrition among other serious underlying conditions. We conducted a retrospective study to explore the incidence of Campylobacter jejuni diarrhea and its involvement in bacteremia.

Methods: Blood and stool cultures were tested in the Microbiology Laboratory of a Tertiary Paediatric Hospital between 01/01/2020 and 31/12/2021. Clinical and microbiological data were collected. Bacteria were identified as Campylobacter spp based on colony morphology, Gram stain and routine biochemical methods.

Results: During the study period 1152 stool cultures were tested from 705 pediatric patients. Campylobacter spp was isolated from 43 patients (6.1%) aged 2 months to 15 years, collected from 73 stool cultures. Forty-one (95.3%) isolates were identified as Campylobacter jejunii. Erythromycin resistance was observed in only one isolate (2.3%). Resistance to ciprofloxacin and tetracycline was 86% and 69.7% respectively. Blood cultures were obtained from 32 of 43 patients infected with Campylobacter spp (74.4%). Of these, only one had Campylobacter jejunii bacteremia (2.5%). The unique case of bacteremia referred to a previously healthy, well-nourished, 10-year-old female. They presented with high temperature and abdominal pain which preceded diarrhea. A blood culture taken on the day of admission and the subsequent stool culture both grew Campylobacter jejunii. The patient was treated with 5 days oral azithromycin and had an uneventful recovery.

Conclusions/Learning Points: In our series campylobacteriosis incidence remains relatively low. However, Campylobacter jejunii bacteremia may still be observed despite the absence of dysentery as a presenting sign. Macrolides remain the treatment of choice, nevertheless, continued surveillance is advised.

EP203 / #1295

Topic: AS07. Non-respiratory infections / AS07.a. Gastrointestinal infections - Hepatitis

PEDIATRICS WITH ENTEROBIUS VERMICULARIS INFECTION IN THE EYE: A GLOBAL SYSTEMATIC REVIEW

E-Posters

E-POSTER VIEWING

Javad Mahdavi¹, Reza Ghasemikhah^{2,3}

¹Arak University of Medical Sciences, Students Research Committee, Arak, Iran, ²Arak University of Medical Sciences, Infectious Diseases Research Center (idrc), Arak, Iran, ³Arak University of Medical Sciences, Department Of Parasitology And Mycology, School Of Medicine, Arak, Iran

Backgrounds: Enterobius vermicularis, often referred to as pinworm, is an intestinal nematode which commonly infects pediatrics throughout the world. The presence of the worm outside the intestine, especially in the eye, is rare. The aim of this study was to assess the clinical and paraclinical findings in pediatrics with E. vermicularis infection in the eye.

Methods: A systematic search was conducted on MEDLINE/PubMed, Web of Science, Scopus, ScienceDirect, and Google Scholar from inception to 2021 following the PRISMA guidelines. Study selection and data extraction were performed by two independent researchers.

Results: A total of 7 studies met the inclusion criteria. Among the cases, 6 were female and 1 was male with an age range of 2.5 to 15 years. The most prevalent symptoms were complaints of wriggling worms coming out from the eye, photophobia, eye redness, and eye itching. Eye examination revealed: Normal vision (5 cases), discharging slight sero-purulent from eye (4 cases), Oculospordial polyp infected (1 case), and posterior synechiae with cataractous lens (1 case). The conjunctival sac, the upper fornix and the anterior chamber of the eye were the sites revealed the presence of the worms and the highest total number of worms expelled in one patient was 42. Ova of E. vermicularis in stool and eosinophilia were reported in 2 and 1 cases, respectively. Also, conjunctival swab culture showed growth of Staphylococcus albus in 1 case.

Conclusions/Learning Points: E. vermicularis infection in the pediatric eye has moderate to severe complications and can diminish their work capacity. Therefore, it is necessary to reduce the prevalence of the parasite with proper education and health promotion, especially in kindergartens and schools, and to prevent its complications by timely diagnostic measures and appropriate treatment.

EP204 / #714

Topic: AS07. Non-respiratory infections / AS07.a. Gastrointestinal infections - Hepatitis

CLOSTRIDIODES DIFFICILE INFECTION IN JAPANESE CHILDREN

E-Posters

E-POSTER VIEWING

Atsushi Miyake^{1,2}, Saho Shima¹, Yuhei Tanaka¹, Kenji Gotoh^{1,2}, Hiroshi Watanabe²

¹Kurume university school of medicine, Pediatrics And Child Health, Kurume city, Fukuoka, Japan, ²Kurume University School of Medicine, Infection Control And Prevention, Kurume, Japan

Backgrounds: Clostridioides difficile (CD) is one of the organisms that the cause of diarrhea following antibiotic administration. Although it is known that there are many cases of carriage in infants, there is no consensus on pathogenicity in children. We retrospectively examine the cases treated as CD infection (CDI) in a pediatric ward and clarify the current status of CDI in children.

Methods: The subjects are patients who have been hospitalized in the Kurume University Hospital between April 1, 2014, and October 1, 2021, of which 45 were positive out of 184 patients submitted for CD antigen test on stool. In these 45 cases, we retrospectively examined the age, gender, underlying disease, symptoms, pre-administration of antibiotics, therapeutic drugs for CDI, and recurrence.

Results: The median age was 4 years (5 months-13 years) and 22 boys. 14 CD toxin positive cases were observed (4 positive cases were nucleic acid amplification test). The main underlying disease was blood tumor disease in 28 cases, circulatory disease in 8 cases, neurological disease in 5 cases. Pre-administration of antimicrobial drugs were observed in 54 patients. The symptoms were fever in 26 patients, diarrhea in 28 patients, and bloody stool in 6 patients. Treatment were VCM in 41 cases, MNZ in 2 cases, only antimicrobial drug discontinuation in 2 cases. Recurrence was observed in 11 cases (24.4%), and the number of recurrences was 6 times at most.

Conclusions/Learning Points: In this study, we revealed that CDI cases requiring treatment were present in children with underlying diseases, and the recurrence rate was similar to that in adults. Multiple recurrent cases of CD infection have been observed, and it is necessary to prepare treatment guidelines for recurrent cases in children.

EP205 / #1459

Topic: AS07. Non-respiratory infections / AS07.a. Gastrointestinal infections - Hepatitis

SPLenic INVOLVEMENT RELATED TO SALMONELLA SPECIES INFECTIONS: A CASE SERIES

E-Posters

E-POSTER VIEWING

Costanza Tripiciano¹, Maia De Luca², Giulia Lorenzetti¹, Andrzej Krzysztofiak², Lorenza Romani², Sara Chiurchiù², Martina Di Giuseppe², Francesca Ippolita Calò Carducci², Laura Cursi², Alessandro Jenkner², Laura Lancella²

¹Bambino Gesù Children's Hospital IRCCS, Pediatric Academic Department, University Of Rome Tor Vergata, Roma, Italy, ²Bambino Gesù Children's Hospital, IRCCS, Immunological And Infectious Disease Unit, University Department Of Paediatrics, Roma, Italy

Title of Case: Splenic involvement related to Salmonella species infections: a case series

Background: Salmonella species are usually responsible for gastroenteritis; however, a spectrum of extra-intestinal localizations is described. We reported two cases of healthy children with different splenic involvement related to Salmonella species infections.

Case Presentation Summary: A 17-years-old boy presented to the emergency department due to fever and diarrhea after eating raw eggs. The abdominal ultrasound showed an infarction in the outer portion of the spleen [Figure 1]. The blood and stool cultures revealed a group-C-Salmonella infection and therapy with ceftriaxone was started. Because of the persistent fever, the embolic event, and the Salmonella isolate, an echocardiography was performed, showing a thickening of the aortic right cusp. A diagnosis of "possible" endocarditis was done according to Duke criteria (1 major + 3 minor), thus gentamicin was added to the therapy for two weeks. Overall, the therapy with ceftriaxone was performed for 4 weeks. A 9-years-old girl with fever and abdominal mass was admitted to our department. Laboratory tests showed an increase of C-Reactive Protein, and the abdominal ultrasound described an anechoic structure of 14x12 cm, later confirmed by M.R.I. [Figure 2]. A broad-spectrum antibiotic therapy was started and the diagnosis of Echinococcus infection was excluded. Due to the poor clinical response, the cyst was drained, and the analysis of the fluid revealed a group-D-Salmonella infection. The stool and the blood cultures were negative. Two weeks of therapy with ceftriaxone were performed.



Figure 1

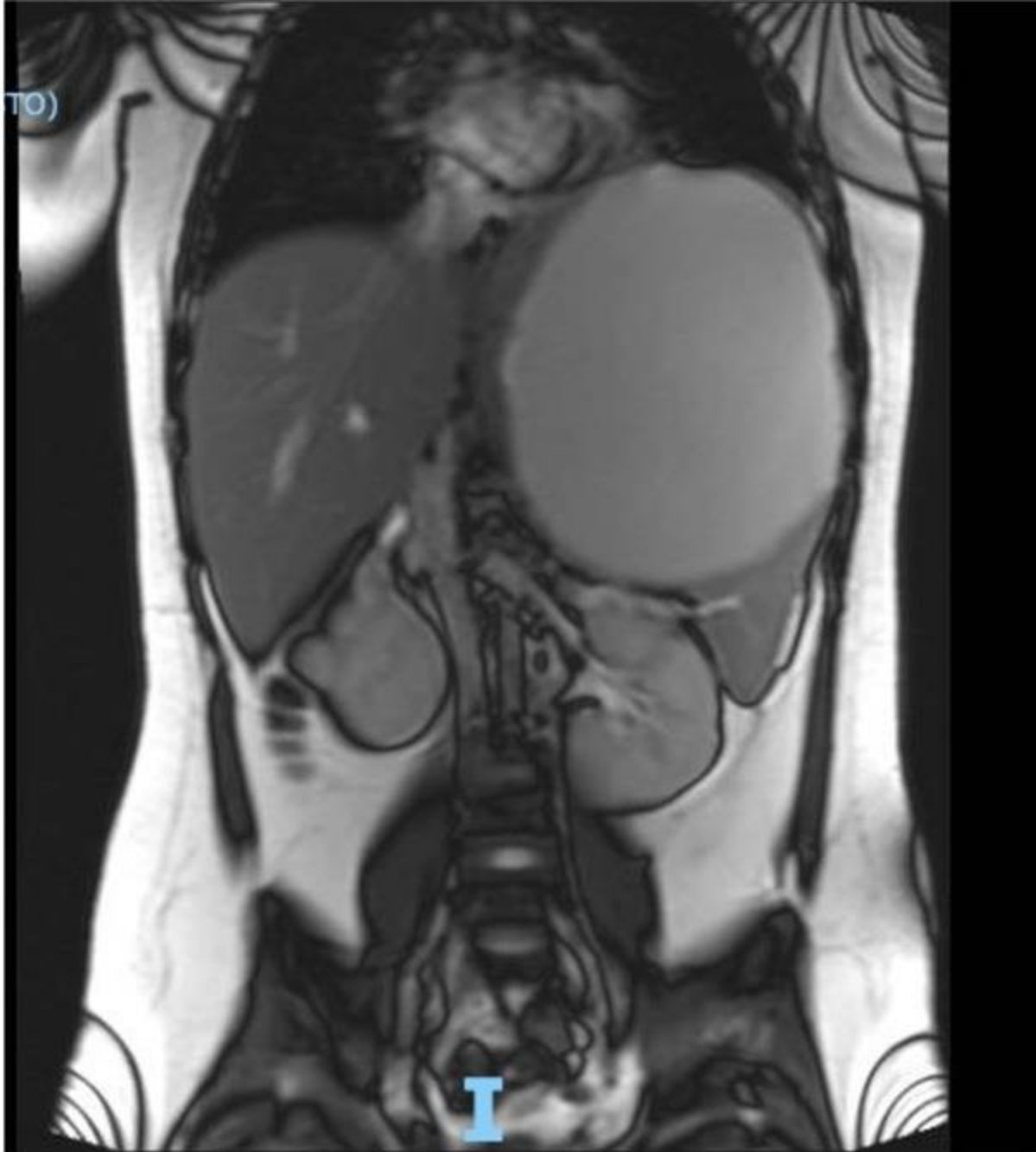

Figure 2

Learning Points/Discussion: Our cases demonstrated that *Salmonella* may cause severe extraintestinal disease, even in immunocompetent patients. For this reason, in patients affected by splenic lesions of unknown origin, with or without a suggestive infectious history, etiological investigations should include serological and microbiological studies for *Salmonella* species.

EP206 / #1903

Topic: AS07. Non-respiratory infections / AS07.a. Gastrointestinal infections - Hepatitis

INFANT WITH MULTIPLE PYOGENIC LIVER ABSCESSSES (PLA)

E-Posters

E-POSTER VIEWING

Anuruddhika Withana, Janath Liyanage, Upeksha Liyanage, Bhagya Piyasiri
Teaching Hospital-Karapitiya, Galle, Paediatrics, Galle, Sri Lanka

Title of Case: INFANT WITH PYOGENIC LIVER ABSCESSSES

Background: Liver abscesses occurs following infectious causes like, Pyogenic, Parasitic, Fungal or noninfectious causes. PLA are uncommon in children. Bacteria invade the liver either through haematogenous, biliary tract, portal vein or direct contiguous infection. Risk is more with malignancies, Chronic Granulomatous Disease (CGD) and Hyper IgE syndrome. Frequency increased in males.

Case Presentation Summary: 5 months baby boy, in orphanage, born to teenage mother, presented with acute respiratory distress, abdominal distention 1 day. Antenatal, Birth histories unavailable. Had PR bleeding at 3/12; Colonoscopy and Biopsy done. Found anal mucosal tissues with mixed inflammation without evidence of malignancy. 2/52 before acute presentation, had Acute Gastroenteritis. Since 1/12 age baby fed with formula. Examination; Had mild pallor, low weight, distended abdomen, tender 4cm hepatomegaly and free fluid (FF) with increased respiratory rate and reduced O₂ saturation. No icterus. Rest of the examinations were normal. Later developed fever. Investigations; CBC; Neutrophil Leukocytosis with low Haemoglobin. Elevated inflammatory markers. Liver functions deranged, except serum bilirubin. Ultrasound Scan Abdomen; Multiple Liver Abscesses in Right lobe with



FF. Due to acute presentation, IV Antibiotics started before intervention. Kept Nil Oral. Maintained fluids and electrolytes. Low Haemoglobin and coagulopathy corrected with blood and FFP. USS guided aspiration done; Full Report showed Field Full pus cells. Cytology, Culture Negative. Amoebiasis, Tuberculosis, Melioidosis, Brucellosis excluded. HIV, VDRL, TPHA, HepatitisB Negative. Immunoglobulin levels, Stool investigations negative. CGD excluded with Nitroblue Tetrazolium test. Later inserted a pigtail drainage due to increased abscess sizes. Managed as PLA, with IV Antibiotics for 6 weeks.

Learning Points/Discussion: Though the PLA are uncommon, it can occur at any age. Available history was favour of Immunodeficiency or Parasitic origin. Investigations were supportive towards PLA. Had to take life saving measures first. Treated the baby as PLA.

EP207 / #1923

Topic: AS07. Non-respiratory infections / AS07.a. Gastrointestinal infections - Hepatitis

SIGNIFICANT GALLBLADDER HYDROPS IN A PATIENT WITH KAWASAKI DISEASE AND ROTAVIRUS INFECTION.

E-Posters

E-POSTER VIEWING

Konstantinos Zachos, Vasiliki Remoundou, Polyzwis Velentzas, Tatiana Alexandrova, Kosmas Kotsonis
AGIA SOPHIA CHILDRENS HOSPITAL, First Pediatric Department, ATHENS, Greece

Title of Case: SIGNIFICANT GALLBLADDER HYDROPS IN A PATIENT WITH KAWASAKI DISEASE AND ROTAVIRUS INFECTION.

Background: Defined as an overdistended gallbladder filled with sterile fluid, gallbladder hydrops is rarely encountered in Pediatrics, classically in the context of Kawasaki disease(KD). Less commonly, it is associated with infections and other immune-mediated pathologies.

Case Presentation Summary: A 5-year-old boy was admitted with fever, rash and abdominal pain with palpable liver. Laboratory workup indicated increased inflammation markers, transaminitis and mild direct hyperbilirubinemia. Initial abdominal ultrasound was without significant pathologies, apart from marginal hepatomegaly and small amount of fluid in hepatorenal space. On fever day 6, our patient met incomplete KD criteria and was treated with IVIG and aspirin, achieving immediate apyrexia and improvement of inflammation markers. Transaminitis and bilirubinemia also subsided. Periungual desquamation was noticed during subacute phase. On day 10, he developed Rotavirus gastroenteritis (positive fecal immunoassay) and after 2 days, severe abdominal pain and vomiting was noted. Physical examination revealed a palpable right abdominal mass. Mainly suspecting intussusception, ultrasound was ordered, demonstrating significant gallbladder hydrops (dimensions: 11.47 x 3.83 cm) and bile sludge. After consulting Rheumatology, Infectious Disease and Gastroenterology specialists, short term steroids, antibiotics, ursodeoxycholic acid and fat-free diet were used. His symptoms rapidly improved, palpable mass resolved, and gallbladder ultrasound normalized in follow-up examinations after 10 and 30 days respectively. His further clinical course is uncomplicated. It is not clear whether our patient's symptomatology is solely attributed to KD, or whether it was triggered by Rotavirus infection, which can per se cause gallbladder hydrops.



Learning Points/Discussion: Manifesting from asymptomatic sonographic gallbladder enlargement to a palpable abdominal mass, gallbladder hydrops is classically described in the acute and subacute phase of KD. Prognosis is favorable and should be mainly differentiated from acute surgical conditions.

EP208 / #971

Topic: AS07. Non-respiratory infections / AS07.b. Urogenital infections

ACUTE GENITAL ULCER (LIPSCHUTZ ULCER) IN 2 ADOLESCENT GIRLS

E-Posters

E-POSTER VIEWING

Chionia Charalampidou¹, Nickolas Lamprinos², Pelagia Neonaki¹, Fani Ladomenou², Olga Grafakou¹, Elisabeth Giannousi¹

¹General Hospital, Pediatrics, Rethymnon, Crete, Greece, ²Venizeleion General Hospital, Pediatrics, Heraklion, Greece

Title of Case: ACUTE GENITAL ULCER (LIPSCHUTZ ULCER) IN 2 ADOLESCENT GIRLS

Background: Acute genital ulcers are a rare entity, predominantly in virgin young girls, that can cause great distress to the patient and the parents.

Case Presentation Summary: We present two cases of acute vulvar ulcers in two sexually inactive adolescents. The first patient is a 13-year-old girl with prodromal systemic symptoms followed a week later by two painful ulcerated genital lesions in a bilateral kissing pattern with dysuria. The second patient is a 12-year-old girl who was referred to the emergency department because of fever and three painful ulcers in the genital area with a six day history of fever and sore throat. Laboratory investigation revealed in both of them elevated inflammatory markers. Serological tests and Polymerase chain reaction for Epstein-Barr virus (EBV), cytomegalovirus (CMV), syphilis and herpes simplex virus (HSV) were negative. The patients were treated with antibiotics and topical wound care with antiseptics. The ulcers in both cases healed within 10 days without leaving scarring.

Learning Points/Discussion: Acute genital ulcers, also known as Lipschütz ulcer is a self-limited, non-sexually transmitted condition characterized by painful necrotic ulceration of the vulva or lower vagina. Immune response to infectious diseases such as EBV, CMV and M. pneumoniae seems to be associated but, in most cases, the association with an infection could not be confirmed. The differential diagnosis is broad, including infectious agents, autoimmune disorders, and trauma. Diagnosis of Lipschütz ulcer is mainly clinical, after exclusion of other causes of vulvar ulcers. Recognition of Lipschütz ulcer is important to the extent that patients receive appropriate treatment and counseling.

EP209 / #49

Topic: AS07. Non-respiratory infections / AS07.b. Urogenital infections

ANTIMICROBIAL RESISTANCE OF URINARY TRACT INFECTION IN CAMBODIAN CHILDREN

E-Posters

E-POSTER VIEWING

Sam Lyvannak

Angkor Hospital for Children, Pediatric, Siem Reap, Cambodia

Backgrounds: Antimicrobial resistance (AMR) is an emerging global public health threat. In Cambodia, community-acquired AMR causes serious bacterial infections in children, due to uncontrolled community antibiotic use. Unlike most Cambodian hospitals, Angkor Hospital for Children has microbiology facilities and is able to design antibiotic guidelines based on local evidence. We aimed to determine the prevalence and type of AMR in bacterial urinary tract infection (UTI) in children presenting to our outpatient department (OPD) over six months.

Methods: A retrospective study was conducted of UTI in children aged 1 month to 16 years presenting to OPD over 6 months in 2016.

Results: 25 of the total 90 cases of UTI were culture positive. The most common organism was *Escherichia coli* (76%) and this demonstrated resistance to all commonly available antibiotics (amoxicillin 100%, cotrimoxazole 77.8%), and 41% were extended-spectrum beta-lactamase species. The most common antibiotics to which these UTI were sensitive nitrofurantoin and imipenem.

Conclusions/Learning Points: AMR is a significant problem affecting common pediatric serious bacterial infections. The majority of UTI are culture-negative due to prior antibiotic use and the majority of culture-positive UTI are not susceptible to commonly available antibiotics.

EP210 / #1469

Topic: AS07. Non-respiratory infections / AS07.b. Urogenital infections

URINARY TRACT INFECTIONS AND KIDNEY STONES ASSOCIATION IN CRETAN PEDIATRIC POPULATION

E-Posters

E-POSTER VIEWING

Kalliopi Vardaki, Maria Bitsori, Emmanouil Galanakis
University Hospital of Heraklion, Paediatrics, Heraklion, Greece

Backgrounds: Urinary tract infection (UTI) is frequently reported in children with kidney stones. UTI may either complicate pre-existing lithiasis or be directly responsible for stone formation (infection stones). Genitourinary abnormalities additionally predispose to stone formation by promoting stasis of urine and infection. The aim of this study was to investigate UTIs and lithiasis comorbidity in our region.

Methods: All infants and children up to 16 years old diagnosed with lithiasis/nephrocalcinosis from 2007 to 2021 were retrospectively included in the study. Demographic characteristics, incidence of UTI, co-existence of genitourinary abnormalities and recurrence of lithiasis were recorded.

Results: A total of 73 children with lithiasis/nephrocalcinosis were retrieved. Twenty six (35.6%), 15 boys and 11 girls with a median age of 4.67 years were found with UTI comorbidity and in 14 of them (53.8%) UTI was the initial manifestation of lithiasis. In these 14 patients although *E. coli* was the commonest pathogen (6/14) non-*E. coli* organisms prevailed (*P. mirabilis*, 5, *E. faecalis*, 2 and *E. cloacae*, 1). A significant proportion (43.4%) belonged to immigrant population minorities with limited accessibility to healthcare services and nine of them (34.6%) had a positive family history for lithiasis. Six children (23%) were diagnosed with major genitourinary abnormalities (ureteropelvic junction obstruction, neurogenic bladder, solitary kidney, vesicoureteral reflux, posterior urethral valves) and five (19.2%) were readmitted with recurrent, non-infectious lithiasis.

Conclusions/Learning Points: Urolithiasis and UTI comorbidity is not unusual among infants and children in our region and is mostly associated with the genetic and social background of the population as well as genitourinary abnormalities. Nevertheless, UTIs concomitant of lithiasis do not tend to recur. Thorough metabolic investigation and detailed information of previous history will contribute to our further understanding of the lithiasis/UTI association.

EP211 / #1891

Topic: AS07. Non-respiratory infections / AS07.b. Urogenital infections

HAEMOPHILUS PARAINFLUENZA URINARY TRACT INFECTION UNMASKING UNDERLYING ANATOMIC ANOMALY AND A RARE GENETIC DISEASE.

E-Posters

E-POSTER VIEWING

Konstantinos Zachos, Nikoleta Kampouri, Polyzwis Velentzas, Tatiana Alexandrova, Kosmas Kotsonis
AGIA SOPHIA CHILDRENS HOSPITAL, First Pediatric Department, ATHENS, Greece

Title of Case: HAEMOPHILUS PARAINFLUENZA URINARY TRACT INFECTION UNMASKING UNDERLYING ANATOMIC ANOMALY AND A RARE GENETIC DISEASE.

Background: Although a common pathogen in respiratory tract infections and traditionally associated with endocarditis, Haemophilus parainfluenzae species is rarely encountered in pediatric UTIs. When isolated, it should raise suspicion for underlying pathologies.

Case Presentation Summary: A 16-months old male toddler was brought to outpatient clinic due to dysuria, genital area pruritus and distress. He was afebrile and this was his fourth visit within a short time period for the abovementioned symptoms. He was previously repeatedly treated with oral antibiotics with the diagnosis of cystitis. Urinalysis displayed leukocytosis with microorganisms and proteinuria (239 mg/dl). He was admitted in hospital, mainly for proteinuria monitoring. Following morning's urinalysis indicated cystine crystals. Urine culture was positive for Haemophilus Parainfluenza. Ultrasound examination showed renal asymmetry favoring the right kidney. Unilateral multiple scars, cortical thinning, mild hydronephrosis and hyperechogeneity to renal pyramids and calyces were observed to left kidney. Two stones (diameter 1,3cm and 0,9cm, respectively) were found in the urinary bladder. The stones appeared radiolucent in abdominal X-ray. VUGR was normal, however DMSA revealed great asymmetry in relative contribution of the two kidneys to the total renal function (15% of the left and 85% of the right kidney). Urine aminogram confirmed the diagnosis of cystinuria and the stones were removed with cystolithotomy. Patient was treated with alkalinization and antibiotic prophylaxis.

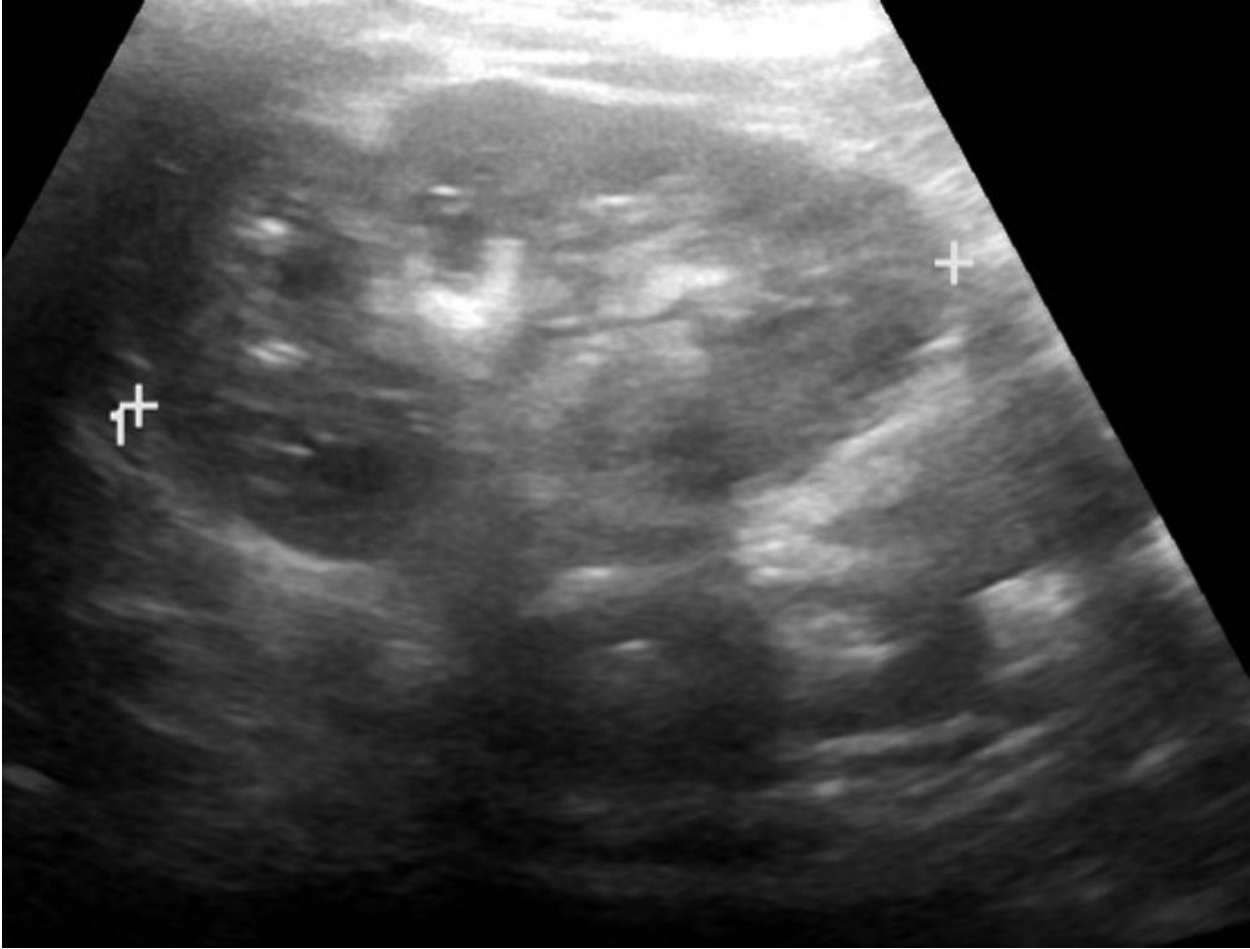



Learning Points/Discussion: It is well known that isolation of uncommon bacteria in UTIs is related with underlying anatomic anomalies. *Haemophilus parainfluenzae* been specifically associated with urinary tract stone disease and even high possibility for permanent renal damage in published pediatric and adult data. In our case, a more complex pathology, such as cystinuria was unmasked.

EP212 / #1531

Topic: AS07. Non-respiratory infections / AS07.c. CNS infections

MENINGOENCEPHALITIS AND MYOCARDITIS: SEVERE PRESENTATION FORMS OF HUMAN HERPES VÍRUS-6 INFECTION IN A HEALTHY TODDLER

E-Posters

E-POSTER VIEWING

Flávia Almeida¹, Daniel Jarovsky¹, Camila Almeida Farias¹, Ana Flávia Torres Sampaio², Bruna Cardozo Melo De Almeida², Maria Beatriz Marques Ribeiro², Marco Aurélio Palazzi Sáadi¹

¹Sabará Children's Hospital, Pediatric Infectious Diseases, São Paulo, Brazil, ²Sabará Children's Hospital, Pediatrics, São Paulo, Brazil

Title of Case: MENINGOENCEPHALITIS AND MYOCARDITIS: SEVERE PRESENTATION FORMS OF HUMAN HERPES VÍRUS-6 INFECTION IN A HEALTHY TODDLER

Background: Human herpesvirus type 6 (HHV-6) is the etiological agent of a common, benign, and self-limited febrile condition in young babies - roseola infantum. However, it can cause rare and potentially severe cases of encephalitis, meningitis, and myocardial dysfunction in immunocompetent children.

Case Presentation Summary: A 20 months-old premature girl (29 weeks) was admitted with fever and runny nose for 3 days, evolving with macular exanthema, prostration, and alternating episodes of drowsiness and irritability. At the admission, she was groaning and hypothermic (34°C), had cold extremities and had poor peripheral perfusion. Empiric high-dose ceftriaxone and acyclovir were prescribed. She was sent to the ICU where she developed cardiogenic shock, neurogenic shock, and acute pulmonary edema. Due to the severity of the clinical picture, antiviral treatment was replaced by ganciclovir on the second day of hospitalization, after the detection of herpesvirus-6 in the molecular panel. She remained hospitalized for 24 days; required mechanical ventilation for 6 days; used vasoactive and inotropic drugs, as well as high-dose immunoglobulin (2 g/kg) and methylprednisolone. The child presented satisfactory recovery of cardiac function and complete neurological recovery, without motor sequelae.

Learning Points/Discussion: HHV-6 can cause encephalitis, accompanied or not by meningitis, with the ability to generate brain epileptiform activities in immunocompetent individuals. Encephalitis and myocarditis may be caused by primary infection or reactivation, being most observed in organ transplant recipients or AIDS.

EP213 / #965

Topic: AS07. Non-respiratory infections / AS07.c. CNS infections

CONSERVATIVE MANAGEMENT OF CEREBROSPINAL FLUID SHUNT INFECTIONS IN SELECTED PEDIATRIC PATIENTS

E-Posters

E-POSTER VIEWING

Elpis Chochliourou¹, Vassilis Tsitouras², Maria Ziaka³, Eleni Tasika³, George Papaevangelou², Parmenion Tsitsopoulos², Emmanuel Roilides³, [Charalampos Antachopoulos³](#)

¹Hippokration Hospital, Pediatric Intensive Care, Thessaloniki, Greece, ²Hippokration Hospital, Department Of Neurosurgery, Thessaloniki, Greece, ³Hippokration Hospital, 3rd Dept Of Pediatrics, Aristotle University, Thessaloniki, Greece

Title of Case: CONSERVATIVE MANAGEMENT OF CEREBROSPINAL FLUID SHUNT INFECTIONS IN SELECTED PEDIATRIC PATIENTS

Background: Treatment of cerebrospinal fluid (CSF) shunt infections is challenging due to the biofilm formation. Shunt replacement is often considered the most effective approach which, however, implies prolonged hospitalization, repeated surgery and possibly other complications. A conservative management using high doses of antibiotics with good penetration in the central nervous system for prolonged period of time could, alternatively, be discussed for selected patients.

Case Presentation Summary: We present 4 patients with ventriculoperitoneal (VP) shunt infection treated with antibiotics only over the last 3 years. i) A 4-month old infant with shunt infection (*Staphylococcus epidermidis*) received linezolid and ciprofloxacin intravenously (10 days) followed by oral rifampicin (20 mg/kg/d) and cotrimoxazole (16 mg/kg/d) (3 months); ii) a 2-year old girl (cultures negative) received daptomycin (10 mg/kg/d) (7 days) followed by oral cotrimoxazole (15 mg/kg/d) (2 months); iii) a 11.5-year old girl (*Staphylococcus aureus*) received linezolid (10 days) followed by oral ciprofloxacin (500 mg bid) and rifampicin (300 mg bid) (2 months); iv) a 5.5-month old preterm infant with a history of VP shunt replacement at 4 months of age, developed again VP shunt infection (cultures negative) and received intravenously meropenem, colistin and vancomycin (2 weeks) followed by oral cotrimoxazole (15 mg/kg/d) and rifampicin (20 mg/kg/d) for 9 months. Treatment was prolonged, as there was a slow but consistent normalization of glucose and protein in repeated CSF samples. All patients were regularly monitored for blood, renal and hepatic toxicity. No recurrence of shunt infection was observed for any of these patients.

Learning Points/Discussion: In selected patients with VP shunt infection treatment can be achieved with high dose, prolonged antimicrobial therapy. The optimization of this approach warrants further study.

EP214 / #1872

Topic: AS07. Non-respiratory infections / AS07.c. CNS infections

LYME- CEREBELLAR ENCEPHALOMYELITIS A CASE REPORT

E-Posters

E-POSTER VIEWING

Babu Paturi¹, Dearbhla Byrne¹, Amir Malik², Dara Gallagher²

¹Sligo University Hospital, Paediatrics, Sligo, Ireland, ²Sligo University Hospital, Paediatrics, sligo, Ireland

Title of Case: Lyme- Cerebellar Encephalomyelitis a Case Report

Background: 5 year old boy with no significant medical history of note. Frequently plays in a forest. He was seen in emergency department one day prior to current admission with 4 day history of night time fever and on fifth day with double vision with presumed viral illness and discharged followed by readmission to paediatric ward through emergency department next day with right side tilting of head and abnormal eye movements.

Case Presentation Summary: 5yr boy with no major past medical history presented with night time fever followed by tilting of head to right side, progressive increase nystagmus, associated with veering towards right while walking and bumping into thighs around him warranted admission to paediatric ward after two emergency department visits during the week. After admission clinically deteriorated with fever, vomiting. Lumbar puncture done with CSF lymphocytosis, blood results largely unremarkable. He was started on ceftriaxone and Acyclovir IV. Fever and vomiting improved in 2 days time but ataxia and nystagmus slower to improve with some residual nystagmus on day 10 of discharge. His first MRI brain on day 2 showed mild flair on left cerebellum with no cerebellitis. Second MRI done 4 days later showed cerebellitis on left side. Blood cultures and extended CSF bacterial and viral serology PCR results were normal except lyme serology reported positive consistent with recent infection. B.Burgdorferi IgG, IgM C6 EIA, IgM p41, OSPC, OSP17 including immunoblot IgG14, VISE positive. He was treated with Ceftriaxone for 28 days with complete recovery.

Learning Points/Discussion: Patients with fever of unknown origin or with signs of encephalitis with CSF lymphocytosis lyme disease should be considered in the differential diagnosis. Include Ceftriaxone, Acyclovir in initial management till diagnostic confirmation.

EP215 / #727

Topic: AS07. Non-respiratory infections / AS07.c. CNS infections

ACUTE VENTRICULITIS ASSOCIATED WITH EXTERNAL VENTRICULAR DRAINAGE IN A 12-YEAR-OLD BOY

E-Posters

E-POSTER VIEWING

Clara Comalrena De Sobregrau¹, Carmina Guitart², Sergi Huerta², Lluïsa Hernández², Eneritz Velasco³, Miquel Villaronga², Victoria Becerra⁴, Iolanda Jordan²

¹Hospital Universitari Parc Taulí, Intensive Care Unit, Sabadell, Spain, ²Hospital Sant Joan de Déu, Intensive Care Unit, Barcelona, Spain, ³Hospital Sant Joan de Déu, Infectious Diseases, Barcelona, Spain, ⁴Hospital Sant Joan de Déu, Neurosurgery, Barcelona, Spain

Title of Case: Acute ventriculitis associated with external ventricular drainage in a 12-year-old boy

Background: We describe a case of a 12-year-old male admitted in the paediatric ICU after resection of a posterior fossa tumor and insertion of an external ventricular drainage (EVD) as a treatment of secondary hydrocephaly.

Case Presentation Summary: After one week, he presented fever and elevation of serum acute phase reactants (CPR 145mg/l, PCT 2.11ng/ml), with no signs of meningeal inflammation in cerebrospinal fluid (CSF) analysis and with *K.oxytoca* growth in urine culture. Piperacillin-tazobactam was started (280mg/kg/day) but fever did not subside. 48 hours after, CSF leukocyte count was 414/mm³, glucose 34mg/dL and protein 271mg/dL. Empirical antibiotic therapy was substituted to vancomycin (60mg/kg/day) and meropenem in extended infusion (160mg/kg/day). He developed signs of intracranial hypertension, CSF became purulent and MRI showed occupation of occipital horns with purulent material. The patient underwent decompressive craniectomy and the drainage was replaced. At this point, diagnosis of ventriculitis was reinforced by *K.aerogenes* isolation in the CSF culture and in the removed catheter. Intrathecal gentamicin was added but EVD output remained purulent, so that endoscopic ventricular lavage was performed and the drainage was replaced. CSF culture became negative 8 days after. Intrathecal gentamicin was administered for 2 weeks, together with intravenous gentamicin the first 3 days. He underwent a second endoscopic ventricular lavage 4 weeks after the initial one and received 6 weeks of systemic meropenem before definitive ventriculo-peritoneal shunt insertion. Antibiotic concentrations in CSF were monitored ensuring correct concentrations related to the MIC of the microorganism.

Learning Points/Discussion: Ventriculitis is a serious complication of invasive neurosurgical procedures. CSF culture is the most important test. Worse outcomes have been associated with lack of removal of EVD and high CSF leukocytes count.

EP216 / #817

Topic: AS07. Non-respiratory infections / AS07.c. CNS infections

EMPIRICAL TREATMENT WITH ACYCLOVIR FOR SUSPECTED HERPES SIMPLEX VIRUS ENCEPHALITIS IN PAEDIATRIC PATIENTS: REVIEW OF THE LAST 25 YEARS OF PRACTICE AT A PORTUGUESE HOSPITAL

E-Posters

E-POSTER VIEWING

Inês Gomes, Filipa Cascais, Marta Almeida, Paulo Calhau
Hospital Garcia de Orta, Paediatrics, Almada, Portugal

Backgrounds: Herpes simplex virus encephalitis (HSV-E) is a life-threatening disease, with high likelihood of serious sequelae. Prompt initiation of empirical treatment with acyclovir reduces morbimortality rates.

Methods: To review clinical presentation, laboratorial and complementary study results of paediatric patients who received acyclovir for the treatment of suspected HSV-E, at a Portuguese hospital over 25 years (1997-2021). Retrospective data collection, statistical analysis through IBM® SPSS®.

Results: 79 patients were included (44 male), aged 1 month to 17 years (mean 4 years). 12 patients had previously known conditions, mostly neurodevelopmental issues. 32 patients (41%) were diagnosed with viral encephalitis, a third of which (n=11) were positive for viral PCR in the cerebrospinal fluid (CSF). 5 patients (6% of total) had confirmed HSV infection. All patients with HSV-E had at least three symptoms of the classic clinical presentation – fever (n=5, 100%), seizures (n=5, 100%), altered behaviour (n=4, 80%), decreased consciousness (n=3, 60%) or focal neurological signs (n=3, 60%) –, differing significantly from the non-encephalitic group (post-hoc analysis, p=0,012). Non-encephalitic patients also significantly differed from HSV-E patients in CSF pleocytosis (mean 230 vs 58 cells, p=0,003) and protein levels (mean 114 vs 65 mg/dL, p=0,015). All HSV-E patients had pathological changes in electroencephalograms and neuroimaging exams. Neurologic sequelae were documented in all HSV-E cases and no deaths occurred.

Conclusions/Learning Points: These findings corroborate the notion that HSV-E usually presents with a recognizable set of clinical and exam markers, significantly differing from non-encephalitic causes of neurological dysfunction. Given the presence of suggestive findings, initiating acyclovir was globally appropriate and justified in our sample. However, HSV-E is an uncommon disease, thus future emphasis should be on timely and safe suspension of treatment, to avoid drug misuse and prevent adverse events.

EP217 / #1098

Topic: AS07. Non-respiratory infections / AS07.c. CNS infections

EVALUATION OF PEDIATRIC CASES WITH CENTRAL NERVOUS SYSTEM INFECTION DIAGNOSED BY MENINGITIS/ENCEPHALITIS MULTIPLEX PCR IN CEREBROSPINAL FLUID

E-Posters

E-POSTER VIEWING

Yalçın Kara¹, Mahmut Kizil¹, Ömer Kılıç¹, Tercan Us², Ener Dinleyici³

¹Eskişehir Osmangazi University, Pediatric Infectious, Eskişehir, Turkey, ²Eskişehir Osmangazi Medical University, Microbiology, Eskişehir, Turkey, ³Eskişehir Osmangazi University, Pediatric Intensive Care, Eskişehir, Turkey

Backgrounds: Central nervous system infections are still one of the most important causes of mortality and morbidity in children. In diagnosis, cerebrospinal fluid direct microscopy, biochemical examination, culture, and molecular tests such as Multiplex PCR panel are used. In this study, the clinical and epidemiological features of pediatric patients were evaluated with central nervous system infections detected by Multiplex PCR method in cerebrospinal fluid.

Methods: Thirty-two patients were included in Eskişehir Osmangazi University Pediatric Department between 2018-2021 years, who were diagnosed central nervous system infection with Meningitis/Encephalitis Panel Multiplex PCR in cerebrospinal fluid.

Results: Thirty-two pathogens were detected in 238 cerebrospinal fluid samples by Meningitis/Encephalitis Multiplex PCR. The mean age of the cases was 55 months and 58% were male. The most common symptoms were fever, decreased feeding, confusion, headache, and vomiting. In laboratory tests; leukocytosis 13 (41%), neutrophilia 12 (38%), lymphopenia 10 (32%), elevated CRP levels 20 (65%) were found. Findings in cerebrospinal fluid examination were; pleocytosis 30%, neutrophilia 16%, low glucose 16% and high protein 25%. Detected pathogens were Human Herpes Virus-6 in 11 cases, Enterovirus 8, Streptococcus pneumoniae 5, Varicella Zoster 2, Cytomegalovirus 2, Haemophilus influenzae 1, Streptococcus agalactiae 1, Listeria monocytogenes 1, Staphylococcus epidermidis 1. There was growth in cerebrospinal culture in five of 32 cases. The most commonly used antimicrobial therapy were ceftriaxone/cefotaxime, vancomycin, ampicillin and acyclovir. Empirical antibiotic treatment was stopped in eight cases due to the detection of virus by Multiplex PCR.

Conclusions/Learning Points: The most common pathogens in central nervous system infections in children are viruses and bacteria. Multiplex PCR is one of the most specific methods for detecting pathogens especially viral agents. With the use of Multiplex PCR method, the unnecessary use of antibiotics has been reduced.

EP218 / #1080

Topic: AS07. Non-respiratory infections / AS07.c. CNS infections

POSTERIOR REVERSIBLE ENCEPHALOPATHY SYNDROME: A RARE COMPLICATION OF INVASIVE PNEUMOCOCCAL INFECTION

E-Posters

E-POSTER VIEWING

Maria Kourti^{1,2}, Elias Iosifidis^{1,2}, Eleni Tasika¹, Eleni Vagdatli³, Athanassia Anastasiou⁴, Charalampos Antachopoulos^{1,2}, Emmanuel Roilides^{1,2}

¹Aristotle University of Thessaloniki, Third Department Of Pediatrics, Thessaloniki, Greece, ²Aristotle University of Thessaloniki, Infectious Diseases Unit, Thessaloniki, Greece, ³Hippokration General Hospital, Department Of Microbiology, Thessaloniki, Greece, ⁴Hippokration General Hospital, Department Of Radiology, Thessaloniki, Greece

Title of Case: POSTERIOR REVERSIBLE ENCEPHALOPATHY SYNDROME: A RARE COMPLICATION OF INVASIVE PNEUMOCOCCAL INFECTION

Background: Posterior reversible encephalopathy syndrome (PRES) is a clinical-radiological entity, presented with altered consciousness, hypertension and characterized by white matter vasogenic edema.

Case Presentation Summary: A 22-month old febrile infant was referred to our hospital for altered mental status, vomiting and poor feeding with otitis media. Clinical examination revealed nuchal rigidity and Kernig's sign, suggestive of central nervous system involvement. Based on presumed diagnosis of bacterial meningitis, she was immediately treated with iv dexamethasone and ceftriaxone. A lumbar puncture (LP) was performed, cerebrospinal fluid (CSF) analysis demonstrated low glucose level (<1 mg/dl), elevated protein concentration and a leukocyte count of 200cells/ μ L. Gram stain of the CSF revealed Gram-positive diplococci. Culture and Polymerase chain reaction (PCR) tests of the CSF and blood were positive for *Streptococcus pneumoniae* with penicillin MIC 0.06 mg/l (susceptible). Although, her clinical condition gradually improved, on hospital day 4 her clinical condition worsened, with hypertension (Blood Pressure 145/80mmHg), generalized hypotonia, lethargy and diminished spontaneous speech. A brain MRI and repeat LP were performed to rule out any complication of the disease. T2/FLAIR (fluid-attenuated inversion recovery) images showed bilateral subcortical lesions consistent with vasogenic edema and posterior reversible encephalopathy syndrome (PRES). Mannitol was added. She recovered and completed the antibiotic treatment for ten days and discharged. Serotyping revealed a non-vaccine serotype 15A. Follow-up MRI (T2 and FLAIR) revealed complete resolution of the previous diffuse, hyperintense lesions, confirming the diagnosis of PRES.

Learning Points/Discussion: PRES is a rare complication of invasive pneumococcal disease (IPD) and should be promptly recognized since it is reversible and treatable. The occurrence of IPD with serotype replacement not included in the PCV-vaccine needs further monitoring.

EP219 / #1199

Topic: AS07. Non-respiratory infections / AS07.c. CNS infections

A 5-YEAR-OLD WITH A SEVERE COMPLICATION OF OTITIS MEDIA

E-Posters

E-POSTER VIEWING

Joanna Mańdziuk, Magdalena Okarska-Napierała, Ewa Zalewska, Ernest Kuchar
Medical University of Warsaw, Department Of Pediatrics With Clinical Assessment Unit, Warsaw, Poland

Title of Case: A 5-year-old with a severe complication of otitis media

Background: Acute bacterial meningitis is the most common infectious disease of the central nervous system (CNS) and develops after the pathogen enters CNS through hematogenous spread or by direct extension of sinusitis, mastoiditis, or otitis media.

Case Presentation Summary: We admitted a 5-year-old boy due to fever and pain of the left ear for four days before admission. His general condition gradually worsened with drowsiness observed. On admission, the boy was disoriented, otitis media of the left ear, and meningeal signs were present. Laboratory tests revealed very high markers of inflammation (C-reactive protein: 33.5 mg/dL). On the head computed tomography (CT), no air cells in the left temporal bone were seen, fluid in the left middle ear and brain edema were present. Cerebrospinal fluid (CSF) examination showed typical aberrations for bacterial meningitis. Ceftriaxone and vancomycin were administered. *Streptococcus pneumoniae* was identified in CSF by polymerase chain reaction test and later in blood culture. On the fifth day of the treatment, after temporary improvement, the fever reappeared. Head CT showed massive inflammation of the left mastoid and left tympanic cavity with decalcification and thinning of the bone plaque separating these structures from the middle cranial cavity. Antromastoidectomy was performed with ventilation drainage of the left ear. Histopathology examination revealed cells that can be present in granulomatosis with polyangiitis (ANA, ANCA negative). However, the patient's condition improved over the next few days, and he fully recovered.

Learning Points/Discussion: A typical child's infection such as otitis media may complicate with severe sequelae, including meningitis. Antibiotic therapy alone may not be sufficient in all cases, and surgical procedures are necessary for selected patients, particularly those non-responding to conservative treatment.

EP220 / #1209

Topic: AS07. Non-respiratory infections / AS07.c. CNS infections

A 6-YEAR-OLD BOY WITH AN UNCOMMON CAUSE OF MENINGITIS

E-Posters

E-POSTER VIEWING

Joanna Mańdziuk¹, Magdalena Okarska-Napierała¹, Anna Piwowarczyk¹, Aneta Wachnik², Ernest Kuchar¹

¹Medical University of Warsaw, Department Of Pediatrics With Clinical Assessment Unit, Warsaw, Poland, ²Medical University of Warsaw, Department Of Laboratory Diagnostics And Clinical Immunology Of Developmental Age, Warsaw, Poland

Title of Case: A 6-year-old boy with an uncommon cause of meningitis

Background: Bacterial meningitis remains a significant cause of children's death worldwide. Most cases in children are due to *Streptococcus pneumoniae*, *Neisseria meningitidis*, and *Hemophilus influenzae*. *Streptococcus intermedius* is a member of the *Streptococcus anginosus* group (SAG) and normally colonizes oral cavity, upper respiratory tract, and gastrointestinal tract. However, it can cause life-threatening infections, mainly liver and brain abscesses.

Case Presentation Summary: We admitted a previously healthy 6-year-old boy with fever, headache, and right ear pain for five days before admission. The child was gradually becoming weak and lethargic. On admission, the patient was drowsy; nuchal rigidity and positive Kernig sign were observed with no signs of focal neurological deficits. Laboratory tests revealed high markers of inflammation. Cerebrospinal fluid (CSF) examination showed typical aberrations for bacterial meningitis. Ceftriaxone, vancomycin, and dexamethasone were administered. The patient's condition gradually improved, however drooping of the left mouth corner appeared, and the headache persisted. Computed tomography excluded brain abscess. CSF culture was initially negative but after adding fructooligosaccharides, *Streptococcus intermedius* was identified. The same pathogen was cultured from the blood. On the 6th day of treatment, fever reappeared with cough, dyspnea and crepitations on auscultation. A PCR test confirmed the respiratory syncytial virus (RSV). Symptomatic treatment was added, including oxygen therapy. The patient fully recovered.

Learning Points/Discussion: Occasionally, typical human microbiota pathogens like *Streptococcus intermedius* can cause meningitis, even in previously healthy individuals with no predisposing risk factors. Empirical treatment for meningitis is effective also in an infection caused by *S. intermedius*. SAG infections may be under-recognized, therefore special procedures for SAG detection should be provided. Interestingly, RSV infection had a rather severe course for a 6-year-old, perhaps due to preceding disease.

EP221 / #1530

Topic: AS07. Non-respiratory infections / AS07.c. CNS infections

PREVENTABLE H. INFLUENZAE MENINGITIS IN 20 MONTH-OLD UNVACCINATED PATIENT: CASE REPORT

E-Posters

E-POSTER VIEWING

Helena Martin^{1,2}, Anna Morera Leralta², Livia Chrast², Lorena Cova², Alberto Canciani², Christelle Sallin², Mascha Rochat², Gillian Szita-Rapaj²

¹Hôpital Intercantonal de la Broye, General Pediatrics, Payerne, Switzerland, ²Hôpital Intercantonal de la Broye, Pediatrics, Payerne, Switzerland

Title of Case: PREVENTABLE H. INFLUENZAE MENINGITIS IN 20 MONTH-OLD UNVACCINATED PATIENT: CASE REPORT

Background: Haemophilus influenzae (Hi) is an obligate human pathogen that colonises the nasopharynx of healthy subjects and includes six encapsulated serotypes (a-f), as well as several non-encapsulated serotypes (nChi). In the pre- vaccine era, H influenzae serotype b (Hib) was the most common cause of invasive H influenzae infection occurring almost exclusively in children under 5 years of age. The HIB conjugate vaccine was introduced in the early 1990s, resulting in a drastic reduction in the incidence of the disease in its invasive form and, respectively, an increase in the frequency of infections with nChi strains

Case Presentation Summary: We report the case of an immunocompetent, unvaccinated patient aged 1 year and 8 months who was admitted to the emergency department with a reduced level of consciousness after 36 hours of drowsiness, fever and vomiting. He had been initially diagnosed with viral gastroenteritis and an otitis media which was not treated the previous day. Physical examination revealed an axial atony and divergent eye fixation. The lumbar puncture showed high protein levels and 81% of polynucleated leukocytes. Empiric antibiotherapy (ceftriaxone) and corticotherapy (dexamethasone) were administered. A cerebral CT scan showed an untreated otitis media and ethmoidal sinusitis. Serotyping of hemophilia found in the spinal fluid and blood revealed serotype type b.

Learning Points/Discussion: Efforts to keep the incidence of invasive Haemophilus influenzae type B meningitis low should be directed to maintaining a high level of vaccination coverage, especially among children under 2 years of age.

EP222 / #1027

Topic: AS07. Non-respiratory infections / AS07.c. CNS infections

TRENDS IN MENINGITIS IN INFANTS

E-Posters

E-POSTER VIEWING

Susan Wakeham¹, Kevin Meesters², Stephanie Bourne³, Hana Mitchell¹, Manish Sadarangani⁴, Jennifer Smitten⁵

¹University of British Columbia, Pediatric Infectious Disease, Vancouver, Canada, ²BC Children's Hospital/University of British Columbia, Department Of Pediatrics Infectious Diseases, Vancouver, Canada, ³Dalhousie University, Department Of Pediatrics, Halifax, Canada, ⁴BC Children's Hospital, Vaccine Evaluation Center, Vancouver, Canada, ⁵University of British Columbia, Department Of Pediatrics, Vancouver, Canada

Backgrounds: Aim: To analyze clinical and microbiological outcomes of infants <3 months treated for meningitis in a tertiary children's hospital.

Methods: Infants <90 days admitted between 2013-2018 for either confirmed (positive cerebrospinal (CSF) culture and/or polymerase chain reaction), probable (CSF pleocytosis with a positive blood culture) or possible (clinical suspicion, but no microbiological confirmation) meningitis were eligible for inclusion. Infants with ventriculoperitoneal (VP) shunts and with single CSF cultures revealing a skin bacterium were excluded. Clinical and microbiological outcomes data were analyzed.

Results: Data of 80 infants (median age 18 days) were available. Meningitis was confirmed in 36, probable in 15 and possible in 29 infants. 65 children had at least 1 lumbar puncture (LP), 48 of which received prior antibiotics. Group B Streptococcus (GBS) was the most frequent pathogen (28 cases, 25 late onset), followed by Escherichia coli (26 cases) and Streptococcus pneumoniae (5 cases). Seizures were more frequent for S. pneumoniae than GBS or E. coli (60%, 32%, and 31%, respectively). 29 patients had long-term neurological sequelae. Within 3 weeks of completion of treatment 7 children experienced relapse: 2 GBS, 4 E. coli, 1 S pneumoniae. 9 infants died, 3 with GBS and 5 with E. coli.

Conclusions/Learning Points: GBS, E. coli, S. pneumoniae were the most common pathogens in our cohort (35%, 33%, and 6%, respectively). Morbidity and mortality were high; 11% died during treatment and 36% suffered long term neurologic sequelae. Mortality was highest in patients with E. coli, followed by GBS, and seizures were most frequent in those with S. pneumoniae. Rapid initiation of empiric antibiotic treatment including a third generation Cephalosporin, followed by an LP as soon as possible, remains important in suspected bacterial meningitis.

EP223 / #791

Topic: AS07. Non-respiratory infections / AS07.c. CNS infections

HAEMOPHILUS INFLUENZAE TYPE B SEVERE SEPSIS AND MENINGITIS IN A VACCINATED AND IMMUNOCOMPETENT CHILD: A CASE REPORT.

E-Posters

E-POSTER VIEWING

André Morais¹, Cristina Rodrigues¹, Augusta Gonçalves¹, Helena Silva¹, Vera Baptista², Arnaldo Cerqueira²

¹Hospital de Braga, Pediatrics, Braga, Portugal, ²Hospital de Braga, Pediatric Intermediate Care Unit, Braga, Portugal

Title of Case: HAEMOPHILUS INFLUENZAE TYPE B SEVERE SEPSIS AND MENINGITIS IN A VACCINATED AND IMMUNOCOMPETENT CHILD: A CASE REPORT.

Background: Haemophilus influenzae are gram-negative coccobacilli that commonly colonize children's nasopharynx. Haemophilus influenzae type b (Hib) was the leading cause of bacterial meningitis in children. After the Hib vaccine, in 1985, the epidemiology shifted and the incidence of invasive Hib disease has dramatically decreased. Nowadays, non-typeable Haemophilus influenzae are now the major cause of invasive disease across all age groups.

Case Presentation Summary: Previously healthy 16 months old male toddler, vaccinated for Hib (3 doses) was admitted to our emergency department with fever and vomiting with 17 hours of evolution. At presentation, a rapid general status deterioration, along with altered conscience, were noticed. The examination was consistent with severe sepsis. After running sepsis workup, he started treatment with intravenous antibiotics and fluids. No leukocytosis, a CRP of 105 mg/L and hyperlactatemia of 6,71 mmol/L on the first hour lab results. Blood culture was positive to Hib. The cerebrospinal fluid analysis showed pleocytosis and high protein level. Haemophilus influenzae was also detected in the cerebrospinal fluid by PCR DNA amplification. He still spiked fever after 1 week. After 4 days in Intermediate Unit Care he was transferred to the Pediatrics department to complete antibiotic treatment - 21 days of ceftriaxone. Brain MRI showed diffuse leptomeningeal enhancement, subdural effusion and a left otomastoiditis, probably related with the inflammatory/infectious process. The hearing screening was normal.

Learning Points/Discussion: Haemophilus influenzae is still an important cause of invasive disease in children, despite the widespread use of the Hib vaccine. Specially in children less than 2 years, haemophilus influenzae and other capsulated bacterias should be considered and treated promptly due to the higher risk of infective and neurological complications.

EP224 / #561

Topic: AS07. Non-respiratory infections / AS07.c. CNS infections

CSF CYTOKINES IN THE DIAGNOSIS OF BACTERIAL AND ASEPTIC MENINGITIS IN CHILDREN

E-Posters

E-POSTER VIEWING

Oleksandr Nadraga

Lviv National Medical University, Pediatric Infection Diseases, Lviv, Ukraine

Backgrounds: The urgency of the problem of meningitis in children is due to the high frequency of severe forms of the disease, high mortality, the difficulty of differential diagnosis. Some studies confirmed the presence of cytokines in the cerebrospinal fluid and found a correlation between the concentrations of these cytokines and the severity of disease.

Methods: The prospective study covered 73 patients aged 6 - 18 y.: 47 children with aseptic meningitis, 26 - with purulent meningitis. Clinical peculiarities, cytokine profile of CSF were revealed. The concentration of cytokines (IL-4, IL-1b, IL-10, TNF- α) in liquor was determined during the first day of hospital stay.

Results: In patients with purulent meningitis levels of TNF α , IL-1 β , IL-4, IL-10 were significantly higher than in patients with aseptic meningitis, special attention should be paid to IL-1 β , which median concentration was by 16 times higher than that of patients with aseptic meningitis. In patients with purulent meningitis, the ratio of IL10/TNF α during the first days from the onset of the disease was 4.68 ± 1.02 units, and was significantly lower than in patients with aseptic meningitis (23.35 ± 2.08 units). We observed the positive correlation between score on Glasgow Coma Scale and IL-1b concentration ($r = 0,66$, $p < 0,01$), IL-10 ($r = 0,34$, $p < 0,01$), TNF- α ($r = 0,82$, $p < 0,05$).

Conclusions/Learning Points: In clinical practice inflammatory cytokines levels in CSF could be used as a diagnostic variable before the results of culture are available especially in cases where the cerebrospinal fluid examination is inconclusive. Highly informative is index IL10 /TNF- α which reflects the state of the T-helper system in patients with meningitis.

EP225 / #857

Topic: AS07. Non-respiratory infections / AS07.c. CNS infections

RELAPSING REMITTING FEBRILE ENCEPHALITIS: A RELAY RACE HAPPENING UP THERE, WHERE WILL IT END?

E-Posters

E-POSTER VIEWING

Gajanand Singh Tanwar¹, Palak Patel¹, Surendra Godara², Rakesh Saharan², Priya Tanwar¹
¹S. P. Medical College,, Pediatrics, BIKANER, India, ²Maharaja Agrasen Medical College, Pediatrics, Agroha, India

Title of Case: RELAPSING REMITTING FEBRILE ENCEPHALITIS: A RELAY RACE HAPPENING UP THERE, WHERE WILL IT END?

Background: Neurocysticercosis (NCC) is the most prevalent parasitic infestation of central nervous system (CNS) caused by the larval form of *Taenia Solium*. The clinical course of disease runs from being asymptomatic to life threatening manifestations. This case report presents the atypical relapsing encephalitis form of this typical CNS infection with long term complications on cognition and behavior.

Case Presentation Summary: A 7 year old boy with miliary neurocysticercosis (NCC) presented with recurrent encephalitic episodes in a three year follow up period. Going through the atypical spectrum of disease, child showed all the symptoms of encephalitis along with psychiatric disarray in the long run. This was further donned by the typical presentation of “starry sky” in his neuroimaging on diagnosis followed by ventricular enlargement and subsequent clearance radiologically. The child was debarred from providing antihelminthic therapy and was managed with corticosteroids and intravenous mannitol, with gradual improvement. The clinical presentation was complicated by recurrent episodes of encephalitis in a span of 36 months and thus warranted the use of multiple courses of corticosteroids accordingly. The child was left with impaired cognition, behavioural disturbances and depressed intellect with a considerable fall in his intelligence quotient.

Learning Points/Discussion: All the paediatricians to have a high index of suspicion about the varied manifestations to diagnose it timely for avid management and adequate follow up to prevent permanent social and mental handicap, this disease brings.

EP227 / #1632

Topic: AS07. Non-respiratory infections / AS07.d. Sepsis, systemic and multi-organ infections

AN UNCOMMON CASE OF SEPSIS DUE TO SALMONELLA

E-Posters

E-POSTER VIEWING

Inês Azevedo, Sara Araújo, Magalys Pereira, Catarina De Figueiredo, Sónia Aires, Virginia Monteiro, Lúcia Gomes
Centro hospitalar entre douro e Vouga, Paediatric, Santa Maria da Feira, Portugal

Title of Case: An uncommon case of sepsis due to Salmonella

Background: Acute gastroenteritis by non-typhoid Salmonella is one of the most common infections in the paediatric population. Generalized forms are rare, representing only 1% of infections, and occur mainly in immunodepressed children.

Case Presentation Summary: A 16-year-old male adolescent with a previous history of asthma and allergic rhinitis was observed in the emergency department due to ongoing diarrhea, without blood or mucus, in the past month. In addition, he presented fever (maximum temperature of 39.8°C), asthenia, nasal obstruction and cough with 4 days of evolution. Besides the previous symptoms, he reported vomiting and myalgias, since the day of the admission. He was tachycardic, dehydrated and the lower abdominal quadrants were painful. In the analytical study, he presents leukopenia ($3 \times 10^9/L$) with lymphopenia ($0.67 \times 10^9/L$), thrombocytopenia ($106 \times 10^9/L$) and elevation of liver enzymes (AST 83U/L; ALT 86U/L; GGT 74U/L; Alkaline phosphatase 258U/L). It also showed an increased ferritin (551ng/mL), D-dimers (7479ng/ml), pro-BNP (862mg/dl) and PCR (150mg/L). He underwent chest x-ray, abdominal ultrasonography and echocardiogram without major alterations. He tested negative for SARS-CoV-2 (PCR). After evaluation by Infeciology and Cardiology, the hypothesis of MIS-C was excluded. He was admitted to the Pediatric Service on suspicion of sepsis with gastrointestinal starting point. During hospitalization, he confessed the ingestion of 8-10 homemade eggs per day in the last month. Blood culture and coproculture showed growth of Salmonella enterica serotype Panama multisensitive. He completed 14 days of intravenous ceftriaxone, with progressive clinical improvement.

Learning Points/Discussion: Salmonella septicemia is a serious and rare complication in immunocompetent children. The most common infectious foci are gastrointestinal, pericardial, meningeal, bone or articular. This clinical case illustrates a rare and atypical complication of acute gastroenteritis due to Salmonella in an adolescent.

EP228 / #482

Topic: AS07. Non-respiratory infections / AS07.d. Sepsis, systemic and multi-organ infections

BEFORE THE SHOCK – FEVER AND RASH

E-Posters

E-POSTER VIEWING

Sandra Catarina Ferraz¹, Inês Correia Magalhães¹, Rita Aldeia Da Silva^{1,2}, Sofia Miranda¹, Cátia Silva¹, Mariana Costa¹

¹Unidade Local de Saúde do Alto Minho, Pediatrics, Viana do Castelo, Portugal, ²Hospital de Braga, Paediatrics, Braga, Portugal

Title of Case: Before the shock – fever and rash

Background: Staphylococcal toxic shock syndrome (TSS) is a clinical illness characterized by rapid onset of fever, rash, hypotension, and multiorgan system involvement. At least half of reported staphylococcal TSS cases are not related to menstruation, and they may occur in a variety of clinical circumstances.

Case Presentation Summary: A previously healthy 8-year-old male, presented with a high fever and a rash for two days, and two vomiting episodes on the day of admission. The patient had a history of a fall a week earlier. Upon physical examination, he had good clinical appearance and a maculopapular rough rash was evident, with coalescent lesions in the genital area, a localized area of papular lesions with crusting and inflammatory signs in the posterior thoracic region, tonsillar hyperemia and a strawberry tongue. On admission, the cardiovascular monitoring revealed tachycardia with normal blood pressure. The blood analysis revealed anemia, thrombocytopenia, elevated BUN, transaminases, PCR, and procalcitonin. We began empiric antibiotic therapy with flucloxacillin and clindamycin, and fluid therapy. Several hours later, the patient started hypotension, tachycardia and prostration, and needed fluid bolus for cardiovascular stabilization.



The skin lesions found are the probable cause of infection. Five days after hospitalization the rash began desquamation and a low-grade peripheric edema was found. We chose the empiric antibiotic scheme

admitting a staphylococcal toxic shock syndrome and the low local prevalence of community acquired MRSA. Blood and urine cultures were both negative.

Learning Points/Discussion: It is necessary to have a high alert level to TSS cases before clinical aggravation. Not every infancy exanthem is benign and a prompt diagnosis and commencement of therapy can change the course of the illness.

EP229 / #436

Topic: AS07. Non-respiratory infections / AS07.d. Sepsis, systemic and multi-organ infections

INVASIVE PNEUMOCOCCAL DISEASE IN CHILDREN- 7 YEARS EXPERIENCE FROM A TERTIARY CARE CENTER IN SOUTH INDIA

E-Posters

E-POSTER VIEWING

Vithiya Ganesan

Velammal Medical College Hospital and Research institute, Microbiology, Madurai, India

Backgrounds: The aim of the present study was to investigate the epidemiology, clinical characteristics and microbiological findings among children with invasive pneumococcal infections in a tertiary care centre from South India.

Methods: The study was carried out over a period of seven years from January 2015 to December 2021. This is a retrospective observational chart review of patients diagnosed with invasive pneumococcal infection. The electronic medical records of all patients were examined. Ethics committee approval was obtained for the study. Blood specimens were processed on BACTEC FX40 system (BD) as per standard protocols. *S. pneumoniae* identification and antimicrobial susceptibility testing was performed using the VITEK system 2 (biomerieux, France).

Results: Of 12 children with IPD, 7 were <5 years of age. Male to female ratio was 7:5. Though the clinical presentation was varied, 11 patients had bacteremia and, among them, 3 had pneumonia, and 1 had meningitis. Comorbidities include malnutrition, decompensated liver disease, nephrotic syndrome, postoperative infection (Kasai procedure for biliary atresia). Overall non-susceptibility (including resistance and intermediate susceptibility) to penicillin was noted in 5 isolates (41.6%). Three isolates (25%) were non-susceptible to ceftriaxone and cefotaxime. Erythromycin, co-trimoxazole, tetracycline resistance was noted to be as high as 91.6%, 75% and 66.6% respectively. CSF isolate was sensitive only to vancomycin and linezolid. Multidrug resistant (MDR) isolates (resistance to ≥ 3 antibiotics) accounted for 66.6% Among 12 patients, 8 patients survived, 3 (< 1 year age) died and one patient was discharged at request against medical advice, and no follow-up was possible.

Conclusions/Learning Points: Mortality due to invasive pneumococcal disease in under five children is very high. So the importance of pneumococcal vaccine in the 1st year of life cannot be overlooked.

EP230 / #1196

Topic: AS07. Non-respiratory infections / AS07.d. Sepsis, systemic and multi-organ infections

A CASE OF NON-TYPHOID SALMONELLA SEPTIC ARTHRITIS IN AN IMMUNOCOMPETENT CHILD

E-Posters

E-POSTER VIEWING

Magda Sarukhanyan, Sirarpi Shahgeldyan, Arusyak Vardanyan, Yelena Toroyan, Hrachuhi Ghazaryan
Wigmore Clinic, General Pediatrics, Yerevan, Armenia

Title of Case: A case of non-typhoid salmonella septic arthritis in an immunocompetent child

Background: Non-typhoid Salmonella (NTS) is a common cause of acute bacterial gastroenteritis, usually self-limited in immunocompetent hosts. The rate of septic arthritis due to Salmonella is lower than other gram-negative bacteria (0.1% - 0.2%). Bacteremia and focal extraintestinal NTS infections may occur in 1% - 5% of cases, especially at a younger age, in immunocompromised children and those with hemoglobinopathies. The treatment consists of antibiotic therapy and surgical interventions.

Case Presentation Summary: Previously healthy 7-month old boy was admitted to the clinic with a 13 day history of fever, persistent diarrhea, and left knee swelling, which developed on the 11th day of illness. No history of trauma. No known family history of hemoglobinopathy or immunodeficiency. Physical examination revealed right knee arthritis with right inguinal lymphadenopathy. Other joints were not involved. Initial lab tests revealed mild anemia (HGB 90 g/l), normal CBC and liver function tests, inflammation (CRP 64.9 mg/l). Stool PCR detected Salmonella spp. Knee ultrasound showed moderate effusion, synovial thickening, and nodularity. The treatment was started with Ceftriaxone 100 mg/kg /day while results of cultures were pending. Urgent arthroscopic joint lavage was performed. Synovial fluid and stool culture were both positive for Salmonella enteritidis and sensitive to Amoxicillin/Clavulanic acid, Ceftriaxone, Moxifloxacin. The patient received Ceftriaxone for 4 weeks the switched to oral Amoxicillin/Clavulanic acid for 2 weeks. At 3-month follow-up the right knee was fully recovered, laboratory tests were normal.

Learning Points/Discussion: NTS burden is high especially in developing countries like Armenia. Clinicians should be aware of rare NTS complications such as bacteremia and focal extraintestinal infections.

EP231 / #1410

Topic: AS07. Non-respiratory infections / AS07.d. Sepsis, systemic and multi-organ infections

FEVER, HEADACHE, MIYALGIA, EXANTHEMA : A RICKETSIA CASE DURING PANDEMIC, MISC ?

E-Posters

E-POSTER VIEWING

Mahmut Kizil¹, Berkay Bulut², Perihan Elmaağaç², Ersin Yüksel³, Yalçın Kara¹, Tercan Us⁴, Coşkun Yazar⁵, Ömer Kılıç⁶, Ener Cagri Dinleyici⁷

¹Eskişehir Osmangazi University, Pediatric Infectious, Eskişehir, Turkey, ²Eskişehir osmangazi university, Pediatrics, Eskişehir, Turkey, ³Eskişehir osmangazi university, Pediatric Neurology, eskişehir, Turkey, ⁴Eskişehir Osmangazi Medical University, Microbiology, Eskişehir, Turkey, ⁵Eskişehir osmangazi university, Pediatric Neurology, Eskişehir, Turkey, ⁶Eskişehir Osmangazi Medical University, Pediatric Infectious, Eskişehir, Turkey, ⁷Eskişehir Osmangazi University Faculty of Medicine, Department Of Pediatrics, Eskişehir, Turkey

Title of Case: Fever, Headache, Myalgia, exanthema : A rickettsia case during pandemic MISC ?

Background: Rickettsia species are gram-negative intracellular, small pleomorphic coccobacilli. Rickettsia conorii in the spotted fever group was reported to cause mediterranean spotted fever in Europe, especially in mediterranean countries including Turkey. The major vectors of Rickettsia species are ticks, in some species fleas or mites.

Case Presentation Summary: A 17-year-old male patient presented with complaints of severe headache, diffuse myalgia, and fever for 1 week. he had headache about 1 month but get severe in last week, and he works in forest and complain about insect bites. In examination, he has suspicious stiff neck, muscle tenderness, and petechial exanthems just bilateral forearm. In first laboratory; leucocyte 6500/mm³ , trombocyte 122000/mm³, CRP 148 mg/L, ALT 163 U/L, ferritin 1089 ng/mL, fibrinogen 494 ng/dL, D-dimer 15,9 mg/L, eritrocyte sedimentation rate 20 mm/hour. In progress headache was continued and he complained for blurred vision. Enlarged perioptical CSF areas in MRI and grade 1 papilledema was detected. CSF sampling was done for fever and headache. CSF findings was normal but CSF pressure was measured as 34 cmH₂O. Acetazolamide treatment was given for increased intracranial pressure. For insect bites, fever, petechial exanthem, myalgia, serology was studied for Crimean-Congo hemorrhagic fever and Rickettsial pathogens. Rickettsia conori IgM ELISA was detected as 1/192 and doxycycline treatment was given for 10 days. For severe myalgia, non-steroidal anti-inflammatory drugs was started. Blood and CSF cultere was negative. In progress patients' symptoms regressed.

Learning Points/Discussion: In pandemic era , patients considered mostly for common diseases, but detailed anamnesis should be taken. We present a case which is presented in similar findings with MIS-C and other infectious diseases but anamnesis lead us to specific serology tests.

EP232 / #598

Topic: AS07. Non-respiratory infections / AS07.d. Sepsis, systemic and multi-organ infections

STAPHYLOCOCCUS AUREUS BACTEREMIA IN PEDIATRICS - SABA-PED.

E-Posters

E-POSTER VIEWING

Isabel Mellado, Carlos Grasa, Luis Escosa-García, Emilio Cendejas, Teresa Del Rosal, Fernando Baquero-Artiago, Ana Méndez-Echevarría, Julio García-Rodríguez, Maria Jose Mellado, Cristina Calvo
Hospital Universitario La Paz, Paediatric Infectious Diseases Unit, Department Of Paediatrics, Madrid, Spain

Backgrounds: Staphylococcus aureus is an important cause of bacteremia in children. Risk factors, complications and management are poorly described compared to adult population. Our aim was to describe the episodes and outcomes of S. aureus bacteremia (SAB) in our pediatric population, including morbidity and mortality up to 90 days after SAB.

Methods: Descriptive and retrospective study of SAB in a tertiary pediatric hospital in Spain, January 2016-December 2020.

Results: Forty SAB cases were identified in 33 patients, 50% female cases. Median age was 7 years (IQR 2.1–12.8), and median duration of hospitalization was 19 days (IQR 13–62). Comorbidities affected 90% (35% short bowel syndrome, 15% severe skin conditions); 83% had a central venous line. Most common source of infection was catheter related infection (CRI)(58%) followed by skin and soft tissue infection (18%). Six episodes (15%) were caused by methicillin-resistant S. aureus. Most prescribed antibiotics were vancomycin (53%) as empirical therapy and cloxacillin (38%) for targeted therapy (figure1). Median antibiotic duration was 17 days (IQR 14-41), while median intravenous duration was 15 days (IQR 9.5-20.5). Switch to oral antibiotic was performed in 16 cases (40%) after a median of 14 days (IQR 7-34). Complications were present in 50% of the cases (pneumonia, osteoarticular infection, sepsis...). Only two cases presented a complication after oral switch (complicated osteomyelitis and CRI). CRP at day 7 was significantly lower in non-complicated cases ($p=0.044$). One patient died although death was not directly related to SAB.

Conclusions/Learning Points: Most pediatric patients with SAB had significant comorbidities and central venous catheters. Half of the cases developed complications but no mortality due to SAB. Among patients with uncomplicated infection and low CRP, switch to oral antibiotics could be considered.

EP233 / #991

Topic: AS07. Non-respiratory infections / AS07.d. Sepsis, systemic and multi-organ infections

**PENICILLIN-SUSCEPTIBLE STREPTOCOCCUS GALLOLYTICUS PASTEURIANUS (SGP)
BACTEREMIA OCCURRING CONCOMMMENTLY WITH AMOXICILLIN TREATMENT**

E-Posters

E-POSTER VIEWING

William Novotny

Brody East Carolina School of Medicine, Pediatrics, Greenville, United States of America

Title of Case: PENICILLIN-SUSCEPTIBLE STREPTOCOCCUS GALLOLYTICUS PASTEURIANUS (SGP) BACTEREMIA OCCURRING CONCOMMMENTLY WITH AMOXICILLIN TREATMENT

Background: SGP is normal flora in the human bowel but seldom a pathogen in the setting of immunocompetency. In adults with gastrointestinal lesions, bacterial translocation may cause bacteremia, meningitis or endocarditis. Enemas have been reported to cause bacterial translocation or bowel perforation and peritonitis.

Case Presentation Summary: At 11-months of age, a healthy child with post-hemorrhagic hydrocephalus was instrumented with a ventriculoperitoneal shunt (VPS). At 14-months of age constipation developed which mother treated with a tap water enema. Later that day, acute febrile otitis was diagnosed and treated with amoxicillin 90 mg/kg/day. After 2 days of amoxicillin mother noted the abdomen to be distended, "shiny" and "exquisitely tender". The following days were characterized by continued abdominal findings, fussiness and fever. On the ninth day of amoxicillin, a fever of 105.9F was recorded and blood cultures were obtained which grew SGP. The minimum inhibitory concentration to penicillin-G was 0.120 microgram/mL ("susceptible") and ceftriaxone <0.125 micrograms/mL ("susceptible"). Urine culture was sterile. Ceftriaxone and vancomycin were administered. Afterward a lumbar puncture revealed no organisms on gram stain but 5,268 total nucleated cells/microliter with 98% neutrophils, glucose 49 mg/dL (60-80), protein 133 mg/dL (15-45). No bacteria grew from spinal fluid. The following day the shunt was removed, and ventricular fluid had 49/microL nucleated cells with 6% neutrophils and sterile culture. Echocardiogram was normal. After 14 days of ceftriaxone a VPS was re-inserted.

Learning Points/Discussion: High-dose amoxicillin treatment failed to prevent "penicillin-susceptible" SGP bacteremia and possibly development of SGP meningitis/ventriculitis in the presence of an indwelling VPS. Enemas may predispose to SGP translocation into the bloodstream and thereafter to the cerebrospinal fluid or direct transmural seeding of the peritoneal cavity.

EP234 / #1584

Topic: AS07. Non-respiratory infections / AS07.d. Sepsis, systemic and multi-organ infections

AN UNEXPECTED CASE OF INFECTIVE ENDOCARDITIS IN A TERCIARY HOSPITAL

E-Posters

E-POSTER VIEWING

Inês Pedrosa¹, Teresa Monteiro², Regina Pinto Silva³, Ana Reis E Melo⁴, Margarida Tavares⁴

¹Centro Hospitalar de Leiria, Department Of Pediatrics, Leiria, Portugal, ²Centro Hospitalar e Universitário do Algarve, Department Of Pediatrics, Faro, Portugal, ³Centro Hospitalar Universitário de São João, Department Of Pediatrics, Porto, Portugal, ⁴Centro Hospitalar Universitário de São João, Pediatrics Infectious Diseases And Immunodeficiencies, Porto, Portugal

Title of Case: AN UNEXPECTED CASE OF INFECTIVE ENDOCARDITIS IN A TERCIARY HOSPITAL

Background: Infective endocarditis (IE) remains a complex and uncommon disease. The main risk factor for pediatric IE is underlying congenital heart defects. Established IE carries significant morbi-mortality risk but constant advancements in medicine have improved clinical outcomes.

Case Presentation Summary: A 9-year-old girl was admitted with asthenia, anorexia and recurrent headache for 3 months, reporting less analgesic benefit. She was well-appearing with a normal neurologic exam. As relevant medical history: moderate mitral insufficiency. Head CT-scan revealed an acute/sub-acute left frontal subcortical hemorrhage, with edema but no important mass effect. A presumptive diagnosis of bleeding cavernous hemangiomas was made. While hospitalized, she maintained headaches and developed low fever. Blood cultures were positive for *Streptococcus sanguis*. After further inquiry, the patient disclosed a dental instrumentation episode prior to the onset of complaints. Sequential blood cultures were positive to same microorganism. The initial transthoracic echocardiography (TTE) showed no vegetations but ceftriaxone+gentamicin were started (according to antimicrobial susceptibility testing), as Duke criteria were met for IE. Although there was an optimal response to antibiotics at first, after 2 days of therapy the patient clinically deteriorated with severe headaches, vomiting and diplopia. A head-MRI (fig. 1) was performed revealing intra-cerebral septic emboli, with worsening edema and a follow-up TTE demonstrated a mitral valve vegetation. Dexamethasone and acetazolamide were started with clinical improvement. The patient was discharged after a 6-week course of ceftriaxone (2-week of gentamicin), asymptomatic without valve replacement surgery.

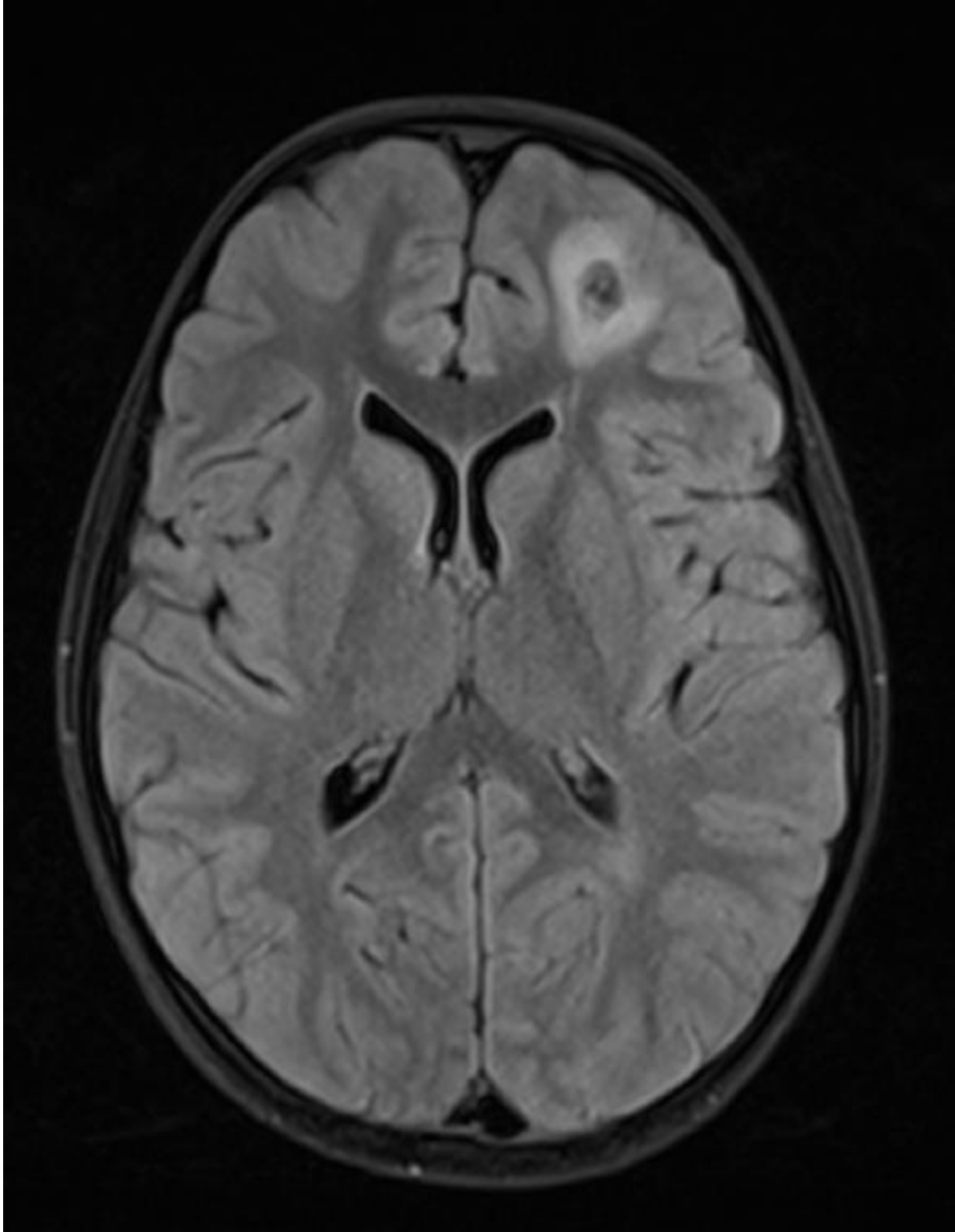

Learning Points/Discussion: IE remains a diagnostic challenge, with variable clinical presentation according to the causative microorganism, pre-existing cardiac disease and complications. Our case emphasizes the subacute form associated with *S. sanguis* infection and the importance of a multidisciplinary team in its management.

EP235 / #499

Topic: AS07. Non-respiratory infections / AS07.d. Sepsis, systemic and multi-organ infections

SEVERE PVL-MSSA INFECTION IN A CHILD: A CASE REPORT

E-Posters

E-POSTER VIEWING

Tânia C. Pessoa¹, Teresa L. Almeida², Filipa Prata³, Ana Mouzinho³, Leonor Boto⁴, Sara Pinto³

¹Centro Hospitalar Barreiro Montijo, Department Of Pediatrics, Barreiro, Portugal, ²Hospital do Espírito Santo de Évora, EPE, Évora, Department Of Pediatrics, Évora, Portugal, ³Hospital de Santa Maria, Centro Hospitalar Universitário Lisboa Norte, Pediatric Infectious Diseases And Immunodeficiencies Unit, Pediatric Department, Lisboa, Portugal, ⁴Hospital de Santa Maria, Centro Hospitalar Universitário Lisboa Norte, Pediatric Intensive Care Unit, Pediatric Department, Lisboa, Portugal

Title of Case: SEVERE PVL-MSSA INFECTION IN A CHILD: A CASE REPORT

Background: Staphylococcus aureus (SA) is a frequent agent of childhood infections. The presence of Pantone-Valentine leucocidin (PVL) has been associated with severe infections (pneumonia, osteomyelitis, arthritis), being also a prothrombotic factor.

Case Presentation Summary: A previously healthy 10-year-old girl, from Guinea-Bissau, living in the UK, became ill with fever, myalgias, and pain in the left ankle and shoulder. Minor trauma had happened two days before symptoms. She worsened within days, with unilateral ankle swelling, respiratory distress and progression to septic shock. She had pancytopenia and raised inflammatory markers; chest-xray showed bilateral diffuse infiltrates. She was admitted to PICU, requiring inotropic and respiratory support. Ceftriaxone, clindamycin and azithromycin were started; but later changed to flucloxacillin and gentamycin when a clindamycin-resistant methicillin-susceptible SA (MSSA) grew in blood, urine and respiratory secretions. Given the possibility of a PVL strain (later confirmed) linezolid and rifampicin were started. CT scan showed pulmonary thromboembolism and iliofemoral venous thrombosis; she was started on enoxaparin. She was on noradrenaline for 48h and ventilated for seven days. Her case was further complicated with multiple osteoarticular septic foci: tibiotarsal joint arthritis, fibula, humerus and spine osteomyelitis and lumbar paravertebral, psoas, and infrapsoas abscesses. Percutaneous drainages and orthopedic surgery were required and MSSA isolated in all samples. Three-weeks post-admission, she was transferred to the ward. She required physical rehabilitation and hyperbaric chamber sessions for two months; enoxaparin and antibiotics were kept for three months.

Learning Points/Discussion: This case highlights the importance of prompt recognition of PVL as a potent virulence factor in MSSA pediatric infections. Despite rare and not routinely investigated in Portugal, PVL-MSSA infection should always be considered in children with community-acquired SA and severe clinical presentations.

EP236 / #1324

Topic: AS07. Non-respiratory infections / AS07.d. Sepsis, systemic and multi-organ infections

SPLENIC ABSCESS IN A CHILD: A CASE REPORT

E-Posters

E-POSTER VIEWING

Dwiyanti Puspitasari¹, Dominicus Husada², Parwati Basuki², Leny Kartina², Ismoedijanto Moedjito²
¹Faculty of Medicine Airlangga University, Childhealth Department, Surabaya, Indonesia, ²Airlangga University / Dr Soetomo Hospital, Child Health, Surabaya, Indonesia

Title of Case: Splenic Abscess in A Child

Background: Splenic abscess is a rare infection in children. Its clinical signs are not-specific and may resembles other diseases, thus radiological investigations play an important role in establishing the diagnosis. Antibiotics and surgical/ percutaneous drainage of the abscess were the standard therapy. Here, we reported a rare case of splenic abscess in a child.

Case Presentation Summary: AS, a 16 years-old girl, referred with lumps on both necks for 2 weeks, painful and bigger. She had high fever 7 days, nausea, vomiting and look weak 2 weeks, difficult to eat/ drink, and melena. There were bilateral submandibular lymphadenopathy, multiple, mobile, tender and warm, causing decreased neck motion. The lung examination revealed empyema. From laboratory showed pancytopenia, increased CRP, acute kidney injury, hypo-albumin. Thorax CT-scan accidentally found hypo-dense lesion in spleen, confirmed by abdominal CT: a spleen abscess 7.8×6.3×8.4 cm at superior segment of spleen extend to left sub-hemidiaphragm and pleural cavity, with multiple intraabdominal lymphadenopathy. The blood and first empyema culture were sterile, but repeated empyema culture revealed *Enterococcus faecalis* sensitive to Fosfomycin, Ampicillin, Linezolid, Teicoplanin, and Vancomycin. She was treated with injection of ceftriaxone (8 days), cefoperazone-sulbactam (19 days), levofloxacin (14 days), Metronidazole (14 days) and ampicillin (14 days). A left thoracic pigtail drainage was placed, then because the evacuation of the empyema was still inadequate, a thoracic drain was installed. Clinical, laboratory and radiological parameters were improved after administration of antibiotics and insertion of a thoracic drain. The patient was discharged good condition from the hospital after 44 days of treatment.

Learning Points/Discussion: Spleen abscess has non specific signs and symptoms, thus radiological investigation is needed for diagnosis. Treatment with antibiotics and surgical intervention can give a good result.

EP237 / #930

Topic: AS07. Non-respiratory infections / AS07.d. Sepsis, systemic and multi-organ infections

PNEUMOCOCCAL INFECTIVE ENDOCARDITIS WITH CONCOMITANT MENINGITIS: A RARE ENTITY.

E-Posters

E-POSTER VIEWING

Sara Riera-Rubio¹, Gerard Martínez-Segura¹, Julià Gotzens¹, Carmina Guitart², Eneritz Velasco³, Carin Walter⁴, Iolanda Jordan⁵

¹Hospital Sant Joan de Déu, Paediatrics, Esplugues de Llobregat, Spain, ²Sant Joan de Déu Hospital, Paediatric Intensive Care Unit, Esplugues de Llobregat, Spain, ³Hospital Sant Joan de Déu, Infectious Disease, Esplugues de Llobregat, Spain, ⁴Hospital Sant Joan de Déu, Paediatric Cardiology, Esplugues de Llobregat, Spain, ⁵Hospital Sant Joan de Déu, Intensive Care Unit, Esplugues, Spain

Title of Case: PNEUMOCOCCAL INFECTIVE ENDOCARDITIS WITH CONCOMITANT MENINGITIS: A RARE ENTITY.

Background: Pneumococcus infrequently causes infective endocarditis (IE). Association with concomitant pneumonia and spread to the central nervous system are common. Its course can be aggressive and almost half of patients need surgery.

Case Presentation Summary: A two-year-old boy, previously healthy and fully-immunized was admitted to the hospital after 9 days of high-grade fever. He was ill-appearing and meningeal signs were negative. Blood test showed 15.000 leucocytes/mm³ (70% neutrophils) and altered C-reactive protein (210mg/L) and procalcitonin (48.2ng/mL); chest X-ray was normal. Blood and urine cultures were obtained and intravenous ceftriaxone was started. Fever subsided 24 hours after admission but he presented irritability, persistent tachycardia, progressive respiratory distress, and a heart murmur not previously detected. Transthoracic ultrasound showed large vegetation (17x7mm) in the mitral valve with severe mitral insufficiency and acute heart failure. Blood culture was positive for *Streptococcus pneumoniae* (serotype 15 BC). An Osler's node and subungual haemorrhages were found. Non-invasive ventilation, vasoactive support with milrinone and diuretics were initiated. Vancomycin was added to the antibiotic regimen for 5 days until penicillin-susceptibility was confirmed. Blood culture at 48 hours of admission was negative. CSF analysis was altered (54 leucocytes/mm³ [15% neutrophils], proteins 39 mg/dL, glucose 54 mg/dL), *S. pneumoniae* polymerase-chain-reaction (PCR) was positive and culture resulted negative. Cerebral RM and ocular fundus were normal. The vegetation was surgically removed with an uncomplicated postoperative course and *S. pneumoniae* PCR in the surgical sample was positive. The patient received 4 weeks of intravenous ceftriaxone and 2 additional weeks of oral antibiotic. Immunological disorders were excluded.

Learning Points/Discussion: Pneumococcal occult bacteraemia is one of the major causes of prolonged febrile syndrome. IE is a rare entity but should be considered.

EP238 / #639

Topic: AS07. Non-respiratory infections / AS07.d. Sepsis, systemic and multi-organ infections

CHARACTERISTICS OF MENINGOCOCCAL SEPSIS IN CHILDREN

E-Posters

E-POSTER VIEWING

Kate Serhiyenka

Belarussian state medical university, Children Infection Diseases, Minsk, Belarus

Backgrounds: The aim of our work was the clinical features of meningococcal sepsis in children.

Methods: In order to study the clinical features of meningococcal sepsis, an analysis of 123 medical records of patients who were treated at the Municipal Children's Infectious Diseases Clinical Hospital in Minsk from 2009 to 2020 was carried out. To determine the criteria for the unfavorable course of meningococcal sepsis, all patients were divided into 2 groups: group 1 - patients (n=58, 47%) with septic shock (SS); Group 2 – patients without SS (n=65, 53%).

Results: All children at admission to the hospital had an increase in body temperature, and in 99% to febrile figures. The median fever was 39.250C (38.8-39.90C) in group 1 and 39.00C (39.0-39.80C) in group 2 ($p>0.05$), duration - 4 days (3-11) and 2 days (2-3), respectively ($p<0.0005$), in 3 patients of group 1 fever persisted for a long time (more than 1 month). Along with fever, a rash appeared in 100% of cases. In most cases, the rash appeared already on the first day of the onset of the disease (88% and 87.7%, respectively). Analyzing the nature of rashes, it should be noted that hemorrhagic elements were observed in almost all patients of group 1 (98.3%), which is significantly more than in group 2 (83.1%), $p=0.006$, and the widespread (throughout the body) character was observed almost equally in both groups (79.3% and 83.1%, respectively). In patients with meningococcal sepsis of group 1, significantly more frequent formation of necrosis on the skin was found (29.5% vs. 6.2%, $p=0.0007$).

Conclusions/Learning Points: In all patients with meningococcal sepsis with septic shock, the main clinical manifestations of the disease were: an increase in body temperature to febrile figures and rash.

EP239 / #641

Topic: AS07. Non-respiratory infections / AS07.d. Sepsis, systemic and multi-organ infections

THE SPECTRUM OF PATHOGENS OF SEPSIS IN CHILDREN

E-Posters

E-POSTER VIEWING

Kate Serhiyenka

Belarussian state medical university, Children Infection Diseases, Minsk, Belarus

Backgrounds: Sepsis can be caused by bacterial, fungal, viral and parasitic pathogens. Bacteremia is not mandatory for the diagnosis of sepsis, and only 30-50% of patients with septic shock have a positive seeding result.

Methods: The purpose of our work is to study the etiological structure of sepsis in children. The analysis of 264 medical records of inpatient patients aged from 1 month to 18 years who were treated at the Municipal Children's Infectious Diseases Clinical Hospital in Minsk from 2009 to 2020 was carried out. According to the age composition, the patients were distributed as follows: 91 patients (34.5%) under 1 year old, 100 children (37.8%) 1-3 years old, 25 children (9.5%) 4-6 years old and 48 patients (18.2%) over 7 years old.

Results: In 137 patients with sepsis (52%), the disease was complicated by the development of septic shock, and in 42 (15.9%) it had a fatal outcome. In 26.5% of cases, a severe pathological condition developed in children with an unfavorable background (PID, CHD, cerebral palsy, Hirschsprung's disease, MVPR, cryptogenic cirrhosis, etc.). The etiology of sepsis was established in 69.5% of cases. Unfortunately, the etiology of sepsis has not been confirmed in 43 patients (21.5%). The etiological structure of sepsis was dominated by gram-negative bacteria (40.9%), gram-positive microorganisms accounted for 12.9%, fungi – 0.4% and mixed flora - 5.3%. The spectrum of gram-negative pathogens is as follows: *N. meningitidis* 77.8%, *Ps. aeruginosa* 3.7%, *H. influenzae* 5.6%, *Ac. baumannii* 3.7%, *Kl. pneumoniae* 5.6% and *E. coli* 1.8%, *Achromobacter xylosoxidans* and *S. enteritidis* - 0.9% each. Among gram-positive bacteria, streptococci accounted for 64.9%, staphylococci - 35.1%.

Conclusions/Learning Points: The structure of sepsis is dominated by gram-negative bacteria.-

EP240 / #1483

Topic: AS07. Non-respiratory infections / AS07.d. Sepsis, systemic and multi-organ infections

KLEBSIELLA OXYTOCA SEPSIS WITH PROBABLE GASTROINTESTINAL FOCUS.

E-Posters

E-POSTER VIEWING

Irene Serrano Carreño, Alba Molina Ureba, Noelia Berciano Jiménez, Mariano Marin Patón, Rosa Rodríguez González, Sofia Haidour Salido, Laura García Matamoros, Marcos Rodríguez Torres
Hospital Universitario Virgen Macarena, Pediatría, Sevilla, Spain

Title of Case: KLEBSIELLA OXYTOCA SEPSIS WITH PROBABLE GASTROINTESTINAL FOCUS.

Background: Adenovirus infections are a common cause of acute gastroenteritis. The association between gastroenteritis and a secondary bacteremia by enteric gram-negative rods as Escherichia Coli, Klebsiella Pneumoniae and Enterobacter cloacae has been described in several studies. Nonetheless, the link with Klebsiella Oxytoca has not been reported yet. The aim of this case study is to report the possible connection between adenovirus gastroenteritis and Klebsiella Oxytoca bacteremia.

Case Presentation Summary: A 9-month old boy came to the hospital with acute dehydration, 48 hours of fever, loose and bloody stools, vomits, weakness and hyporexia. The blood test values were regular. Adenovirus and Campylobacter jejuni sensitive to azithromycin has been found in the stool culture. 24 hours after starting the antibiotic treatment, the patient began with high fever, hemodynamic and respiratory instability, with an increase of acute phase reactants (CRP 116mg/L, D-dimer 5862 ng/mL). Suspecting a sepsis, intravenous cefotaxime and gentamicin has been added. Following that, the patient evolved favourably, staying afebrile, with normalisation of the blood test and the respiratory work. In the blood culture was founded Klebsiella Oxytoca. After 10 days of hospitalization, and with the end of cefotaxime, the infant has been discharged.

Learning Points/Discussion: - Klebsiella Oxytoca is an enteric gram-negative rod commensal of the human intestine. It's speculated that the intestinal flora goes through the injured bowel by viral infections. - When persistent fever and deterioration appear in an infant with gastroenteritis, we should think about a bacteremia; hence, obtaining a blood culture and starting empirical antibiotic therapy. - The possible association discovered between the Klebsiella Oxytoca sepsis and the gastroenteritis due to adenovirus infection must be considered in the future studies of the common clinical practice.

EP241 / #331

Topic: AS07. Non-respiratory infections / AS07.d. Sepsis, systemic and multi-organ infections

PEDIATRIC MEDITERRANEAN SPOTTED FEVER (MSF)

E-Posters

E-POSTER VIEWING

Elda Skenderi

University Hospital Center "Mother Teresa", Tirana, Albania, Pediatrics, Tirana, Albania

Title of Case: Pediatric Mediterranean Spotted Fever (MSF)

Background: Mediterranean spotted fever (MSF), is caused by *Rickettsia conorii*, an organism that is endemic in the Mediterranean region. *R. conorii* is transmitted by the dog tick *Rhipicephalus sanguineus*. The major clinical features of MSF are: fever, exanthema, eschar at site of tick bite. The exanthema is typically maculopapular and involves the entire body including the palms and soles.

Case Presentation Summary: A 4-years old boy presented with a 7-days history of high fever, vomitus and abdominal pain. On physical examination he appeared ill with a generalized maculopapular rash including palms and soles, an eschar was observed on the posterior part of the neck at the hairline border. No neurologic signs were observed, abdomen was soft and palpable. Blood count revealed WBC 13,000 cells/mm³, RBC 4,670,000cells/mm³, hemoglobin 11.5g/dL, PLT 331,000cells/mm³, slightly increased C reactive protein, normal hepatic and renal function, negative blood and urine cultures, and a WEIL-FELIX reaction of 1:80. The diagnosis of MSF was concluded, Azithromycin was initiated. The fever abated and rash faded in 2 days.

Learning Points/Discussion: MSF has increased worldwide due to increased travel to endemic areas. Although it is usually a mild disease severe complications including neurologic involvement does occur. Diagnosis is commonly made on the basis of clinical findings as there is no test that can reliably confirm MSF. A high degree of clinical suspicion is required, MSF should be considered in all febrile patients living or returning from endemic areas.

EP242 / #1182

Topic: AS07. Non-respiratory infections / AS07.d. Sepsis, systemic and multi-organ infections

NARRATIVE OF PUBLISHED EXPERIENCE OF A DIVERSE SPECTRUM OF INVASIVE MENINGOCOCCAL DISEASE (IMD) IN PAEDIATRIC AND ADOLESCENT PATIENTS

E-Posters

E-POSTER VIEWING

Woo-Yun Sohn¹, Rafik Bekkat-Berkani¹, Athena Cavounidis², Shravani Bobde¹

¹GlaxoSmithKline, N/a, Rockville, United States of America, ²GlaxoSmithKline, N/a, Wavre, Belgium

Backgrounds: IMD due to *Neisseria meningitidis* infection has various clinical manifestations, ranging from transient fever and bacteraemia to fulminant disease and death within hours of onset. The potential for a range of complications means that treatment beyond antibiotic therapy may be diverse. We reviewed case reports of IMD in paediatric/adolescent patients describing clinical manifestations, treatments and outcomes.

Methods: A literature search (PubMed) using the terms 'case report', '*Neisseria meningitidis*', 'invasive meningococcal disease' and 'infant', 'children', 'paediatric' or 'adolescent' published between 01/01/2011 and 11/08/2021 was conducted, and results reviewed.

Results: A total of 105 cases, including 17 with fatal outcomes, were described across 75 reports. Patients included 4 neonates (aged 0–28 days), 18 infants (≤ 1 year), 33 children (≤ 12 years) and 38 adolescents (where age specified). Serogroup was provided for 69 patients (serogroup B [n=18]; C [n=17]; W [n=26]; Y [n=7, including 2 expressing W-antigenic specificities]; 29E [n=1]). Reports described meningococcaemia with or without meningitis. Complications included cerebral abscess, subdural empyema, pericarditis, myocarditis, petrified myocardium, pneumonia, epiglottitis, splenic cyst (in a partially [MenC] vaccinated child), adrenal insufficiency, peritonitis, acute abdominal pain, purpura fulminans, Kawasaki disease, concurrent herpes, and conjunctivitis. Chronic meningococcaemia was reported in four patients, including one who experienced 4 episodes of associated rash and malaise. Several patients had primary *N. meningitidis* septic arthritis (with or without myositis), including one fully vaccinated individual with serogroup W disease. Empirical and definitive antibiotic treatment included a third-generation cephalosporin (ceftriaxone or cefotaxime) sometimes with other agents or neurosurgical intervention. Five reports of antibiotic-resistant IMD were identified.

Conclusions/Learning Points: IMD presentation in paediatric/adolescent patients varies, with a diverse spectrum of complications, highlighting the challenges associated with identifying and treating *Neisseria* infections.

EP243 / #1382

Topic: AS07. Non-respiratory infections / AS07.d. Sepsis, systemic and multi-organ infections

INVASIVE E.COLI K1 DISEASE IN A FOUR-MONTH FEMALE INFANT

E-Posters

E-POSTER VIEWING

Sofia Taximi¹, Georgia Dimitriou¹, Sofirela Berdalli¹, Vassiliki Mougou¹, Alexia Palioura¹, Ismini Anagnostaki², Katerina Koumparelou², Anastasia Konidari², Kyriaki Tsotra², Afroditi Sakellaropoulou², Nikoleta Mastrantonaki², Evangelia Kyritsa², Stella Mouskou³, Georgios Markogiannakis⁴, Christina Karastathi¹

¹Paidon Aglaia Kyriakou Children's Hospital, Beta Paediatric Department, Athens, Greece, ²Children's Hospital P&A Kyriakou, Paediatrics, Athens, Greece, ³"P& A Kyriakou" Children's Hospital, Department Of Neurology, Athens, Greece, ⁴Children's Hospital P&A Kyriakou, Neurosurgery, Athens, Greece

Title of Case: INVASIVE E.COLI K1 DISEASE IN A FOUR-MONTH FEMALE INFANT

Background: Pathogenic E.coli is a major cause of morbidity and mortality, mainly responsible for neonatal meningitis. More than half survivors present serious neurological disorders (seizures, hydrocephalus, developmental disabilities). Among the different types of E coli virulent capsular antigens described, at almost eighty percent of neonatal meningitis cases, K1 antigen is detected. We report a case of a four-month old girl with invasive E coli K1 disease with a remarkable outcome.

Case Presentation Summary: A four-month female infant with a medical history of NICU hospitalisation with a seven-day antibiotic course for suspected sepsis, presented at the ER with high fever, lethargy, starting fourteen hours prior to admission. A full bacterial workup was performed (blood culture, lumbar puncture & urine culture) which came positive for E Coli K1+ with AST profile resistant only at quinolones. A third generation cephalosporin was instated. Due to persistent fever, brain imaging was performed, revealing subdural bilateral abscesses. Aminoglycoside was added to initial treatment with no clinical effect. An external ventricular drain was placed at the tenth day of hospitalisation with a favourable evolution. Two years later, the patient has no neurological sequelae. Her immunological workup was normal.

Learning Points/Discussion: The vertical mother-newborn colonisation of K1 E Coli strains at birth is still controversial but, if occurred, there is progressive development of specific antibodies of the child. Recent studies using functional genomics techniques have identified additional E. coli K1 factors that contribute to the development of bacteremia and human brain microvascular endothelial cells binding and invasion. Further studies need to be performed, especially in countries with high MDR prevalence, to determine if maternal faecal screening is beneficial for prevention of the invasive E coli K1 infections.

EP244 / #1888

Topic: AS07. Non-respiratory infections / AS07.d. Sepsis, systemic and multi-organ infections

ADOLESCENT WITH MULTIFOCAL STAPHYLOCOCCAL INVASIVE DISEASE AND MULTIPLE SEPTIC PULMONARY EMBOLI

E-Posters

E-POSTER VIEWING

Konstantinos Zachos, Polyzwis Velentzas, Tatiana Alexandrova, Kosmas Kotsonis
AGIA SOPHIA CHILDRENS HOSPITAL, First Pediatric Department, ATHENS, Greece

Title of Case: ADOLESCENT WITH MULTIFOCAL STAPHYLOCOCCAL INVASIVE DISEASE AND MULTIPLE SEPTIC PULMONARY EMBOLI

Background: Although usually responsible for mild skin and soft tissue infections, high virulent strains of *St. aureus* can cause complex, multi-organ and treatment resistant clinical courses.

Case Presentation Summary: A male adolescent was referred after long hospitalization in Pediatric Clinics and PICU. He presented 17 days ago with fever, rapidly evolving right arm cellulitis, movement limitation and respiratory distress. Initial workout revealed leukocytosis and high inflammation markers. Chest x-ray showed diffuse infiltrates and Doppler displayed extensive arm DVT. MRI revealed right elbow's septic arthritis, osteomyelitis and pyomyositis. Blood culture was positive for MSSA (Clindamycin resistant). The patient was admitted to PICU and received multiple antibiotic combinations and LMWH. Although his arm's clinical appearance improved after double joint aspiration, he remained bacteremic for 7 days and fever persisted. His respiratory status gradually deteriorated and by the time of referral, large bilateral parapneumonic effusions developed. Toxin-mediated disease was speculated and he initially received both bacteriostatic and bactericidal antibiotics. CTA thorax confirmed our suspicion, indicating multiple septic emboli. Chests tubes were placed, and fever rapidly resolved. Respiratory status slowly improved and laboratory parameters gradually normalized. Since arm movement also improved gradually, orthopedic intervention was not required. He was discharged after 8 weeks of intravenous antibiotics and received antimicrobials for a total of 3 months and anticoagulants (LMWH) for 6 months. Follow-up arm's MRI and Doppler were normal. Finally, extensive work up, ruled out immunodeficiency and prothrombotic

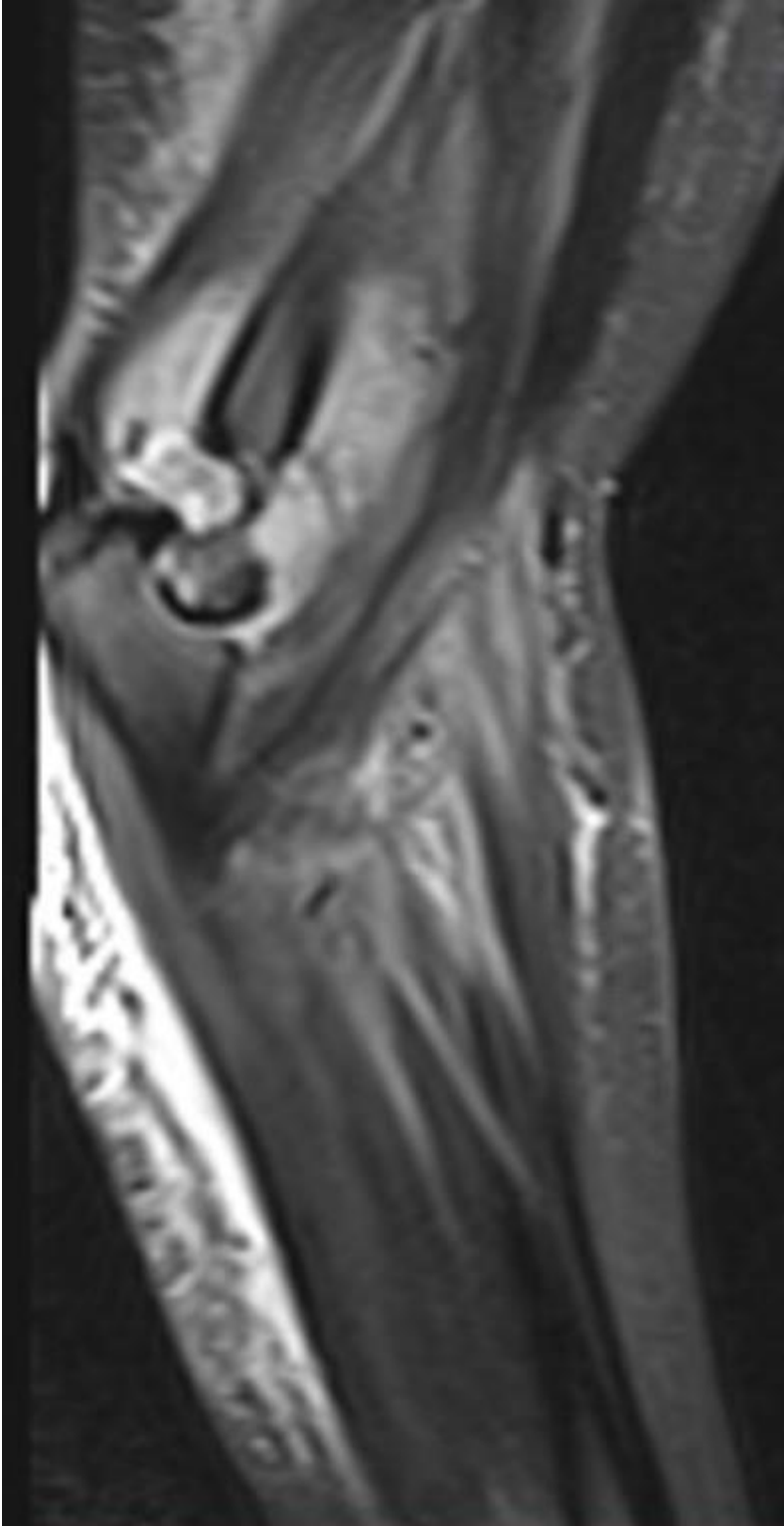

state.

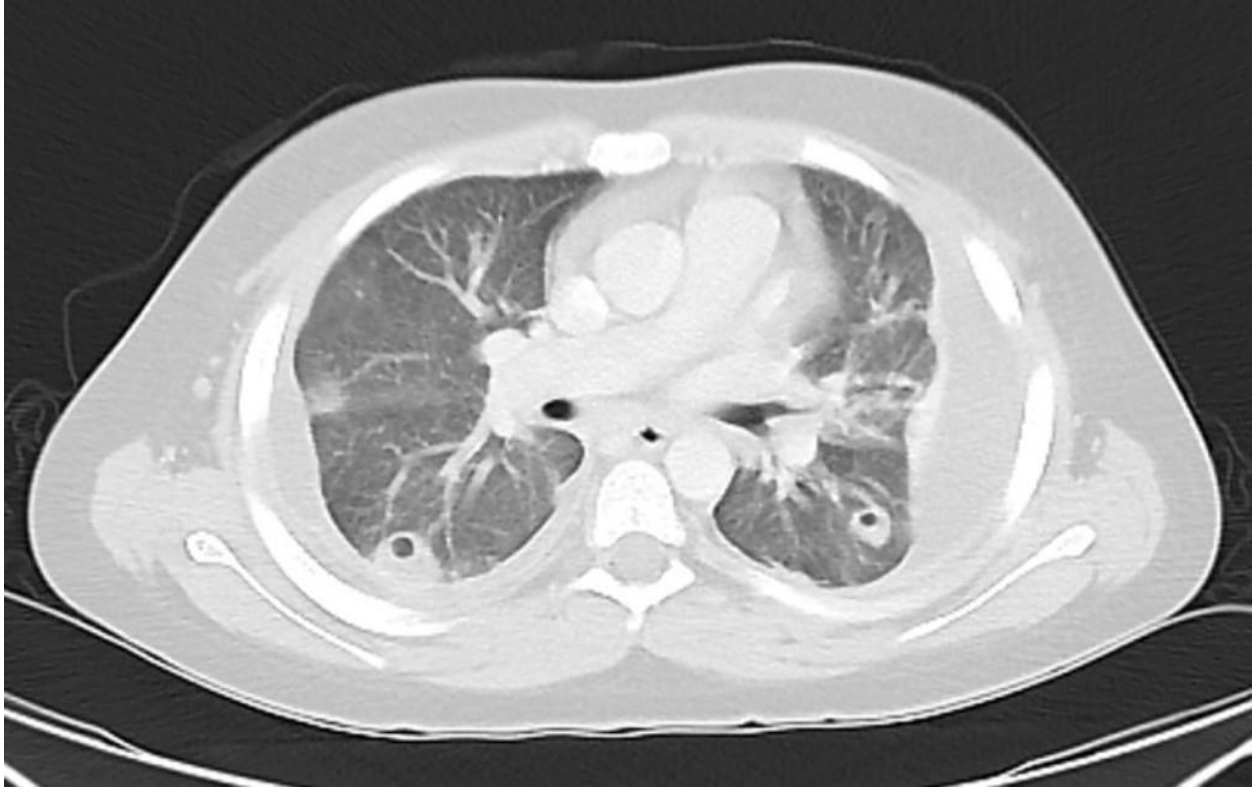

Learning Points/Discussion: Despite proper antimicrobial therapy, MSSA strains can cause severe multifocal invasive disease with prolonged bacteremia and morbidity. High index of suspicion is required for the co-existence of osteoarticular infection, DVT and septic pulmonary thrombophlebitis.

EP245 / #1414

Topic: AS07. Non-respiratory infections / AS07.e. Skeletal infections

MENINGOCOCCAL POLYARTHRITIS: AN INFREQUENT PRESENTATION

E-Posters

E-POSTER VIEWING

Dara Boza Medina, María Zamora Hernández, Pablo Caballero Belloch
Hospital Doctor José Molina Orosa, Pediatrics, Arrecife, Spain

Title of Case: MENINGOCOCCAL POLYARTHRITIS: AN INFREQUENT PRESENTATION

Background: Arthritis is an uncommon manifestation of meningococcal infection. It can occur as acute septic arthritis during acute meningococcemia, related to a chronic infection or as a postinfectious immune complex-mediated arthritis.

Case Presentation Summary: A 14-year-old Caucasian boy presented with fever, acute pharyngotonsillitis, pain and inflammation in both ankles and left knee in the previous 48 hours, with no neurological abnormalities. He had taken amoxicillin-clavulanic the day before. One week earlier he had presented acute gastroenteritis. Relevant laboratory results were hemoglobin 12 g/dL, leukocytes 19900/ μ L (neutrophils 67.5%), C reactive protein 45 mg/dL, procalcitonin 0.35 ng/mL, ferritin 301 ng/mL and erythrocyte sedimentation rate 120 mm/h. Joints fluid showed turbid liquid, leukocytes 61600/mL (polymorphonuclears 95%), glucose < 3 mg/dL, and no bacteria were detected in gram stain. Septic polyarthritis was suspected, so vancomycin, rifampicin and clindamycin were prescribed. He had initial clinical improvement after arthroscopic drainage and irrigation of affected joints. However, at day 3 he still had fever and his right knee became affected, so cefotaxime was added. Blood culture and joint liquids were negative, but PCR for *Neisseria meningitidis* was positive in joint fluids. Autoimmune tests showed HLA-B27 positive. Evolution and results suggested post-meningococcal immune complex-mediated arthritis, so cefotaxime was continued, and steroid and anti-inflammatory therapy was added. Two days later, minimal pleural effusion and pericarditis appeared. Despite this, his symptoms resolved progressively within one month.

Learning Points/Discussion: Our conclusion is that patient suffered of post-meningococcal immune complex-polyarthritis. The management of this case was complicated due to the low incidence of the disease and because of an early antibiotic treatment, which could have masked the correct diagnosis. These two facts led to delay the diagnosis and an appropriate treatment.

EP246 / #1164

Topic: AS07. Non-respiratory infections / AS07.e. Skeletal infections

THE CURIOUS CASE OF CHRONIC OSTEOMYELITIS OF THE RADIUS

E-Posters

E-POSTER VIEWING

David Bui¹, George Konidaris², Christopher Spelman¹

¹Sydney Children's Hospital, Orthopaedic Surgery, Sydney, Australia, ²Bankstown Hospital, Orthopaedic Surgery, Sydney, Australia

Title of Case: THE CURIOUS CASE OF CHRONIC OSTEOMYELITIS OF THE RADIUS IN A CHILD

Background: Chronic osteomyelitis is uncommon in developed countries. However, rates have been reported to be increasing worldwide. These infections can be devastating in children, who are still developing and may require multidisciplinary team involvement.

Case Presentation Summary: We present the curious case of a 10 year old boy born in Australia who presented to a district hospital with worsening pain 3 months after an elbow injury. There was no history of skin breach or previous infection that would have seeded to the bone. Examination revealed a well afebrile comfortable child with diffuse swelling of the radius, mild tenderness and pain on maximal pronation. Imaging demonstrated frank chronic osteomyelitis of the radius with sequestrum, involucrum and multiple sinuses. After multidisciplinary discussion and referral to a tertiary paediatric hospital, surgical management with low energy corticotomy, curettage, debridement, washout and intraosseous drains was performed. Intra-operative samples grew Methicillin-Resistant Staphylococcus Aureus, which was sensitive to Clindamycin.

Learning Points/Discussion: This case serves as a reminder to keep chronic osteomyelitis on the differential for chronic arm pain, and highlights the potential insidious but destructive nature of these infections, particularly in children, who have the potential for growth arrest and angular deformity with physeal involvement, and those with MRSA.

EP247 / #1472

Topic: AS07. Non-respiratory infections / AS07.e. Skeletal infections

ADEQUACY OF ANTIBIOTIC THERAPY IN PEDIATRIC OSTEOARTICULAR INFECTIONS. A RETROSPECTIVE STUDY.

E-Posters

E-POSTER VIEWING

Laura Calle-Miguel¹, Belen Moreno Pavon², Alejandra Méndez Sánchez³, Carlos Pérez Méndez³, Elisa García-García⁴, Sheila Martín Pino¹, Luis Vega López¹, Virginia Courel Del Río¹, Sergio Álvarez Álvarez^{1,5}, María Fernández Miaja¹

¹HOSPITAL UNIVERSITARIO CENTRAL DE ASTURIAS, Pediatrics, Oviedo, Spain, ²CS CONTRUECES, Pediatrics, Gijón, Spain, ³Hospital Universitario de Cabueñes, Pediatrics, Gijón, Spain, ⁴CS LAVIADA, Pediatrics, Gijón, Spain, ⁵HOSPITAL UNIVERSITARIO CENTRAL DE ASTURIAS, Traumatology And Orthopedics, Oviedo, Spain

Backgrounds: Adequate antibiotic treatment, in addition to an early diagnosis, is essential for a recovery without sequelae. The aim of this study was to assess the compliance to the current recommendations in osteoarticular infections (OAI).

Methods: A retrospective study included patients up to 14 years old admitted with OAI in the two main hospitals of Asturias (Northern Spain). Data were collected from electronic medical records. Adequacy of empirical and directed treatment and its duration was compared to the guidelines of the Spanish Society of Pediatric Infectious Diseases. A comparative analysis between two periods (2014-2017 vs 2018-2021) and the hospitals was done.

Results: A total of 63 cases were registered [61.9% males; median age 7.5 years old (IQR 2.5-10.9)], distributed in 33 (52.4%) osteomyelitis, 27 (42.9%), septic arthritis and 3 (4.8%) osteoarthritis. A microbiological confirmation was obtained in 52.4% of cases. The median time of admission was 10 days (IQR 6-15) and of antibiotic therapy 28 days (IQR 22.3-35.8). Twenty-two patients underwent surgery (14 arthrotomies) and 10 required arthrocentesis. Twenty-two (34.9%) infections were complicated or produced by atypical microorganisms. In the remaining cases, treatment was inadequate in 51.2%, being the main causes a prolonged antibiotherapy (30%) and the inaccurate choice of intravenous directed treatment (26.3%). A decrease in days of admission ($p=0.037$) and days of intravenous treatment ($p=0.040$) was noticed over the last years. The rate of inadequacy was significantly different between both hospitals (69.6% vs 27.8%; $p=0.008$)

Conclusions/Learning Points: Adequate antibiotic therapy was only provided in less than half of the children with OAI, showing the importance of antibiotic stewardship programmes in order to improve the compliance to the current recommendations.

EP248 / #1549

Topic: AS07. Non-respiratory infections / AS07.e. Skeletal infections

PEDIATRIC RAT BITE FEVER. A CASE REPORT

E-Posters

E-POSTER VIEWING

Maria Castillo, Sonia Mathew, Guyu Li, Samanta Catueño

Texas A&M School of Medicine, Post Graduate Education, Driscoll Children's Hospital, Pediatrics, Corpus Christi, United States of America

Title of Case: PEDIATRIC RAT BITE FEVER. A CASE REPORT

Background: The risk of Rat Bite Fever due to *S. moniliformis* after a rat bite is reported to be 10 percent, and an estimated 20,000 rat bites occur in the United States each year. Historically, over 50 percent of reported cases occurred in children, and Rat Bite Fever was most likely to be seen in those living in poverty. Symptoms start abruptly with fever, myalgias, migratory arthralgias, vomiting, pharyngitis, and headache. By the time symptoms develop due to a bite or scratch, the wound has usually resolved and there is no regional adenopathy. Many cases go undiagnosed since these bacteria are difficult to identify and are likely to respond to empiric antibiotic therapy

Case Presentation Summary: Our case describes a 5-year-old male who presented to the hospital with right lower extremity pain, inability to bear weight on the right leg, nocturnal fevers, and slight weight loss. Workup for septic arthritis, osteomyelitis, and leukemia were negative. Patient was discharged due to improving clinical symptoms but was readmitted when blood cultures returned positive for *Streptococcus moliniformis*. Patient was treated with penicillin G with complete resolution of symptoms and later discharged home.

Learning Points/Discussion: Initial work up for sepsis revealed positive cultures for *Streptococcus moliniformis*, after readmission, further clinical interrogation was done, and mother stated that patient was bit by pet rat, but no antibiotics were given when taken to Pediatrician. This case highlights the importance of including rat-bite fever as a differential diagnosis and the importance of interrogating home conditions and pets during clinical assessment when facing challenging cases of unexplained causes of fever and septic arthritis.

EP249 / #1181

Topic: AS07. Non-respiratory infections / AS07.e. Skeletal infections

LINE SURVIVAL TIMES AND COMPLICATIONS IN A P-OPAT (PAEDIATRIC OUTPATIENT PARENTERAL ANTIBIOTIC THERAPY) SERVICE

E-Posters

E-POSTER VIEWING

Joanne Cooper¹, Antoinette Brown², Katja Doerholt²

¹St George's University of London, Imbe, London, United Kingdom, ²St George's Hospital, Paediatric Infectious Diseases, London, United Kingdom

Backgrounds: Peripherally inserted central catheters (PICCs) are often recommended for children requiring prolonged intravenous antimicrobial therapy under pOPAT follow up. For children requiring less than 14 days antimicrobial therapy, midlines or peripheral intravenous catheters (PIV) are inserted. In view of recent introduction of midline use into our service, our aim is to review overall line use and safety in our pOPAT service.

Methods: Data were retrospectively collected of lines used in children (n=32) in a tertiary hospital pOPAT service from 05/2020-04/2021. Demographic and line outcome data are described.

Results: Median age was 23 months (IQR 81 days, 12.5 years). Age: 8 patients <3 months, 8 patients 3m-2 years; 16 patients >2y. 14 were female. Skeletal infections, bacteraemia, soft tissue infection were the 3 most common indications for POPAT with ceftriaxone prescribed in 31/32 (97%) children. Total lines inserted 27 PIVs; 35 midlines.

>50% of all lines in age <3m (n=14) and PIVs in age >2y (n=7) were removed due to line related factors; leaking and occlusion were common problems. Local signs of infection were seen in 2 midlines, no line-related bacteraemia was recorded.

Overall survival time of midlines with a median of 6 days (IQR4,12) was significantly longer than PIVs with 2.4 days (IQR1-3).

Conclusions/Learning Points: Line-related factors often lead to removal and re-insertion of lines in p-OPAT - this applies to PIVs and midlines. Lines in patients aged <3m are particularly vulnerable. Line-related infections and other serious complications are rare. Midlines are beneficial and safe for children due to significantly longer survival time compared with PIVs.

EP250 / #754

Topic: AS07. Non-respiratory infections / AS07.e. Skeletal infections

A RARE CAUSE OF OSTEOMYELITIS IN AN 10-MONTH-OLD CHILD

E-Posters

E-POSTER VIEWING

Gabrielle De Crombrugghe^{1,2}, Catherine Adler³

¹Molecular Bacteriology Laboratory, Université Libre de Bruxelles, Bacteriology, Brussels, Belgium, ²Academic Children Hospital Queen Fabiola, Université Libre de Bruxelles, Pediatrics, Brussels, Belgium, ³Academic Saint Pierre Hospital, Pediatrics, Brussels, Belgium

Title of Case: A RARE CAUSE OF OSTEOMYELITIS IN AN 10-MONTH-OLD CHILD

Background: Microbiological identification in hematogenous osteomyelitis in children remains challenging with no pathogen isolated in up to one-half of cases. Gram-positive bacteria, particularly *Staphylococcus aureus* are the main cause of hematogenous osteomyelitis in children. Among Gram-negative bacteria, European studies highlighted importance of *Kingella kingae*, suggesting that it is the first pathogen responsible of osteoarticular infections in children between 6 and 36 months. Other germs are very rarely found in healthy children.

Case Presentation Summary: A 10-month-old boy with no previous medical history presented to a hospital in Brussels with a 72-hour history of fever, red and swollen left knee. He had an elevated C-reactive protein (77mg/L), increased white blood cells (15500/ μ L) and erythrocyte sedimentation rate (111mm/h). Knee ultrasound showed small joint effusion and 1st generation cephalosporin was started intravenous without prior fluid puncture. The clinical evolution being unfavorable, antibiotherapy was extended to a 3rd generation cephalosporin and joint puncture was performed on the 7th day of hospitalization revealing a Nontyphoidal (NT) *Salmonella*. MRI revealed an abscessed collection on the distal femur. After surgical drainage and prolonged antibiotherapy, follow-up showed complete recovery. Hemoglobin electrophoresis and immune evaluation were normal.



Learning Points/Discussion: Salmonella species is a rare cause of osteomyelitis, known to mostly affect patients with sickle cell disease or immune deficiency including defect in IL-12/23-IFN- γ axis. These are associated with a high complication rate (36%) compared with 5% for classical germ osteomyelitis. Empirical antibiotic therapy targeting gram-positive pathogens is recommended in hematogenous osteomyelitis in children. This case reminds to review therapeutic strategy in case of suboptimal evolution

and illustrates the importance of pathogen identification in osteoarticular infections, which relies on close collaboration between pediatrician, orthopedist and radiologist.

EP251 / #1082

Topic: AS07. Non-respiratory infections / AS07.e. Skeletal infections

ACUTE OSTEOARTICULAR INFECTIONS: 14-YEAR STUDY IN A REGIONAL PORTUGUESE HOSPITAL

E-Posters

E-POSTER VIEWING

Sandra Catarina Ferraz, Inês Correia Magalhães, André Costa Azevedo, Daniela Araújo, Pedro Marinho, Cláudia Lemos, Mariana Costa
Unidade Local de Saúde do Alto Minho, Pediatrics, Viana do Castelo, Portugal

Backgrounds: Osteomyelitis (OM) and septic arthritis (SA) are infections of the bone and the joint, respectively. Both are usually caused by bacteria and in children the most common origin is hematogenic.

Methods: A 14 year (January/2008 to December/2021) retrospective study was conducted regarding patients diagnosed with osteoarticular infections (OAI) admitted in the neonatal and pediatric unit of a secondary hospital. Demographic, clinical and therapeutic features were accessed.

Results: A total of 31 OAI were found, 14 OM and 17 SA. The median age of diagnosis was 9.2 years in OM and 7.5 years in SA.

Among OM cases, 64% occurred in lower limbs and 14% were spondylodiscitis. 93% presented with pain, 79% with fever and 29% had local inflammatory signs. MRI was essential to the diagnosis of 86% OM. Regarding AS, 41% were sacroiliitis, 29% occur in the knee and 24% in the hip. All presented with pain or limitation of the movement, 35% with fever and 24% with local inflammatory signs. Ultrasound made the imagiological diagnosis in 53% of the cases.

The median time of hospitalization was 19 days in OM and 21 days in SA. Intravenous antibiotherapy was performed during a median of 17 days in OM and 19 days in SA. The most frequently identified agent was *Staphylococcus aureus* (16 cases, 52%), only 1 MRSA. There was no identification of the agent in 11 cases. Invasive procedures were conducted in 55% of the cases.

Conclusions/Learning Points: OAI are rare, but prompt diagnosis and treatment are essential to prevent complications and long-term disability. Pain was the most frequent presentation symptom. The knowledge of local antibiotic resistance prevalence is important to adequate empirical antibiotherapy.

EP252 / #1424

Topic: AS07. Non-respiratory infections / AS07.e. Skeletal infections

MORAXELLA INFECTION IN PAEDIATRICS: NOT EVERYTHING IS A COLD.

E-Posters

E-POSTER VIEWING

Claudia García Barrionuevo, Adrián Muñoz-Cruzado Rosete, Gema Lozano Sánchez, Carlos Trillo Belizon, José Manuel Ramón Salguero
Hospital Axarquía (Vélez-Málaga), Pediatrics, Málaga, Spain

Title of Case: MORAXELLA INFECTION IN PAEDIATRICS: NOT EVERYTHING IS A COLD.

Background: Infection by bacteria of the genus *Moraxella*, including *Moraxella osloensis*, has been implicated mainly in upper airway pathology and conjunctivitis. However, there are few published cases of invasive bacterial infection and osteoarticular infection in immunocompetent children.

Case Presentation Summary: A 4-year-old girl, with a history of acute pharyngotonsillitis treated with amoxicillin in the previous ten days, was taken to the hospital because of left knee pain and fever of three days' evolution. Physical examination revealed a good general condition with no clinical signs of sepsis. Examination of the locomotor system revealed local inflammatory signs and evident limitation of flexion-extension of the left knee. Results of complementary tests: blood tests showed leukocytosis with neutrophilia and marked elevation of acute phase reactants. Osteoarticular ultrasound scan compatible with joint effusion. Arthrocentesis with discharge of scant purulent material. In view of the clinical data and complementary tests, she was admitted to the hospital and empirical treatment with intravenous cefuroxime was started. During admission, an imaging study (osteoarticular MRI) showed improvement with minimal joint fluid and slight soft tissue oedema in the anterointernal region of the knee without signs of osteomyelitis. Microbiological findings: blood culture positive for multisensitive *Moraxella osloensis*, joint fluid culture negative. Close follow-up was carried out and a favourable clinical and analytical evolution was observed, without sequelae after completing four weeks of treatment.

Learning Points/Discussion: Apart from the exceptional nature of this case, invasive infections by *Moraxella* must be taken into account in the paediatric age group. After early treatment, in the absence of underlying pathology, osteoarticular infections usually have a favourable prognosis without sequelae.

EP253 / #1784

Topic: AS07. Non-respiratory infections / AS07.e. Skeletal infections

KINGELLA KINGAE TENOSYNOVITIS: A DIFFERENT APPROACH?

E-Posters

E-POSTER VIEWING

Catarina Gouveia¹, Susana Norte¹, Joana Arcangelo², Pedro Alves³, Delfim Tavares²

¹Hospital Dona Estefânia, Centro Hospitalar Universitário Lisboa Central, E.P.E, Unidade De Infeciologia Pediátrica, Lisboa, Portugal, ²Hospital Dona Estefânia, Centro Hospitalar Universitário Lisboa Central, E.P.E, Pediatric Orthopedic Unit, Lisboa, Portugal, ³Hospital Dona Estefânia, Centro Hospitalar Universitário Lisboa Central, E.P.E, Serviço De Imagiologia, Lisboa, Portugal

Backgrounds: Infectious tenosynovitis (ITS) caused by *Kingella kingae* have recently been described in young children, commonly with a mild and favourable prognosis. Our aim was to evidence a non-surgical management for *K. kingae* ITS.

Methods:: We performed a longitudinal, prospective, observational data analysis of children with *K. kingae* observed at a tertiary care hospital from 2013 to 2020.

Results: Eight (13.8%) out of 58 *K. kingae* osteoarticular infections had ITS, with a male predominance (75%) and a median age of 13.5 [12-21.8] months. All had swelling, pain, and erythema over the affected sites, with impaired ROM and 3 (37.5%) had fever. The most affected site were the extensor sides of the hand and wrist (4) and the flexor sides of the feet (4) (posterior tibialis and the flexor digitorum longus). *K. kingae* was positive from the synovial fluid in 2/3 and/or from oropharyngeal swab (PCR) in all tested (6/6). All were treated for a median 22.5 [21-28] days with cefuroxime (one with amoxicillin). Three were submitted to arthrocentesis due to concomitant arthritis, but none to tendon needle aspiration or surgical drainage. Three (37.5%) had symptoms at discharge but all regained full ROM, with no sequelae at 6-month follow-up.

Conclusions/Learning Points: *K. kingae* ITS shares the same demographic characteristics of other *K. kingae* infections, affecting younger children. These children can be treated with 15-21 days antibiotic courses with no need for surgical management.

EP254 / #1218

Topic: AS07. Non-respiratory infections / AS07.e. Skeletal infections

A CASE OF BIOFILM INFECTION ASSOCIATED WITH ORTHOPEDIC IMPLANTS

E-Posters

E-POSTER VIEWING

Seda Harutyunyan, Hrachuhi Ghazaryan, Tatev Sargsyan
Wigmore Clinic, General Pediatric, Yerevan, Armenia

Title of Case: A case of biofilm infection associated with orthopedic implants

Background: Staphylococcus aureus is a major cause of biofilm-associated infections and represents a significant healthcare system burden worldwide. The formation of a biofilm, and encasement of cells in a polymer based matrix, decreases the susceptibility to antimicrobials and immune responses, making these infections difficult to eradicate. Our aim is to report the first such case from Armenia.

Case Presentation Summary: 13 y.o. girl was admitted to the pediatric orthopedic department with diagnosis of congenital scoliosis operated elsewhere and complaints of purulent discharge from the wound. At the age of 1.5 years the girl was operated for the first time and metallic implants were installed. Afterwards, she undergone multiple revision surgeries and had surgical site wound with persistent discharge, received short course of antibiotics for 10 days. General examination revealed numerous postoperative scars on the back, with inflammation of underlying skin and discharge. Urgent revision of the wound, removal of metallic implants and bone/soft tissue culture was done. Staphylococcus aureus sensitive to Amoxicillin/Clavulonic acid, Clindamycin, Levofloxacin, Moxifloxacin grew from all samples. The patient was prescribed Clindamycin 1200mg/day and Levofloxacin 500mg/day for six weeks. At follow up visit after 1.5 month her wound was fully healed.

Learning Points/Discussion: Biofilm infections are mostly caused by S. aureus and are the most common complication associated with placement of orthopedic implants.

EP255 / #1486

Topic: AS07. Non-respiratory infections / AS07.e. Skeletal infections

ACUTE INFECTION AFTER NEUROMUSCULAR SCOLIOSIS SURGERY IN A PATIENT WITH CURRARINO SYNDROME

E-Posters

E-POSTER VIEWING

Teresa Monteiro¹, Inês Pedrosa², Regina Pinto Silva³, Ana Reis E Melo⁴, Margarida Tavares⁴
¹Centro Hospitalar e Universitário do Algarve, Paediatrics, Faro, Portugal, ²Centro Hospitalar de Leiria, Paediatrics, Leiria, Portugal, ³Centro Hospitalar Universitário de São João, Paediatrics, Porto, Portugal, ⁴Centro Hospitalar Universitário de São João, Paediatrics Infectious Diseases And Immunodeficiencies, Porto, Portugal

Title of Case: Acute infection after neuromuscular scoliosis surgery in a patient with Currarino Syndrome

Background: Perioperative infection after pediatric scoliosis surgical management is rare. Our objective is to report a case of acute infection after surgery to correct neuromuscular scoliosis in a patient with Currarino syndrome, discussing its treatment and consequent impact.

Case Presentation Summary: A 10-year-old male patient with Currarino syndrome, with global developmental delay, partial sacral agenesis and neuromuscular scoliosis, was submitted to scoliosis surgical correction with posterior instrumentation with a dual-rod system. Two weeks after surgery he was admitted to the emergency room with lethargy, fever and surgical wound drainage. In the blood analysis he presented leukocytosis and an elevated C-Reactive Protein (CRP). A CT scan showed a 49x23x78mm retrovertebral abscess collection. He was proposed for surgical debridement and cleaning and empirical antibiotherapy with intravenous (IV) vancomycin (60mg/kg/day) and cefepime (150mg/kg/day). The blood and surgical fluid microbiology culture isolated methicillin sensitive *Staphylococcus aureus* (MSSA). The previous antibiotherapy was suspended and the patient completed 2 weeks of IV flucloxacillin (600mg/kg/day) with good response. In order to avoid implants removal, the patient completed 12 weeks of antibiotherapy. So, when he was discharged from the hospital, completed an additional 10 weeks of oral antibiotherapy (flucloxacillin (100mg/kg/day) and rifampicin (10mg/kg/day)), with clinical improvement and normalization of inflammatory markers.

Learning Points/Discussion: The treatment of acute scoliosis surgery infections includes extensive debridement, with or without implants removal, and antibiotic therapy. Maintenance of implants prevents loss of correction and pseudarthrosis. In this specific case, the conservative approach, preserving the implants, seems, to date, to have been the best option.

EP256 / #1327

Topic: AS07. Non-respiratory infections / AS07.e. Skeletal infections

WHEN EIKENELLA HAS YOUR BACK

E-Posters

E-POSTER VIEWING

Quynh Pham, Sharwin Khot, Micah Secor, Sarmistha Hauger, Danielle Glade
The University of Texas at Austin, Dell Medical School, Pediatrics, Austin, United States of America

Title of Case: When Eikenella Has Your Back

Background: In the US, there are more than 3,500 reported incidents of button battery ingestion by children annually. The most common concern after ingestion is serious esophageal injury. The most common concern after ingestion is serious esophageal injury, but all adjacent structures are at risk. We present a case with a child who had serious complications from a button battery ingestion. One of them being a rare form of vertebral osteomyelitis caused by contiguous spread of oral flora.

Case Presentation Summary: 6-year-old female with Cri Du Chat, bronchoesophageal fistula secondary to button battery ingestion status post multiple stent placements/exchanges presented with one month of intermittent fever and cough. She was febrile, tachycardic, tachypneic and hypertensive. Lab work showed leukocytosis and elevated inflammatory markers. Chest x-ray reported increased right patchy infiltrates. Coarse breath sounds at bilateral bases. Exam difficult due to nonverbal state and with no focal findings. Due to persistent fevers with an unclear source, review of CT chest from one month prior revealed discitis/osteomyelitis of vertebrae that was initially thought to be a chronic process. MRI showed ongoing discitis/osteomyelitis of T2-3. Cultures of vertebral biopsy grew Eikenella and anaerobic gram-negative rods. Pathology of bone lesions was consistent with acute osteomyelitis.

Learning Points/Discussion: Button batteries can cause perforations that can lead to additional complications. Literature reports that anaerobic bacteria account for 0.8% of osteomyelitis, and there are only 12 published cases of spinal infections caused by Eikenella, most of which were of hematogenous origin. Distinctively, this case was due to contiguous spread of oral flora. Alkalinization from the battery caused posterior esophageal wall erosion, allowing entry to the prevertebral space.

EP258 / #318

Topic: AS07. Non-respiratory infections / AS07.e. Skeletal infections

MULTIFOCAL OSTEOMYELITIS IN A CHILD WITH LUMBAR PAIN AND FEVER

E-Posters

E-POSTER VIEWING

Nicola Sardi, Cristina Cravero, Paola Musso, Raffaele Basta
Ospedale SS Annunziata, Department Of Paediatrics, Savigliano, Italy

Title of Case: MULTIFOCAL OSTEOMYELITIS IN A CHILD WITH LUMBAR PAIN AND FEVER

Background: Cat-scratch disease (CSD) is an infectious disease caused by *Bartonella henselae*, a Gram-negative microorganism, generally affecting children and young adults. Immunocompetent individuals tend to develop typical CSD, with regional lymphadenopathy and a slight fever. Recently, reports of osteomyelitis due to *B.henselae* have increased: patients usually present with fever and focal pain.

Case Presentation Summary: A previously healthy 12-year-old girl presented with a 13-day history of lumbar pain and fever. On examination, the child had fever (38,5°), lumbosacral pain, no signs of inflammation or localized tenderness. Laboratory tests showed neutrophilic leucocytosis and high CRP (77 mg/L) and ESR (31 mm/H). A lumbar spine and pelvic X-ray was normal. Bone marrow aspiration revealed no morphologic and immunophenotypic abnormalities. The girl had suffered from a kitten scratch to her right hand 20 days before the admission. A spine and pelvic MRI, performed three days after the admission, showed multiple areas of increased signal intensity of D11-L1-L2-L5-S1 and of the right and left iliac ala. A presumptive diagnosis of *B.henselae* multifocal osteomyelitis was made and the child was started on IV sultamicillin and oral azithromycin. Blood cultures resulted negative; serological analysis for *B.henselae* yielded positive results. Sultamicillin was administered for 10 days, azithromycin for 7 days. Fever and lumbar pain disappeared 72 hours after the beginning of azithromycin and there was a marked improvement of the inflammatory markers. The spine and pelvic MRI, performed 3 months after discharge, showed a complete disappearance of the previous lesions.

Learning Points/Discussion: *B.henselae* osteomyelitis should be considered in cases of prolonged FUO, especially if associated with focal pain. MRI, together with serological assays and PCR analysis, are useful for the final diagnosis.

EP259 / #595

Topic: AS07. Non-respiratory infections / AS07.e. Skeletal infections

CLINICAL, DIAGNOSTIC AND THERAPEUTIC PROFILE OF CHILDREN ADMITTED WITH OSTEOARTICULAR INFECTIONS: A SINGLE CENTRE RETROSPECTIVE OBSERVATIONAL STUDY

E-Posters

E-POSTER VIEWING

Bhaskar Shenoy, Harshini Reddy, Devesh Joshi, Baliwanth Anandakrishnan
Manipal Hospital, Pediatrics, Bangalore, India

Backgrounds: Bone and joint infections in children are one of the most difficult-to-treat diseases. Despite availability of new generation antibiotics and modern diagnostic modalities, diagnosing and managing osteoarticular infections remains challenging.

Methods: A retrospective audit was performed on children aged 0 to 18 years, admitted to Manipal Hospital, Bangalore, India between January 2010 and December 2019 with osteoarticular infection. We reviewed the clinical presentation, microbiological and radiological investigations, management, and outcomes of those children.

Results: Out of 100 children, Bimodal age distribution observed between 1-5 years and 11-18 years, 28% each. Male: Female ratio 1.5:1. 47% were diagnosed as acute osteomyelitis, 28% septic arthritis 15%, chronic osteomyelitis, 7% acute multifocal osteomyelitis, 2% acute osteomyelitis with septic arthritis and 1% chronic tubercular multifocal osteomyelitis. Predominant joint involved in septic arthritis was knee joint(39.3%) followed by hip joint(32.1%). Predominant bone involved in osteomyelitis was femur(28.6%) followed by tibia(26%). The yield from pus/fluid culture, gene-xpert tb and blood culture were 42%, 3% and 6% respectively. Predominant organism isolated was MSSA (52.4%) followed by MRSA(31.1%). MRI was performed in 88% and USG in 80% of subjects to aid the diagnosis. Most used antibiotics were amikacin(47%), ceftriaxone(40%), vancomycin(29%) and clindamycin(27%). 4 weeks of antibiotics received by 57% and 6 weeks by 18%. 85% were managed surgically, arthrotomy was the most common procedure(50.6%). 29% of subjects had complications, Common complications were abscess(55.2%), septic arthritis(24.1%), and myositis(20.7%).

Conclusions/Learning Points: Although yield from pus/fluid culture is higher than blood culture, early MRI can increase diagnostic yield. Common organism identified remains staphylococcus aureus (MSSA). Antibiotic prescription differs between treating clinicians. Duration of antibiotics varies between 2-6 weeks. Most patients underwent surgical management with antibiotic coverage. Majority of children did not develop early complications.

EP260 / #1871

Topic: AS07. Non-respiratory infections / AS07.e. Skeletal infections

KINGELLA KINGAE SUBACUTE OSTEOMYELITIS IN CHILDREN

E-Posters

E-POSTER VIEWING

Beatriz Sousa Nunes¹, Joana Arcangelo², Susana Norte², Pedro Alves³, Delfin Tavares², Catarina Gouveia⁴

¹Hospital de Dona Estefânia, CHULC-EPE, Paediatrics, Lisbon, Portugal, ²Hospital de Dona Estefânia, CHULC-EPE, Paediatric Orthopedic Unit, Lisbon, Portugal, ³Hospital de Dona Estefânia, CHULC-EPE, Paediatric Radiology Unit, Lisbon, Portugal, ⁴Hospital de Dona Estefânia, CHULC-EPE, Paediatrics Infectious Diseases Unit, Lisbon, Portugal

Backgrounds: Subacute osteomyelitis (SAO) is an insidious infection difficult to diagnose. Recently, *K. kingae* has been identified as a common etiological agent in young children. The aim is to characterize *K. kingae* SAO in children admitted to a tertiary care hospital.

Methods:: Longitudinal observational study of children with *K. kingae* SAO admitted to a tertiary care paediatric hospital over an 8-year period (2013-2020). The parameters included demographics, clinical data, treatment, and disease progression.

Results: 10 children (17.2% of all *K. kingae* infections) with a male to female ratio of 1,5:1 and a median age of 24 months, IQR 24 (12-36). The most common symptoms were functional impairment and pain, with only three (30%) presenting with fever. The median duration of symptoms was 21 days (IQR 10.5). Involvement of the lower extremities (70%) was more frequent, often at the tarsal bones (40%), and 50% had concurrent septic arthritis. Seven had intraosseous abscess, three epiphyseal involvement, three chondritis, and three concomitant tenosynovitis. All blood cultures were negative. Bone cultures were positive in 3/5 patients. *K. kingae* PCR was positive in 8 patients: bone (2/2), synovial fluid (2/2), oropharyngeal swab (8/8, in 4 patients was the only positive test). Cefuroxime and amoxicillin-clavulanate were used for treatment, with a median duration of 28 days (IQR 9). Surgical intervention was performed in 60%: bone drainage (2), puncture (2), and arthrocentesis (2). No sequelae were observed and all osteolytic lesions disappeared with complete bone reconstruction.

Conclusions/Learning Points: *K. kingae* SAO is an important cause of osteoarticular infections in young children. These infections have a benign course. Shorter antibiotic courses and less surgical interventions are also safe and effective.

EP261 / #1234

Topic: AS07. Non-respiratory infections / AS07.e. Skeletal infections

CHILDREN WITH LYME ARTHRITIS IN SLOVENIA

E-Posters

E-POSTER VIEWING

Katarina Vincek¹, Natalija Bahovec¹, Tanja Avramoska¹, Aida Granda¹, Minca Mramor¹, Tatjana Mrvič¹, Tina Plankar Srovin¹, Mojca Rožič¹, Urška Šivic¹, Marko Pokorn², Mojca Kolnik¹, Gaja Setnikar Kimovec¹, Petra Prunk Križanec¹, Živa Lenarčič¹, Maja Arnež¹

¹University Medical Centre Ljubljana, Department Of Infectious Diseases, Ljubljana, Slovenia, ²University Medical Centre Ljubljana, Department Of Infectious Diseases And Faculty Of Medicine, Ljubljana, Slovenia

Title of Case: Lyme arthritis

Background: Lyme borreliosis is a tick-borne infectious disease caused by *B. burgdorferi sensu lato*. Lyme arthritis is a late disseminated manifestation of the disease. Hospital database search for patients with Lyme arthritis younger than 18 years old treated at the Department of Infectious diseases, University Medical Centre Ljubljana from 2014 to 2022 and retrospective data analysis was performed. Lyme arthritis was defined by the Slovenian guidelines for Lyme disease.

Case Presentation Summary: In a 8-year period a total of 20 children was diagnosed with Lyme arthritis with a median age of 11 years. In all patients, the knee was the affected joint. Joint swelling was observed in all patients with accompanying pain and warmth in 85 % and 65 % respectively. Additional symptoms or signs (headaches, mild fever or erythema migrans) were observed in seven patients. The median duration of arthritis upon initiating treatment was 7 days. Eleven patients (57 %) had increased sedimentation rate (ESR) with average value 25 mm/h (2 to 58 mm/h). C-reactive protein value (mg/L) ranged from five to 185, with a median of 9.

Arthrocentesis was performed in all patients. Synovial fluid PCR testing for *B. burgdorferi* DNA was performed in all patients, 13 patients (65 %) tested positive. Blood samples from 19 patients were analysed for specific IgM and IgG antibodies to *B. burgdorferi sensu lato*, in all IgG antibodies were positive. Eighteen patients (90 %) were treated intravenously with ceftriaxone.

Learning Points/Discussion: In our case series of Lyme arthritis, the knee was the only affected joint. Associated fever, as well as redness of the involved joint, is rare. All patients had positive IgG antibodies to *B. burgdorferi*. Ceftriaxone is the antibiotic of choice according to Slovenian guidelines.

EP262 / #464

Topic: AS07. Non-respiratory infections / AS07.f. Skin Infections

METHICILLIN AND CLINDAMYCIN RESISTANT STAPHYLOCOCCUS AUREUS INFECTIONS IN CHILDREN ADMITTED TO A GENERAL HOSPITAL FROM BUENOS AIRES, ARGENTINA

E-Posters

E-POSTER VIEWING

Martin Brizuela¹, Verónica Kozicki², Rafael Vilaltella², Silvina Pidala², Sebastián Galiñanes²

¹Hospital General de Agudos "Dalmacio Vélez Sarsfield", Pediatrics, Buenos Aires, Argentina, ²Hospital Isidoro Iriarte, Pediatrics, Quilmes, Argentina

Title of Case: Methicillin and clindamycin resistant *Staphylococcus aureus* infections in children admitted to a general hospital from Buenos Aires, Argentina

Background: *Staphylococcus aureus* (SA) produces infections of variable severity. Antibiotic resistance has increased in recent years. Clindamycin is the recommended empirical treatment where reported resistance is less than 15%.

Case Presentation Summary: Objectives: to determine the frequency of isolates of methicillin resistant *Staphylococcus aureus* (MRSA) and clindamycin in hospitalized children between 2017-2019. Population and methods: retrospective, descriptive, observational study. MRSA isolates from children hospitalized between 2017-2019 were included. Results: 41 patients (p) were included. 54% (n = 22) were male. The median age was 51 months. There were 10 MRSA in 2017, 16 in 2018 and 15 in 2019. MRSA resistant to clindamycin 0 in 2017), 1 in 2018) and 4 in 2019. Resistance to clindamycin during entire period was 12%. 38 skin and soft tissue samples, 6 blood cultures and 2 joint fluids were included. MRSA resistant to clindamycin was isolated from soft tissues. There were 15 patients who received previous antibiotics, 23 patients with overcrowding, and 6 boils that were repeated. The median hospital stay was 4 days. The intravenous antibiotic was clindamycin. The definitive oral antibiotic was trimethoprim sulfamethoxazole and clindamycin. No patient died.

Learning Points/Discussion: In this series there was an increase in isolates of MRSA resistant to clindamycin. We did not find factors associated with this increase. Although for the moment clindamycin continues to be the indicated empirical treatment, we must be attentive to resistance patterns

EP263 / #758

Topic: AS07. Non-respiratory infections / AS07.f. Skin Infections

A DIMPLE ON THE TEMPORAL REGION

E-Posters

E-POSTER VIEWING

María Belén Hernández Rupérez¹, David Aguilera Alonso², Jesús Saavedra Lozano², Concepción Lorca García³, Raquel Villamor Martín¹, María Isabel Coch Martínez¹, Sara García Guixot¹, Laura Álvarez-Cuervo¹, Ana María González Fernández¹, Sara Lapeña Maján¹, María Del Carmen Temboursy Molina¹

¹University Sureste Hospital, Paediatrics, Arganda del Rey, Madrid, Spain, ²Hospital General Universitario Gregorio Marañón, Paediatric Infectious Diseases, Madrid, Spain, ³Hospital General Universitario Gregorio Marañón, Paediatric Plastic Surgery, Madrid, Spain

Title of Case: A dimple on the temporal region

Background: Dermoid cysts of the frontotemporal region usually present as superficial, slow-growing masses without deep extension.

Case Presentation Summary: A three year-old girl was referred to a hospital consultation due to two recurrent periorbital cellulitis in her left eyelid. She had a dimple on her left temporal region since her birth. She also had atopic dermatitis. Her parents were from India and they had been living there the year before. At the age of 2 year-old she was admitted to an Indian hospital because of left periorbital cellulitis with a marked left eyelid swelling and suppuration from the little dimple on the left temporal area. A cerebral-CT was performed but the medical report was not available. She was treated with intravenous antibiotics and drained of purulent material, with good progress. Then, at the age of 2 years 8 months, she presented erythema and mild pain around the little dimple on her left temporal region, followed by left periorbital swelling and erythema, and finally releasing pus from the dimple. No fever was associated. She was treated with oral antibiotic with uneventful recovery. Nowadays, physical examination showed a dimple of 1mm on the left temporal area without inflammation. An ultrasound was performed suspecting a temporal dermoid cyst with an associated draining sinus tract.

Learning Points/Discussion: Rarely, dermoid cysts of the frontotemporal region may be associated with a cutaneous fistula or with an intracranial extension. It is suggested that frontotemporal dermoid cysts with associated draining sinus tracts or excessive recurrent inflammation may require preoperative imaging because of the high likelihood of intracranial extension. Failure to recognize and treat these lesions may lead to recurrent infection with a potential for meningitis or cerebral abscess.

EP264 / #388

Topic: AS07. Non-respiratory infections / AS07.f. Skin Infections

A CASE OF PEDIATRIC ORBITAL ABSCESS TREATED WITH EMERGENCY SURGERY OVERGROWTH OF STREPTOCOCCUS INTERMEDIUS DURING THE PANDEMIC PERIOD

E-Posters

E-POSTER VIEWING

Eda Boz¹, Yalçın Kara², Mahmut Kizil², Ömer Kılıç², Hamdi Çaklı³, Ener Çağrı Dinleyici⁴

¹Eskişehir Osmangazi Medical University, Pediatric, Eskişehir, Turkey, ²Eskişehir Osmangazi University, Pediatric Infectious, Eskişehir, Turkey, ³Eskişehir Osmangazi Medical University, Ear Nose Throat Department, Eskişehir, Turkey, ⁴Eskişehir Osmangazi Medical University, Pediatric Intensive Care, Eskişehir, Turkey

Title of Case: A case of pediatric orbital abscess treated with emergency surgery overgrowth of Streptococcus intermedius during the pandemic period

Background: Preseptal and orbital cellulitis is a bacterial infection of the eye and orbital tissues that affects the majority of the population. Preseptal cellulitis is an infection of the tissues anterior to the orbital septum; orbital abscess is an infection of the tissues posterior to the orbital septum. It usually occurs as a complication of paranasal sinus infections in childhood. Here, we present a 4-year-old boy diagnosed orbital abscess after ethmoidal sinusitis and treated emergency surgical drainage on the pandemic area.

Case Presentation Summary: A 4-year-old male patient presented with swelling, redness, and limitation of eye movements in the right eye. From his history, he had been using oral antibiotics for acute tonsillitis about a week, and the swelling in the eye gradually increased. Physical examination revealed significant proptosis, a purulent abscess, and painful eye movements in the right eye. In the laboratory, the leukocyte was 19000 mm³, C-reactive protein was 82.5 mg/L. Right ethmoid sinusitis and huge right orbital abscess were found on computed tomography. Vancomycin, clindamycin, treatment were started. The patient, consulted urgently to the Departments of Otorhinolaryngology and Ophthalmology, was taken to emergency operation and endoscopic sinus drainage was performed. Streptococcus intermedius growth in abscess sample, and antibiotic therapy was completed for ten days. The patient was discharged after the eye edema and ocular movements returned to normal.

Learning Points/Discussion: Orbital abscess is rare but causes serious complications in childhood, especially after paranasal sinus infections. Sinusitis in children should be diagnosed and treated early, especially during the pandemic period, and orbital abscess should be considered in children presenting with swelling in the eye and limited eye movements.

EP265 / #385

Topic: AS07. Non-respiratory infections / AS07.f. Skin Infections

CASE REPORT: PEDIATRIC CUTANEOUS LARVA MIGRANS IN SOUTH TEXAS WITH SUPERIMPOSED BACTERIAL INFECTION

E-Posters

E-POSTER VIEWING

Guyu Li¹, Melissa Gannon², Urvashi Mathur², Estela O'Daniell³

¹Driscoll Children's Hospital/ Texas A&M College of Medicine, Department Of Pediatrics, Corpus Christi, United States of America, ²UT Health Rio Grande Valley School of Medicine, Department Of Pediatrics, Edinburg, United States of America, ³Driscoll Children's Hospital/ Texas A&M College of Medicine, Department Of Emergency Medicine, Corpus Christi, United States of America

Title of Case: Case Report: Pediatric Cutaneous Larva Migrans in South Texas with Superimposed Bacterial Infection

Background: Cutaneous larva migrans (CLM) is a diagnostic phrase commonly used to describe the visual appearance of subcutaneous larval migration of nematodes. The filariform larvae of these worms are usually introduced through the skin via contaminated soil or sand, causing intense pruritus and giving the characteristic serpiginous, "creeping eruption" track mark. Bullae and folliculitis can present in the early stage of CLM. The disease is diagnosed clinically and is usually self-limited after several weeks, though albendazole may hasten the resolution of prolonged symptoms.

Case Presentation Summary: A 5-year-old female was brought to the emergency department (ED) for evaluation of clear drainage from the central lesion (Figure A, B), which was formed by stepping on a rock barefoot. She was admitted for a right foot puncture wound with the complication of suspected bacterial infection. Clindamycin and Incision & Drainage had small improvements on lesions, and the intense itching got worse at night that woke her up from sleep. In the second ED visit, there was worsening urticaria with expanding serpiginous and raised lesions extending from the original central wound (Figure C, D). The clinical features and physical exam were consistent with a diagnosis of cutaneous larva migrans. At the follow-up, symptoms resolved with oral Albendazole in a week.



Learning Points/Discussion: Further history revealed that the patient often walked barefoot outdoors, and her family had various pets. Understanding the risk factors and clinical presentations of CLM ensures higher chances of accurate diagnosis and appropriate treatment, which could further lead to a swift recovery, decrease the likelihood of secondary complications, and avoid side effects of antibiotic therapy.

EP266 / #513

Topic: AS07. Non-respiratory infections / AS07.f. Skin Infections

ECZEMA COXSACKIUM: AN UNCOMMON COMPLICATION OF ATOPIC DERMATITIS

E-Posters

E-POSTER VIEWING

Lara Navarro, Helena Silva, Lídia Leite
Hospital de Braga, Paediatrics, Braga, Portugal

Title of Case: ECZEMA COXSACKIUM: AN UNCOMMON COMPLICATION OF ATOPIC DERMATITIS

Background: Atopic dermatitis (AD) is a chronic inflammatory skin disease that is complicated by an increased risk for skin and systemic infections. One of these complications could be eczema coxsackium, caused by an enterovirus (commonly coxsackievirus A6), and can be described as atypical hand, foot and mouth disease (HFM). It is characterized by an eruption of vesicles, bullae, and erosions affecting areas of active or inactive atopic dermatitis. Differential diagnoses include varicella zoster infection, eczema herpeticum, and bullous impetigo.

Case Presentation Summary: An 11-months-old boy was brought for evaluation of a rash and fever of 2 days' duration. He had atopic dermatitis since 2 months of age that was poorly controlled with low-potency topical corticosteroids. His pre-existing dermatitis lesions had worsened, with increased itching and some skin breakdown. On physical examination he presented irritable and had multiple erythematous papules and vesicles with crusts on the perioral area, trunk and extremities, and had a distribution almost on the same areas of atopic dermatitis. The polymerase chain reaction (PCR) tests for vesicle fluid were positive for coxsackievirus A6 but negative for herpes simplex virus, confirming diagnosis of eczema coxsackium.

Learning Points/Discussion: This case report will increase awareness of this form of atypical HFM disease, and an early diagnosis can prevent inappropriate use of antibiotics or acyclovir.

EP267 / #1912

Topic: AS07. Non-respiratory infections / AS07.f. Skin Infections

FROM KITTENS AFFECTION TO HUMAN INFECTION-FAMILY OUTBREAK OF CAT SCRATCH DISEASE

E-Posters

E-POSTER VIEWING

Magdalena Pluta^{1,2}, Marta Lipińska^{1,2}, Ewa Talarek^{1,2}, Maria Pokorska-Śpiewak^{1,2}, Magdalena Marczyńska^{1,2}

¹Medical University of Warsaw, Poland, Department Of Children's Infectious Diseases, Warsaw, Poland, ²Warsaw's Hospital for Infectious Diseases, Department Of Children's Infectious Diseases, Warsaw, Poland

Title of Case: FROM KITTENS AFFECTION TO HUMAN INFECTION-FAMILY OUTBREAK OF CAT SCRATCH DISEASE

Background: Cat scratch diseases (CSD) is a bacterial infection caused by *Bartonella henselae*. Most infections occur after scratches or bites from domestic or stray cats, especially kittens. The most common symptoms include fever, lymphadenopathy or a pustule at the scratch site. Rarely, infections of the eye, liver, spleen, brain, bones, or heart valves can occur. Here we report simultaneous outbreak of CSD in 3 siblings.

Case Presentation Summary: A 7.5-year-old girl and her 2 siblings (5-year-old twins) were referred to the hospital with tender unilateral axillary lymphadenopathy preceded by mild fever and symptoms of upper respiratory tract infection. Erythematous, maculopapular eruptions were observed on their palms and their forearms were covered with healed scratches. All of them were exposed to kittens' bites and licks. Laboratory tests revealed normal CBC with mildly elevated CRP. Serological testing for *Bartonella henselae* IgM was positive. HIV, Toxoplasmosis, EBV, CMV infections were ruled out. The chest radiograph showed no abnormalities. They were diagnosed with CSD and received treatment with clarithromycin, which resulted in the resolution of the swollen lymph nodes.



Learning Points/Discussion: Differential diagnosis of regional lymphadenopathy should include CSD. Treatment with antibiotics in immunocompetent patients is usually not necessary, but may help reduce lymph node swelling.

EP268 / #1147

Topic: *AS07. Non-respiratory infections / AS07.g. STDs*

USER FEEDBACK ON A MULTICOMPONENT EDUCATIONAL HPV VACCINATION PROMOTION PACKAGE FOR PARENTS AND ADOLESCENTS

E-Posters

E-POSTER VIEWING

Laveeza Butt, Janita Pak Chun Chau, Suzanne Hoi Shan Lo

The Chinese University of Hong Kong, The Nethersole School Of Nursing, Hong Kong, Hong Kong PRC

Backgrounds: HPV vaccination is an effective form of prevention against cervical cancer and has been recommended for girls aged 9-14 years. However, uptake among this demographic remains low due to poor understanding of HPV infection risk, vaccine safety concerns, misinformation, and more. It is therefore necessary for interventions aiming to address vaccine hesitancy to be tailored to the information needs of parents and adolescents. This study was conducted to explore parent and adolescent views of educational resources developed for a novel HPV vaccination promotion programme.

Methods: A qualitative study with in-depth semi-structured interviews was conducted. Sixteen participants, comprising eight mother-daughter dyads, were recruited. Educational resources for the programme included nine educational videos, a digital game, and one information booklet. Participants were asked about their views on the suitability and effectiveness of the resources. Interviews were audio-recorded and the resulting data were thematically analyzed.

Results: All resources were generally well-received and able to generate positive vaccination intention among participants. Parents noted that the resources contained comprehensive information on the topic which raised their awareness regarding the purpose of HPV vaccination and increased their confidence in vaccine safety. They also expressed a positive and more urgent intention to vaccinate their children in the near future. Adolescents were equally receptive to the resources and expressed high acceptability towards the vaccination, suggesting congruence with their parents' improved perception of HPV vaccination.

Conclusions/Learning Points: Tailored educational resources are effective in improving knowledge and perceptions of HPV vaccination among parents and adolescents. It is likely that the novel HPV vaccination programme will positively influence HPV vaccine uptake rate among female adolescents. Funding: This study is supported by the General Research Fund, University Grants Committee, Hong Kong.

EP269 / #733

Topic: AS08. Respiratory infections (only non-SARS-CoV2 content) / AS08.a. Viral respiratory infections

HRSV INFECTION DURING THE COVID-19 PANDEMIC IN ALGERIA

E-Posters

E-POSTER VIEWING

Sarah Belkalem¹, Fatiha Djedjig², Kahina Izri¹, Alia Gradi¹, Sonia Hasnaoui², Selma Bouheraoua², Nada Rasha Hamadouche², Warda Drali³, Hachemi Maouche⁴, Azzedine Mekki³, Leila Smati⁵, Rachida Boukari⁶, Aicha Bensalem⁷, Hassiba Tali Maamer², Fawzi Derrar¹

¹Pasteur Institute of Algeria (IPA), Viral Respiratory Laboratory, National Influenza Center, Algiers, Algeria, ²Pasteur Institute of Algeria (IPA), Medical Bacteriology Laboratory, Algiers, Algeria, ³CHU NefissaHamoud, Pediatric Ward, Algiers, Algeria, ⁴EPH Hassan Badi, Pediatric Ward, Algiers, Algeria, ⁵EPH Bologhine, Pediatric Ward, Algiers, Algeria, ⁶CHU Mustapha Pacha, Pediatric Ward, Algiers, Algeria, ⁷Pasteur Institute of Algeria (IPA), Viral Hepatitis Laboratory, Virology Department, Algiers, Algeria

Backgrounds: Viruses are known as the predominant causative pathogens of Acute Respiratory Tract Infection (ARI). Human Respiratory Syncytial Virus (hRSV) is the main etiology of respiratory tract illness among infants and young children. The aim of our study was to investigate of common agents in children under 5 years old admitted with ARI using syndromic approach.

Methods: Study conducted from 5 October to 7 December 2021. A total of 111 nasopharyngeal samplings and 1 bronchoalveolar lavage were collected from children under 5 years of age with ARI (64,8% under 2 months). Among them 16,2 % were addressed for pertussis diagnosis. Samples were screened for common pathogens (viral and bacterial) using a nested multiplex PCR assay (Biofire Filmarray). All hRSV infections were confirmed and classified using a CDC rRT-PCR hRSV protocol.

Results: Among 111 children, 77% presented bronchiolitis, 7,2% presented bronchopneumopathy and 45% had respiratory distress, 59,5% of patients received antibiotics. We report 98,2% (110/112) of positivity in PCR multiplex. 89,09% (98/110) hRSV, 29% (32/109) hRSV in co-infection, 8,9% (10/112) other respiratory viruses and 1,7% (2/110) SARS-COV-2. Among the 98 hRSV detected, we observed co-circulation of hRSV-A and hRSV-B, with hRSV-A as the predominant group. Clinical features associated with hRSV infection were similar to those of other respiratory viruses.

Conclusions/Learning Points: Some countries reported the increasing hRSV infection. The high spread of the hRSV infection lies mainly in the fact that few young children are immune to hRSV, as the spread has been low over the past two seasons, especially due to restrictions on covid-19. The ability to provide timely identification of the causative agents of ARIs by rapid molecular testing, based on the syndromic approach promote better patient outcomes and decreasing empirical antibiotic use and duration.

EP270 / #1281

Topic: AS08. Respiratory infections (only non-SARS-CoV2 content) / AS08.a. Viral respiratory infections

IMPACT OF RESPIRATORY VIRAL PANEL TESTING ON THE USE OF ANTIBIOTICS AMONG CHILDREN ADMITTED WITH INFLUENZA LIKE ILLNESS IN A TERTIARY CARE HOSPITAL

E-Posters

E-POSTER VIEWING

Praveena Bhaskaran¹, Veena Menon², Ajai Krishnan², Soumya Jose², Roshni Jerome²

¹Amrita Institute of Medical Sciences, Infectious Diseases, Kochi, India, ²Amrita Institute of Medical Sciences, Virology, Kochi, India

Backgrounds: Acute respiratory infections are one of the most common reasons for prescribing antibiotics among pediatric patients in low middle income countries, even though majority of them have viral aetiology. Here we aimed to study the impact of respiratory viral panel testing on the use of antibiotics among children admitted with influenza like illness in a tertiary care hospital in urban India during the first 2 years after the test was introduced.

Methods: A retrospective 2-year (Jan 2019 – Jan 2021) analysis was done on paediatric patients (≤ 18 years) who were admitted with symptoms of influenza like illness in whom respiratory viral panel testing was done within 24 hours of admission, using the commercially available Fast Track Diagnostic (FTD®) Respiratory Pathogens 33 multiplex kit that had 12 respiratory viral targets. Mean duration of antibiotics among patients who had a positive viral panel test was compared with those who had a negative report.

Results: Of the total 1470 ILI cases, 127 patient samples were tested using RVP. Viral positivity was noted in 71.6% (91/127) cases. Rhinovirus was the most frequently reported virus (22.8 %; 29/127) followed by Parainfluenza (15.7%), Influenza A/B (11.8 %) and RSV (11.8 %). Mean duration of antibiotics among those with positive viral panel report was marginally low (6.2 days) compared to those who had a negative report (7.4 days), but the difference was not statistically significant.

Conclusions/Learning Points: The mean duration of antibiotics in pediatric patients with ILI with a positive viral panel test was not statistically different from those who had a negative test in the first 2 years after the introduction of the test in a tertiary care urban hospital in LMIC setting.

EP271 / #640

Topic: AS08. Respiratory infections (only non-SARS-CoV2 content) / AS08.a. Viral respiratory infections

IMPACT OF REDUCED EXPOSURE TO RESPIRATORY VIRUSES IN THE PREVIOUS YEAR ON THE EPIDEMIOLOGY OF BRONCHIOLITIS IN A TERTIARY PAEDIATRIC INTENSIVE CARE UNIT (PICU).

E-Posters

E-POSTER VIEWING

Ingrid Burkhardt¹, Rebecca Mitting², Elizabeth Whittaker³

¹Imperial College Healthcare NHS Trust, Children's Services, London, United Kingdom, ²Imperial College Healthcare NHS Trust, Pediatric Intensive Care Unit, London, United Kingdom, ³Imperial Healthcare NHS Trust, Paediatric Infectious Diseases, London, United Kingdom

Backgrounds: Many young children had reduced exposure to respiratory viruses for part of their life due to non-pharmaceutical interventions (NPI) associated with the COVID-19 pandemic starting March 2020. The aim is to describe the potential impact of COVID-19 infections, NPIs and subsequent relaxing of these on bronchiolitis admissions to a tertiary referral PICU in London.

Methods: Retrospective chart review. Data from 01/03/2019-29/02/2020 ("baseline") compared to 01/03/2020-28/02/2021 ("NPI") containing significant periods of NPIs, and 01/03/2021-31/10/2021 ("opening") when most NPIs were gradually lifted.

Results:

| | March 2019- February 2020 – “baseline” | March 2021- October 2021 – “opening” | P Value (Mann Whitney U test for continuous variables, chi squared to compare proportions) |
|---|--|--------------------------------------|--|
| Admissions | | | |
| Total admissions n | 91 | 71 | |
| Monthly admissions median (IQR) | 5 (3-7.5) | 6 (3-13.5) | P=0.67 |
| Age distribution | | | |
| Age (days) Median (IQR) | 82 (37-190) | 136 (41-281) | P=0.1 |
| Children aged >365 days n(%) | 7 (7.7%) | 13 (18.3%) | P<0.05 |
| Viral pathogens | | | |
| RSV single infection n(%) | 27 (29.7%) | 27 (38.0%) | P=0.26 |
| REV single infection n(%) | 21 (23.1%) | 22 (31.0%) | P=0.26 |
| Sars-CoV-2 infection n(%) | - | 0 (0%) | |
| Single infection with another respiratory viral pathogen n(%) | 9 (9.9%) | 2 (2.8%) | P=0.08 |
| Infection with >1 viral respiratory pathogen n(%) | 31 (34.1%) | 14 (19.7%) | P<0.05 |
| No respiratory viral pathogen identified n(%) | 3 (3.3%) | 6 (8.5%) | P=0.23 |
| Severity of disease | | | |
| Length of stay days Median (IQR) | 5.1 (3.6-6.5) | 3.9 (2.9-5.1) | P<0.01 |
| Invasively ventilated n(%) | 81 (89.0%) | 57 (80.1%) | P=0.12 |
| Duration of ventilation days Median (IQR) | 5 (4-6) | 4 (3-5) | p<0.01 |

Table 1: Main results comparing the “baseline” to “opening” period in children with bronchiolitis admitted to a tertiary PICU. Abbreviations: RSV - Respiratory Syncytial Virus; REV - Rhino/Enterovirus; Sars-CoV-2 – Severe acute respiratory syndrome coronavirus 2.

The “NPI” period confirms previously described absence of Respiratory Syncytial Virus (RSV) bronchiolitis, but ongoing Rhino/Enterovirus infections. Other indicators were highly flawed by changed PICU logistics and closures. Comparing “baseline” to “opening” period (see Table 1) we found an early peak and increase in admissions/month, an increase in median age, and increase in the proportion of children >365 days of age. However, median length of stay, proportion of children mechanically ventilated and median ventilation days decreased. No cases of severe acute respiratory syndrome coronavirus 2 (Sars-CoV-2) bronchiolitis, but an increase in the proportion of single infection with Rhino/Enterovirus and RSV were seen.

Conclusions/Learning Points: The increase in PICU admissions after the “NPI” period suggests increased susceptibility and/or circulation of respiratory viruses. The increased frequency of children over one-year points towards unusually severe disease in children above the at-risk age. However, overall, there are no indicators of more severe disease among those admitted to PICU. Sars-CoV-2 does not play a role in severe bronchiolitis, but Rhino/Enterovirus single infection is disproportionately present when

other pathogens are absent. Awareness of these changes is highly relevant for clinicians and PICU leads to rapidly adapt and provide high-level care in such exceptional but potentially recurring circumstances.

EP272 / #1508

Topic: AS08. Respiratory infections (only non-SARS-CoV2 content) / AS08.a. Viral respiratory infections

PLASTIC BRONCHITIS DUE TO RESPIRATORY SYNCYTIAL VIRUS INFECTION: A CASE REPORT

E-Posters

E-POSTER VIEWING

Eleni Christakou, Maria Gianniki, Marilena Prapa, Theodoros Pantazopoulos, Vanessa Dimitropoulou, Panagiotis Poulos
AGIA SOFIA Children's Hospital, Picu, ATHENS, Greece

Title of Case: PLASTIC BRONCHITIS DUE TO RESPIRATORY SYNCYTIAL VIRUS INFECTION: A CASE REPORT

Background: Plastic bronchitis(PB) is a rare pulmonary disorder characterized by the production of cohesive,branching casts filling the airways.An inflammatory insult leading to abnormal accumulation of mucin,fibrin,or chyle in the airways was proposed as PB pathogenesis.

Case Presentation Summary: We report a pediatric case of PB secondary to respiratory syncytial virus(RSV) infection.A previously healthy 3,5-year-old boy who presented with an 10-day history of persistent cough and a few hours history of fever,respiratory distress and hypoxia was referred to our hospital.On admission the boy had decreased breath sounds on his right lung.Initial chest radiograph was unremarkable.Treatment with corticosteroids and bronchodilators was initiated.Within hours the patient developed severe hypoxemia with central cyanosis and was immediately intubated and ventilated with great difficulty.He underwent emergency rigid bronchoscopy which showed complete obstruction of the right primary bronchi by a whitish rubbery material.A bronchial tree-like cast was extracted via suctioning.The patient's ventilation improved immediately.Flexible bronchoscopy and bronchoalveolar lavage was also performed and had to be repeated the next day due to clinical deterioration.Chest CTscan revealed not complete resolution of right upper and middle lobe atelectasis.RT-PCR of nasopharyngeal and endotracheal aspirate was positive for RSV.The boy was weaned off the ventilator after 3days and discharged from PICU after 4days.Pathology of casts demonstrated fibrin and mucin containing mainly neutrophils,eosinophils and few lymphocytes.

Learning Points/Discussion: PB is a serious condition,which can cause asphyxiation and death if left untreated.Early recognition and proper treatment of children is essential and includes bronchoscopy for airway clearance.PB secondary to RSV infection in a toddler is indicative of the intensity of RSV resurgence with a peak in older children,during last months of 2021, after the reduction of CoronavirusDisease2019-related public health measures.

EP273 / #570

Topic: AS08. Respiratory infections (only non-SARS-CoV2 content) / AS08.a. Viral respiratory infections

A SEVERE NEUTROPENIA CASE RELATED TO RESPIRATORY SYNCYTIAL VIRUS

E-Posters

E-POSTER VIEWING

Berfu Ülgen¹, Zeynep Ergenç², Oguzhan Delican¹, Sevgi Aslan², Seyhan Yılmaz², Eda Kepenekli²
¹Marmara University School of Medicine, Pediatrics, Istanbul, Turkey, ²Marmara University School of Medicine, Pediatric Infectious Diseases, Istanbul, Turkey

Title of Case: A Severe Neutropenia Case Related to Respiratory Syncytial Virus

Background: Respiratory syncytial virus (RSV) is a virus that belongs to the Pneumoviridae family and targets the respiratory tract. It is presumed that almost all children younger than two years of age are infected with RSV at least once. Bone marrow suppression secondary to infection is rare in RSV infections. In this case report, a patient who developed RSV bronchiolitis and concurrent severe neutropenia is discussed.

Case Presentation Summary: An 8.5-month-old male patient presented with fever and cough to the emergency department. His physical examination revealed, body temperature: 38.3°C, his respiratory rate: 50/min, and the expirium time was long. The absolute neutrophil count (ANC) was found 300 cells/mm³ and the nasal swab RSV antigen test was positive. The patient was admitted with the diagnosis of acute bronchiolitis. Blood test results were as followings: WBC: 6800 cells/mm³, ANC: 400 cells/mm³, lymphocyte count: 5200 cells/mm³, hemoglobin: 10.4 mg/dL, platelet count: 315000 cells/mm³, C-reactive protein: 11 mg/L. No atypical cells were observed in the peripheral blood smear, and reactive lymphocytosis and neutrophil count were found to be compatible with the total blood count. No abnormality was detected in the immunophenotyping, vaccine response tests, and measurement of immunoglobulin levels. He was followed with the diagnosis of bone marrow suppression secondary to infection. ANC was found 1200 cells/mm³ in the first week after discharge, and 1600 cells/mm³ in the sixth month.

Learning Points/Discussion: RSV rarely causes bone marrow suppression. Care should be taken in terms of malignancy and primary immunodeficiency, and the patient should be kept under close follow-up until the cytopenia recovers.

EP275 / #1437

Topic: AS08. Respiratory infections (only non-SARS-CoV2 content) / AS08.a. Viral respiratory infections

VIRAL PATHOGEN DETECTION IN YOUNG CHILDREN WITH RHINORRHEA

E-Posters

E-POSTER VIEWING

Elandri Fourie¹, Yara Sijm¹, Paul Badoux², Sjoerd Euser², Marlies A. Van Houten^{1,3}

¹Spaarne Gasthuis, Science Institute Vaccine, Infection And Immunology, Hoofddorp, Netherlands, ²Regional Public Health Laboratory Kennemerland, Laboratory, Haarlem, Netherlands, ³Spaarne Gasthuis, Department Of Pediatrics, Haarlem and Hoofddorp, Netherlands

Backgrounds: Respiratory tract infections (RTI) are the most common cause of illness in childhood and remain a cause of disease burden worldwide. Nasopharyngeal (NP) and oropharyngeal (OP) swabs are widely applied for respiratory pathogen detection, but hold several disadvantages particularly for children. The current SARS-CoV-2 pandemic highlights the importance of child friendly diagnosis of RTI. We aim to evaluate the performance and tolerability of a rhinorrhea swab in detecting viral pathogens compared to a combined NP/OP or mid-turbinate (MT) nasal swab.

Methods: This ongoing study is being conducted at the emergency room and pediatric unit of the Spaarne Gasthuis hospital. Children between the age of 0 and 5 years, suspected of an upper respiratory tract infection were included and received a combined- and a rhinorrhea swab. Viral pathogens were detected using multiplex PCR and SARS-CoV-2 RT-PCR. Tolerability of both methods were evaluated with a questionnaire and VAS-scores.

Results: At this moment, 45 children were included of whom 43 (96%) tested positive for a total of 64 viral pathogens. In two children no virus was detected in the samples. In 11 (24%) of the cases a co-infection was found with two and in 3 (7%) with even three viral pathogens. The sensitivity and specificity of the rhinorrhea swab compared to a combined swab were respectively 95% [95%CI 0.84-0.99] and 67% [95%CI 0.21-0.94]. The mean VAS scores for the rhinorrhea swab was significantly lower compared to the combined nasal swab (2 vs. 7).

Conclusions/Learning Points: This study shows that viral pathogens can be detected just as effectively in a rhinorrhea swab as in the combined swab in young children. In addition, the significant difference in VAS-score shows it is a more accepted and tolerated test.

EP276 / #470

Topic: AS08. Respiratory infections (only non-SARS-CoV2 content) / AS08.a. Viral respiratory infections

UNDERSTANDING THE BURDEN OF SEVERE INFLUENZA AMONG YOUNG CHILDREN IN PORTUGAL OVER TEN EPIDEMIC SEASONS

E-Posters

E-POSTER VIEWING

Filipe Froes¹, Mafalda Carmo², Hugo Lopes³, Cátia Marques⁴, Margarida Martins⁵, H el ene Bricout⁶, Caroline De Courville⁷, Jaime Correia De Sousa⁸, Carlos Raba al⁹, Jo o Filipe Raposo¹⁰, Carlos Robalo Cordeiro¹¹

¹Centro Hospitalar Universit rio Lisboa Norte, Icu, Thorax Department, Lisbon, Portugal, ²IQVIA, Real World Insights, Barcelona, Spain, ³IQVIA, Healthcare, Lisbon, Portugal, ⁴Sanofi Pasteur, Value & Access, Lisbon, Portugal, ⁵Sanofi Pasteur, Vaccines Public Affairs, Lisbon, Portugal, ⁶Sanofi Pasteur, Franchise Development, Lyon, France, ⁷Sanofi Pasteur, Global Health Economics And Value Assessment, Lyon, France, ⁸University of Minho, School Of Medicine, Braga, Portugal, ⁹Vila Franca de Xira Hospital, Cardiology Department, Lisbon, Portugal, ¹⁰APDP and Nova Medical School, Medical Faculty, Lisbon, Portugal, ¹¹Coimbra University Hospital, Pulmonology Department, Coimbra, Portugal

Backgrounds: Although recommended by the World Health Organisation, routine widespread immunisation against influenza in children aged 6 months to 5 years is not yet endorsed in many European countries, including Portugal (unless included in the chronic diseases or immunocompromised at-risk group). Our goal was to study the burden of severe influenza among young children in Portugal.

Methods: The burden of influenza was described considering all National Health Service hospitalizations coded with influenza-specific diagnosis (ICD-9 487-488 or ICD-10 J09-J11), as primary or secondary diagnosis, excluding hospitalizations due to the following reasons: musculoskeletal; births; alcohol; mental disease; programmed activity. In-hospital mortality was evaluated based on discharge status and corresponds to the hospitalization episodes classified as influenza which resulted in in-hospital death. The analyses were conducted in children aged <5 years over ten epidemic seasons (2008/09-2017/18).

Results: A total of 2,319 hospitalizations coded as influenza were identified over 10 seasons in children aged <5 years. Mean annual hospitalization rate per 100,000 ranged between 22.8 and 123.5, depending on the season (Table 1). Mean length-of-stay ranged between 4.4 and 7.0 days. Mechanical ventilation (MV) and/or oxygen enrichment were used in 18.8% to 42.6% of hospitalizations coded as influenza. The use of invasive MV ranged between 0.9% and 4.9%. Four deaths were observed during hospitalizations coded as influenza, resulting in an overall in-hospital mortality rate of 0.2%. The share of children hospitalized for influenza presenting at least a comorbidity ranged between 5.1% and 17.2%.

Table 1. Influenza attributed clinical outcomes in children aged <5 years, in Portugal (seasons 2008/09-2017/18^(a))

| Variable | 2008/09 | 2009/10 ^(b) | 2010/11 | 2011/12 | 2012/13 | 2013/14 | 2014/15 | 2015/16 | 2016/17 | 2017/18 |
|---|---------|------------------------|------------------|---------|------------------|--------------------------|----------|----------------|---------|---------|
| Predominant influenza virus | A(H3) | A(H1)pd m09 | B/A(H1)p dm09 | A(H3) | B/A(H1)p dm09 | A(H1)pd m09/ A(H3) | B/ A(H3) | A(H1)pd m09 | A(H3) | B |
| Number of hospitalizations for influenza | 117 | 617 | 158 | 128 | 122 | 180 | 154 | 340 | 170 | 333 |
| Hospitalizations for influenza per 100,000 children <5 years old | 22.8 | 123.5 | 32.2 | 26.6 | 26.3 | 40.0 | 35.3 | 79.4 | 39.9 | 77.4 |
| Number of deaths during hospitalizations for influenza | - | 1 | 1 | - | 1 | - | - | 1 | - | - |
| In-hospital mortality rate (%) | 0.0% | 0.2% | 0.6% | 0.0% | 0.8% | 0.0% | 0.0% | 0.3% | 0.0% | 0.0% |
| Mean length-of-stay (days) | 4.4 | 5.1 | 6.6 | 6.8 | 6.6 | 7.0 | 5.3 | 6.0 | 6.3 | 5.9 |
| Use of invasive MV (%) | 0.9% | 2.1% | 3.2% | 4.7% | 4.9% | 1.1% | 1.3% | 2.9% | 1.8% | 1.8% |
| Use of non-invasive MV (%) | 0.9% | 0.6% | 3.2% | 1.6% | 3.3% | 3.3% | 3.2% | 2.4% | 2.9% | 5.1% |
| Use of any MV or oxygen enrichment (%) | 18.8% | 19.6% | 38.6% | 35.2% | 42.6% | 32.8% | 33.1% | 39.7% | 42.4% | 36.0% |
| Hospitalizations for influenza in which the child had at least a comorbidity (%) | 5.1% | 8.4% | 5.7% | 17.2% | 13.1% | 10.0% | 12.3% | 12.9% | 12.4% | 10.8% |

MV – Mechanical Ventilation; NHS – National Health Service.
 (a) Epidemic season includes cases from September to June in NHS hospitalizations coded as influenza; (b) Pandemic season.

Conclusions/Learning Points: Results suggest that children aged <5 years may experience severe outcomes from influenza infections, in terms of hospitalizations, required resources and, potentially, deaths. In-depth studies for this age group are needed to help guide decisions on specific preventive strategies.

EP278 / #973

Topic: AS08. Respiratory infections (only non-SARS-CoV2 content) / AS08.a. Viral respiratory infections

EPIDEMIOLOGICAL MONITORING OF BRONCHIOLITIS CASES IN PEDIATRIC INFECTIOUS DISEASE WARD IN SOUTHERN ITALY

E-Posters

E-POSTER VIEWING

Gabriel Gustafsson Hall¹, [Rita Grandolfo](#)², Azzurra Orlandi², Claudio Cafagno², Desiree Caselli²
¹Visby hospital, Infectious Diseases, Visby, Sweden, ²POLICLINICO BARI, Pediatrics, BARI, Italy

Backgrounds: Clinical bronchiolitis cases in the pediatric infectious disease department of Giovanni XXIII Pediatric Hospital, Bari, Italy, were monitored during October -December 2021 for epidemiology with the aim to study the current outbreak

Methods: Nasopharyngeal swab for PCR for respiratory virus and bacteria was performed in while the patients were admitted in the hospital

Results: From October to december 2021 52cases of bronchiolitis were admitted. In 86% (=45) of cases ,respiratory Syncytial Virus (RSV) was found on nasopharyngeal swabs of bronchiolitis cases, comprised of 19% (=10) RSV type A and 67%(=35) RSV type B. In the remaining case, H.influenzae, parainfluenza virus and rhinovirus 4%(n=2) respectively were found. In total 42 of bronchiolitis cases also had co-infection or trace of colonizing bacteria. In 7 cases RSV and Rhinovirus were found simultaneously

Conclusions/Learning Points: RSV was found in 86% of bronchiolitis cases and is by far the most common and likely cause of bronchiolitis. rhinovirus was often found together with RSV but rarely alone, suggesting it is not the main epidemiological driver of bronchiolitis. it was quite common to find traces of other virus or bacteria with PCR technique, though it remains to be understood if these coinfections contribute to the bronchiolitis clinical disease or are asymptomatic

EP279 / #1341

Topic: AS08. Respiratory infections (only non-SARS-CoV2 content) / AS08.a. Viral respiratory infections

PANORAMA OF THE RESPIRATORY PATHOGENS CAUSING HOSPITALIZATION DURING THE COVID-19 PANDEMIC IN A PEDIATRIC REFERENCE CENTER IN SAO PAULO, BRAZIL

E-Posters

E-POSTER VIEWING

Giovanna Guerra¹, Marcus Martuchelli¹, Camila Morais¹, Danielle Leal², Daniel Jarovsky¹, Flávia Almeida¹, Marco Aurélio Palazzi Sáfadi¹, Eitan Berezin¹

¹Santa Casa de São Paulo, Pediatric Infectious Diseases, São Paulo, Brazil, ²Instituto Ciencias Biológicas do Hospital das Clínicas, Virologia, Sao Paulo, Brazil

Backgrounds: During the COVID-19 pandemic, there were drastic changes in the circulation of respiratory viruses worldwide. Our objective is to evaluate children admitted to a tertiary teaching hospital with respiratory symptoms and describe the most prevalent respiratory viruses affecting the pediatric group.

Methods: During 2020 and 2021 we have performed pharyngeal swab specimens for all the children under 15 years old admitted with respiratory diseases. We've used an RT-PCR assay to detect a broad range of respiratory viruses, including SARS-CoV-2. Results from 2020 and 2021 were compared.

Results: A total of 1081 samples were collected - 329 in 2020 and 752 in 2021. Overall, 67.5% (n=730) were younger than five-years-old and 44.5% (n=482) were younger than two-years-old. The most frequent virus found in 2020 was SARS-CoV-2 (n=28) followed by RSV (n=16). Conversely, in 2021 RSV was found in 165 patients (21.9%), followed by parainfluenza (7%; n=53), and bocavirus (4.2%; n=32). In total, 416 patients were admitted due to severe acute respiratory syndrome (SRAG); respiratory virus (RSV) was the leading microorganism in this group (64.2%; n=267), while SARS-CoV-2 was detected in only 2 children. Most of the patients with RSV (41%) were admitted from August through November 2021.

RESPIRATORY VIRUS 2020-2021

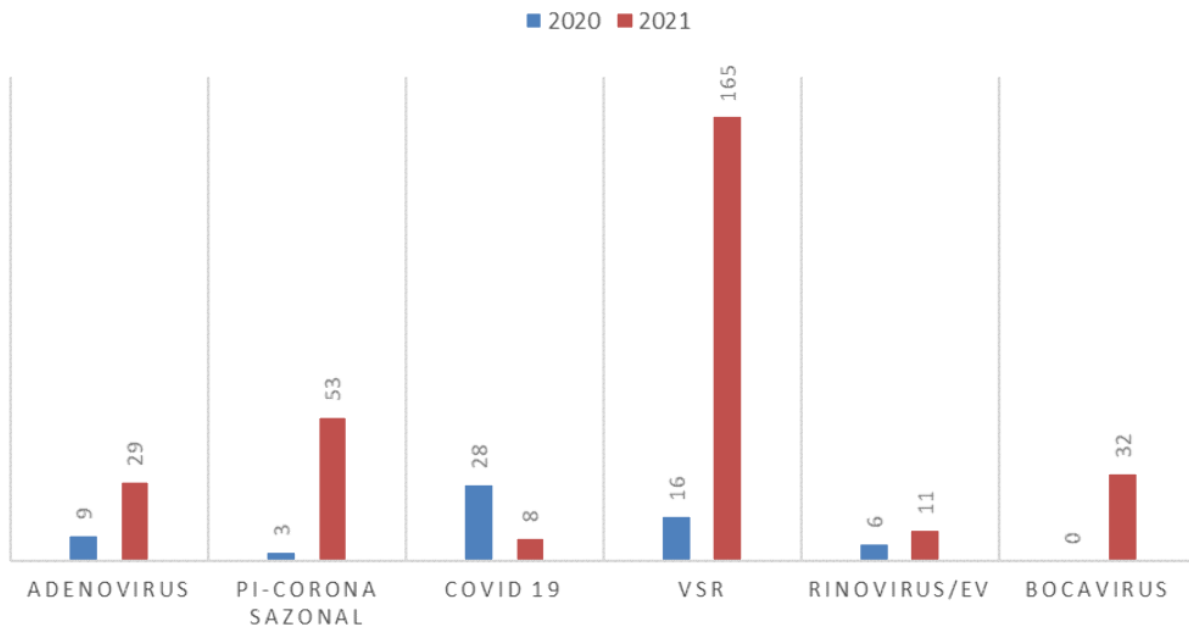

Conclusions/Learning Points: RSV is still the leading virus causing SRAG in the pediatric group. Its circulation period was unique since in Brazil it generally peaks from March to July.

EP280 / #909

Topic: AS08. Respiratory infections (only non-SARS-CoV2 content) / AS08.a. Viral respiratory infections

EPIDEMIOLOGY OF RESPIRATORY SYNCYTIAL VIRUS BRONCHIOLITIS IN HOSPITALIZED INFANT AT A TERTIARY HOSPITAL IN IZUMO CITY, JAPAN, 2011–2021

E-Posters

E-POSTER VIEWING

Tomohiro Hirade, Daisuke Koike, Kenji Yamada, Rikako Okamura, Fumihide Kato
Shimane Prefectural Central Hospital, Pediatrics, Izumo, Japan

Backgrounds: Respiratory syncytial virus (RSV) is the most important cause of bronchiolitis. During COVID-19 pandemic, the incidence of RSV infection has dramatically decreased and then resurged in many countries. The epidemiology of RSV infection is influenced by various factors including other viral epidemics, weather, and geographic area. There is no standard management for viral bronchiolitis. The aim of this study was to identify changes in the epidemiology and management of RSV bronchiolitis at a tertiary hospital in Japan.

Methods: We retrospectively analyzed the records of infants hospitalized with RSV bronchiolitis from 2011 to 2021. RSV infection was diagnosed using a rapid RSV antigen test on nasopharyngeal swab sample. Bronchiolitis was defined as a first episode of wheezing in infants aged younger than 2 years.

Results: The annual peak of RSV infection gradually shifted from the winter to the autumn. The mean age at admission was 9.4 months (SD: 1.2). Approximately 100 infants were hospitalized annually. Only 3 infants were hospitalized in 2020, influenced by COVID-19 pandemic; however, there was a resurgence of RSV infection in 2021, and 94 infants were hospitalized during July and September. The proportion of neonatal patients rose from 4–5% before the COVID-19 pandemic to 13% in 2021. The length of hospital stay decreased from 6 days in 2010–2013 to 4 days in 2018–2021. In 2021, the mean interval from onset to admission was 3.9 days (SD: 1.4). Overall, 89% of the patients underwent chest radiography. Furthermore, β -agonists, antibiotics, and dexamethasone were administered to 14%, 54%, and 63% of the patients, respectively. No children required ICU admission.

Conclusions/Learning Points: The COVID-19 pandemic influenced the epidemiology of RSV infection. Management of RSV bronchiolitis needs more consideration.

EP281 / #1302

Topic: AS08. Respiratory infections (only non-SARS-CoV2 content) / AS08.a. Viral respiratory infections

ETIOLOGIC STRUCTURE OF LOWER RESPIRATORY TRACT INFECTION IN HOSPITALIZED CHILDREN UNDER 5 YEARS

E-Posters

E-POSTER VIEWING

Maia Kherkheulidze¹, Ivane Chkhaidze¹, Nani Kavlashvili¹, Lia Palavanishvili², Eka Kandelaki¹
¹State Medical University, Pediatrics, Tbilisi, Georgia, ²lashvili Children's hospital, Pediatrics, Tbilisi, Georgia

Backgrounds: Acute respiratory tract infections are the most common causes of morbidity and mortality in children less than 5 years.

Methods: The aim of your study was to evaluate the etiologic structure of lower respiratory tract infection in randomly selected hospitalized children (acute bronchitis, bronchiolitis, pneumonia) under 5 years. . Patients with suggested bacterial infection (Leukocytosis, elevated C reactive protein, and procalcitonin) were excluded. Totally 81 children's medical records were analyzed. The etiologic structure was evaluated by PCR .

Results: 50,6 % (n=41) patents were under 1 year, 27,1 % (n=22) from 1 to 2 years and 22,3 % (n=18) from 3 to 5 years. 17,2 % (n=14) were admitted PICU. Most frequent clinical symptoms was cough 96,2%(n=78), high fever $\geq 38^{\circ}\text{C}$ – 85,1 % (n=69), difficult breathing 40,7 % (n=33). In 41,9 % (n=34) were diagnosed acute bronchiolitis, 25,9 % (n=21) bronchitis and 32,2 % (n=26) pneumonia. Most cases of bronchiolitis and pneumonia were caused by RSV infection 70,3% (n=57), Influenza type B was identified in 8,6 % (n=7), and adenovirus 2,4 %(n=2). Mixed infection with 2 viruses was revealed in 16,0 % (n=13) and mixed infection with 3 different viruses was in 2,4 % (n=2). In cases of mixed infections combination of RSV and Adenoviral infection s was identified in 8,6 %(n=7), RSV with bokaviral and metapneumovirus infection (3,7 % n=3). The risk factors for PICU admission is age (<6 months), prematurity, delayed admission.

Conclusions/Learning Points: So we can conclude causes of lower respiratory tract viral infections especially in case of bronchiolitis and pneumonia are mainly caused by RSV , Adeno virus and influenza

EP282 / #931

Topic: AS08. Respiratory infections (only non-SARS-CoV2 content) / AS08.a. Viral respiratory infections

CHANGES IN THE EPIDEMIOLOGY AND CLINICAL FEATURES OF HUMAN PARAINFLUENZA VIRUS TYPE 3 INFECTION IN KOREAN CHILDREN BEFORE AND DURING THE COVID-19 PANDEMIC

E-Posters

E-POSTER VIEWING

Ye Kyung Kim, Seungha Song, Bin Ahn, Ki Wook Yun, Eun Hwa Choi
Seoul National University Children's Hospital, Pediatrics, Seoul, Korea, Republic of

Backgrounds: Dramatic reductions in non-SARS-CoV-2 respiratory virus infections were observed alongside public health measures during the COVID-19 pandemic. However, a resurgence of human parainfluenza virus type 3 (hPIV3) was captured in South Korea in late 2021. This study aimed to investigate the epidemiologic and clinical features of hPIV3 infection in Korean children before and during the COVID-19.

Methods: We reviewed medical records of children infected with hPIV3 at Seoul National University Children's Hospital from 2018 to 2021. Changes in the epidemiology, clinical characteristics and severity were analyzed and compared between the pre-COVID-19 period (2018-2019) and the COVID-19 period (2020-2021).

Results: A total of 261 cases with hPIV3 infection were identified; 71 in 2018, 99 in 2019, zero in 2020, 91 in 2021. Eighty-two percent (n=139/170) of hPIV3 were detected from May to August in 2018-2019; however, all the cases surged from September to December in 2021. The male to female ratio was 1.23:1 and the median age was 25 months (range, 9-58 months), which were comparable between the two periods. The proportions of lower respiratory infection as clinical diagnosis, need of hospitalization, respiratory support, and outcome of hPIV3 infections were not significantly different between the two study periods. However, the intensive care unit admission was more frequent in 2021 than in 2018-2019 (11.0% vs 4.1%, p=0.032), even though the proportion of children with underlying disease were significantly lower in 2021 than in 2018-2019 (83.5% in 2018-2019, 70.3% in 2021, p=0.013).

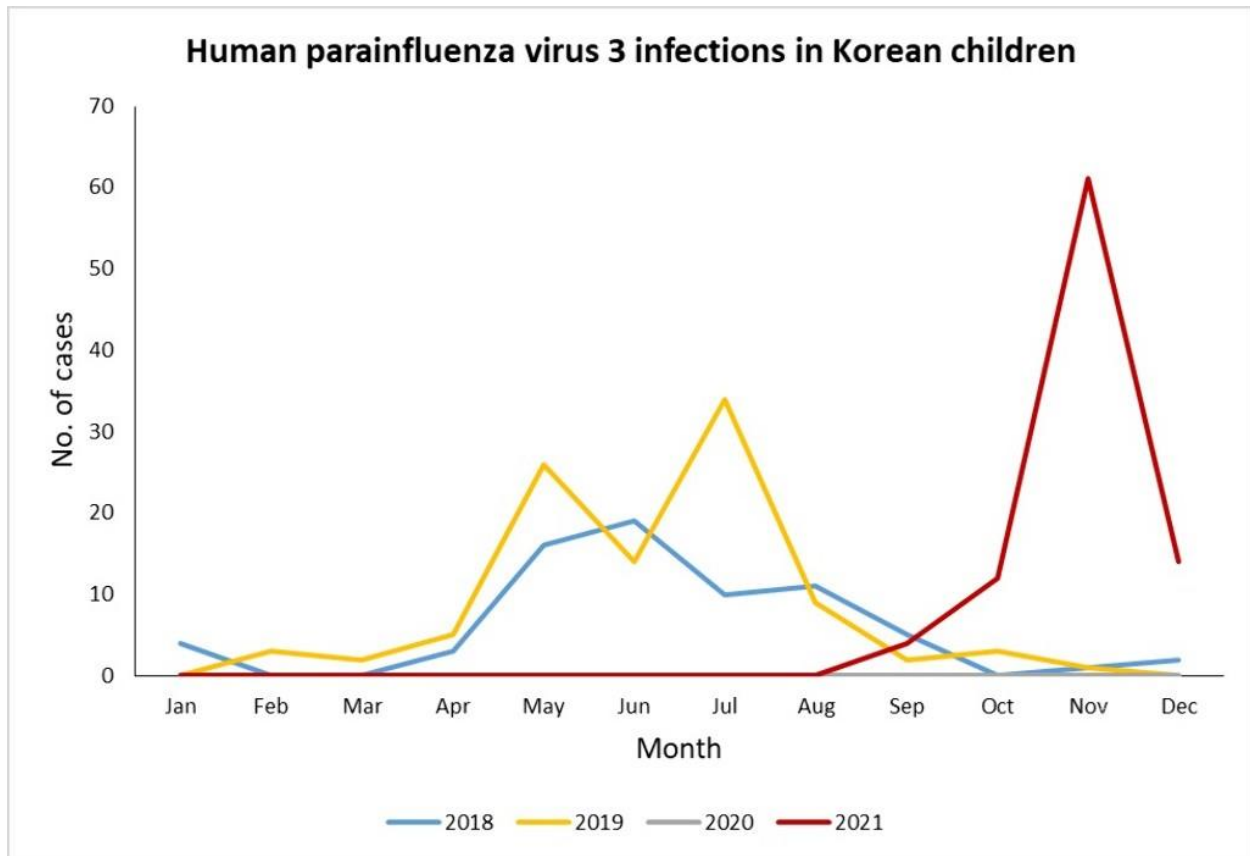

Conclusions/Learning Points: COVID-19 may directly or indirectly affect the epidemiology and severity of non-SARS-COV-2 respiratory virus infections. During the COVID-19 pandemic, the onset of hPIV3 outbreak was delayed compared to previous years, and the proportion of in-patient requiring intensive care increased.

EP283 / #1386

Topic: AS08. Respiratory infections (only non-SARS-CoV2 content) / AS08.a. Viral respiratory infections

COMPARISON OF THE SEVERITY OF DISEASE CAUSED BY RSV IN YOUNGER CHILDREN WITH OTHER RESPIRATORY VIRUSES

E-Posters

E-POSTER VIEWING

Joana Oliveira¹, Ana Rita Jesus¹, Miguel Félix², Fernanda Rodrigues¹

¹Hospital Pediátrico, Centro Hospitalar e Universitário de Coimbra, Infectious Diseases Unit And Emergency Service, Coimbra, Portugal, ²Hospital Pediátrico, Centro Hospitalar e Universitário de Coimbra, Pneumology Department, Coimbra, Portugal

Backgrounds: Viruses are a common cause of respiratory infections in young children with important impact in all levels of pediatric healthcare. The aim of this study was to compare the severity of RSV infections with other respiratory viruses, using the ReSVinet Score.

Methods: This is a prospective observational study including all hospitalized children under 24 months of age with acute respiratory infection (with symptoms lasting for less than 5 days), from March to December 2021. A nasopharyngeal sample was taken and submitted to PCR detection (FilmArray respiratory panel).

Results: A total of 97 children were included. RSV was found in 69 children (71%), in 46 (67%) as the only virus and in 23 (33%) with at least another virus; 28 children had a virus other than RSV (Metapneumovirus, Adenovirus, Coronavirus NL63/OC43, Parainfluenza 3, Rhinovirus/Enterovirus, SARS-CoV2). Children with RSV alone were compared with cases with RSV and other virus(es) and there were no significant differences in gender, mean age, duration of disease at admission, duration of admission and final diagnosis. Accordingly, the comparison of all children with RSV and children with other viruses is presented in the table.

Table

| | RSV n=69 | Other viruses n=28 | <i>p value</i> |
|--|--|---|-----------------------|
| Gender male female | 35 (50.7) 24 (49.3) | 11 (39.3) 17 (60.7) | 0.307 |
| Average age in months (standard deviation) | 6.15 (0.69) | 9.87 (1.57) | <0.001 |
| Duration of admission in days (standard deviation) | 4.55 (0.75) | 2.25 (0.58) | 0.061 |
| Final diagnosis Rhinopharyngitis Bronchiolitis Pneumonia Laryngitis Bronchitis | 2 (2.9) 57 (82.6) 9 (10.0) 0 (0.0) 1 (1.4) | 11 (39.3) 9 (32.1) 6 (21.4) 2 (7.1) 0 (0.0) | <0.001 |
| ReSVinet Score mild moderate severe | 7 (10.1) 54 (78.3) 8 (11.6) | 9 (32.1) 17 (60.7) 2 (7.1) | 0.029 |

Conclusions/Learning Points: Disease caused by RSV was found in younger children, mostly with bronchiolitis and was more severe than that caused by other viruses.

EP284 / #1160

Topic: AS08. Respiratory infections (only non-SARS-CoV2 content) / AS08.a. Viral respiratory infections

EPIDEMIOLOGICAL CHANGES OF RESPIRATORY SYNCYTIAL VIRUS DURING THE COVID-19 PANDEMIC

E-Posters

E-POSTER VIEWING

Eider Oñate¹, Marta Traba¹, Maria Estefania Llorente¹, Tania Martin², Maitane Arrastia², Maria Milagrosa Montes²

¹Donostia University Hospital, Pediatrics, San Sebastian, Spain, ²Donostia University Hospital, Microbiology, San Sebastian, Spain

Backgrounds: The epidemiology of respiratory syncytial virus (RSV) infection has changed during the COVID-19 pandemic probably due to strict non-pharmacological interventions (NPIs) including lockdowns. Our objectives were to describe clinical and epidemiologic characteristics of children hospitalized during the pandemic (PAN) and compare with admissions due to RSV in previous years. (PRES)

Methods: Observational and retrospective study performed in a large pediatric hospital (Donostia University Hospital: assisted population: 54119 children < 14 years) by reviewing the RSV admissions from June 2018 to December 2021 comparing the epidemiological and clinical data in the seasons July 2018-June 2019 and July 2019-June 2020 with the seasons after the pandemic outbreak.

Results: 363 children were admitted for RSV infection during the study period. 215 in PRE period and 148 in PAN. The mean-age of all patients was $3,84 \pm 4,4$ months. It was slightly non-significant higher in PAN ($4.26 \pm 5,18 / 3,54 \pm 3,76$; $Z=0.12$) being sex distribution homogeneous. The number of admissions in 2020-2021 was significantly lower than in other seasons (3% versus 25%, 34%, 38%). The peak of cases was detected in PRE in autumn-winter. In 2020-2021 season there were only 11 cases, 1 in August and 10 in May. During 2021-2022 season (until December 2021) there was a large increase in cases from week 23 reaching two peaks, one in July with 20 cases and the greatest one in November with 41. The percentage of admissions in PICU was higher in 2021 than in PRE (26%/11%; $P=0,02$)

Conclusions/Learning Points: The peak of RSV infection in 2021 moved to summer with no cases in autumn-winter 2020-2021. RSV in season 2021-2022 is causing significantly a more severe infection. Our data suggest that infectious diseases like bronchiolitis do not become real epidemics when transmission is inhibited by NPIs, practiced by adults and older children.

EP285 / #1003

Topic: AS08. Respiratory infections (only non-SARS-CoV2 content) / AS08.a. Viral respiratory infections

ANTIBIOTIC TREATMENT IN CHILDREN WITH RESPIRATORY SYNCYTIAL VIRUS (RSV) BRONCHIOLITIS

E-Posters

E-POSTER VIEWING

Eleni Maria Papatesta¹, Eleni Kourkouni², Maria Tsolia¹, Nikos Spyridis¹

¹National and Kapodistrian University of Athens, Second Department Of Pediatrics, "p.&a. Kyriakou" Children's Hospital, Athens, Greece, ²CLEO, Center For Clinical Epidemiology And Outcomes Research, Athens, Greece

Backgrounds: Although routine antibiotic therapy (ABT) in children with RSV bronchiolitis is not recommended, overuse is observed in clinical practice.

Methods: Prospective study of children <24 months old with RSV bronchiolitis, hospitalized at a tertiary pediatric hospital between December 2017-May 2018. Exclusion criteria were serious underlying conditions and previous episode(s) of bronchiolitis. Type of ABT used, length of use, and reason for administration were recorded.

Results: 172 children (median age 2 months, IQR 1-4) were included. 79 (45.9%) received ABT (median duration 2.5 days, IQR 2-4). Antibiotics used where ampicillin/amoxicillin (77.2%), cefotaxime/cefuroxime (22.8%), aminoglycosides (10.1%) and macrolides (7.5%). ABT was administered due to abnormal chest X-ray (CXR) (31.6%), acute otitis media (21.5%), fever in infants <2 months old (8.9%), urinary tract infection (5.1%), bacteremia (2.5%) and for 21.5% the reason was not mentioned. Children who received more frequently ABT where those with fever (57.5% vs 37.4%; p=0.009), who underwent CXR (71.7% vs 16.2%; p=0.001), whose CXR exhibited confluent opacities/consolidation (93.3.% vs 61.3%; p=0.002), who were admitted to ICU (81.3% vs 42.3%; p=0.003) and who presented higher CRP (median 4 vs 2; p=0.001). Children who had a family member with a concurrent viral infection received ABT at a lower percentage (37.8% vs 56.8%; p=0.013). After multiple regression analysis was performed, it was observed that children admitted to the ICU and who underwent CXR were 12.6 (p=0.005) and 8 times (p = 0.001) more likely to receive ABT respectively. An increase of CRP by 1 unit increased the chance of ABT by 10% (p = 0.003).

Conclusions/Learning Points: Despite our growing knowledge of RSV infection and the very low risk of concurrent serious bacterial infection, the rates of ABT remain high. Therefore, targeted and monitored use is imperative.

EP286 / #1143

Topic: AS08. Respiratory infections (only non-SARS-CoV2 content) / AS08.a. Viral respiratory infections

ACUTE BRONCHIOLITIS: RESPIRATORY SYNCYTIAL VIRUS (RSV) VS NON-RSV BRONCHIOLITIS

E-Posters

E-POSTER VIEWING

Eleni Maria Papatesta¹, Eleni Kourkouni², Minos Matsas³, Maria Papadimitriou³, Maria Tsolia¹, Nikos Spyridis¹

¹National and Kapodistrian University of Athens, Second Department Of Pediatrics, "p.&a. Kyriakou" Children's Hospital, Athens, Greece, ²CLEO, Center For Clinical Epidemiology And Outcomes Research, Athens, Greece, ³P&A.Kyriakou Children's Hospital, Department Of Microbiology, Athens, Greece

Backgrounds: Numerous viruses cause acute bronchiolitis, with the most common pathogen being RSV for about 50-80% of the cases. Conflicting data exist in the literature concerning the association between the etiologic virus and disease severity.

Methods: Prospective study of children <24 months old with acute bronchiolitis who were admitted at a tertiary pediatric hospital between December 2017-May 2018. Children were divided into RSV and non-RSV groups. Demographic data, clinical characteristics, exams performed, and medications received were documented.

Results: 247 children, 195 (78.9%) RSV and 52 non-RSV were included. A higher percentage of boys was observed in the non-RSV group (75% vs 59%; p=0.034). More children had a family member with a concurrent viral infection (57% vs 41.2%; p=0.044) in the RSV group. Although there were no significant differences observed between the two groups regarding exams performed, in the RSV group the reason for performing chest radiographs was recorded in a greater percentage (37.6% vs 16.0%; p=0.04). Non-RSV children had higher WBC (median 13650 vs 11100/ μ L; p = 0.001). The non-RSV group received salbutamol at a higher percentage (50% vs 33.3%; p=0.027) but there were no significant differences regarding the use of oxygen, racemic epinephrine, corticosteroids, and antibiotics. 10.8% of the RSV children were admitted to the ICU and none from the non-RSV group (p=0.013). Moreover, the duration of hospitalization in the non-RSV group was shorter (median 3 vs 4 days; p=0.031).

Conclusions/Learning Points: In our study children with RSV bronchiolitis presented a more severe course of illness in terms of admission to the ICU and hospital stay compared to non-RSV children.

EP287 / #567

Topic: AS08. Respiratory infections (only non-SARS-CoV2 content) / AS08.a. Viral respiratory infections

LEVEL OF MATERNAL ANTIBODIES AGAINST RESPIRATORY SYNCYTIAL VIRUS (RSV) NUCLEOPROTEIN AT BIRTH AND RISK OF RSV VERY-SEVERE LOWER RESPIRATORY TRACT INFECTION

E-Posters

E-POSTER VIEWING

Matthieu Receveur¹, Jean-Sebastien Casalegno²

¹Hospices Civils de Lyon, Hôpital Femme Mère Enfant, Service De Réanimation Pédiatrique Et D'accueil Des Urgences, Bron, France, ²Hospices Civils de Lyon, Institut Des Agents Infectieux - Hopital De La Croix-rousse, Lyon, France

Backgrounds: The nucleoprotein (N protein) of respiratory syncytial virus (RSV) is a candidate antigen for new RSV vaccine development. The aim of the present study was to investigate the association between maternal antibody titers against the RSV N protein at birth and the newborns' risk of developing very-severe lower respiratory tract infection (VS-LRTI).

Methods: In this single-center prospective cohort study, 578 infants born during the RSV epidemic season in France were included. Among these, 36 were hospitalized for RSV VS-LRTI. A generalized linear model was used to test the occurrence of a VS-LRTI in function of sex, mode of delivery, parity of the mother, type of pregnancy, date of birth in relation to the peak of the epidemic, and antibody titer against N protein.

Results: All cord blood samples had detectable antibodies against N protein. The mean titers were significantly lower in newborns with risk factors for RSV severe LRTI (preterm infants, birth before the peak epidemic, multiparous mother). There was no association between antibody titer against the N protein and a protection against VS-LRTI.

Conclusions/Learning Points: The present study found that transfer of maternal antibodies against the RSV N protein may not provide a significant immune protection early in infancy.

EP289 / #810

Topic: AS08. Respiratory infections (only non-SARS-CoV2 content) / AS08.a. Viral respiratory infections

RESPIRATORY VIRUS SURVEILLANCE IN HOSPITALIZED CHILDREN LESS THAN 2-YEARS OF AGE IN KENEMA, SIERRA LEONE DURING THE COVID-19 PANDEMIC (OCTOBER 2020-DECEMBER 2021).

E-Posters

E-POSTER VIEWING

Robert Samuels¹, Ibrahim Sumah¹, Foday Alhasan¹, Rendie Mchenry², Laura Short², James Chappell², Zaid Haddadin², Natasha Halasa², Donald Grant¹, John Schieffelin³, Troy Moon²
¹Kenema Government Hospital, Pediatrics, Kenema, Sierra Leone, ²Vanderbilt University, Department Of Pediatrics, Division Of Pediatric Infectious Diseases, Nashville, United States of America, ³Tulane University, Pediatrics, Division Of Infectious Diseases, New Orleans, United States of America

Backgrounds: Acute respiratory tract infections (ARI) are a main cause of pediatric morbidity and mortality worldwide. Knowledge about the current causes of viral respiratory infections in low resource settings is lacking. The aim of this study was to identify the viral pathogens associated with ARI in hospitalized children < 2 years of age in Sierra Leone.

Methods: We conducted a prospective, cohort study of children <24 months of age admitted to the Kenema Government Hospital (KGH) with acute respiratory symptoms between October 1, 2020 and December 31, 2021. Two nasal swabs were collected from each child at admission. Swabs were stored at KGH and then shipped to VUMC for testing. Viral pathogen identification was performed using polymerase chain reaction. Descriptive statistics were used to summarize the pathogens detected.

Results: A total of 502 children were enrolled. Viral pathogens were detected in 376 (75%) children. Of those with viral infections, two or more pathogens were present in 27% (101/376). A total of 488 viruses were detected, with rhinovirus (142, 29%), respiratory syncytial virus (98, 20%), and parainfluenza virus (66, 13.5%) being the three most common. Additionally, 45 (9%) children were diagnosed with influenza and 20 (4%) children with SAR-CoV-2. All 502 children (100%) enrolled in this study received antibiotics.

Conclusions/Learning Points: Following standard clinical protocols designed for resource limited settings, 100% of children admitted with ARI symptoms were prescribed antibiotics. Viral pathogen detection was common, though SAR-CoV-2 was infrequent. In other parts of the world, COVID-19 has impacted the seasonality of common respiratory pathogens. Further studies and laboratory capacity are needed to understand the epidemiology of respiratory viral pathogens in Sierra Leone, including any impact resulting from the ongoing COVID-19 pandemic.

EP290 / #1525

Topic: AS08. Respiratory infections (only non-SARS-CoV2 content) / AS08.a. Viral respiratory infections

LOW RESPIRATORY TRACT INFECTIONS (LRTI) BY RESPIRATORY VIRUSES DURING THE SARS-COV-2 PANDEMIC IN A PEDIATRIC HOSPITAL IN CHILE.

E-Posters

E-POSTER VIEWING

Paulina Silva Toledo¹, Juan Pablo Torres², Lorena Tapia², Jan Wilhelm², Cecilia Pinera²

¹Universidad de Chile, Department Of Pediatrics, Santiago, Chile, ²Hospital de Niños "Dr. Luis Calvo Mackenna, Universidad de Chile, Department Of Pediatrics, Division Of Pediatric Infectious Diseases, Santiago, Chile

Backgrounds: Since the SARS-CoV-2 Pandemic, a decrease in the circulation of respiratory viruses has been observed, there is little data on coinfection viral and the outcome of LRTI. Objective: To determine the frequency and epidemiological-clinical characteristics in children hospitalized with LRTI.

Methods: prospective study, carried out in a Pediatric Hospital in Santiago, Chile, between July 2021 and January 1, 2022, in all children hospitalized for LRTI. Multiplex PCR was obtained for 20 respiratory viruses in a nasopharyngeal sample. Demographic, clinical and treatment variables were evaluated. Chi square and Student's t-test were performed for data analysis. The study was approved by the local ethics committee.

Results: Of 306 episodes of LRTI 272 (89%) had respiratory virus detection. 214 (79%) was a single viral infection. The detection frequency was: 43% RSV, 31% Rhinovirus, 4% other viruses and 1.3% SARS-CoV-2. 56% were male. The average age of the total LRTI was 21.6 months (+28). When comparing the mean age between RSV versus Rhinovirus it was significantly higher for Rhinovirus (11.4 months versus 29.6; $p < 0.05$). Predominantly during spring. The average days of oxygen therapy were 5 days, with no differences by agent. The days of hospitalization were on average 5.6 (RSV) and 4.4 (Rhinovirus), $p < 0.05$. The percentage of admission to the ICU was 8% in the total group, with no differences between RSV and Rhinovirus. There was no mortality.

Conclusions/Learning Points: The respiratory virus circulation during the Pandemic in Chile shifted to the spring-summer period and a higher age of admission was demonstrated in children with LRTI in relation to pre-pandemic times, with no mortality reported in this study

EP291 / #1911

Topic: AS08. Respiratory infections (only non-SARS-CoV2 content) / AS08.a. Viral respiratory infections

BILATERAL PNEUMONIA AND ATELECTASIS IN RIGHT UPPER LOBE FROM MIXED LOWER RESPIRATORY INFECTION WITH RSV, STAPHYLOCOCCUS AUREUS MRSA AND E.COLI IN 1.5M INFANT- CASE REPORT

E-Posters

E-POSTER VIEWING

Olga Smilevska Spasova¹, Gorica Popova², Katerina Boshkovska³, Mirjana Popovska¹, Zorica Sharevska⁴

¹Institute of Respiratory Diseases in Children-Kozle, Pediatrics, Skopje, North Macedonia, ²Institute for respiratory diseases in children, Department For Microbiology, Skopje, North Macedonia, ³Institute for respiratory diseases in children, Department For Tuberculosis, Skopje, North Macedonia, ⁴Institute for respiratory diseases in children, Skopje, North Macedonia, Post Icu, Skopje, North Macedonia

Title of Case: BILATERAL PNEUMONIA AND ATELECTASIS IN RIGHT UPPER LOBE FROM MIXED LOWER RESPIRATORY INFECTION WITH RSV, STAPHYLOCOCCUS AUREUS MRSA AND E.COLI IN 1.5M INFANT- CASE REPORT

Background: Pneumonia is an infection of the pulmonary parenchyma that can be the cause of atelectasis. Atelectasis is an incomplete expansion or complete collapse of air-breathing tissue. Normally, air passes through the airways into the small sacs of the lungs. In Atelectasis oxygen and carbon dioxide cannot pass through the collapsed sacs. Causes of atelectasis in infants are viral infections specifically RSV, bacterial pneumonia, mucus plug, inhaled objects and damage to nerve and muscles that control breathing. Diagnosis: x-ray chest, labs, CT, bronchoscopy.

Case Presentation Summary: Infant 1.5m presents 10 days with low grade fever. At admittance infant is pale, anxious with rapid shallow respirations, cough, dyspnea, cyanosis, O₂Sat 85%, and tachycardia. On auscultation: absent breathing sounds in right upper segment and bilateral coarse crackles. X-ray with homogenous opacity of the right upper lobe suggestive of atelectasis, hyperinflation. CRP 3.9mg/L, PCT <0.05 ng/ml, sputum - Staphylococcus aureus MRSA positive, CerTest Influenza A+B+ RSV- RSV positive, fast antigen test -SARs cov 2 -negative, bronchial aspiration -Escherichia coli positive, serologic IgG for SARS Cov 2 negative, d-dimer -19018, blood coagulation hemostasis: hypercoagulability state with highly activated secondary fibrinolysis. Treatment in ICU: with 3l/min oxygen and i.v antibiotic cefotaxim and amikacin for a duration of 6 days. On day 7 continued with i.v clindamycin by antibiogram, also treated with systemic corticosteroids for 9 days, inhaled bronchodilator for 9days and i.v low density heparin for few days. Control x-ray with evident resolution on day 10.

Learning Points/Discussion: Early diagnosis and appropriate treatment is key in preventing subsequent pulmonary fibrosis.

Topic: AS08. Respiratory infections (only non-SARS-CoV2 content) / AS08.a. Viral respiratory infections

RHINOVIRUS PERSISTENCE DURING THE COVID-19 PANDEMIC – IMPACT ON PEDIATRIC ACUTE WHEEZING ADMISSIONS

E-Posters

E-POSTER VIEWING

Kah Wee Teo¹, Deepa Patel¹, Shilpa Sisodia², Damian Roland³, Erol Gaillard^{1,4}, Julian Tang^{4,5}

¹University Hospitals of Leicester NHS Trust, Paediatric Respiratory Medicine, Leicester, United Kingdom, ²Leicester City Council, Public Health, Leicester, United Kingdom, ³University Hospitals of Leicester NHS Trust, Children Emergency's Department, Leicester, United Kingdom, ⁴University of Leicester, Respiratory Sciences, Leicester, United Kingdom, ⁵University Hospitals of Leicester NHS Trust, Clinical Microbiology, Leicester, United Kingdom

Backgrounds: Rhinovirus transmission is now considered to be mostly airborne, and has thus persisted throughout the COVID-19 pandemic, despite other seasonal respiratory viruses (influenza, parainfluenza, respiratory syncytial virus, adenoviruses, human metapneumovirus) being mostly suppressed by pandemic restrictions, such as masking and other forms social distancing.

Methods: In this retrospective observational study, data was extracted on all children (aged 0-18 years) that presented to the pediatric emergency department (PED) during January 2018 to December 2020, who were coded as 'asthma' or 'viral induced wheeze'. Age, ethnicity, gender, and clinical outcomes were extracted from hospital databases. Contemporaneous air quality index (AQI) data was also obtained from government environmental databases, as the monthly mean of the two main pollutants: particulate matter $\leq 2.5 \mu\text{m}$ and $\leq 10 \mu\text{m}$ in diameter ($\text{PM}_{2.5}$ and PM_{10}).

Results: The Figure shows that the percentage of PED admissions for acute wheezing in 2020 were very similar to those in 2018-2019 in the same months – except for April-July 2020, where the proportion of PED admissions for acute wheezing dropped substantially to 15-30% compared to the more usual 50-60% in previous non-pandemic years. In contrast, the levels of airborne environmental particulates ($\text{PM}_{2.5}$ and PM_{10}) did not vary significantly during this same period. Although our local virology laboratory ceased routine testing for seasonal respiratory viruses during this period to cope with the SARS-CoV-2 testing, national sentinel surveillance laboratory testing continued. This showed an ongoing, fluctuating incidence of rhinovirus, which was relatively low during April-July 2020.

Figure 1: Monthly percentage of paediatric emergency department (PED) presentations due to acute wheezing during 2018 to 2020. The box defined by the dashed line indicate a period in 2020 (April-July) when the percentage of cases admitted for acute wheezing decreased substantially compared to the same months in year 2018-2019.

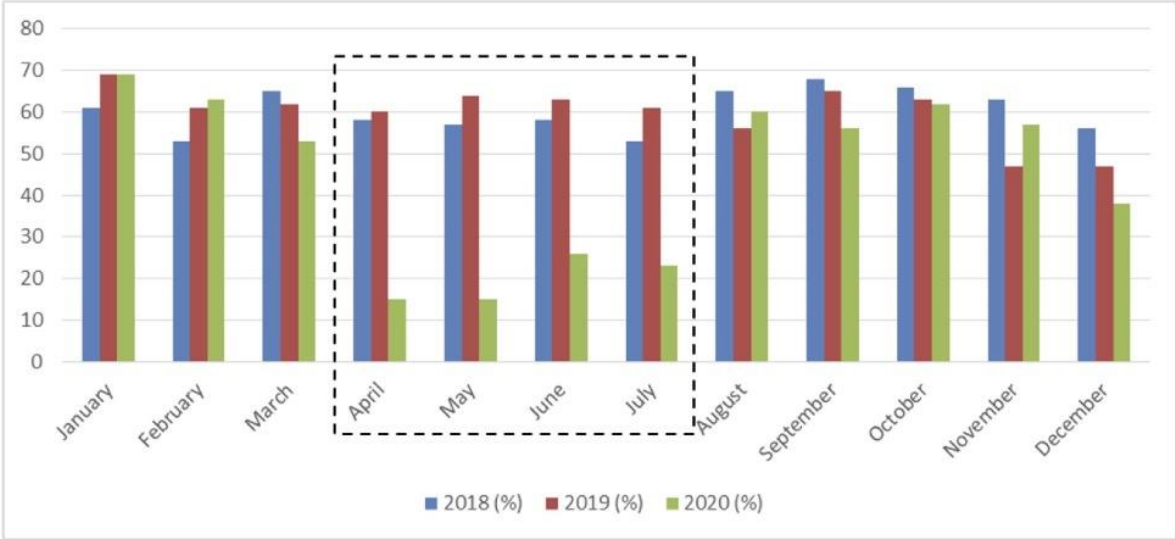

Conclusions/Learning Points: Remarkably, despite the widespread disruption to the seasonality, routine laboratory testing and surveillance of these respiratory viruses resulting from the COVID-19 pandemic, this study indicates that rhinoviruses are still the main cause of pediatric wheezing presentations seen in PED.

EP293 / #999

Topic: AS08. Respiratory infections (only non-SARS-CoV2 content) / AS08.a. Viral respiratory infections

AN ONGOING OUTBREAK OF ENTEROVIRUS D68 IN LEICESTER, UNITED KINGDOM SINCE SEPTEMBER 2021

E-Posters

E-POSTER VIEWING

Oliver Toovey¹, Nahed Elhefnawy¹, Muhammad Fahad¹, [Kah Wee Teo](#)², Julian Tang^{1,3}

¹University Hospitals of Leicester NHS Trust, Department Of Microbiology, Leicester, United

Kingdom, ²University Hospitals of Leicester NHS Trust, Paediatric Respiratory Medicine, Leicester, United

Kingdom, ³University of Leicester, Respiratory Sciences, Leicester, United Kingdom

Backgrounds: Enterovirus EV D68 along with EV A71 are both causes of childhood hand-foot-and-mouth disease (HFMD), but have also both been associated with severe neurological complications, such as acute flaccid paralysis (AFP). Some have suggested that these two viruses may be filling in the niche vacated by the polio viruses, which have mostly been eradicated globally. In recent years, cases of AFP linked to EV D68 have been reported from the USA, Norway, France, Scotland, Spain and elsewhere. With the lifting of COVID-19 pandemic restrictions there has been a resurgence of EV D68 across Europe, but so far with no reported cases of AFP.

Methods: We report on an ongoing outbreak of enterovirus D68 infections in children between 1 month and 14 years of age admitted to a large teaching hospital in Leicester, United Kingdom.

Results: There has been a male predominance (77%) in these children with 53% of children presenting aged under 1 year old. The first case was detected in September 2021 (Week 37) with a large number of cases following leading to a peak in November 2021. Most presented with mild respiratory illness with an average length of stay of 2.9 days. A few children developed more severe disease however with 3 patients requiring PICU support, and 2 patients dying, although it is not yet known to what degree enterovirus D68 contributed to these deaths. 16 children had significant comorbidities, such as chronic lung disease of prematurity or asthma. Figure 1: An epidemiological curve showing the number of cases of confirmed enterovirus D68 by sequencing per week between September and December 2021

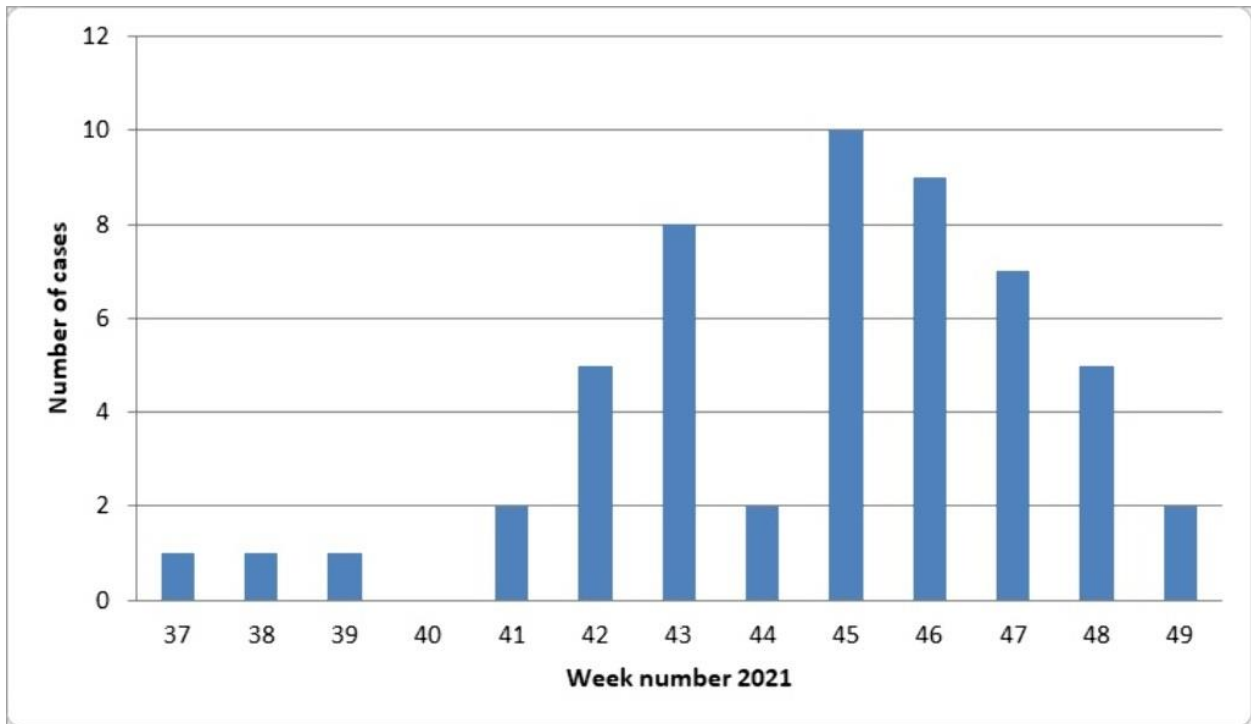

Conclusions/Learning Points: No neurological complications have been identified, though the outbreak is still ongoing in the community.

EP294 / #1247

Topic: AS08. Respiratory infections (only non-SARS-CoV2 content) / AS08.a. Viral respiratory infections

RSV BRONCHIOLITIS IN NEONATES DURING COVID-19 PANDEMIC

E-Posters

E-POSTER VIEWING

Maria Tsirigotaki¹, Fani Ladomenou², Emmanouil Chatzakis¹, Michael Papadimas¹, Maria Theodoraki¹, Marina Koropouli¹

¹Venizeleion General Hospital, Neonatal Intensive Care Unit, Heraklion, Crete, Greece, ²Venizeleion General Hospital, Pediatrics, Heraklion, Crete, Greece

Backgrounds: SARS-CoV-2 public health measures contributed to a significant shift in transmission of respiratory viruses including respiratory syncytial virus (RSV). Aim of this study was to examine the epidemiology of RSV infections in neonates and compare clinical characteristics before and after coronavirus disease pandemic (COVID).

Methods: Cohort study of neonates aged less than 30 days admitted in hospital with PCR confirmed RSV bronchiolitis from January 2016 till December 2021. For RSV-positive admissions, demographics and clinical features were compared. Criteria for admission included respiratory distress, hypoxemia, poor feeding, or dehydration.

Results: A total of 44 neonates were admitted with RSV bronchiolitis over a 6- year period (mean age 18,7days; range 9-30days). After a relative absence during COVID quarantine, we observed an increase in RSV bronchiolitis cases in 2021 and an unexpected early peak of RSV bronchiolitis admissions in September-October, 11-times higher than in previous years; [Period B: (2020-2021) vs Period A (2016-2019); OR 11 (1.21-99.2)]. Disease severity did not differ in terms of length of stay, need for mechanical or non-invasive ventilation during the two periods. No deaths occurred.

Conclusions/Learning Points: Following the first wave of COVID, we observed a non-seasonal peak in RSV cases that could be attributed to the relaxation of the nonpharmaceutical interventions for the containment of SARS-CoV-2, as well as a significantly expanded cohort of RSV- naive siblings and parents due to the previous lockdown.

EP295 / #939

Topic: AS08. Respiratory infections (only non-SARS-CoV2 content) / AS08.a. Viral respiratory infections

CLINICAL FEATURES OF MEASLES IN CHILDREN UNDER 3 YEARS

E-Posters

E-POSTER VIEWING

Alina Zaretska, Yuriy Kharchenko, Hanna Pitel

Odessa National Medical University, Children Infection Diseases, Odesa, Ukraine

Backgrounds: Outbreaks appear to be exacerbated during periods of low vaccination coverage. In Ukraine in 2016, the level of vaccinations with the first dose was only in 45% of children, and the second - in 31%. Thus, during 2017 only in the Odessa region, the number of measles patients reach 1,016.

Methods: A retrospective study of the medical histories of 111 young children, 68 of them in the first year of life, was conducted on the basis of the City Clinical Infectious Diseases Hospital.

Results: The course of measles in infants and children 1-3 years typically manifests with acute onset, intoxication 71.82%, fever 99.09%, cough 94.55%, catarrhal phenomena, and exanthema. At the same time, rhinorrhea (95.59%) and puffiness (100%) are characterized infants compared to children 1-3 years (51.16% and 58.14%, respectively), $p < 0.001$.

The severity of measles depends on age. Thus, among children younger than 12 months, the severe disease was 35.29% more common than among children aged 1-3 years, and among children less than 6 months, the severe course was observed in 55.62%.

Complications, mainly in the form of pneumonia (32.35% of infants and 16.28% of 1-3 years) and bronchitis (4.41% (up to 12 months) and 18.6% (12-36 months)) were observed in 44.14% of children with measles. Also, among the complications were aphthous stomatitis (1.47% of infants and 9.3% of children 1-3 years); otitis media 7.35%, only in children less than 12 months, and rhinosinusitis 2.33% and hypochromic anemia 2.33% - in children aged 1-3 years.

Conclusions/Learning Points: Thus, the clinical manifestations, severity, and complications of measles depend on the age of the child, and the presence of children less than 6 months (28.81%) indicates the existence of a non-immune layer among women of childbearing age.

EP296 / #827

Topic: AS08. Respiratory infections (only non-SARS-CoV2 content) / AS08.b. Bacterial pneumonia

EVALUATING WHETHER COMMUNITY HEALTH WORKERS CAN SUCCESSFULLY RECORD LUNG SOUNDS FROM CHILDREN IN BANGLADESH USING A DIGITAL STETHOSCOPE

E-Posters

E-POSTER VIEWING

Salahuddin Ahmed¹, Harish Nair², Steve Cunningham³, Abdullah Baqui⁴, Eric Mccollum⁵

¹Projahnmo Research Foundation, Research, Dhaka, Bangladesh, ²Usher Institute, Edinburgh medical School, University of Edinburgh, Centre For Global Health, Edinburgh, United Kingdom, ³University of Edinburgh, Centre For Inflammation Research, Edinburgh, United Kingdom, ⁴Johns Hopkins Bloomberg School of Public Health, International Health, MD, United States of America, ⁵Johns Hopkins University, Eudowood Division Of Pediatric Respiratory Sciences, Department Of Pediatrics, MD, United States of America

Backgrounds: The diagnostic performance of IMCI guidelines for child pneumonia may be improved by including lung auscultation. Although it is challenging for frontline healthcare workers to effectively use a conventional acoustic stethoscope, a digital stethoscope enhanced with an automated lung sound classification algorithm may be feasible. We aimed to evaluate whether government Community Health Workers (CHWs) in rural Bangladesh can effectively record quality lung sounds from under-5 children.

Methods: Government CHWs recorded lung sounds from four chest positions using a novel digital stethoscope in under-5 children with cough and/or difficult breathing at first-level clinics in rural Bangladesh from November 2019 to December 2020. A paediatric listening panel trained to a standardized interpretation protocol classified the recorded sounds. A quality recording was defined a priori as a child with three of four chest positions assessed as interpretable by the listening panel. An interpretable chest position was classified by the listening panel as any of the following: no wheeze and no crackle, wheeze only, crackle only, or wheeze and crackles.

Results: A total of 990 children were enrolled out of 2434 screened. The listening panel classified 867 children as having a quality recording (87.6%; 95% CI: 85.4%, 89.6%). CHWs recorded 75.7% (656/867) of quality recordings within three minutes.

Conclusions/Learning Points: This study demonstrates government CHWs at rural, first-level clinics in Bangladesh are capable of recording quality lung sounds from most children using a novel digital stethoscope. The findings suggest CHWs can feasibly use digital auscultation without a substantial increase in their workload.

EP297 / #599

Topic: AS08. Respiratory infections (only non-SARS-CoV2 content) / AS08.b. Bacterial pneumonia

METABOLOMICS DIFFERENTIATES CHILDREN WITH COMMUNITY-ACQUIRED PNEUMONIA FROM CONTROLS USING METABOLOMICS

E-Posters

E-POSTER VIEWING

Lilliam Ambroggio¹, Todd Florin², Kayla Williamson¹, Brandie Wagner¹, Larisa Yeomans³, Heidi Sucharew⁴, Maurizio Macaluso⁴, Richard Ruddy⁴, Kathleen Stringer³, Samir Shah⁴

¹Children's Hospital Colorado, Pediatrics, Aurora, United States of America, ²Lurie Children's Hospital, Pediatrics, Chicago, United States of America, ³University of Michigan, Pharmacy, Ann Arbor, United States of America, ⁴Cincinnati Children's Hospital Medical Center, Pediatrics, Cincinnati, United States of America

Backgrounds: The diagnosis of pediatric community-acquired pneumonia (CAP) can be challenging. Most physical examination findings are non-specific and chest radiograph findings are not consistently reliable. Biomarkers identified by metabolomics may help identify CAP in children. The objective is to assess the utility of metabolomics to distinguish children with suspected pediatric CAP from healthy controls.

Methods: Children, 3 months to 12 years old, with emergency department visits for suspected CAP (cases) were compared with age and sex-matched community healthy controls. Urine was collected via cotton balls in a diaper or cup. Nuclear magnetic resonance spectrometry was used to identify and quantify metabolites. A random forest approach evaluated three models discriminating cases from controls based on: 1) clinical signs and symptoms; 2) metabolites, and 3) the combination of both. The area under the receiver operating characteristic curve (AUC) was computed for each model. In a sensitivity analysis, only cases with radiographic CAP (i.e., focal opacity) were compared with the controls.

Results: Of 252 cases and 122 controls, 87% were 1-12 years old. The combination of clinical signs and symptoms and metabolites had the best accuracy across all models (Figure, AUC: 1.0). The important discriminating factors were fever, difficulty breathing, cough, prior corticosteroid use, rapid breathing, noisy breathing, abnormal sleep, citrate, 1-methylnicotinamide, and trigonelline. The radiographic CAP model included fever, ethanolamine, hypoxanthine, trigonelline, 1-methylnicotinamide, acetylcarnitine, creatinine, fumarate, and ascorbate (AUC: 0.99).

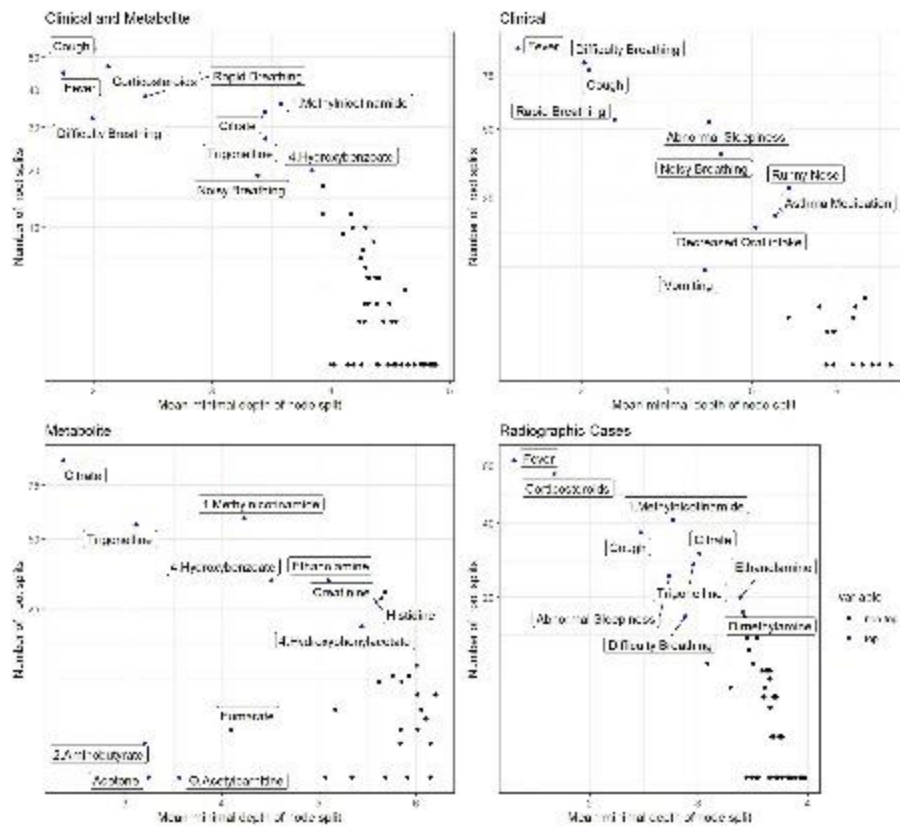

Figure Legend. Multiway importance plot based on the mean minimal depth of the Gini index and the number of times a tree was split based on each random forest model. An important variable will have a low mean minimal depth and be included in many tree splits.

Conclusions/Learning Points: Metabolites in combination with clinical characteristics accurately discriminated controls from children with suspected CAP. Identification of metabolites associated with CAP is a critical first step in identifying novel biomarkers for CAP diagnosis and management.

EP298 / #1887

Topic: AS08. Respiratory infections (only non-SARS-CoV2 content) / AS08.b. Bacterial pneumonia

THE IMPACT OF COVID-19 PANDEMIC ON THE INCIDENCE AND SEVERITY OF COMMUNITY ACQUIRED PNEUMONIAS IN CHILDREN

E-Posters

E-POSTER VIEWING

Maria Koliou^{1,2}, [Athina Aristidou](#)², Maria Argyrou², Stella Mazeri³

¹University of Cyprus, Medical School, Nicosia, Cyprus, ²Archbishop Makarios Hospital, Paediatrics, Nicosia, Cyprus, ³University of Edinburgh, Roslin Institute, Royal (Dick) School Of Veterinary Medicine, Edinburgh, United Kingdom

Backgrounds: During the first year of the pandemic strict non-pharmacological interventions (NPIs) employed, resulted in a substantial fall in the incidence of respiratory tract infections such as bronchiolitis and pneumonia. However, after the relaxation of these measures some of these infections have returned. This study investigates the effect of the pandemic on the incidence and severity of community-acquired pneumonias (CAPs) in children.

Methods:: CAPs in children admitted to Archbishop Makarios hospital between 1 March 2016 and 28 February 2022 were studied in terms of numbers, severity and age of the patient. These characteristics were compared between the 1stpandemic year (1 March 2020 to 28 February 2021), the 2ndpandemic year (1 March 2021 to 28 February 2022), and the four years before the pandemic ie 2016-17, 2017-18, 2018-19, 2019-20.

Results: The mean annual number of admissions in the pre-pandemic years was 32 and it dropped to 11 during the 1styear of the pandemic. However, admissions increased again in the second year of the pandemic to 40, an increase by 24%. The proportion of complicated pneumonias over total number of cases, approximately doubled, from 19% in the pre-pandemic years to 36% in the 2ndpandemic year (Fisher's exact p-value 0.044). The median age of children was significantly lower during the 2ndyear of the pandemic, compared with the pre-pandemic years (Mann-Whitney p-value 0.01).

Conclusions/Learning Points: NPIs appeared to have decreased the incidence of pneumonias observed in children during the 1stpandemic year. However, during the 2ndpandemic year, an increase in the numbers and severity of pneumonias were noted. This could possibly be attributed to the re-opening of schools. An increased population susceptibility has been proposed which could explain for the decreased patient age during the second year of the pandemic.

EP299 / #756

Topic: AS08. Respiratory infections (only non-SARS-CoV2 content) / AS08.b. Bacterial pneumonia

TWO CASES OF BACTERIAL PNEUMONIA COMPLICATED WITH PLEURAL EMPYEMA

E-Posters

E-POSTER VIEWING

Afroditi Barmpakou, Athanasia Tragomalou, Daphne-Victoria Sidiropoulou, Stavroula-Zoi Siska, Konstantinos Kakleas, Antina Santou, Eirini Orfanou
Aghia Sophia Children's Hospital, First Department of Pediatrics, General Paediatrics, Athens, Greece

Title of Case: TWO CASES OF BACTERIAL PNEUMONIA COMPLICATED WITH PLEURAL EMPYEMA

Background: Pleural empyema is a significant complication of bacterial pneumonia. We describe two cases of bacterial pneumonia accompanied by pleural effusion.

Case Presentation Summary: The first case involves an eight-month-old male who presented with a ten-day history of coryza, a five-day history of low grade fever and gradually worsening respiratory distress. On admission, he was febrile (up to 39.8oC), with raised inflammatory markers. The CXR and pleural ultrasound revealed right middle and lower lobe consolidation and large right pleural effusion with septa. The patient was treated with cefotaxime and clindamycin and chest drain was inserted. He deteriorated clinically on the fifth day of admission and a CT chest revealed an air cavity on the right middle and lower lobe, which resulted in another chest drain insertion. The antibiotic treatment was switched to piperacillin-tazobactam and linezolid. Staphylococcus aureus grew from the pleural fluid culture. The pleural fluid film array showed Staphylococcus aureus and RSV. The patient was discharged after having completed 21 days of intravenous antibiotic therapy. The second case describes a five-year-old female who was transferred to the hospital with right middle lobe pneumonia and empyema for further management. She had one-month-history of coryza and one-week history of high fever and abdominal pain. On admission, she was in poor condition and had raised inflammatory markers. Thoracotomy, decortication and insertion of two chest drain tubes were performed. In pleural fluid film array, Streptococcus pneumoniae was detected. She was discharged after having received 2 weeks of intravenous antibiotics (vancomycin and meropenem/cefotaxime) with plan to continue oral amoxicillin for another 2 weeks.

Learning Points/Discussion: Pleural empyema is an unusual complication of bacterial pneumonia. Prompt recognition and appropriate management will result in good prognosis.

EP300 / #1257

Topic: AS08. Respiratory infections (only non-SARS-CoV2 content) / AS08.b. Bacterial pneumonia

PNEUMOCOCCAL SEROTYPE DISTRIBUTION IN HEALTHY CHILDREN ATTENDING DAY-CARE CENTRES IN PANDEMIC TIMES: THE 6TH PERIOD OF THE BELGIAN NASOPHARYNGEAL CARRIAGE STUDY

E-Posters

E-POSTER VIEWING

Esra Ekinci¹, Stefanie Desmet², Liesbet Van Heirstraeten³, Christine Lammens³, Jan Verhaegen², Herman Goossens³, Pierre Van Damme¹, Philippe Beutels⁴, Surbhi Malhotra-Kumar³, Laura Willen¹, Heidi Theeten¹

¹University of Antwerp, Vaccine And Infectious Disease Institute - Centre For Evaluation Of Vaccination, Wilrijk, Belgium, ²University Hospitals Leuven, Medical Microbiology, Leuven, Belgium, ³University of Antwerp, Laboratory Of Medical Microbiology, Wilrijk, Belgium, ⁴University of Antwerp, Centre For Health Economics Research And Modelling Infectious Diseases, Wilrijk, Belgium

Backgrounds: Following a switch in 2016 from a 13-valent (PCV13) to a 10-valent pneumococcal conjugate vaccine (PCV10) in the infant vaccination program, our group started monitoring nasopharyngeal carriage of pneumococcal serotypes (STs) in Belgian children (6-30 months) attending day-care centres (DCC). In September 2019, the program switched back to PCV13. Here we report data collected during the sixth (P6, November 2020-June 2021) and fifth study period (P5, November 2019-July 2020). Children were also screened for the presence of SARS-COV-2.

Methods: In P6, 700 of the 907 collected nasopharyngeal swab samples were cultured to detect *Streptococcus pneumoniae* (SP). Serotyping by Quellung reaction and antimicrobial susceptibility testing (penicillin, tetracycline, erythromycin, cotrimoxazole and levofloxacin) of SP were performed. In 746/907 children a second sample was obtained and screened for SARS-CoV-2 by real-time PCR. Child vaccination status was collected and differences in pneumococcal carriage between P5 and P6 were evaluated using Chi².

Results: Most children in P6 were either fully vaccinated with PCV13 (39.2%) or received a mixed vaccination schedule (40.1%). Analogous to P5, 481/700 children carried SP (67.5% (P5)); 68.7% (P6)) However, carriage of PCV13-vaccine serotypes decreased significantly from 17.3% in P5 to 8.1% in P6 ($p < 0.001$), with the only remaining serotypes being 3, 19A, and 19F. On the contrary, carriage of frequently-occurring non-vaccine serotypes, such as 6C, 10A, 11A, and 15B, did not change whereas serotype 23B increased significantly from 15.2% (P5) to 21.6% (P6) ($p < 0.05$). Also, non-susceptibility of SP-strains to at least one antibiotic increased (41.8% (P5); 70.9% (P6)) ($p < 0.001$). None of the children tested positive for SARS-CoV-2.

Figure 1: Frequency of vaccine and the predominant non-vaccine serotypes in period 5 and period 6.

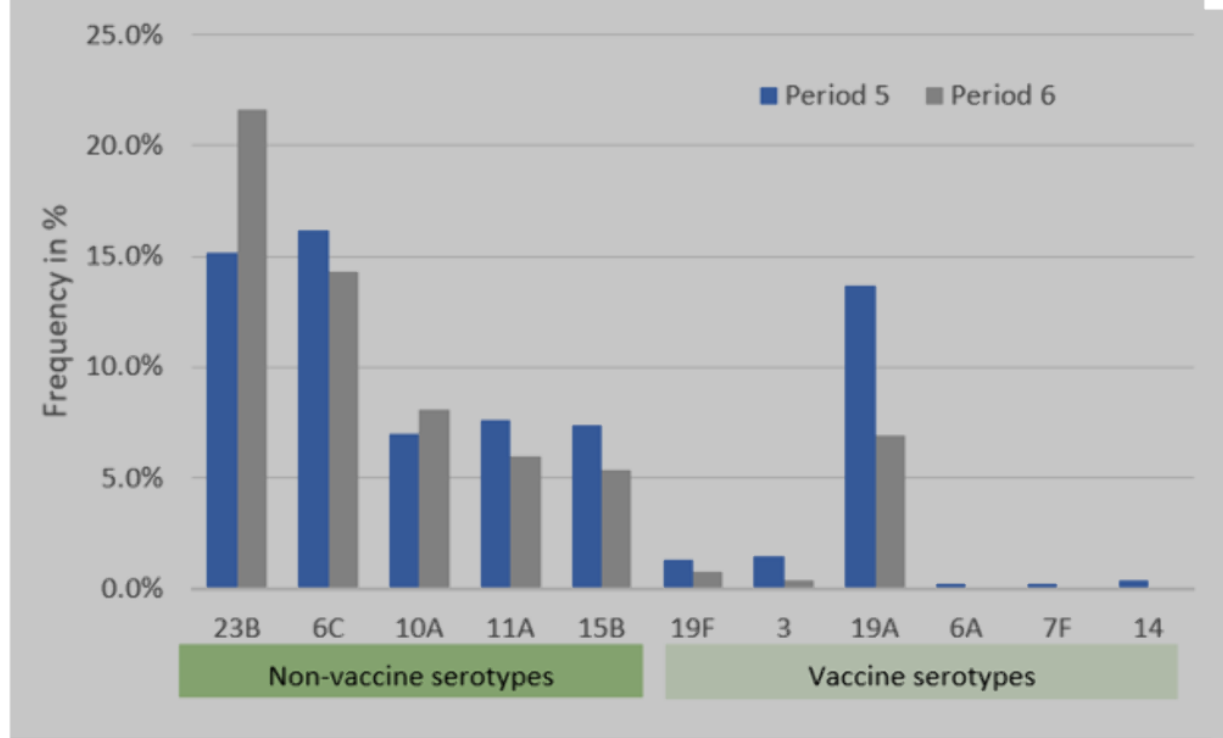

Frequency of non-vaccine serotypes 23B, 6C, 10A, 11A, and 15B and of vaccine serotypes 19F, 3, 19A, 6A, 7F, and 14 in period 5 (blue bars) and in period 6 (grey bars).

Conclusions/Learning Points: In DCC-attending Belgian children, overall carriage of PCV13-vaccine serotypes halved two years after the most recent vaccine switch, while carriage of the non-vaccine serotype 23B increased significantly.

EP302 / #1418

Topic: AS08. Respiratory infections (only non-SARS-CoV2 content) / AS08.b. Bacterial pneumonia

PARAPNEUMONIC PLEURAL EFFUSIONS IN THE LAST 10 YEARS - A LEVEL II HOSPITAL RESTROSPECTIVE STUDY

E-Posters

E-POSTER VIEWING

Ana Sofia Figueiredo, Inês Rodrigues, Sandra Pereira, Joana Carvalho, Cristina Cândido
Centro Hospitalar de Trás os Montes e Alto Douro, Paediatrics, Vila Real, Portugal

Backgrounds: Pneumonia occasionally progresses to parapneumonic effusion or noncomplicated exudate. Effusions are mainly associated with bacterial infections, but other agents, such as viruses and mycobacteria, may be involved.

Methods: We conducted a retrospective descriptive analysis of hospitalized patients with pleural effusion (2012-2021), using SPSS®.

Results: We studied 17 children, 12 males with a median age of 5 years (1–17), 1 with global developmental delay. Nearly half cases occurred during winter and patients referred a median symptoms evolution of 4 days. At presentation, cough (94%), fever (88%) and thoracic pain (53%) were the main complaints. Median C-reactive protein was 7,7 mg/dl and mean white blood cells count was 13930/uL. Chest radiograph identified small volume pleural effusion in 9 patients, moderate in 6 and large in 2. Ultrasonography was performed in 7 patients, identifying septations in 3. Thoracentesis was executed in 8 patients and pleural fluid analysis classified it as exudate (5), empyema (2) and transudate (1). S.pneumonia was identified in 2 blood cultures, Varicella Zooster virus in 1 pleural fluid and tuberculin skin test was positive in another patient. Antibiotic monotherapy (beta-lactams and beta-lactamase inhibitors) was performed in 7 patients and the remaining were treated with combined therapy, for a mean of 16,4 days. Pleural fibrinolytics were administered in 4 cases. Mean hospitalization time was 12 days, 2 patients were transferred (intensive care unit and cardiothoracic surgery) and 1 patient, with severe comorbidities, died. Radiographic abnormalities persisted longer in empyema.

Conclusions/Learning Points: This study highlights the clinical severity of moderate and large volume pleural effusions. The main limitations were the small sample size and the lack of antibiotic uniformity. The scientific advances allowing agents identification through polymerase chain reaction in pleural fluid, will improve diagnosis and treatment.

EP303 / #1055

Topic: AS08. Respiratory infections (only non-SARS-CoV2 content) / AS08.b. Bacterial pneumonia

CRITICAL PERTUSSIS CASES IN PICU

E-Posters

E-POSTER VIEWING

Maia Kherkheulidze¹, Tika Kutubidze¹, Pikria Lursmanashvili¹, Gia Bibilashvili², Ana Iakobashvili³, Dodo Kartvelishvili³

¹State Medical University, Pediatrics, Tbilisi, Georgia, ²Clinic "Jerarsi", Intensive Care Unit, Tbilisi, Georgia, ³G. Jvania Pediatric Academic Clinic, Intensive Care Unit, Tbilisi, Georgia

Title of Case: Critical pertussis cases in PICU

Background: Despite high coverage of vaccination with the hexavalent vaccine in Georgia (98,5 %) there still remain severe cases of pertussis, that need critical care and have a high mortality rate. The aim of our study was to evaluate a patient's history with critical pertussis and determine risk factors associated with poor outcomes.

Case Presentation Summary: Retrospective study was conducted analyzing cases of patients admitted in 2 tertiary pediatric clinics from 1/11/19 to 1/12/20 with diagnosis of pertussis. The study involved the cases of pertussis in PICU, with standard case presentation (paroxysmal cough, inspiratory whoop, post tussive emesis, apnea and/or cyanosis) and positive PSR test. Patients demographic and clinical data, duration of illness and date of admission, comorbid factors, lab tests, radiological data and outcome were analyzed. Results: At all 11 patient's clinical records were analyzed. 4 patients were unimmunized and 5 have only one dose of vaccine. During admission main presentation was respiratory failure, 1 patient was admitted with seizures and 1 patient with shock. From 11 patients, mean age 7+ 4 months, 72,7 % (n=8) were on mechanical ventilation and 45,4% (n=5) need exchange transfusion due to high leucocyte level more than 50 x10⁹/L and 1 patient need ECMO therapy. The mortality rate was 27, 2 % (n=3). The study showed that shock, altered mental status, small age and high leucocyte level as well as the delayed blood exchange in patients with high leucocyte level were associated with poor outcome.

Learning Points/Discussion: Critical pertussis is more common in early infancy, small age as well as delayed blood exchange, low Glasgow score can be considered as predictor factors for poor outcome.

EP304 / #916

Topic: AS08. Respiratory infections (only non-SARS-CoV2 content) / AS08.b. Bacterial pneumonia

SPONTANEOUS TENSION PNEUMOTHORAX IN TEENAGE BOY WITH ATYPICAL RISK FACTORS

E-Posters

E-POSTER VIEWING

Paula Madrid Garcia¹, Ana Maria Perez Benito¹, Valenti Pineda Solas², Oscar Asensio De La Cruz¹, Romina Conti²

¹Consorti Sanitari Parc Tauli, Paediatrics, Sabadell, Spain, ²Consorti Sanitari Parc Tauli, Paediatrics Hospitalization And Infectious Diseases., Sabadell, Spain

Title of Case: SPONTANEOUS TENSION PNEUMOTHORAX IN TEENAGE BOY WITH ATYPICAL RISK FACTORS

Background: Pneumothorax can be common in previously healthy adolescents. Primary spontaneous is the most frequent in adolescents. Asma, tobacco, congenital anomalies and a slim constitution are some typical risk factors.

Case Presentation Summary: An obese 13 -year-old boy consulted in emergency department for respiratory distress and sudden onset chest pain, without fever, cough or history of trauma. Background of obstructive sleep apnea (OSA) and intellectual disability. Left hypophonesis was observed. X-ray showed left pneumothorax with collapsed lung. Blood tests with leukocytosis ($19.9 \times 10^9/L$), neutrophilia ($13.30 \times 10^9/L$) and CRP of 5mg/dl. Diagnosis of pneumothorax was done and a pleural tube was placed. Increased respiratory distress and fever appeared. Control X-ray showed a condensation in the left lower lobe and CRP increased to 25mg/dl. Ceftriaxone, clindamycin and azithromycin were started. Reviewing the medical history suggested a 7-day history of chest pain and cough. Work-up showed Mycoplasma serology (negative), nasopharyngeal aspirate (Rhino-enterovirus positive), Pneumococcal urine antigen (negative) and cultures of sputum (negative). Progressive deterioration continued and increased oxygen therapy needed. Ecography showed 4.8cm pleural effusion. New pleural tube was placed: pleural fluid was compatible with exudate with negative cultures. Clinical improvement was seen with decreased pleural effusion, consolidation and CPR. Received 14 days of intravenous antibiotic and 14 days of oral amoxicillin-clavulanic. At discharge, suspicion of pneumothorax due to necrotic pneumonia secondary to anaerobic bacteria. Positive pleural fluid PCR for *Fusobacterium nucleatum* and *Streptococcus intermedius* was reported, supporting our hypothesis of necrotizing anaerobic pneumonia in a patient with atypical risk factors (obesity, OSA, intellectual disability and probably microaspirations).

Learning Points/Discussion: Pneumothorax can be an atypical presentation of necrotizing pneumonia. Anaerobic bacteria such as *Fusobacterium* can cause necrotizing pneumonia. Good anamnesis is necessary to find associated risk factors.

Topic: AS08. Respiratory infections (only non-SARS-CoV2 content) / AS08.b. Bacterial pneumonia

EVOLUTION OF INVASIVE PNEUMOCOCCAL DISEASE AMONG ANDALUSIAN CHILDREN AFTER THE INTRODUCTION OF PCV13 UNIVERSAL CHILDHOOD VACCINATION

E-Posters

E-POSTER VIEWING

Beatriz De Felipe¹, Marta Aboza García¹, Pablo Obando Pacheco², Begoña Carazo³, David López Martín⁴, Juan Luis Santos Pérez⁵, Chere Muñoz⁶, Verónica González Galán⁷, Juan Antonio Cordero Varela⁸, Olaf Neth⁶, Ignacio Obando Santaella¹

¹IBIS, Pediatric Infectious Diseases, Rheumatology And Immunology Unit, Sevilla, Spain, ²Hospital de la Merced, Pediatric Unit, Osuna, Spain, ³Hospital Regional de Málaga, Pediatric Infectious Disease Unit, Málaga, Spain, ⁴Hospital Costa del Sol, Pediatric Unit, Málaga, Spain, ⁵Hospital Virgen de las Nieves, Pediatric Unit, Granada, Spain, ⁶Hospital Universitario Virgen del Rocío, Pediatric Infectious Diseases, Rheumatology And Immunology Unit, Sevilla, Spain, ⁷Hospital Universitario Virgen del Rocío, Microbiology Department, Sevilla, Spain, ⁸IBIS, Ibis, Sevilla, Spain

Backgrounds: AIM: To assess the impact of the introduction of the 13-valent pneumococcal conjugate vaccine (PCV13) universal vaccination program in December 2016 on the epidemiology of invasive pneumococcal disease (IPD) in children from Andalusia.

Methods: Population-based prospective surveillance study on all laboratory confirmed cases of IPD in children <14 years old from three selected provinces in Andalusia (Granada, Malaga and Seville) between January 2018 and December 2020. An historical collection of 75 isolates collected from paediatric patients with IPD in Hospital Virgen del Rocío (Seville) and Carlos Haya (Malaga) during the 2006-2009 period were used as pre-PCV13 historical controls for comparison of serotype distribution.

Results: Overall IPD incidence rate was 3.40 cases per 100.000 in 2018, increased non significantly to 4.53 cases per 100.000 in 2019 and was 51% lower in 2020 (2.21 cases per 100000; incidence rate ratio 0.49, 95% CI 0.25- 0.97). Proportion of IPD cases due to PCV13 serotypes declined significantly in 2018-2020 compared with historical controls (22% vs 93%; P=0.0001). Serotypes 24 (17%), 11A (9%) and 22F (9%) were the most frequently identified non-PCV13 serotypes (NVT) during 2018-2020 and their prevalence increased significantly between time periods. There were differences in invasive potential and clonal dynamics among these NVT. Penicillin- and/or ampicillin-resistant clones belonged to the CC156 (serotype 14-ST156 and serotype 14-ST2944 and serotype 11A-ST6521).

Conclusions/Learning Points: The proportion of IPD cases due to PCV13 serotypes declined significantly in 2018-2020 after initiation of a PCV13 universal vaccination program in 2016 due to PCV13. However, and overall concerning, certain NVT such as serotypes 24, 22F and 11a warrants future monitoring in IPD due to invasive potential and/or antibiotic resistance rates.

Topic: AS08. Respiratory infections (only non-SARS-CoV2 content) / AS08.b. Bacterial pneumonia

MULTIDISCIPLINARY INTERVENTIONS TO DECREASE CHEST X-RAY USE IN PEDIATRIC COMMUNITY ACQUIRED PNEUMONIA

E-Posters
E-POSTER VIEWING

Abdul Mannan Mustafa¹, Ghulam Mustafa²

¹Helping Hands Foundation, Research, Multan, Pakistan, ²Nishtar Hospital & University, Multan, Head Of Pediatric Medicine, Multan, Pakistan

Backgrounds: Worldwide, biggest killer of children under 5 years of age, is pneumonia. The clinicians use chest x-ray for diagnosing and following it up against the guidelines and consequent hazards. We collaborated with American Academy of Pediatrics initiative of Value in inpatient pediatrics (VIP) Improving Community Acquired Pneumonia (ICAP) Quality improvement project to change the paradigm. Objectives: To decrease the use of chest x-ray to 10% for initial diagnosis and to decrease the use of follow up chest x-ray to less than 10% in inpatients in under 5 age group.

Methods: We implemented series of interventions including information dissemination, interactive discussions and webinars with all care providers. The rates of chest x-ray use were determined by individual chart review at baseline and then over 5 improvement cycles. The Baseline percentages were compared with the final cycle using Fisher's exact test.

Results: Rates of chest x-ray use decreased for initial diagnosis from 100% to 50% and rate of follow up chest x-ray decreased more than the set goal.

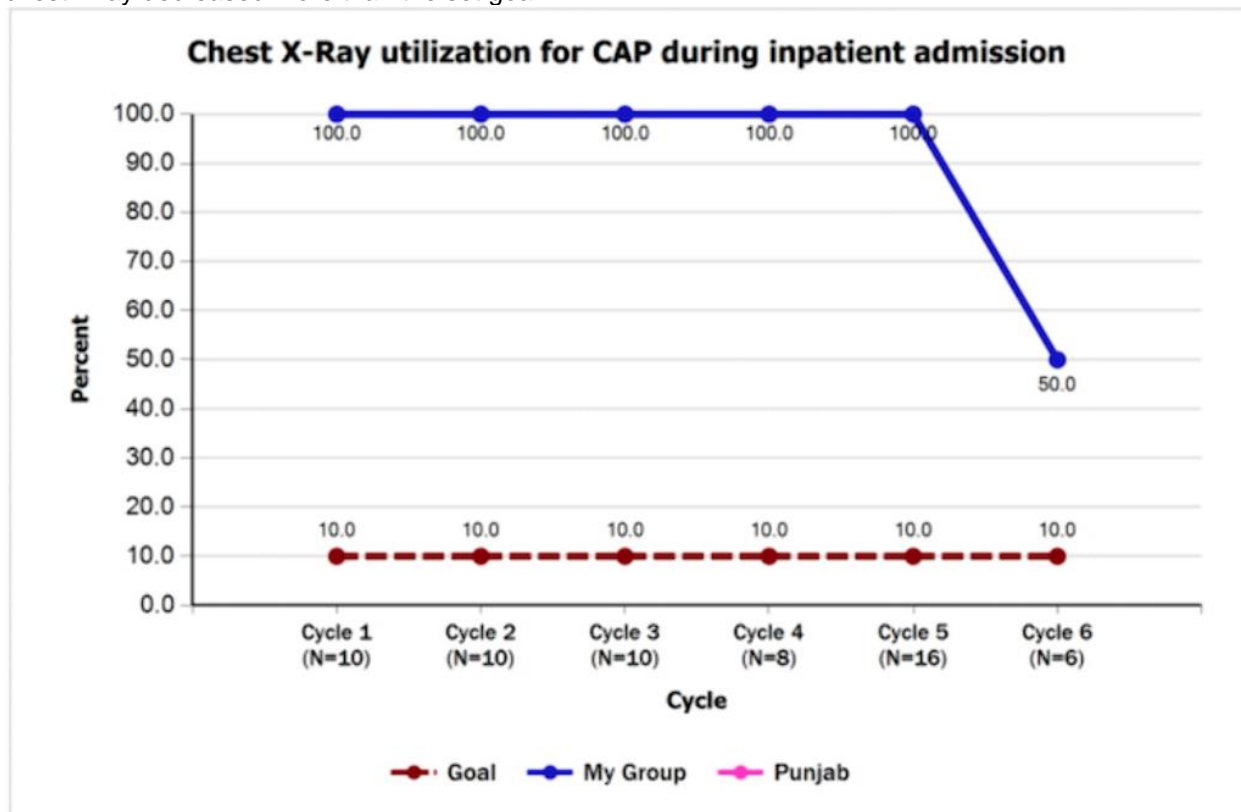

Conclusions/Learning Points: This real time experience of practicality of implementation of guidelines

with such approach can be an impetus for decreasing the use of chest x-ray for managing pediatric pneumonia by the clinicians.

EP307 / #1925

Topic: AS08. Respiratory infections (only non-SARS-CoV2 content) / AS08.b. Bacterial pneumonia

PNEUMONIA CAUSED BY STREPTOCOCCUS PNEUMONIA IN A YOUNG CHILD- CASE REPORT

E-Posters

E-POSTER VIEWING

Olga Smilevska Spasova¹, Katerina Boshkovska², Gorica Popova³, Mirjana Popovska¹

¹Institute of Respiratory Diseases in Children-Kozle, Pediatrics, Skopje, North Macedonia, ²Institute for respiratory diseases in children, Department For Tuberculosis, Skopje, North Macedonia, ³Institute for respiratory diseases in children, Department For Microbiology, Skopje, North Macedonia

Title of Case: PNEUMONIA CAUSED BY STREPTOCOCCUS PNEUMONIA IN A YOUNG CHILD- CASE REPORT

Background: Streptococcus pneumonia or pneumococcus is a Gram-positive, spherical bacteria, usually found in pairs (dipococci) is a member of the genus Streptococcus. Streptococcus pneumonia resides asymptotically in healthy carriers typically colonizing the respiratory tract, sinuses and nasal cavity. In individuals with weaker immune systems like young children pneumococcal bacterium is the most common cause of community acquired pneumonia in the world. Pneumococcal vaccines protect children from developing complications from the different strains of this bacterium.

Case Presentation Summary: The purpose is to present a case of pneumonia in a young child caused by a lower respiratory tract infection with streptococcus pneumonia that was successfully treated. Child presents 2 days with high fever, cough, lower appetite as well as malaise. At the primary care pediatrician treatment with oral penicillin V was started but it wasn't administered properly. At admittance the child is pale, with high fever, anxious with rapid respirations, cough and tachycardia. On auscultation: vesicular breathing sounds with high pitched wheezing and on the right coarse crackles. Blood analysis: RBC: 4, 43 x10¹², WBC: 20,4x10⁹: Gran: 71, 7%, SE: 55/110, CRP: 51, 3 mg/l, O₂sat-95% on blood gas analysis. X-ray chest with right pericardial consolidation. Microbiological analysis of sputum sample is positive for streptococcus pneumonia. Treatment was started with oral antipyretic the first day and intra venous antibiotic cefotaxim for 6 days as well as oral albuterol for 6 days. The Child is discharged from hospital on 7th day with resolution of clinical findings.

Learning Points/Discussion: Pneumococcal vaccine administration by the regular vaccination calendar, early diagnosis and appropriate treatment can significantly reduce morbidity and complications from this bacterial infection in young children.

Topic: AS08. Respiratory infections (only non-SARS-CoV2 content) / AS08.b. Bacterial pneumonia

AEROBIC FILAMENTOUS ACTINOBACTERIA FROM BRONCHIAL WASH OF AN IMMUNOCOMPROMISED CHILD: INFECTION OR COLONIZATION?

E-Posters

E-POSTER VIEWING

Angeliki Stathi¹, Fanouris Kontos², Malamati Mika¹, Evdoxia Mpourazani³, Helen-Dikaia Ioannidou⁴, Kirkira Banou¹, Kalliopi Spyridopoulou¹, Anna Simou⁵, Athanasia Stelianidi⁴, Ioanna Marsellou⁵, Giorgos Paradeisis¹, Evgenios Goussetis⁴, Aristeia Velegraki^{5,6}, Levantia Zachariadou¹ ¹"Aghia Sophia" Children's Hospital, Microbiology, Athens, Greece, ²"ATTIKON" General University Hospital, National and Kapodistrian University of Athens, Microbiology, Athens, Greece, ³ Athens, Greece, ⁴"Aghia Sophia" Children's Hospital, Stem Cell Transplant Unit, Athens, Greece, ⁵BIOMEDICINE S.A., Mycology Laboratory, Athens, Greece, ⁶Medical School, National and Kapodistrian University of Athens, Mycology Research Laboratory & Uoa/hcpf Culture Collection, Athens, Greece

Title of Case: AEROBIC FILAMENTOUS ACTINOBACTERIA FROM BRONCHIAL WASH OF AN IMMUNOCOMPROMISED CHILD: INFECTION OR COLONIZATION?

Background: Aerobic Actinobacteria are widespread soil bacteria, usually affecting the skin and subcutaneous tissues. Documented invasive infections, especially pulmonary, are rare, mostly in immunocompromised individuals. Microbiological analysis and clinical evaluation of more than one filamentous species, isolated from the bronchial wash of a paediatric oncology patient, are presented.

Case Presentation Summary: A 22-month-old girl with Congenital early-pre-B Acute Lymphoblastic Leukemia-(pre-B ALL), having undergone two bone marrow transplants, was admitted with CMV-pneumonitis. After 2-months of hospitalization, she was transferred to PICU, due to pneumothorax and pericardial fluid collection. Being in a serious, but stable, condition for 2-months, clinical symptoms worsened significantly and infection markers increased. Chest X-rays revealed significant bilateral infiltration of the lungs. Bronchial cultures, previously negative, revealed six phenotypic-different Gram-positive, acid-fast-negative filamentous bacteria on blood and chocolate agar (ThermoScientific™OXOID™), after 2-days of incubation. Blood cultures-(Hickman-peripheral) (BD PedsPlus™-Mycology BACTEC™-Becton Dickinson) were negative. Low MALDI-TOF/MS (Biotyper3.1-BRUKER®) identification scores (1.53-1.98), prompted 16SrRNA-gene-sequencing(1500 bp). Six Actinobacteria species: *Allokutzneria albata*, *Streptomyces albiacialis*, *Streptomyces alboniger*, *Streptomyces buochereae*, *Streptomyces lusitanus* and *Streptomyces thinghirensis* were identified (ID:100%). All strains were susceptible to amikacin, linezolid and tobramycin with a variety of sensitivity to other antibiotics by broth-microdilution (RAPMYCOI-TREK-Diagnostic systems) according to CLSI-M42/M62 documents (Table1). The child died 2-days later, under Transplant Associated Microangiopathy (TAM) and pulmonary haemorrhage, with identification and susceptibility tests being in progress.

Table 1 Antibiotic susceptibility of Actinobacteria species

| Antibiotic | <i>A. albata</i> | | <i>S. albiacialis</i> | | <i>S. alboniger</i> | | <i>S. buecherae</i> | | <i>S. lusitanus</i> | | <i>S. thinghirensis</i> | |
|-------------------------------|------------------|---|-----------------------|---|---------------------|---|---------------------|---|---------------------|---|-------------------------|---|
| | MIC (µg/mL) | | MIC (µg/mL) | | MIC (µg/mL) | | MIC (µg/mL) | | MIC (µg/mL) | | MIC (µg/mL) | |
| amikacin | <1 | S | <1 | S | <1 | S | <1 | S | <1 | S | <1 | S |
| amoxicillin/clavulanic acid | >64/32 | R | >64/32 | R | 16/8 | I | >64/32 | R | 8/4 | S | >64/32 | R |
| ceftriaxone | <4 | S | >64 | R | >64 | R | >64 | R | >64 | R | >64 | R |
| ciprofloxacin | 4 | R | 4 | R | >4 | R | >4 | R | 2 | I | 4 | R |
| clarithromycin | >16 | R | >16 | R | >16 | R | 8 | R | 2 | S | 1 | S |
| imipenem | >64 | R | >64 | R | 16 | R | <2 | S | 32 | R | 64 | R |
| linezolid | 2 | S | 4 | S | <1 | S | 2 | S | 4 | S | 4 | S |
| minocycline | 8 | R | >8 | R | 8 | R | 2 | I | <1 | S | >8 | R |
| moxifloxacin | 0.5 | S | 0.5 | S | 4 | R | 2 | I | 0.5 | S | 2 | I |
| trimethoprim/sulfamethoxazole | 1/19 | S | 1/19 | S | 0.5/9.5 | S | 1/19 | S | 8/152 | R | 0.5/9.5 | S |
| tobramycin | 8 | S | <1 | S | <1 | S | <1 | S | <1 | S | 1 | S |
| cefepime | 32 | R | >32 | R | - | - | - | - | - | - | - | - |
| doxycycline | 8 | R | >16 | R | - | - | - | - | - | - | - | - |

S=Susceptibility, R=Resistance, I=Intermediate Susceptibility

Learning Points/Discussion: TAM is a severe condition, potentially fatal. The contribution of Actinobacteria infection in the case's outcome as an aggravating or triggering factor was not excluded. Lower respiratory Actinobacteria isolation from immunosuppressed patients must not be underestimated. Molecular identification and susceptibility determination of filamentous Actinobacteria by broth dilution method is the unidirectional process.

EP309 / #1282

Topic: AS08. Respiratory infections (only non-SARS-CoV2 content) / AS08.c. ENT infections

RECURRENT ACUTE MASTOIDITIS AMONG HOSPITALIZED CHILDREN: INCIDENCE AND CHARACTERISTICS

E-Posters

E-POSTER VIEWING

Liat Ashkenazi-Hoffnung^{1,2}, Miri Gelbart³, Oded Scheurman⁴, Efraim Bilavsky⁵

¹Schneider Children's Medical Center, Departement Of Day Hospitalization, Petah Tikva, Israel, ²Tel Aviv University, Sackler Faculty Of Medicine, Tel Aviv, Israel, ³Schneider Children's Medical Center, Pediatrics A, Petah Tikva, Israel, ⁴Schneider Children's Medical Center, Pediatrics B, Petah Tikva, Israel, ⁵Schneider Children's Medical Center, Pediatrics C, Petah Tikva, Israel

Backgrounds: Data on pediatric recurrent acute mastoiditis are lacking, despite its morbidity and potential clinical significance. We described the incidence, characteristics, and associated factors of recurrent mastoiditis in hospitalized children.

Methods: Records of children under 18 years, hospitalized with acute mastoiditis in a tertiary pediatric medical center, between June 2011 and December 2017, were analyzed. Recurrent mastoiditis was defined as recurring mastoiditis at least four-weeks after a completely resolved event.

Results: Of 347 children with acute mastoiditis, 22 (6%) had recurrent mastoiditis; the median interval between episodes was three months (range: 1-36). The mean age was 2.3±2.25 years. Age, sex and history of ear infections did not differ between children with and without recurrent mastoiditis; however, a history of atopic dermatitis was more prevalent among children with recurrent mastoiditis (27.3% vs. 1.2%, p<0.001). The second episode of acute mastoiditis was characterized by a shorter interval between symptom onset and hospitalization (2.8 vs. 5 days, p <0.001) and a milder clinical course. This was evident by a lower rate of fever (24% vs. 65%, p=0.012), a lower platelet count (473 K/micl vs. 550 K/micl, p=0.004); and a shorter duration of intravenous antibiotic therapy and length of hospitalization, (6.6 vs. 10 days, p=0.012 and 6.6 vs. 9.7 days, p=0.022, respectively).

Conclusions/Learning Points: Children with atopic dermatitis may be at increased risk for recurrent acute mastoiditis. Recurrent episodes of mastoiditis were clinically milder, with shorter hospitalization compared to first episodes, possibly because of earlier hospitalization.

EP310 / #809

Topic: AS08. Respiratory infections (only non-SARS-CoV2 content) / AS08.c. ENT infections

ASSESSMENT OF LYMPHADENOPATHIES MANAGEMENT OF IN AN OUTPATIENT PEDIATRIC INFECTIOUS DISEASES CLINIC

E-Posters

E-POSTER VIEWING

Ana Isabel Dacosta Urbieto^{1,2}, María Montserrat López Franco^{1,2}, Fernando Caamaño Viña^{1,2}, Irene Rivero Calle^{1,2}

¹Complejo Hospitalario Universitario de Santiago de Compostela, Translational Pediatrics And Infectious Diseases Section, Santiago de Compostela, Spain, ²GENVIP, Genetics, Vaccines, Infectious Diseases And Pediatrics Research Group., Santiago de Compostela, Spain

Title of Case: Assessment of Lymphadenopathies Management of in an Outpatient Pediatric Infectious Diseases Clinic

Background: Lymphadenopathy is a common problem in childhood and requires a careful physical examination and follow-up. Although lymphadenopathy is mostly related with infections, care should be taken in terms of malignancy and it should be ruled out in specific cases. We review the management of all patients with a new diagnosis of lymphadenopathy that were referred to our clinic during 2021.

Case Presentation Summary: 36 patients were referred: 16,7% (N=6) acute cases, 44,4% (N=16) subacute cases, and 38,9% (N=14) chronic. Mean time between onset of symptoms and first evaluation was 1,36 months IC95% (1,02-1,71). 69,4% (N=25) had an ultrasound performed and 63,9% (N=23) received antibiotics. 33,3% (N=12) had warning signs and a biopsy was performed in 6 of them (1 patient being diagnosed with Hodgkin's Lymphoma. In the patients with no warning signs (66.6%, n=24) a biopsy was performed in 3 patients due to the persistence of symptoms (1 of them diagnosed with Diffuse Large B-cell Lymphoma). For both groups, mean time between first visit and the biopsy was 1,02 months IC95% (0,52-1,53). Final diagnosis was: 33,3% (N=12) a confirmed infectious etiology with a microbiological isolate, 33,3% (N=12) infectious etiology with no microbiological confirmation, 5,6% (N=2) a Lymphoma and 27,8% (N=10) other etiology.

Learning Points/Discussion: Infectious diseases are the most common underlying cause of lymphadenopathies. Worrisome features should lead to additional evaluation and aid the clinician in determining whether a biopsy should be performed. Time-lapse between first evaluation and a biopsy seem to be adequate in our series. However, accuracy of microbiological diagnosis should be improved as the microbiological etiology could not be confirmed in half of the infectious cases.

EP311 / #1267

Topic: AS08. Respiratory infections (only non-SARS-CoV2 content) / AS08.c. ENT infections

RECURRENT BILATERAL CERVICAL LYMPHADENITIS

E-Posters

E-POSTER VIEWING

Inês Oliveira¹, Vera Miranda², Inês Costa¹, Francisca Guimarães Strecht³, Teresa Oliveira³, Lúcia Gomes³

¹Centro Materno-Infantil do Norte, Centro Hospitalar Universitário do Porto, Paediatrics, Porto, Portugal, ²Centro Hospitalar Entre Douro e Vouga, Otorhinolaryngology, Santa Maria da Feira, Portugal, ³Centro Hospitalar Entre Douro e Vouga, Paediatrics, Santa Maria da Feira, Portugal

Title of Case: Recurrent bilateral cervical lymphadenitis

Background: Cervical lymphadenitis is common in childhood and usually is caused by an infectious process. Acute bilateral cervical lymphadenitis is most often caused by a benign, self-limited viral upper respiratory infection. Group A streptococcal (GAS) pharyngitis is a common cause, but there are other viral and bacterial causes. Subacute/chronic bilateral lymphadenitis is most commonly seen in EBV or CMV infections, but sometimes it is caused by tuberculosis, HIV, toxoplasmosis and syphilis.

Case Presentation Summary: The authors describe the clinical case of a 4 year-old boy with multiple episodes of fever, vomiting and bilateral cervical adenopathy conglomerates since the age of two , with otitis media with effusion and tonsil hypertrophy. He was previously hospitalized four times for intravenous antibiotics, but several other episodes required oral antibiotics. The serial ultrasound study aimed at bilateral cervical lymphadenitis suggested an infectious process. Infection caused by EBV, CMV, toxoplasmosis and Bartonella Henselae were excluded. Neutrophilic leucocytosis and increased of serum CRP were detected. Group A streptococcal (GAS) pharyngitis was positive only in one episode. Immunological studies were normal.

According to the recurrent infections in the same location, the child was proposed for elective adenotonsillectomy with removal of fibrous tonsils and bilateral myringotomy with placement of middle-ear ventilation tubes, procedure without complications.

After 6 months of surgery, he is well, with no new similar episodes.

Learning Points/Discussion: This case of a child with recurrent bilateral cervical lymphadenitis, shows a situation that, despite being common in pediatrics and with possibility of conservative therapy in majority of the cases, may require surgical treatment for its complete resolution.

EP312 / #914

Topic: AS08. Respiratory infections (only non-SARS-CoV2 content) / AS08.c. ENT infections

SHEWANELLA ALGAE ISOLATION FROM A 14-YEAR-OLD PATIENT WITH CHRONIC OTITIS MEDIA AND MASTOIDITIS ASSOCIATED WITH CHOLESTEATOMA

E-Posters

E-POSTER VIEWING

Giorgos Paradeisis¹, Kalliopi Spyridopoulou¹, Evangelia Petridou¹, Eirini Vazaiou², Sophia Zisi¹, Anna-Maria Triantou³, Sofia Stamataki², Levantia Zachariadou¹

¹"Aghia Sophia" Children's Hospital, Microbiology, Athens, Greece, ²Aghia Sophia Children's Hospital, Otolaryngology, Athens, Greece, ³Aghia Sophia Children's Hospital, Athens, Greece, Otolaryngology, Athens, Greece

Title of Case: SHEWANELLA ALGAE ISOLATION FROM A 14-YEAR-OLD PATIENT WITH CHRONIC OTITIS MEDIA AND MASTOIDITIS ASSOCIATED WITH CHOLESTEATOMA

Background: Shewanella genus includes mostly saprophytic, Gram-negative widespread environmental rods, first isolated in 1931. Shewanella algae is an emerging human pathogen, being involved mostly in bacteremia, ear, skin, soft tissue, abdominal and biliary tract infections, correlated with exposure to warm seawater. Chronic otitis media with mastoiditis from *S. algae*, *Pseudomonas aeruginosa* and *Prevotella prevotii* is presented.

Case Presentation Summary: A 14-year-old boy with chronic otitis media and mastoiditis was transferred from a provincial hospital to the Otolaryngologist Department with persistent temporal headache, earache, ear drainage and fever 38.1°C, despite treatment with ceftriaxone and clindamycin. Laboratory findings: WBC 13,780 cells/μL (62.4% neutrophils), CRP 74 mg/L, ESR 77 mm/h. Ear-microscopy: retraction pocket in pars flaccida of the tympanic membrane with polypoid formation, small quantity of pus (culture 1). Computed Tomography: opacification of the middle ear cavity and the air cells of mastoid bone with coalescence. Myringotomy was performed, giving no discharge. Incision and drainage of the retroauricular area derived quantity of pus (culture 2). Therapy with IV piperacillin/tazobactam and clindamycin was started and, because of no significant improvement, mastoidectomy was performed, which showed the middle ear and the mastoid occupied with granulation tissue and cholesteatoma. Cultures revealed *S. algae*, *P. aeruginosa*, *P. prevotii* and *S. algae* respectively. *S. algae* was identified by VITEK-2-automated system. Kirby-Bauer testing: susceptibility to aminoglycosides, piperacillin/tazobactam, co-trimoxazole, meropenem, ceftazidime, ciprofloxacin, colistin and resistance to ticarcillin/clavulanic, imipenem, comparable with literature data. The patient was discharged within 14 days.

Learning Points/Discussion: *S. algae* isolation, as part of a polymicrobial flora or from pure culture, in case of invasive infections highlights it as an emerging pathogen. *S. algae* is susceptible to aminoglycosides, carbapenemes, erythromycin, quinolones and 3rd generation cephalosporins, but resistant to penicillin.

EP313 / #823

Topic: AS08. Respiratory infections (only non-SARS-CoV2 content) / AS08.c. ENT infections

NASAL MYIASIS CAUSED BY OESTRUS OVIS

E-Posters

E-POSTER VIEWING

Mário Ribeiro¹, Ana Carvalho¹, Silvana Belo², Helena Silva¹

¹Hospital de Braga, Serviço De Pediatria, Braga, Portugal, ²Instituto de Medicina Tropical da Universidade Nova de Lisboa, Helminologia Médica, Lisboa, Portugal

Title of Case: NASAL MYIASIS CAUSED BY OESTRUS OVIS

Background: Myiasis is the infection of a fly larva in human tissue and usually occurs in tropical areas. The most common site of infection is the conjunctival sac, but it can also affect the mouth, nose and ears. The majority of reported cases with nasal myiasis caused by *Oestrus Ovis* are unaware of any contact with sheep.

Case Presentation Summary: A 17-year-old female, living in an urban area, was admitted to the hospital with complaints of cough and nasal obstruction associated with the presence of larvae in her nasal mucus. A week earlier, she had been seen by an ophthalmologist who removed larvae from her right ocular globe. She had not travelled to tropical countries and she had no contact with farm animals or fever. The patient began nasal saline irrigations and completed five days of therapy with Albendazol 400 mg once a day. Blood tests did not show leukocytosis or eosinophilia, erythrocyte sedimentation rate was 41 mm/h and C-reactive protein was 13 mg/L. Larvae samples obtained from nasal mucus were analysed by the Portuguese Institute of Tropical Medicine and stage one *Oestrus Ovis* (L1) larvae were identified. Nasofibrosocopy and flexible bronchoscopy, as well as the bronchoalveolar lavage, did not show any larvae. Faecal parasite identification was also negative. Five days after the first larvae were seen in mucus, the patient's symptoms spontaneously resolved and no more larvae were



detected.

Learning Points/Discussion: This is a rare case of parasite infection which can have a psychological impact and highlights the importance of identifying the larva involved. The fly's life cycle does not become complete human and through cough, sneezes and nasal irrigation a complete elimination of the larvae is possible.

EP314 / #1012

Topic: AS08. Respiratory infections (only non-SARS-CoV2 content) / AS08.c. ENT infections

ACTINOMYCES AND SHEWANELLA ALGAE COMPLICATED MASTOIDITIS – CASE REPORT

E-Posters

E-POSTER VIEWING

Madalena Von Hafe, Nuno Santos, Margarida Dias, Mafalda Sousa, Gil Coutinho, Ana Reis E Melo
Centro Hospitalar de São João, Pediatrics, porto, Portugal

Title of Case: ACTINOMYCES AND SHEWANELLA ALGAE COMPLICATED MASTOIDITIS – CASE REPORT

Background: Cerebral venous sinus thrombosis in children is a rare but potentially fatal complication of acute mastoiditis, one of the most common pediatric infectious diseases. Acute mastoiditis is usually caused by *Streptococcus pneumoniae* or *Streptococcus pyogenes*. We present the first known case of pediatric acute mastoiditis with venous sinus thrombosis caused by *Shewanella algae* (*S. algae*) and *Actinomyces europaeus* (*A. europaeus*).

Case Presentation Summary: A 17-year-old adolescent with a recent history of acute otitis media refractory to amoxicillin/clavulanic acid (10 days) and ceftriaxone (3 days), returns to the Emergency Department due to otalgia, otorrhea, and retroauricular pain, without fever. Physical examination revealed acute otitis media possibly complicated by mastoiditis, without neurological signs. Contrast-enhanced cranioencephalic CT confirmed mastoiditis with ossicular erosion, extension to the extradural space, and venous sinus thrombosis. Empirical antibiotic treatment (vancomycin, ceftriaxone, and metronidazole) and surgical (mastoidectomy and myringotomy) were performed. After isolation of *S. algae* and *A. europaeus* in the intraoperative pus of the mastoid, antibiotic therapy was adjusted for ceftazidime and penicillin G, which was carried out for 4 weeks. The adolescent presented good clinical evolution, being discharged with oral amoxicillin, for 6 months. Immunodeficiency was excluded.

Learning Points/Discussion: Patients with acute mastoiditis are at high risk of central nervous system involvement. Although thrombosis typically courses with high fever, otalgia, otorrhea, and changes on neurological examination, prior antibiotic therapy can result in a more frugal presentation. There are a few reported cases of ear infections by *S. algae*, but this is the first case of pediatric acute mastoiditis by this agent. *S. algae* is frequently associated with other pathogenic microbes. Infections by *A. europaeus* are difficult to diagnose due to their variable presentation and gradual growth in culture. The approach to this complication must be multidisciplinary.

EP315 / #1777

Topic: AS09. *Mycobacteria and retroviruses / AS09.a. Tuberculosis and other mycobacterial infections*

PEDIATRIC COVID-TB: NEW CO-INFECTIONS NEED NEW STRATEGIES

E-Posters

E-POSTER VIEWING

Fabrizio Leone¹, Martina Di Giuseppe², Maia De Luca², Laura Cursi², Sara Chiurchiù², Lorenza Romani², Stefania Bernardi², Laura Lancella²

¹Policlinico Umberto I, Sapienza University, Department Of Pediatrics, Rome, Italy, ²Bambino Gesù Children's Hospital, IRCCS, Immunology An Infectious Diseases Unit, Rome, Italy

Title of Case: PEDIATRIC COVID-TB: new co-infections need new strategies

Background: SARS-CoV-2 infection (COVID-19) and tuberculosis (TB) are currently two main causes of death among infectious diseases. Both active TB and a previous history of TB seem to be related to an increased risk for the development of COVID-19. This coinfection, known as COVID-TB, was never described in children. We report 3 cases of pediatric COVID-TB with different clinical involvement.

Case Presentation Summary: We describe three COVID-TB-infected girls. The first one was 5-year-old and she was hospitalized for recurrent TB lymphadenopathy, she tested positive for SARS-CoV2 at admission and showed no COVID-19 related symptoms. The second patient, 10-year-old, was hospitalized for supraclavicular swelling. The investigations showed extended pulmonary and bone tuberculosis. She was treated with antitubercular and supportive therapy. The second one, aged 13, was also a patient with a known pulmonary and splenic tuberculosis. She was admitted to hospital due to deteriorating respiratory dynamics. She was already undergoing treatment for tuberculosis, but in the absence of improvement, she also required treatment for COVID-19. Slowly the general conditions improved until discharge.

Learning Points/Discussion: Understanding the immunological mechanisms involved in the susceptibility and prognosis will be fundamental in the prevention and treatment of COVID-TB, especially in children. Two of the cases described did not have a worse course of the disease during COVID-19, but the third patient had a pulmonary exacerbation. The main cytokines that contribute to the containment of the bacillus, TNF and IFN- γ , also play a key role in the response against SARS-CoV-2. The precise role of IFN signaling in bacterial infection is unclear, but its ambivalence seems evident. It appears clear the urgency for further studies focused on COVID-TB, to contain this association with new strategies.

EP316 / #1514

Topic: AS09. *Mycobacteria and retroviruses / AS09.a. Tuberculosis and other mycobacterial infections*

INGUINAL TUBERCULOUS ADENOPATHY WITH A PECULIAR ORIGIN

E-Posters

E-POSTER VIEWING

Dara Boza Medina, Manuel Rodríguez Lanza, Esther Orts Martínez
Hospital Doctor José Molina Orosa, Pediatrics, Arrecife, Spain

Title of Case: INGUINAL TUBERCULOUS ADENOPATHY WITH A PECULIAR ORIGIN

Background: Lymphadenitis is the most frequent extrapulmonary manifestation caused by *Mycobacterium tuberculosis*. The unusual inguinal location often has an unknown origin; however, it has been related to the contact of wounds with contaminated objects.

Case Presentation Summary: A 4-year-old boy presented with fever, weight loss and a left inguinal adenopathy (3.5 cm). Lymphatic nodes were warm and showed erythematous violaceous colour and desquamation on the surface. The patient had suffered an injury in the left foot three months before, with a very slow recovery which required special treatments including cryotherapy. Laboratory results showed hemoglobin 13.5 g/dL, leukocytes 8100/uL (lymphocytes 73%, neutrophils 14.4%), CRP 0.1 mg/dL, lactate dehydrogenase 282 U/L, ferritine 33 mg/dL. Chest X-Ray was normal. Inguinal echography revealed multiple adenopathy and a hypoechoic region consistent with suppurative adenitis. Abdominal ultrasound was normal. Intravenous clavulanic-amoxicillin was started with no changes. The tuberculin skin test measured 14 mm diameter of induration. In addition, QuantiFERON test was positive. Serological studies which included HIV, CMV, EBV, *Bartonella henselae* and *Toxoplasma gondii* were negative, and the immunity study was normal. Blood culture was also negative. Fine needle aspiration of the lymph node removed septic secretion, and biopsy showed granulomatous suppurative lymphadenitis. Bacilloscopic revealed an elevated quantity of *Mycobacterium tuberculosis*. Therapy consisted in isoniazid, rifampicin and pyrazinamide for 9 months, resulting in a slowly improvement until resolution.

Learning Points/Discussion: We assume that the contact with a pool surface was the origin of the *Mycobacterium tuberculosis* infection. From this experience we learned that an abnormal evolution of a skin lesion should be further investigated to initiate an earlier and accurate therapy.

EP317 / #1484

Topic: *AS09. Mycobacteria and retroviruses / AS09.a. Tuberculosis and other mycobacterial infections*

THREE CASES OF PEDIATRIC TB IN THE LAST 20 MONTHS IN A PEDIATRIC WARD IN BOLOGNA, NORTHERN ITALY, IS THIS A COINCIDENCE OR THE TIP OF THE ICEBERG?

E-Posters

E-POSTER VIEWING

Rosa Francavilla^{1,2}, Valentina Alberghini², Felicia Stella², Claudia Balsamo², Orsola Imbornone², Chiara Franzonello², Francesca Di Florio², Chiara De Mutiis², Paola Salvago², Cristiana Retetangos², Francesca Lombardi², Anna Martoni², Flavio Labriola², Chiara Zarbo², Chiara Ghizzi²

¹UOC Pediatria, AUSL Bologna, Ospedale Maggiore, Dipartimento Materno-infantile, Bologna, Italy, ²UOC Pediatria, Ospedale Maggiore, Azienda Sanitaria Locale Bologna, Dipartimento Materno Infantile, Bologna, Italy

Title of Case: Three cases of pediatric TB in the last 20 months in a pediatric ward in Bologna, Northern Italy, is this a coincidence or the tip of the iceberg?

Background: Before the COVID-19 pandemic, tuberculosis was the deadliest infectious disease with about 10 million cases and 1.5 millions deaths worldwide each year. The WHO predicts that even a 50% reduced TB notification rate over a 3-month period may translate into 400000 additional cases alone.

Case Presentation Summary: We considered the medical records of patients hospitalized with a diagnosis of tuberculosis in our pediatric ward in the period 1 March 2020 to 31 December 2021. Over a period of 22 months, in a general pediatrics ward, in Bologna, Northern Italy, we hospitalized 3 patients with tuberculous disease. Case 1. A 16-year-old boy from Pakistan was admitted in March 2020 with diagnosis of spinal tuberculosis and epidural abscess T9-T10 and spinal cord compression and iliopsoas abscess. Case 2. A 13-year-old girl of origin Pakistani, born in Italy, was hospitalized at the end of February 2021 with a diagnosis of pulmonary tuberculosis and severe malnutrition. Case 3. A 14-year-old boy who emigrated from Pakistan who was hospitalized in March 2021 diagnosed with T9-T10 vertebral tuberculosis with epidural abscess and spinal cord compression.

Learning Points/Discussion: In the coming months it will be necessary to maintain a high level of attention with respect to tuberculous disease, even in low-incidence countries, to avoid diagnostic delays with consequent more serious clinical cases and sequelae.

EP318 / #545

Topic: AS09. *Mycobacteria and retroviruses / AS09.a. Tuberculosis and other mycobacterial infections*

THE MONOCYTE TO LYMPHOCYTE AND NEUTROPHIL TO LYMPHOCYTE RATIO AS DIAGNOSTIC, PROGNOSTIC AND TREATMENT MARKER FOR TUBERCULOSIS; A SYSTEMATIC REVIEW

E-Posters

E-POSTER VIEWING

Nora Fritschj^{1,2}, Nina Vaezipour², Michael Buettcher³, Damien Portevin⁴, Vivek Naranbhai^{5,6,7}, Nicole Ritz^{8,9,10}

¹University Children Hospital Basel, Emergency, Basel, Switzerland, ²University children hospital Basel, Mycobacterial Research, Basel, Switzerland, ³Pediatric Infectious Diseases Unit, Lucerne Cantonal Hospital, Lucerne, Switzerland, ⁴University of Basel, Immunology, Basel, Switzerland, ⁵Massachusetts General Hospital Cancer Center, Oncology, Boston, United States of America, ⁶Dana-Farber Cancer Institute, General, Boston, United States of America, ⁷Center for the AIDS Programme of Research in South Africa, General, Durban, South Africa, ⁸Mycobacterial and Migrant Health Research Group, University of Basel, Department Of Clinical Research, Basel, Switzerland, ⁹Children's Hospital Lucerne Cantonal Hospital, Department Of Paediatrics And Paediatric Infectious Diseases, Lucerne, Switzerland, ¹⁰The Royal Children's Hospital Melbourne, The University of Melbourne, Department Of Pediatrics, Melbourne, Australia

Backgrounds: The monocyte to lymphocyte (MLR) and neutrophil to lymphocyte (NLR) ratio were described to be associated several inflammatory conditions and infections. The aim of this study was to systematically review the literature for MLR and NLR as prognostic, diagnostic and treatment marker for tuberculosis (TB).

Methods: The literature search was done on OVID for Medline and Embase, and in the Cochrane library on 22 January 2021. The following search terms and strategy were used: tuberculosis AND (monocyte OR neutrophils), AND lymphocytes, AND (diagnostic OR prognostic OR treatment).

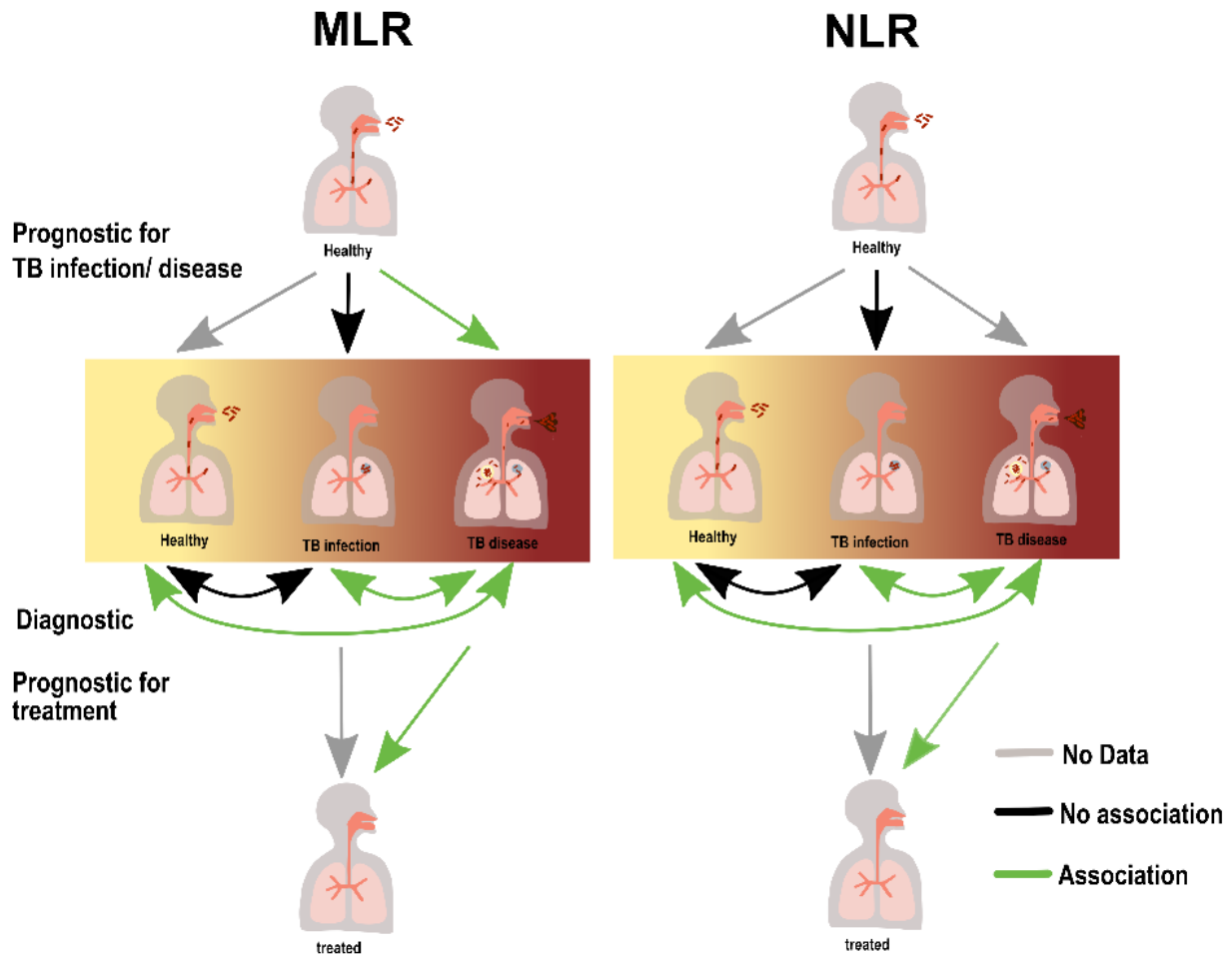

Results: A total of 1617 studies were identified, of which 31 studies were included in the final analysis. Eight studies included children and four studies included patients living with HIV. Most compared individuals with TB disease (TBD) to those with TB infection (LTBI) or healthy controls, while comparison of MLR and NLR in TBD to sick controls was reported in only 3 and 6 studies, respectively. Studies enrolled a median of 153 (IQR 118 to 280) individuals. MLR and NLR were assessed in 17 and 19 studies, respectively. A total 30 data sets for MLR and 30 for NLR were extracted. An increased MLR and NLR were associated TBD when compared to healthy controls and individuals with LTBI. MLR was shown to be a prognostic marker for progression to TBD. MLR decreased with TB treatment. The cut-offs determined in the studies were highly variable for MLR and NLR, and prevented a meta-analysis of sensitivity and specificity.

Conclusions/Learning Points: A higher MLR and NLR is associated with TBD and therefore may be easily used as additional diagnostic markers at low-cost. Further studies investigating these markers across symptomatic presumptive cases with and without TBD are required.

EP319 / #1248

Topic: AS09. *Mycobacteria and retroviruses / AS09.a. Tuberculosis and other mycobacterial infections*

SKIN INFECTIONS UNCOVER DIVISION OF LABOUR IN TISSUE MACROPHAGES

E-Posters

E-POSTER VIEWING

Florens Lohrmann, Philipp Henneke
University hospital Freiburg, Paediatrics, Freiburg, Germany

Backgrounds: Macrophages (MAC) densely populate barrier tissues like the skin. They originate from either primitive or definitive hematopoiesis, yet they are largely renewed by monocyte-derived macrophages. In the tissue, they display substantial diversification with adaptation to microanatomical structures. However, the underlying mechanisms and functional implications of this diversity, both in homeostasis and bacterial infection are poorly understood.

Methods: To gain new ground, we dissected *Irf8* deficiency, where severe monocytopenia is linked to mycobacterial tissue infections, by adapting single-cell transcriptomics, fate mapping, and imaging.

Results: In resting skin the majority of dermal MAC was of monocyte origin. Monocyte-derived MAC were distinct from long-term resident MAC with respect to gene expression and localization, although the proportion of MAC which was never exchanged was substantially larger than previously appreciated (40%). In homeostasis dermal *Irf8*-deficient MAC exhibited striking plasticity to discretely diversify covering the vast majority of the transcriptional repertoire and ensuring density, even though the largest cellular input was lost. Moreover, infection with the typical skin colonizer *S. aureus* was cleared without major impact of *Irf8*. In contrast, *Irf8* was essential for steering MAC density at the site of the mycobacterial infection, resulting from lacking recruitment of monocyte-derived macrophages. This situation uncovered a distribution of labor between long-term resident and recently immigrated MAC. Whereas recruited MAC took up bacteria and produce anti-mycobacterial iNos, resident MAC abstained from inflammation initiation and rather contributed to its resolution. On the single cell level, *Irf8* deficiency impacted on granuloma MAC transformation without restricting bacterial phagocytosis or expression of inflammatory genes.

Conclusions/Learning Points: Tissue MAC exhibit striking plasticity to adapt to discrete tissue niches without need for incoming monocytes. Yet monocyte derived MAC are critical to expand the MAC repertoire in specific infections.

EP320 / #1458

Topic: AS09. *Mycobacteria and retroviruses / AS09.a. Tuberculosis and other mycobacterial infections*

A RARE CASE OF PARADOXICAL LYMPH NODE REACTION IN A YOUNG GIRL WITH MULTIFOCAL TUBERCULOSIS

E-Posters

E-POSTER VIEWING

Khouloud Mnif, Ichrak Bougharriou, Salma Ben Hmida, Nabil Lachiheb, Tarak Ben Jemaa, Khaoula Rekik, Fatma Smaoui, Makram Koubaa, Chakib Marrakchi, Boussayma Hammami, Mounir Ben Jemaa Hedi Chaker Hospital, Infectious Diseases Department, SFAX, Tunisia

Title of Case: A rare case of paradoxical lymph node reaction in a young girl with multifocal tuberculosis

Background: Pediatric multifocal tuberculosis (MT) is rare. Paradoxical lymph node reaction (PR) is defined as a worsening of pre-existing adenopathies, or as the formation of new adenopathies during appropriate treatment. We report a rare case of MT in a young girl hospitalized in an infectious diseases department who developed later a PR.

Case Presentation Summary: A fifteen-year-old girl was hospitalized for fever, night sweats, weight loss, asthenia, cough, and cervical and axillary lymph node occurring for one month. Search a *Mycobacterium tuberculosis* in sputum was positive. Biopsy of axillary lymph node founded tubercular granulomas and caseous necrosis. A CT scan found miliary tuberculosis, mediastinal necrotic adenopathies, multiple nodules in the liver, multiple nodules in the spleen, two medio-renal nodules, micronodular infiltration of the large epiploon, and tuberculomas of the brain. Antituberculous treatment with HRZE was received for two months then relayed by HR. Four months later, apyrexia, recovery of appetite, and weight gain were noted. But, cervical lymph nodes persisted, cervical abscesses appeared, the retro-auricular lymph node was fistulized and a new lymph node in the left thigh appeared. PCR of cervical abscess puncture fluid was positive for rifampicin-sensitive *Mycobacterium tuberculosis*. A CT scan showed the increased size of cervicothoracic adenopathies. The immune checkpoint was normal. We decided to reintroduce ethambutol for 2 months and then relay it by HR. The outcome was favorable with clinical improvement with a follow-up of 15 months.

Learning Points/Discussion: The occurrence of PR is associated with extra-lymph node tuberculosis. The treatment of this PR is based on the strengthening of anti-tuberculosis treatment or surgical excision of adenopathies or steroids.

EP321 / #1413

Topic: AS09. *Mycobacteria and retroviruses / AS09.a. Tuberculosis and other mycobacterial infections*

COVID - 19 AND TUBERCULOSIS IN CHILDREN - AN EMERGING PUBLIC HEALTH PROBLEM

E-Posters

E-POSTER VIEWING

Zahabiya Nalwalla, Akanksha Jaiswal, Reepa Agrawal, Ira Shah
Bai Jerbai Wadia Hospital for Children, Department Of Pediatric Infectious Diseases, Mumbai, India

Title of Case: COVID - 19 AND TUBERCULOSIS IN CHILDREN - AN EMERGING PUBLIC HEALTH PROBLEM

Background: Years of global progress with Tuberculosis (TB) has been stalled with the COVID-19 pandemic due to disruption of essential services leading to a rise in TB-related deaths. We present a cohort of 5 children with multi-drug resistant pulmonary tuberculosis (MDR-PTB) who were diagnosed to have SARS-CoV-2.

Case Presentation Summary: 5 adolescents, aged between 11 to 17 years were diagnosed with MDR PTB. They were initiated on anti-tubercular therapy (ATT). Within 4-6 months of initiation of ATT they were diagnosed to have SARS-CoV-2. One of them had mild symptoms and received symptomatic treatment, while the others required admission to the intensive care unit, intravenous immunoglobulin and steroids. One of them required remdesivir. Three of them showed worsening chest imaging and one of them developed disseminated TB. Two of them had episodes of anxiety and panic attacks requiring psychiatric evaluation and counseling. All of them survived and are on regular follow up. In this cohort, all the children who had COVID were active cases of MDR pulmonary tuberculosis, indicating the common route of transmission (airborne) and pathogen characteristics. Both the virus and the bacteria tend to infiltrate the pulmonary microenvironment. Damage produced by TB may increase the susceptibility to COVID and a more severe form of the infection as evidenced by the cohort. In turn, COVID cytokine storm may cause immune exhaustion and activation of latent TB, or dissemination of the bacteria. Although all five children survived, TB and COVID co-infection led to significant morbidity, including deterioration of mental health.

Learning Points/Discussion: TB and COVID co-infection is a public health problem, with common risk factors, but varied immune-pathology and clinical features, requiring further studies.

EP323 / #1572

Topic: AS09. *Mycobacteria and retroviruses / AS09.a. Tuberculosis and other mycobacterial infections*

TUBERCULOSIS IN A PORTUGUESE ADOLESCENT: KEEP IN MIND

E-Posters

E-POSTER VIEWING

Inês Pedrosa¹, Ana Reis E Melo², Margarida Tavares³

¹Centro Hospitalar de Leiria, Department Of Pediatrics, Leiria, Portugal, ²Centro Hospitalar Universitário de São João, Pediatrics Infectious Diseases And Immunodeficiencies, Porto, Portugal, ³Centro Hospitalar Universitário de São João, Paediatrics Infectious Diseases And Immunodeficiencies, Porto, Portugal

Title of Case: TUBERCULOSIS IN A PORTUGUESE ADOLESCENT: KEEP IN MIND

Background: Tuberculosis (TB) remains a major world health problem with significant morbidity. The recent pandemic-related challenges of diagnosing and treating the disease are causing many cases of TB to go undetected and undiagnosed worldwide.

Case Presentation Summary: A previously healthy 16-year-old girl presented with a 2-month history of productive non-hemoptoic cough, fatigue, night sweats and 10% weight loss. New onset thoracic pain, fever and persistent cough motivated admission to the ER. Pulmonary auscultation demonstrated diminished breath sounds, disperse rales and audible tubular breath sound over the left upper lung. She had anaemia (Hb 8g/dL), leukocytosis (20080/uL with neutrophilia), increased ADA levels and CRP (137,9mg/L). Chest CT (fig. 1) revealed 3 upper lobe cavitations (left lobe 59mm; right lobe 14 and 21mm) with bronchogram and bronchiectasis, parenchymal involvement at upper lobes and left inferior lobe and paratracheal lymphadenopathies. Direct sputum analysis contained numerous acid-fast bacilli, PCR for *M. tuberculosis* was positive and *M. tuberculosis* was subsequently cultured. The patient was started on ampicillin and anti-TB therapy (isoniazid (INH), rifampicin (RIF), pyrazidamine, ethambutol and pyridoxine). No mutations corresponding to RIF or INH resistance were identified. HIV infection was excluded. A previous contact with TB was identified: the adolescent's mother was diagnosed with active pulmonary TB ten years earlier, and the adolescent completed 6-month chemoprophylaxis with INH. The patient slowly recovered in the first week, with persistent fever, leading to a switch to amoxicillin+clavulanic acid treatment with progressive clinical and radiological improvement. She is currently asymptomatic under anti-TB therapy.

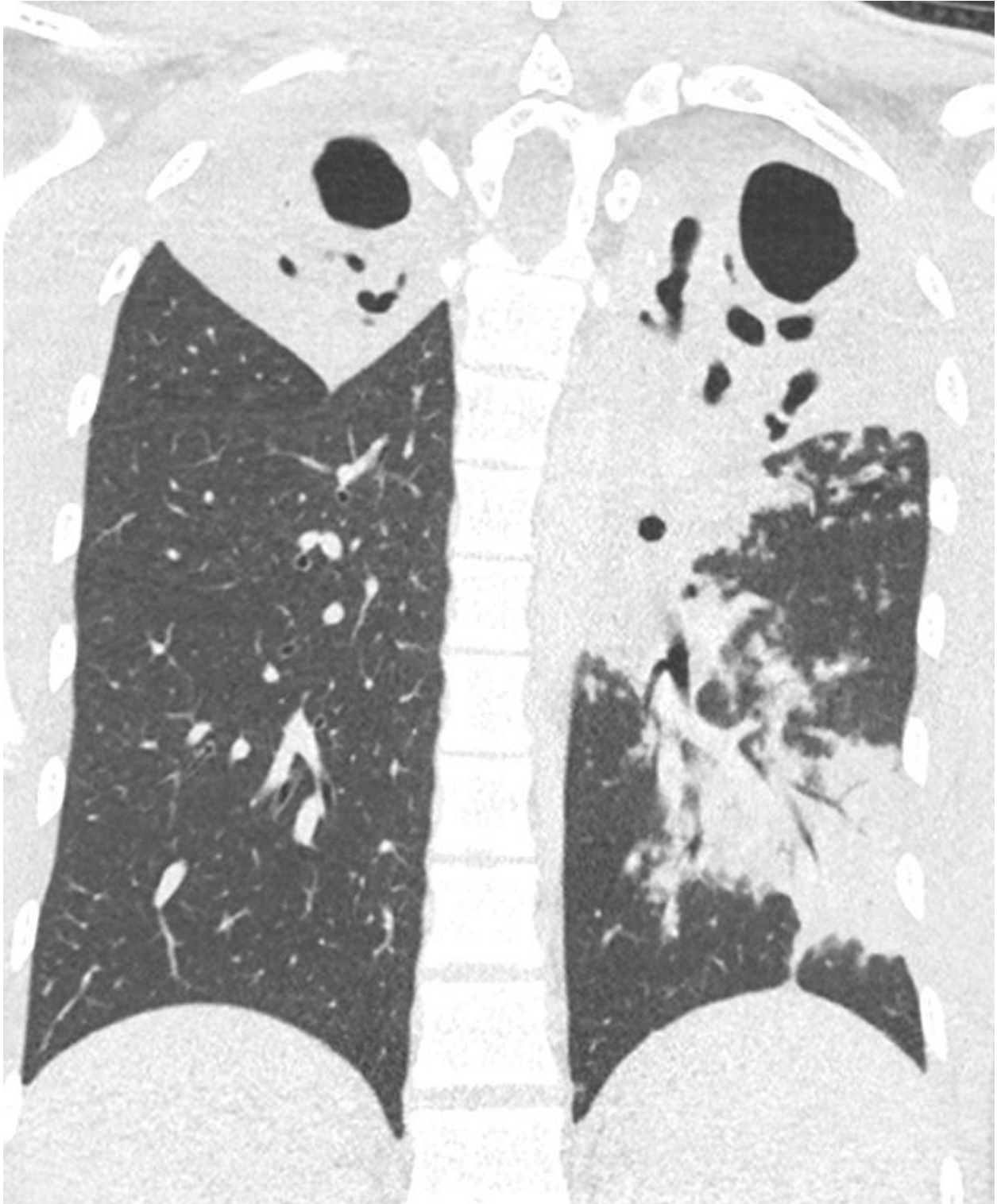

Learning Points/Discussion: This case shows that extensive and contagious pulmonary TB forms are still present in countries considered to have a low burden of disease and healthcare professionals should be aware of this diagnosis.

EP324 / #1338

Topic: AS09. *Mycobacteria and retroviruses / AS09.a. Tuberculosis and other mycobacterial infections*

PEDIATRIC TUBERCULOSIS IN ALGARVE: A 10 YEAR CASE SERIES

E-Posters

E-POSTER VIEWING

Mafalda Pereira, Íris Oliveira, Andreia Fernandes, Marta Amado, Maria Virtuoso
Centro Hospitalar Universitário do Algarve, Pediatric Department, Faro, Portugal

Title of Case: PEDIATRIC TUBERCULOSIS IN ALGARVE: A 10 YEAR CASE SERIES

Background: Tuberculosis (TB) is a major cause of childhood morbidity and mortality. Pediatric diagnosis is challenging due to variable clinical presentations. Accurate statistics of childhood TB are difficult to accomplish for several reasons, especially in developing countries, including underdiagnosis and underreporting. Objective: To characterize pediatric TB cases admitted to Algarve's Hospitals.

Case Presentation Summary: Methods: A retrospective descriptive study of hospital admissions under 18 years old, with TB, between January 2011 and August 2021. Results: 20 children were admitted with the TB diagnosis. The average age was 11.1 years old, with a minimum age of 4 months old. The mean hospitalization duration was 19.6 days. Positive contact history was identified in 11 cases (55%). The highest number of admissions was in 2017, with 4 cases. Of the hospitalized children, 11 were Portuguese (55%), 4 African (20%), 3 Asian (15%), 1 South American and 1 European. Pulmonary TB was identified in 80% of cases, with 1 disseminated case, 1 abdominal TB and 1 case of lymphadenitis. The most prevalent symptoms were fever (60%), cough (55%) and weight loss (30%), with 2 asymptomatic cases (10%). Diagnosis was obtained by nucleic acid amplification test in 40% of cases, in pulmonary or gastric secretions or adenopathy aspirate. 65% of the cases were treated with quadruple combination therapy. Follow-up was performed in Pneumological Diagnostic Centers in 17 cases (85%), 1 death was recorded.

Learning Points/Discussion: Pulmonary TB was the most frequent diagnosis, similarly to world statistics. While weight loss is described as the most frequent symptom worldwide, fever was the most prevalent symptom in this series. Preventing TB infection is a priority, and the most effective way is through rapid diagnosis and initiation of effective therapy.

EP325 / #1867

Topic: AS09. *Mycobacteria and retroviruses / AS09.a. Tuberculosis and other mycobacterial infections*

CAVERNOUS PULMONARY TUBERCULOSIS IN A CHILD – CASE REPORT

E-Posters

E-POSTER VIEWING

Katerina Boshkovska¹, Gorica Popova², Olga Spasova¹, Ivana Arnaudova¹, Irena Cakalarovska¹, Dragan Dacevski¹

¹Institute for respiratory diseases in children, Department For Tuberculosis, Skopje, North Macedonia, ²Institute for respiratory diseases in children, Department For Microbiology, Skopje, North Macedonia

Title of Case: Cavernous pulmonary tuberculosis in a child

Background: Tuberculosis (TB) as an infectious bacterial disease caused by *Mycobacterium tuberculosis*. Smear positive cases are the main source of the infection. In children, TB usually develops as a result of close family contact with TB patient. Diagnosis of TB in children is based on data about the history of the disease, epidemiologic data, clinical signs, laboratory analyses, x-ray examinations and immunologic examinations, tuberculin skin test (TST) and Interferon-Gamma Release Assays (IGRA) tests, while the unique secure proof for correct diagnosis is isolation of the causer from biologic material.

Case Presentation Summary: We present a case of cavernous pulmonary TB in a 8 years old girl, who was admitted to our hospital because of fever , cough , malaise , 10 days before. On auscultation she had absent breathing on the left side in the apical parts. She didn't have BCG scar. No contact with TB. From investigations: Normal blood count, CRP -55mg/l, normal hepatic enzymes, abdominal ultrasound normal, chest X ray - cystic formation with parenchymal inflammation in the right upper lobe, connected with the hilus. CT finding suggestible for pulmonary abscess or cavernous tuberculosis. Sputum smear positive for *Mycobacterium tuberculosis*, Gene X pert positive, Mantoux test negative. We started therapy with INH/RMP/PZA/EMB. Her condition ,the Xray and laboratory findings improved, and sputum smears and culture were negative after 2 months. We continued with INH/RMP for 4 months. We followed the patient for a year, and she was in good condition and without respiratory problems.

Learning Points/Discussion: Conclusion : Tuberculosis is a significant health problem among children population worldwide. Timely diagnosis and treatment are the basis for successful outcome and prevention of further spread of the disease.

EP327 / #1790

Topic: *AS09. Mycobacteria and retroviruses / AS09.a. Tuberculosis and other mycobacterial infections*

TUBERCULOUS PLEURISY BY ISONIAZID RESISTANT M. TUBERCULOSIS IN A FEMALE ADOLESCENT

E-Posters

E-POSTER VIEWING

Vasileios Tsagris, Alexandra Athanasopoulou, Anastasia Manoli, Marina Letsiou, Patra Koletsi
Penteli General Children's Hospital, Paediatrics, Athens, Greece

Title of Case: Tuberculous pleurisy by isoniazid resistant M.tuberculosis in a female adolescent

Background: Tuberculous pleurisy(TP) is the commonest form of extrapulmonary tuberculosis in Europe, representing 10-20% of total cases. In children, TP remains a diagnostic and therapeutic challenge due to the low sensitivity of available diagnostic tools. Resistance to isoniazid is the commonest type of anti-TB drug resistance. New guidelines regarding treatment of isoniazid resistant TB(Hr-TB) have been recently introduced by both WHO and ATS/IDSA/CDC, with key recommendation of using rifampicin, ethambutol, pyrazinamide and levofloxacin (REZL) for 6 months.

Case Presentation Summary: A 12-year-old female was admitted due to one-month history of fever and chest pain. CXR and CT demonstrated significant right pleural effusion with right lower lobe atelectasis. Mantoux test and QFT were positive. Thoracentesis revealed exudate with low ADA. Microbiological studies for mycobacteria in both pleuritic fluid and induced sputum were negative. Father's sputum was positive for M. tuberculosis in both cultures and molecular studies. Anti-Tb treatment was started (4 months HRZE followed by 2 months HR) with additional prednisolone for 6 weeks. Father's phenotypic DST and line probe assays (MTBDRplus) revealed isoniazid resistance associated with katG S315T mutation. Hence, isoniazid was discontinued and a 6-month REZL regimen was initiated. Follow-up was uneventful with rapid resolution of pleural effusion and no significant treatment related adverse events.

Learning Points/Discussion: Use of corticosteroids in TP remains a controversial issue, with the majority of studies demonstrating rapid resolution of pleural effusion while the long-term outcome remains unaffected. ADA represents a useful diagnostic biomarker, however in the early stages of disease sensitivity may be low. Further studies are needed to determine the clinical significance of isoniazid resistance mutations (esp.katG), in Hr-Tb patients receiving the newer, levofloxacin containing, WHO/CDC regimens.

EP328 / #1081

Topic: AS09. *Mycobacteria and retroviruses / AS09.a. Tuberculosis and other mycobacterial infections*

TUBERCULOSIS MIMICKING AS CROHN'S DISEASE: A CASE REPORT

E-Posters

E-POSTER VIEWING

Elizabeth Feenstra¹, Nicolette Moes¹, Yentl Driesen², Nathalie Jouret¹, Koen Vanden Driessche¹

¹University Hospital Antwerp, Pediatrics, Edegem, Belgium, ²ZNA Jan Palfijn/Stuivenberg, Pediatrics, Merksem, Belgium

Title of Case: Tuberculosis

Background: Patients with immune deficiencies and young children are susceptible to disseminated forms of tuberculosis. The presentation of disseminated TB is diverse depending on the affected organs and can mimic other disease.

Case Presentation Summary: An 11-year old boy with anaemia and increased calprotectin was referred for a colonoscopy because of abdominal pain, diarrhoea and weight loss for three months. Colonoscopy revealed ileocecal inflammation suggestive of Crohn's disease. After the procedure he developed fever and respiratory symptoms (dyspnea, crackles and reduced oxygen saturation). Chest X-ray demonstrated alveolar consolidations and a reticular enhanced lung parenchyma. With the working diagnosis of aspiration pneumonia amoxicillin/clavulanic was initiated. In the absence of improvement treatment was switched to ceftriaxone/metronidazole after 4 days and to meropenem 3 days later. Gradual clinical and biochemical improvement was noted. Gastro-intestinal biopsies showed chronic inflammation with multiple granuloma's, however not suspected of Crohn's disease. Tuberculosis was in the differential diagnosis. Because of persistent gastro-intestinal symptoms corticosteroids were initiated together with precautionary concurrent TB treatment. All investigations for TB (TST, IGRA, cultures on blood/liquor/gastric/BAL and PCR's on liquor and faeces) were negative. A positive evolution was noted on a CT scan, but residual abnormalities could be explained by TB. Two months after presentation the TST of his 10-month-old sibling turned positive, indicating recent family exposure to open tuberculosis. Corticosteroids were tapered to stop and TB treatment was continued for 9 months.

Learning Points/Discussion: Intestinal tuberculosis can mimic Crohn's disease. While improvement on antibiotics can be used as an argument against tuberculosis, physicians should be aware of meropenem's activity against tuberculosis. TST conversion in a family member indicates recent TB exposure, a so-called sentinel event, which can help confirming the diagnosis if all other investigations return negative.

EP329 / #799

Topic: AS09. *Mycobacteria and retroviruses / AS09.b. HIV/AIDS*

LIVER FIBROSIS AND STEATOSIS IN HIV-INFECTED CHILDREN RECEIVING DIFFERENT ANTIRETROVIRAL TREATMENT REGIMENS.

E-Posters

E-POSTER VIEWING

Anna Dobrzeniecka¹, Maria Pokorska-Śpiewak^{1,2}, Magdalena Marczyńska^{1,2}

¹Regional Hospital of Infectious Diseases in Warsaw, Department Of Children's Infectious Diseases, Warsaw, Poland, ²Medical University of Warsaw, Department Of Children's Infectious Diseases, Warsaw, Poland

Backgrounds: HIV infection itself and several antiretroviral drugs may lead to hepatopathy. The aim of this study was to analyze the prevalence of liver fibrosis and steatosis in children with HIV infection receiving different antiretroviral treatment (ART).

Methods: In this cross-sectional study, HIV-infected pediatric patients were included between March 2021 and July 2021. Children were divided into groups depending on the regimen of ART. Liver fibrosis (liver stiffness measurement, LSM) and steatosis (controlled attenuation parameter, CAP) were assessed using transient elastography and compared to the clinical and laboratory data.

Results: There were 48 participants (26 male) aged 4 to 19 years, including 47 infected vertically. In 33 participants, ART included integrase inhibitor (INSTI), in 7 protease inhibitor (PI), and in remaining 8 only nucleoside and non-nucleoside reverse transcriptase inhibitors. In 5/48 (10%) of patients, significant fibrosis ($F \geq 2$) was revealed, including 1 patient with cirrhosis (coinfected with HCV). Ten patients (20%) presented with steatosis, including 7 patients with S1 (mild), 2 with S2 (moderate), and 1 with S3 (severe). No significant influence of any ART regimen on the appearance of fibrosis or steatosis was found, however, there was a trend towards more frequent liver fibrosis in children receiving PI ($p=0.09$). CAP correlated with the body mass index (BMI) and BMI z-score ($p < 0.0001$ and $p=0.03$, respectively), alanine aminotransferase activity ($p=0.007$), and participant's age ($p=0.0005$). LSM correlated with BMI ($p=0.004$), and trends towards correlation between LSM and age as well as BMI z-score ($p=0.05$ and $p=0.07$) were found.

Conclusions/Learning Points: A significant proportion of HIV-infected children present with liver steatosis and fibrosis, which seem to result from metabolic factors. No evident correlation between different ARV regimens and liver disease was found.

EP331 / #668

Topic: AS09. *Mycobacteria and retroviruses / AS09.b. HIV/AIDS*

CHALLENGES FOR PROVIDING ANTIRETROVIRAL THERAPY (ART) IN CHILDREN LIVING WITH HUMAN IMMUNODEFICIENCY VIRUS (CLHIV) INFECTION IN INDIA

E-Posters

E-POSTER VIEWING

Suchit Kamble¹, Kalyani Nikhare¹, Nilesh Gawde², Vinita Verma³, Neha Kapoor³, Chinmoyee Das⁴
¹ICMR - National AIDS Research Organization, Pune, Epidemiology, Pune, India, ²Tata Institute of Social Sciences, Centre For Public Health, School Of Health Systems Studies, Mumbai, India, ³National AIDS Control Organization, New Delhi., Evaluation And Research, Delhi, India, ⁴National AIDS Control Organization, New Delhi., Cst, Si & Dnrt, Delhi, India

Backgrounds: In India, around 81165 (3.5%) children (<15 years) are living with HIV (CLHIV) and 10% of the total new HIV infections are estimated among children (2020). Hence, pediatric Antiretroviral Therapy (ART) services have special considerations in terms of the availability of an ART specialist pediatrician, special ART formulations, and different dosage formulations. This study was conducted to identify factors associated with the availability and utilization of pediatric ART services across 11 states in India.

Methods: A total of 33 in-depth interviews (IDIs) were conducted with medical officers and counselors from 20 ART centres (2018-2019). Thematic analysis was conducted using Atlas Ti V6.1 software and key themes representing the underlying factors affecting utilization of pediatric ART services were identified.

Results: The factors affecting the utilization of pediatric ART services were categorized into individual level, system level, and social level. Individual-level factors consist of lack of perceived need of pediatric ART among caregivers, financial problems, long-distance travel, poor support from male partner and family, death of parents, health issues of parents, health-seeking behaviour of caregivers, migration for livelihoods, and multiple visits due to non-availability of drugs and laboratory services at ART centres. Parents also discontinued the ART treatment because of pill burden, bitter taste, side effects of drugs, and opportunistic infections. Poor parental adherence to ART was positively associated with adherence to ART among children living with HIV. System-level factors affecting the pediatric ART services were limited ART centres for pediatric patients, long waiting time, poor counseling, lack of trained medical officers, drug stock-outs, and poor follow-up mechanisms. Social-level factors - stigma and discrimination also negatively impacted adherence to ART treatment.

Conclusions/Learning Points: Pediatric ART services in India need to be scaled up by implementing innovative and effective multi-factorial strategies.

EP332 / #1920

Topic: AS09. *Mycobacteria and retroviruses / AS09.b. HIV/AIDS*

LATE DIAGNOSIS OF HIV INFECTION

E-Posters

E-POSTER VIEWING

Magdalena Pluta^{1,2}, Marta Lipińska^{1,2}, Maria Pokorska-Śpiewak^{1,2}, Magdalena Marczyńska^{1,2}

¹Medical University of Warsaw, Poland, Department Of Children's Infectious Diseases, Warsaw, Poland, ²Warsaw's Hospital for Infectious Diseases, Department Of Children's Infectious Diseases, Warsaw, Poland

Title of Case: LATE DIAGNOSIS OF HIV INFECTION

Background: Having a sexually transmitted disease (STD) increases the risk of HIV infection. Damage to the skin and mucosal barrier can facilitate the transmission of HIV. Symptoms of HIV in teens may be similar to those commonly seen in adults with HIV. We present a 16-year-old boy with syphilis and recently diagnosed HIV, who abruptly deteriorated due to brain oedema.

Case Presentation Summary: A teenage, HIV-positive boy (MSM) presented initially with maculopapular rash with lymphadenopathy, malaise, flu-like symptoms, wasting syndrome and headache. He was recently treated for syphilis and referred to hospital to start ARV treatment. Laboratory tests revealed HIV VL of 207 963 copies/ml, CD4 count of 396 (14%). PCR testing was positive for EBV. IGRA test was negative. US of the abdomen and neck, chest X-ray showed generalized lymphadenopathy. On the 2nd day of his admission he started complaining of headache and vomiting, he had bradycardia. Urgent head MRI revealed focal lesions with oedema of neighbouring tissues, interrupting flow, resulting in increased intracranial pressure. He was referred to neurosurgery unit with suspicion of lymphoma/toxoplasmosis and brain herniation. Brain biopsy confirmed lymphoma, but was complicated by intracerebral haemorrhage and tetraplegia. Chemotherapy was started.

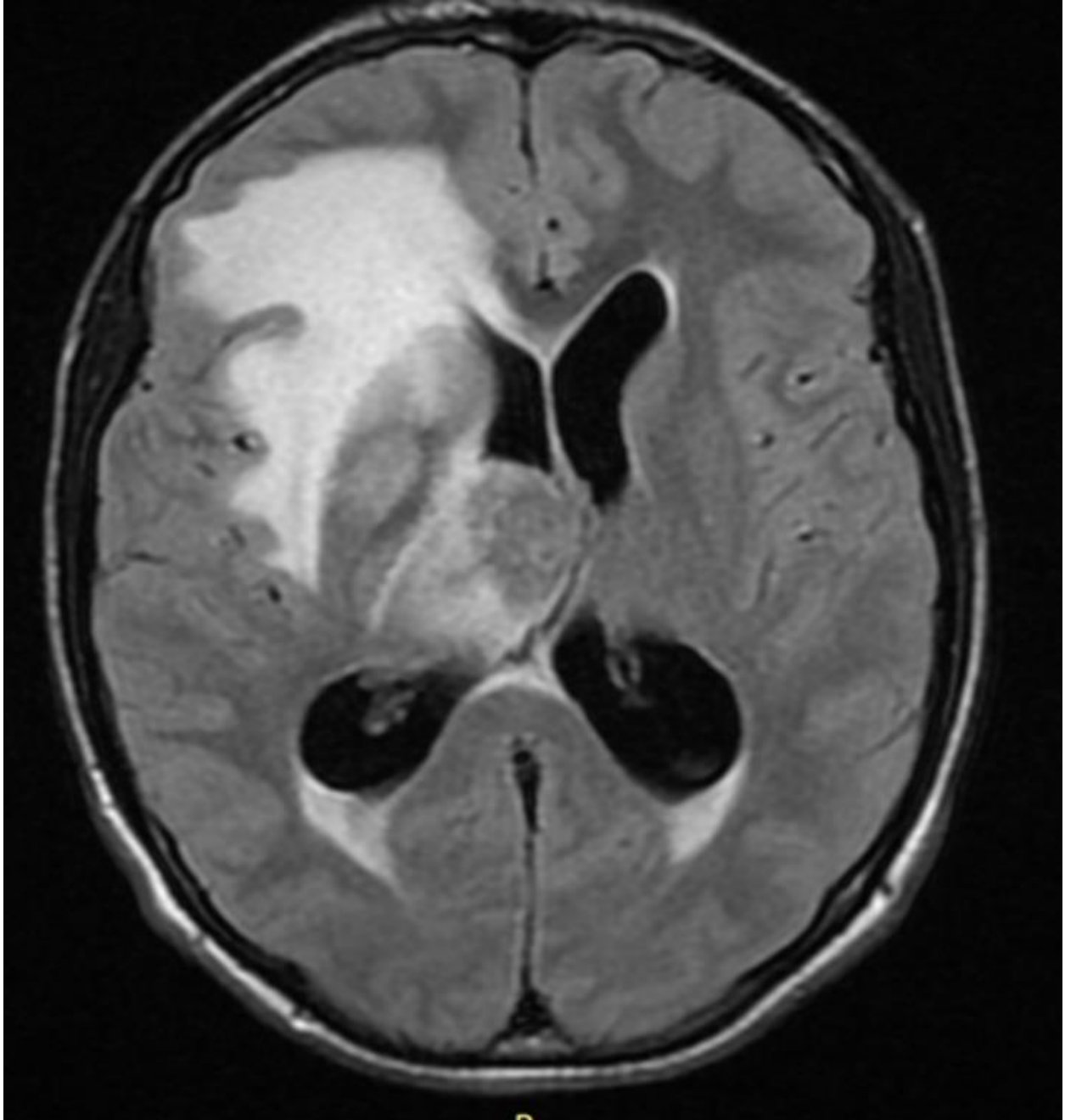

Learning Points/Discussion: HIV testing should be offered and advised to sexually active adolescents considering the specific health needs of the key populations. Safeguarding young people is the responsibility of all healthcare. EBV in PLWH significantly increases the risk of malignant lymphoproliferation .

Topic: AS09. *Mycobacteria and retroviruses / AS09.b. HIV/AIDS*

POST-EXPOSURE PROPHYLAXIS TRENDS AMONG YOUTHS IN SPAIN

E-Posters

E-POSTER VIEWING

Paula Rodriguez Molino¹, Clara Nieto¹, Rosa Lopez¹, Eva Soria¹, Carmen Busca², Rafael Micán Rivera², Luis Escosa-García¹, Luz Martín Carbonero², Eulalia Valencia Ortega², María Luisa Montes², Ana Delgado², Juan González-García², Jesus Dominguez¹, Carlos Grasa¹, Talia Sainz¹
¹La Paz University Hospital, Pediatrics And Infectious Diseases, Madrid, Spain, ²La Paz University Hospital, Infectious Disease, Madrid, Spain

Backgrounds: Post-exposure prophylaxis (PPE) reduces HIV infections after a risk exposure. Despite risky behaviors are common during adolescence, data are scarce in this population. We analyze the indications, clinical characteristics and follow-up of PPE in children and young adults under 24 years.

Methods: Retrospective observational study in a tertiary hospital. Patients <24 years evaluated after a risk exposure over a period of 10 years (2011-2020) were included. Longitudinal data from first visit to the end of follow-up were collected.

Results: 339 patients were evaluated, 57% women, median age 18 (11-21) years: 25% <12 years, 18% 12-16 years and 57% >16 years. The number of patients attended increased significantly during the study period (Figure). 96% corresponded to sexual contacts: vaginal penetration (47%), anal penetration (35%). 12.7% of cases corresponded to condom breaks. 59.7% were non-consensual: 76% included physical violence, 24% any psychoactive substance. Median time until consultation was 24h [18-55]. Delay in medical consultation (>72 hours) occurred in 62% of minors. PPE was indicated in 17% <12 years, 57% between 12-16 years and 72% >16 years. Most common regimen included TDF/FTC+Raltegravir (78%). Among patients with follow-up, adherence was 96%. Side effects occurred in 16% of cases, and led to the suspension of the PPE in 20% of them. During follow-up, there were no cases of HIV infection.

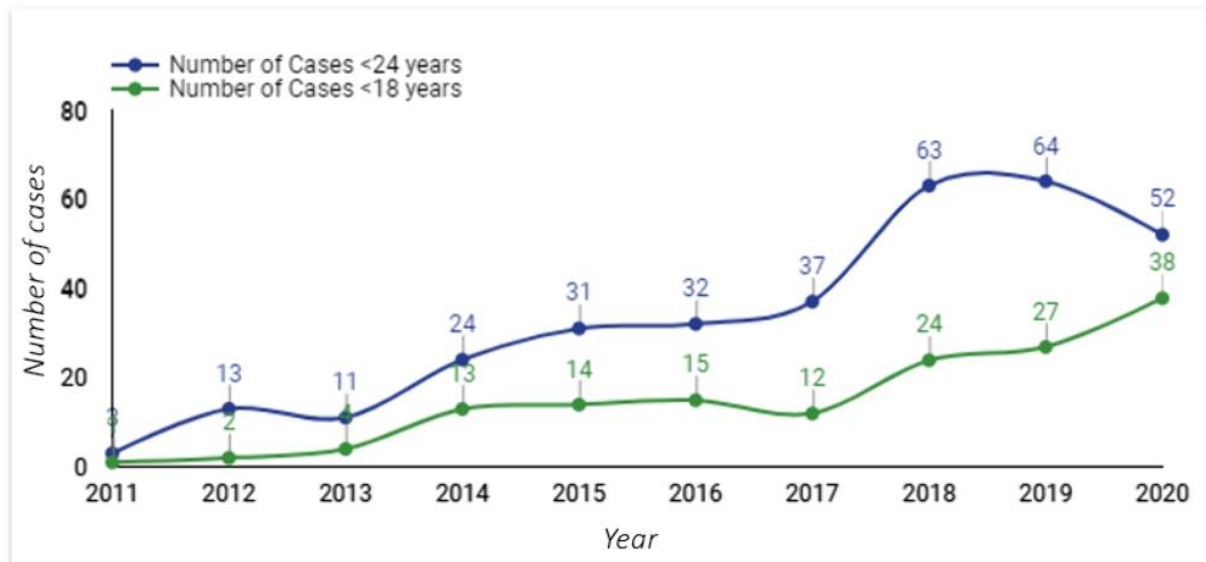

Figure 1: Patients younger than 24 years (blue) and patients younger than 18 years (green) attended after risk contacts between 2011 and 2020

Conclusions/Learning Points: Increasing rates of PEP were observed during the study period among youths in Spain. Delay in consultation impairs treatment specially among children and adolescents. 1/2 of

episodes involved non-consensual relationships and physical violence, which imply an increased risk for sexual transmission of HIV. Although adverse events were not uncommon, they rarely led to treatment interruption; adherence to treatment was good, and no new HIV infections were reported.

EP334 / #1333

Topic: AS09. *Mycobacteria and retroviruses / AS09.b. HIV/AIDS*

MATERNAL ART IN BREASTFED HIV-EXPOSED, UNINFECTED CHILDREN – ANY ADVERSE EFFECTS?

E-Posters

E-POSTER VIEWING

Benedikt Spielberger¹, Susanne Usadel², Markus Hufnagel¹, Jan Rohr¹, Philipp Henneke¹

¹Center for Pediatrics and Adolescent Medicine, University Medical Centre And Faculty Of Medicine Freiburg, Freiburg im Breisgau, Germany, ²MVZ Clotten, Praxis Für Infektionsmedizin Freiburg, Freiburg im Breisgau, Germany

Backgrounds: Adherence to anti-retroviral therapy (ART) and negative maternal HIV viral load successfully prevent intrauterine and perinatal HIV infection in children. Yet, data on adverse effects in HIV exposed, uninfected children postnatally exposed to ART through breast milk, especially integrase inhibitors (INI), are lacking.

Methods: Seven HIV-exposed, uninfected children who were breastfed by their mothers were prospectively followed-up. The mothers' ART contained either abacavir/lamivudine (N=2) or tenofovir/emtricitabine (N=5) in combination with rilpivirin (N=3), dolutegravir (N=2), darunavir/r (N=1) or nevirapine (n=1). Infants and mothers were followed closely while breastfed by sequentially performing HIV-PCR, full blood count and serum levels of ART in infants. ART concentration in breast milk was measured when samples were available.

Results: ART concentrations in breast milk and infants were highly heterogeneous, showing supratherapeutic levels of rilpivirin and dolutegravir in some infants, while darunavir/r and nevirapin never reached therapeutic levels. No elevation of liver enzymes or creatinine was observed. Full blood counts were compared with HIV-exposed formula-fed infants from 2012-2020 (N=62). No differences in hemoglobin levels and thrombocyte counts were observed. Neutrophil counts dropped in all infants irrespective of feeding mode around four months of age. At this age, 33% of breastfed infants had neutrophil < 1.000/ μ l, compared to 15% of formula-fed infants. No HIV infections were observed in both groups.

Conclusions/Learning Points: Breastfeeding of HIV-exposed, uninfected children is feasible when ART adherence is high and viral load in mothers remains negative. No differences in liver enzymes or hemoglobin levels were observed in breastmilk as compared to formula fed infants. Neutrophil counts dropped in all infants around four months of age, with slightly lower values in the breastmilk group.

EP335 / #1913

Topic: AS09. *Mycobacteria and retroviruses / AS09.b. HIV/AIDS*

PERINATAL HUMAN IMMUNODEFICIENCY VIRUS INFECTION IN 4 MONTHS OLD INFANT WITH AIDS ASSOCIATED CONDITIONS.

E-Posters

E-POSTER VIEWING

Inga Ziemele¹, Santa Ansone², Amanda Freimane¹, Vija Rimša¹, Jana Pavare³, Dace Gardovska³
¹Children's Clinical University Hospital, Pediatric Department, Riga, Latvia, ²Riga East University Hospital, Latvian Centre Of Infectious Diseases, Riga, Latvia, ³Riga Stradins university, Department Of Pediatrics, Riga, Latvia

Title of Case: PERINATAL HUMAN IMMUNODEFICIENCY VIRUS INFECTION IN 4 MONTHS OLD INFANT WITH AIDS ASSOCIATED CONDITIONS.

Background: Most human immunodeficiency virus (HIV) infections in children are acquired via mother-to-child transmission. In developed countries, 15 - 25% of HIV-infected newborns present a clinical course as a rapid progression with onset of acquired immune deficiency syndrome (AIDS) and symptoms during the first few months of life.

Case Presentation Summary: A 4-month-old boy was admitted to the hospital with a 5-days history of cough, febrile temperature, poor appetite, and petechial rash for the last 4 days. He was apathic, his respiratory rate was 60 breaths/min, heart rate 160 beats/min, SpO₂ without the oxygen therapy was 88%. In physical examination oral thrush, bilateral crackles by lung auscultation, hepatomegaly and neck stiffness were diagnosed. Laboratory findings revealed anemia, thrombocytopenia and pleocytosis with 69.1% of mononuclear cells. Chest X-ray showed bilateral infiltrations and cerebrospinal fluid as well as blood sample was positive for cytomegalovirus (CMV) DNA. *Candida albicans* was tested to be positive in oral swab and stool, but blood sample was positive for *Candida* antigen (Ag). Consequently, the result of HIV1/2 antibodies and HIV1 Ag showed positive. In evaluation, nasopharyngeal swab was positive for *Pneumocystis jirovecii* DNA and CD4+ count was 600 cells/mm³ (22.75%). Patient was introduced with antiretroviral therapy (ART) on the 3rd week of hospitalization. In addition, he received ganciclovir, sulfamethoxazole/trimethoprim and fluconazole. After 2.5 months of ART, he developed BCG-related local tuberculosis, antimycobacterial treatment was started. Patient was discharged from the hospital at the age of 1 year in stable condition.

Learning Points/Discussion: This clinical case presents a rapid progression of previously undiagnosed perinatal HIV infection. In approach to patients with various clinical presentations, evaluation of HIV infection is highly recommended.

EP336 / #839

Topic: AS10. Digital tools and machine learning / AS10.a. Decision support tools

EVALUATION OF MACHINE LEARNING TO DETECT ADVENTITIOUS LUNG SOUNDS USING DIGITAL AUSCULTATION TO AID CHILDHOOD PNEUMONIA DIAGNOSIS

E-Posters

E-POSTER VIEWING

Salahuddin Ahmed¹, Harish Nair², Steve Cunningham³, Abdullah Baqui⁴, Eric Mccollum⁵

¹Projahnmo Research Foundation, Research, Dhaka, Bangladesh, ²Usher Institute, Edinburgh medical School, University of Edinburgh, Centre For Global Health, Edinburgh, United Kingdom, ³University of Edinburgh, Centre For Inflammation Research, Edinburgh, United Kingdom, ⁴Johns Hopkins Bloomberg School of Public Health, International Health, MD, United States of America, ⁵Johns Hopkins University, Eudowood Division Of Pediatric Respiratory Sciences, Department Of Pediatrics, MD, United States of America

Backgrounds: IMCI guidelines for childhood pneumonia diagnosis have high sensitivity but low specificity. A digital stethoscope with an automated machine-learning algorithm for classifying lung sounds may improve diagnostic performance. We aimed to evaluate agreement between digital stethoscope recorded lung sound classifications generated from an automated machine learning algorithm with a paediatrician listening panel from children receiving care at community clinics in rural Bangladesh.

Methods: In a cross-sectional design, government community health workers recorded lung sounds from four chest positions using a novel digital stethoscope in children under-5 with cough and/or difficult breathing at first-level community clinics in Bangladesh from November 2019 to December 2020. A trained paediatrician listening panel classified recorded lung sounds into normal, crackles, wheeze, crackles and wheeze, or uninterpretable. A machine learning algorithm classified recorded sounds into the same categories, which were compared with panel classifications.

Results: Of 2434 children screened, 990 were enrolled. Compared to paediatricians, the sensitivity, specificity, and positive and negative predictive values of detecting abnormal sounds (wheeze and/or crackles) by the machine learning algorithm were 61.8 (95%CI: 55.7, 67.6), 60.7 (56.6, 64.6), 41.8 (36.9, 46.8), and 77.6 (73.6, 81.3) among all enrolled children, and 63.5 (54.5, 71.9), 66.2 (60.1, 73.1), 52.7 (44.4, 60.8), and 75.9 (69.2, 81.8) among children with IMCI defined pneumonia.

Conclusions/Learning Points: This study shows an automated algorithm had moderate sensitivity and specificity for classifying lung sounds as either abnormal or normal when using a paediatric listening panel as the reference. Agreement between the machine learning algorithm and paediatric listening panel modestly increased among children with IMCI-defined pneumonia.

DETECTING CLINICALLY SIGNIFICANT EFFECT OF A DEMOGRAPHIC ATTRIBUTE ON PROBABILITY OF DISEASE AND VACCINE EFFICACY

E-Posters
E-POSTER VIEWING

Julie Dudasova^{1,2}, Garrett Nieddu³, Katerina Zelinkova⁴, Alexander Becker³, Jeffrey Sachs³
¹MSD Czech Republic, Quantitative Pharmacology And Pharmacometrics, Prague, Czech Republic, ²Charles University, First Faculty Of Medicine, Prague, Czech Republic, ³Merck & Co., Inc., Quantitative Pharmacology And Pharmacometrics, Kenilworth, United States of America, ⁴MSD Czech Republic, Data Science And Scientific Informatics Prague, Mrl It, Prague, Czech Republic

Backgrounds: Vaccine efficacy (VE) assessed in phase 3 trials can be affected by demographic attributes (covariates) of the enrolled population, e.g., age, gender, or pre-vaccination serostatus. Statistical significance of covariate effects on the clinical outcome (diseased versus non-diseased) is often evaluated by Cox proportional hazard model or logistic regression. It has been shown, e.g., via the Probability of Disease Bayesian Analysis (PoDBAY) framework, that if immune response post vaccination is a correlate of protection (CoP, defined as a biomarker that predicts VE reliably) then the resulting VE prediction is more precise than the case-count-based VE estimate.

Methods: The aim of this work is to develop a methodology to assess both the statistical and clinical significance of a single binary covariate effect (e.g., age group) on the clinical outcome using CoP-based estimation. Statistical and clinical significance is determined by integrating PoDBAY and Full Covariate Model approach, comparing CoP-based estimates of VE and its 95% confidence intervals (CI) for the subgroups (e.g., older and younger).

Repeat ~1000 times:

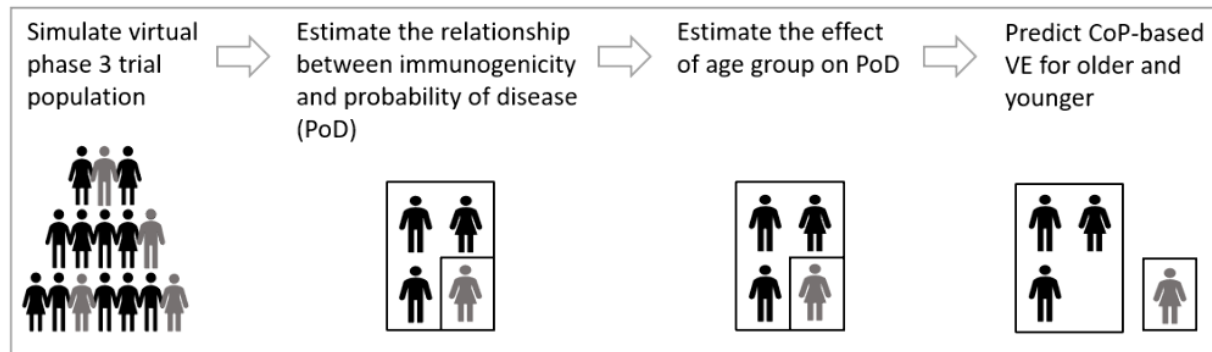

Results: Simulations show that, for a vaccine with 58% VE in older and 90% in younger (80% overall VE, in a population with 25% older), 95% of the time the CoP-based VE estimate is within 6% of the true overall VE and the effect of age group on VE is detected 85% of the time for a phase 3 trial (15,000 subjects, vaccinated:placebo; 2:1, 3% incidence).

Conclusions/Learning Points: CoP-based VE estimation can be used to detect the effect of a binary demographic attribute on VE. This approach can be extended to multiple attributes. Understanding attributes affecting VE is key to making informed decisions in the development of safe and effective vaccines.

EP338 / #1177

Topic: AS10. Digital tools and machine learning / AS10.a. Decision support tools

CONCORDANCE ON RESPIRATORY RATE EVALUATED THROUGH A VIDEO RECORDING IN CHILDREN WITH LOWER RESPIRATORY INFECTION

E-Posters

E-POSTER VIEWING

Angela Manzanares¹, Serena Villaverde¹, Sara Domínguez², Ana De La Rocha³, Ignacio Garrido³, Lorena Sánchez Marinero¹, Marcos Sánchez⁴, Jesús Gutiérrez⁴, Julián Cabrera⁴, Isabel Rodríguez⁴, Lola Madrid⁵, Pablo Rojo¹

¹HOSPITAL 12 DE OCTUBRE, Paediatrics, MADRID, Spain, ²HOSPITAL 12 DE OCTUBRE, Clinical Trials Unit, MADRID, Spain, ³UNIVERSIDAD COMPLUTENSE DE MADRID, Facultad De Medicina, Madrid, Spain, ⁴UNIVERSIDAD POLITÉCNICA DE MADRID, Information Processing And Telecommunications Center And Etsi Telecomunicación, Madrid, Spain, ⁵London School of Hygiene and Tropical Medicine, Department Of Infectious Disease Epidemiology, London, United Kingdom

Backgrounds: Respiratory distress is one of the most common causes of consultation at paediatric clinics. To establish its severity requires a clinician able to accurately determine the respiratory rate (RR). VIBRA project aim is to develop a smartphone application to evaluate respiratory distress severity as efficiently as a trained paediatrician through a video of the patient's chest and artificial intelligence algorithms. To validate the application, a previous study to determine the concordance between two trained paediatricians measuring the RR of paediatric patients was conducted.

Methods: Patients with respiratory infections < 10 years are included. Medical information and 1-3 videos of each patient are recorded and shared on REDCap platform. Two trained paediatricians evaluated and separately measured RR of videos included from November 2020-May 2021. Inter-observer concordance was measured with Bland-Altman method.

Results: 39 patients and 105 videos were included. Median age was 1.1 (IQR: 0.09-3.71) years and 20(51.3%) were women. Main diagnosis were bronchiolitis (19;48.7%), bronchospasm (12;25.6%), and low respiratory tract infections (7;10.3%). RSV (12;30.7%), Rhinovirus (8;20.5%) and Parainfluenza (4;10.3%) were the most frequent detected etiologies. 28(66.7%) patients needed hospitalization and 22(56.4%), oxygentherapy. In 93(88.5%) videos respiratory distress was seen. It was mild in 23(21.7%), moderate in 59(55.7%), and severe in 11(10.4%). Mean RR was 41.3(±11.7) for observer1 and 42.7(±11.6) for observer2. Mean difference between the two observers was -1.06 (-1.74;-0.38), without statistical significance. This difference was not modified by low or high RR. Concordance limits were -5.22-3.1%, and 95.1% of the observations were concordant between the two observers.

Figure 1. Bland-Altman Plot.

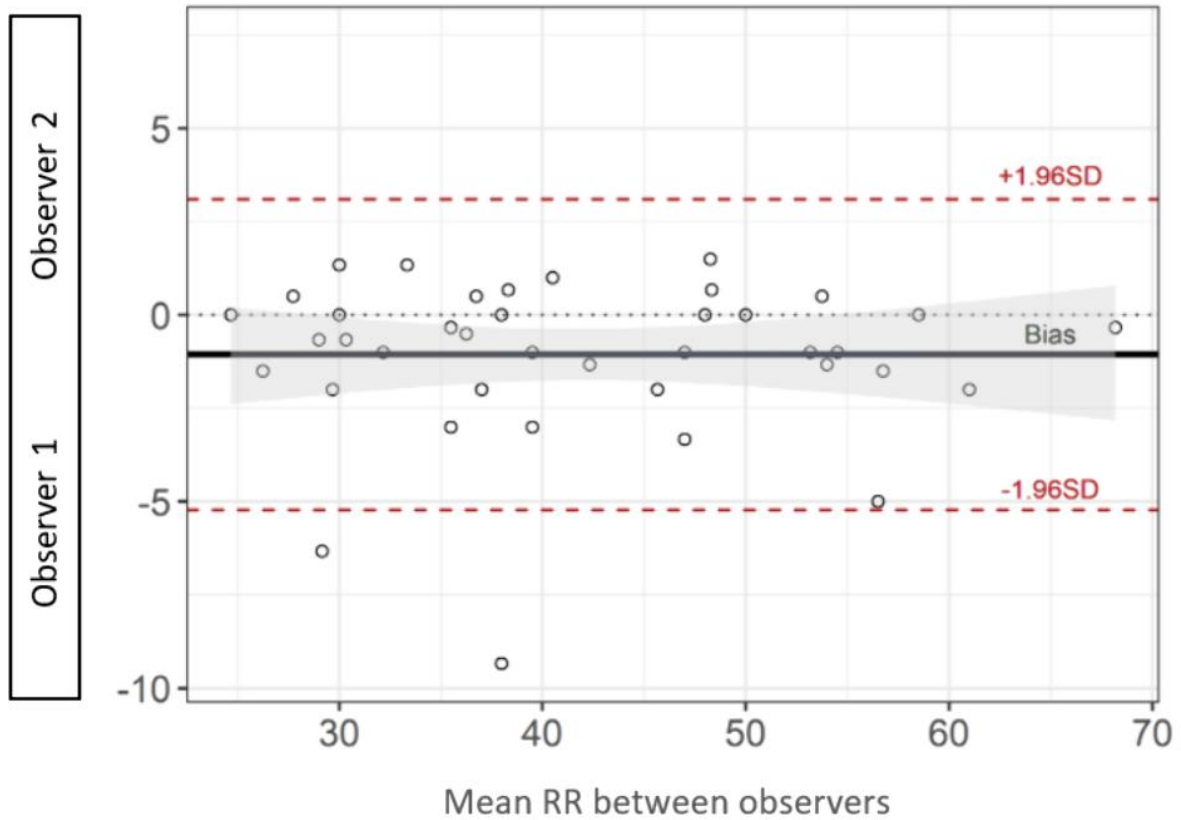

Conclusions/Learning Points: Results showed high concordance between two trained paediatricians for RR estimation in paediatric patients. This is the first step in order to validate a breath-rate measurement solution in the future.

EP339 / #462

Topic: AS10. Digital tools and machine learning / AS10.a. Decision support tools

THE ONLINE CATCH-UP IMMUNIZATION SCHEDULING TOOL FOR EUROPEAN COUNTRIES

E-Posters

E-POSTER VIEWING

Dominik Wawrzuta

Medical University of Warsaw, Department Of Education And Research In Health Sciences, Warsaw, Poland

Backgrounds: Many children in Europe are not fully vaccinated or were not vaccinated according to the national immunization schedules. Vaccinations are delayed mainly because of mild infections, COVID restrictions, travels, or migrations. Sometimes parents forget about vaccinations or have special preferences. In such situations, physicians have to create personalized catch-up immunization schedules. Pediatricians must spend a lot of time and take into account many rules and recommendations to create individual schedules manually. As a result, only a small percentage of improperly vaccinated children have access to optimal and safe catch-up immunization schedules.

Methods: We developed an online decision support tool that enables to automatically generate personalized catch-up immunization schedules for children. This website is based on optimization algorithms that use official recommendations, summaries of product characteristics, epidemiological situation, and the experience of vaccinology experts. Our algorithms also take into account children's vaccination history and parents' preferences on non-obligatory vaccines.

Results: We released our application in Poland in 2019. Our tool is mainly used by pediatricians, general practitioners, and nurses. They can automatically generate personalized catch-up immunization schedules in less than a minute, without extensive expert knowledge. In the last 2 years, the users created over 20 000 individual vaccination schedules for children.

Conclusions/Learning Points: We proved that decision support tools creating catch-up immunization schedules can be useful for physicians and nurses planning the immunization process in children. Although the tool is currently available only in Poland, our optimization algorithms are universal and can be adjusted to the national recommendations of each European country.

Topic: AS10. Digital tools and machine learning / AS10.c. Telemedicine

COMBATING NEONATAL SEPSIS IN DIFFICULT TO REACH TERRAINS OF CHHATTISGARH, INDIA: A QUALITY IMPROVEMENT INITIATIVE

E-Posters

E-POSTER VIEWING

Atul Jindal¹, Nikita Agarwal¹, Nitin Nagarkar², Sridhar Ryavanki³, Vishwanath Bhagat⁴

¹All India Institute of Medical Sciences, Raipur, Pediatrics, Raipur, India, ²All India Institute of Medical Sciences, Raipur, Ent, Raipur, India, ³UNICEF Chhattisgarh, Health Specialist, Raipur, India, ⁴State Programme Officer, Directorate Health Services, Child Health, Raipur, India

Backgrounds: Recent data from microbiological surveillance in the difficult-to-reach terrains reveal increased incidence of neonatal sepsis, morbidity and mortality related to it and emergence of multidrug resistant organisms in neonates admitted to special newborn care unit (SNCU). Our aim is to reduce incidence of neonatal sepsis in SNCUs and irrational antimicrobial usage by applying a hybrid of telemedicine, quality improvement (QI) package and supportive supervision visits.

Methods: Telemedicine and supportive supervision visits were conducted in Dantewada, Bijapur and Mahasamund from January 2021 to December 2021. During this time the staff working in these units was allocated QI projects after providing them with the necessary training in its practice. These projects were targeted towards reducing unnecessary intravenous fluid (IV) use, reducing irrational antimicrobial use and improving hand hygiene compliance. Monthly supportive supervision visits were made to monitor these projects. Opportunity was taken to hand-hold the staff on the weekly-discussed issues in the management of these neonates. $p < 0.05$ was considered significant.

Results: The data collected was analyzed in comparison to a centre (District Kondagaon) where this program was not being conducted and the following results were obtained.

| District | Proportion of deaths due to Sepsis |
|------------|------------------------------------|
| Mahasamund | 8.3% (p=0.009) |
| Bijapur | 5.8% (p=0.19) |
| Dantewada | 35.3% (<0.00001) |

Antimicrobial usage was reduced from 87.5% to 25% (p=0.03) in Dantewada and from 99.7% to 56.4% (p<0.00001) in Mahasamund. Bijapur achieved reduction in IV fluid usage from 80% to 50% (p=0.3).

Conclusions/Learning Points: Telemedicine along with QI package is a viable option to reduce both sepsis related morbidity and mortality in difficult-to-reach terrains where there is a lack of antimicrobial stewardship and danger of rise of pan-resistant organisms.

EP341 / #622

Topic: AS11. Diagnostics and biomarkers

ANTIBODY RESPONSE TO GROUP A STREPTOCOCCUS ANTIGENS: A STEP INTO THE MULTIVERSE

E-Posters

E-POSTER VIEWING

Rachael Barr^{1,2}, Elizabeth Oliver², Amy Thomas², Holly Baum², Alexandra Shaw³, Adam Finn², Alice Halliday², Anu Goenka^{2,4}

¹Bristol Royal Hospital for Children, Paediatrics, Bristol, United Kingdom, ²University of Bristol, Cellular And Molecular Medicine, Bristol, United Kingdom, ³The National Institute for Biological Standards and Control, Nibsc, London, United Kingdom, ⁴Bristol Royal Hospital for Children, Paediatric Immunology And Infectious Diseases, Bristol, United Kingdom

Backgrounds: Group A Streptococcus (GAS) infections drive significant global morbidity and mortality through a wide array of clinical manifestations including sepsis and rheumatic heart disease. There is no vaccine in part due to a limited understanding of the immune responses to GAS. We developed a suite of assays to quantify antibody responses to clinically important GAS antigens, by using sera collected from clinical groups with differing risks of GAS exposure

Methods: Development of enzyme-linked immunosorbent assays (ELISAs) to detect IgG and IgA antibodies to GAS antigens, selected by their conservation across serotypes and inclusion in candidate GAS vaccines

Results: Sera were obtained from 32 individuals: 6 infants aged 9-18 months (low-risk); 5 adult non-healthcare workers (medium-risk); 21 adult healthcare workers (high-risk). Serum anti-GAS IgG and IgA measurements were reproducible between technical replicates with a median coefficient of variability of 2.3% (IQR 0.8-4.6%). Specific antibody levels were significantly lower in low-risk individuals compared with high-risk individuals for all antigens (all p values at least <0.05, e.g. Fig.1). Moderate correlation was observed between IgG and IgA responses for all antigens (median $r^2=0.41$, Range 0.37-0.51, all p values at least <0.001). Moderate correlation was also observed between responses to different antigens (median $r^2=0.41$, IQR 0.26-0.45, all p values at least <0.03). No single antigen exhibited strong correlation ($r^2>0.5$) across all comparisons with other antigens

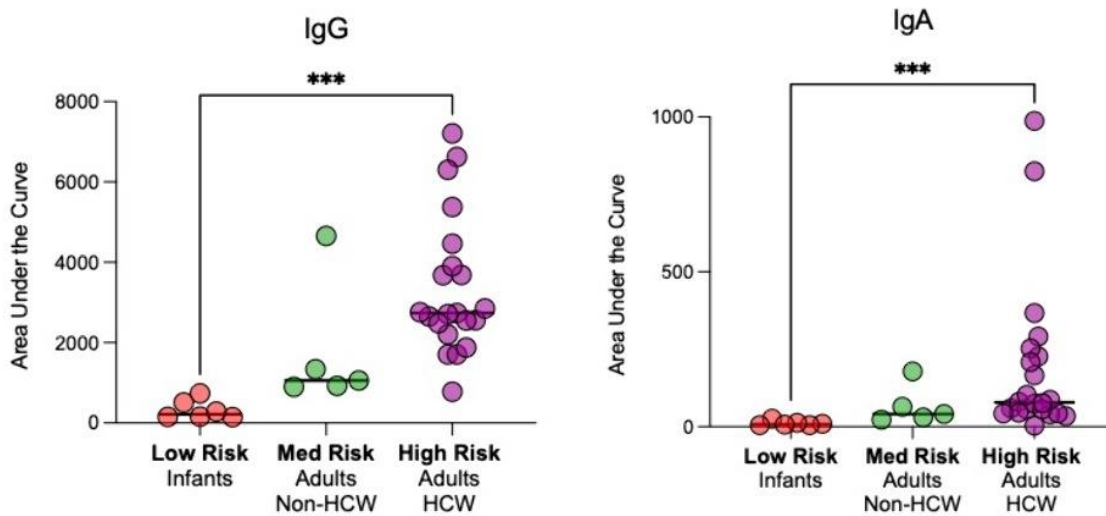

Figure 1. Serum IgG and IgA antibody responses to *Streptococcus pyogenes* cell envelope proteinase (SpyCEP) across clinical groups with differing exposure risk. Serum antibody measured by ELISA as six-point dilution curve. Bars represent median. The non-parametric Kruskal-Wallis test with Dunn's test for multiple comparisons was used to generate adjusted p values.

Conclusions/Learning Points: We developed a suite of novel reproducible assays capable of detecting significant differences in anti-GAS antibody levels across distinct clinical groups that differ by their exposure risk. To holistically understand the seroresponse to GAS infection for vaccine development, our data supports independent and multiplexed evaluation of IgG and IgA responses to multiple GAS antigens

Topic: AS11. *Diagnostics and biomarkers*

A MULTI-CENTER, PROSPECTIVE, RANDOMIZED CONTROLLED STUDY TO EVALUATE THE IMPACT OF FILMARRAY MENINGITIS/ENCEPHALITIS PANEL ON CLINICAL EFFICACY AND HEALTH ECONOMICS IN PEDIATRIC PATIENTS IN CHINA

E-Posters

E-POSTER VIEWING

Zhenzhen Dou¹, Yue Tao², Xiaoxiao Qin³, Lingyun Guo¹, Feng Huo⁴, Guangyuan Zhao⁴, Quan Wang⁴, Qing Cao², Gang Liu¹

¹Beijing Children's Hospital, Infectious Diseases Department, Beijing, China, ²Shanghai Children's Medical Center, School of Medicine, Shanghai Jiao Tong University, Infectious Diseases, Shanghai, China, ³Shanghai Medical Information Center, Shanghai Health Development Research Center, No, Shanghai, China, ⁴Beijing Children's Hospital, Emergency Department, Beijing, China

Backgrounds: Meningitis and encephalitis (ME) are life-threatening diseases in pediatrics, especially in infants and severe cases. Early, accurate and comprehensive etiological results may help reduce mortality and complications. This study is to evaluate the clinical and economic impacts of PCR-based FilmArray ME system (FA-ME) which can report 14 common pathogens within one hour

Methods: This was a prospective, randomized controlled study conducted in two Chinese children's hospitals. Suspected ME patients less than 18-year old were 1:1 randomized to FA-ME group or standard-of-care (SOC) group. Patients in both groups accepted conventional lab testing. In FA-ME group, patients' cerebrospinal fluid samples were additionally tested by FA-ME.

Results: Between October 2020 and June 2021, a total of 85 patients (45 in FA-ME group and 40 in SOC group) were included in a mid-term analysis. FA-ME detected 10 pathogens, including 8 bacteria and 2 HSV-1. For bacteria, the positive rates of FA-ME and culture were 17.8% (8/45) and 14.1% (12/85), respectively. *S. pneumoniae* was the most common bacterium detected by both methods. Although mean hospital length of stay (LOS) (18.16±9.08 days in FA-ME group vs. 19.28±9.54 days in SOC group, P=0.552) was not significantly different between two groups, patients in FA-ME group had significantly less total lab fee than patients in SOC group (6584.03±2842.91 vs. 8186.07±3101.74, P=0.015). In subgroup analysis, however, patients less than 1-year old and severe cases had significantly shorter LOS and antimicrobial days in FA-ME group compared to patients in SOC group.

| | | FA-ME group | SOC group | P value |
|---------------|--------------------|-------------|-------------|---------|
| Aged < 1-year | n | 12 | 9 | |
| | LOS (days) | 16.83±5.11 | 25.2±10.08 | 0.043 |
| | Antimicrobial days | 16.58±3.77 | 24.89±10.17 | 0.043 |
| Severe cases | n | 11 | 10 | |
| | LOS (days) | 20.27±7.64 | 28.00±8.04 | 0.036 |
| | Antimicrobial days | 18.36±7.54 | 27.60±8.30 | 0.015 |

Conclusions/Learning Points: The use of FilmArray ME system in suspected pediatric meningitis and encephalitis patients has potential clinical and economic values, especially in patients less than 1-year old and severe cases.

EP343 / #977

Topic: AS11. *Diagnostics and biomarkers*

POINT OF CARE SOFIA SARS ANTIGEN FLUORESCENT IMMUNOASSAY: RELIABILITY EVALUATION IN COMPARISON WITH MOLECULAR TESTS IN A PEDIATRIC UNIT

E-Posters

E-POSTER VIEWING

Alessandra Ferrari¹, Anna Vaccari^{1,2}, Denis Lombardo^{1,2}, Lorenza Bonetti¹, Elena Carboni¹, Mariano Simeone Cosentino¹, Gloria Fumagalli¹, Filippo Puricelli¹, Martina Soliani¹, Andrea Scaramuzza¹, Claudio Cavalli¹

¹ASST Cremona, Unit Of Pediatrics, Cremona, Italy, ²University of Brescia, School Of Pediatrics, Brescia, Italy

Backgrounds: Antigen tests can detect SARS-CoV-2 proteins from pharyngeal swabs and can be used as point-of-care procedure due to their availability and low cost. However, their sensitivity is lower than molecular tests, especially among asymptomatic individuals.

Methods: We analyzed a cohort of 103 subjects (81 pediatric patients and 22 caregivers), admitted to our Pediatric Emergency Unit, over a period of 3 months (from October 1 st to December 31st 2021). Antigen swabs were analyzed through the Sofia SARS Antigen Fluorescent Immunoassay (FIA) technology, while molecular swabs were centralized to the Microbiology Laboratory of our hospital. The Sofia SARS Antigen FIA uses advanced immunofluorescencebased lateral flow technology for qualitative detection of nucleocapsid protein from SARS-CoV-2. It provides results in 15 minutes with a self-contained test cassette. Both SARS-CoV-2 symptomatic patients within the first five days of disease and asymptomatic patients can be checked according to the constructor indications.

Results: In 100/103 subjects (97%) both antigen and molecular tests resulted negative for SARS-CoV-2 infection (true negative), 2/103 (2%) had both tests positive (true positive), 1/103 (1%) had negative antigen and positive molecular test (false negative), nobody had positive antigen and negative molecular test (false positive). In this cohort Sofia SARS Antigen FIA showed a sensitivity of 66.7%, specificity of 100%, accuracy of 99.03%, positive predictive value of 100% and negative predictive value of 99%.

Conclusions/Learning Points: In our setting Sofia SARS Antigen FIA provided reliable results based on a quick, safe and easily reproducible procedure. Thus, it could represent a useful tool to rapidly identify SARS-CoV-2 positive subjects soon after their approach to hospitals, to choose the safer pathway inside facilities. Anyway, the molecular tests remain the gold-standard to check patients inside the Units, when admitted.

EP345 / #1782

Topic: AS11. *Diagnostics and biomarkers*

STUDY ON QRT-PCR GENOTYPING TO DETECT NOROVIRUS INFECTION STATUS IN PEDIATRICS

E-Posters

E-POSTER VIEWING

Taojun He, Bin Li, Chao Wu

The eighth affiliated hospital of Sun Yat-sen University, Laboratory Medicine, shenzhen, China

Backgrounds: We adopted qRT-PCR typing testing Norovirus (NoV) infection in children, to study the correlation of viral loads and risk factors and prediction of NoV infectious gastroenteritis in children.

Methods:: According to the high conservation of norovirus open reading frames 1 and 2, GI / II-specific primers and probes were designed to efficiently NoV-GI and GII (IV was rarely detected). Clinical data and records of the first diagnosis were collected, and correlation statistical analysis was conducted to seek pathogenic risk factors and post-recovery judgment.

Results: The infection rate of pediatric NoV-GII was significantly higher than GI, and the Ct value of NoV-GII detected by qRT-PCR was significantly lower than GI, so the viral loads of GII was significantly higher than that of GI.

Conclusions/Learning Points: NoV-GII is the dominant strain of NoV gastroenteritis in pediatrics. The higher virus loads in the body, the more severe clinical symptoms in patients, also indicating the worse clinical outcomes.

EP346 / #1783

Topic: AS11. Diagnostics and biomarkers

STUDY ON QRT-PCR GENOTYPING TO DETECT NOROVIRUS INFECTION STATUS IN PEDIATRICS PATIENTS (UPDATE)

E-Posters

E-POSTER VIEWING

Taojun He, Bin Li, Chao Wu

The eighth affiliated hospital of Sun Yat-sen University, Laboratory Medicine, shenzhen, China

Backgrounds: Current data show that NoV is the main pathogen causing acute gastroenteritis in children. It usually occurs in children under 5 years old. We adopted qRT-PCR typing testing Norovirus (NoV) infection in 283 children, to study the correlation of viral loads and risk factors and prediction of NoV infectious gastroenteritis in children.

Methods:: According to the high conservation of norovirus open reading frames 1 and 2, GI/I associated specific primers and probes were designed to efficiently NoV-GI and GII (IV was rarely detected). Clinical data and records of the first diagnosis were collected, and correlation statistical analysis was conducted to seek pathogenic risk factors and post-recovery judgment.

Results: The infection rate of pediatric NoV-GII was significantly higher than GI, and the Ct value of NoV-GII detected by qRT-PCR was significantly lower than GI (means \pm SD 22.53 \pm 6.24 vs 25.65 \pm 5.04; OR=3.22, P=0.009), so the viral loads of GII was significantly higher than that of GI. Meanwhile the Ct value of different degree with clinical symptoms as mild, moderate and severe were 26.28 \pm 5.59 vs 21.66 \pm 4.02 vs 17.53 \pm 3.30, OR=5.09, P=0.003.

Conclusions/Learning Points: NoV-GII is the dominant strain of NoV gastroenteritis in pediatrics. The higher virus loads in the body, the more severe clinical symptoms in patients, also indicating the worse clinical outcomes.

EP347 / #1475

Topic: AS11. *Diagnostics and biomarkers*

THE ROLE OF BIOMARKERS IN DIAGNOSTIC APPROACHES IN NEONATES AND CHILDREN SUFFERING FROM VENTILATOR-ASSOCIATED PNEUMONIA (VAP)

E-Posters

E-POSTER VIEWING

George Koudounas¹, [Elias Iosifidis](#)¹, Maria Simitsopoulou¹, Emmanuel Roilides¹, Maria Sdougka²
¹Hippokration General Hospital, 3rd Department Of Pediatrics, Thessaloniki, Greece, ²Hippokration Hospital of Thessaloniki, Pediatric Intensive Care Unit, Thessaloniki, Greece

Backgrounds: Ventilator-associated pneumonia (VAP) is considered to be one of the most common nosocomial infections, especially among Pediatric and Neonatal ICU patients, and has been related to increased morbidity, length of stay and antibiotic usage. Nevertheless, the diagnostic approach of VAP remains debatable. The aim of this study is to evaluate the role of biomarkers in the diagnosis of VAP in critically ill children.

Methods: A systematic review of English language studies was conducted in order to investigate the diagnostic role of biomarkers in VAP. The electronic databases of Medline and EMBASE were searched until December 2021. The terms used to conduct the search included “biomarkers” and “VAP”. Data extraction and synthesis followed a standardized format on Covidence. All publication records were independently reviewed by two authors and disagreements were resolved by consensus. Inclusion criteria were: studies reporting data only for neonates and children for the diagnosis of VAP.

Results: Overall, 318 studies were found; among them, a total of 33 articles met inclusion criteria and were analyzed. Diagnostic modalities for VAP included CDC criteria and Clinical Pulmonary Infection Score (CPIS). New biomarkers for the diagnosis of VAP included mainly Soluble Triggering Receptor Expressed on Myeloid cells (S-TREM-1) and Surfactant protein D (SPD) in bronchoalveolar lavage (BAL). Increased concentrations of S-TREM-1 in BAL showed 96% sensitivity and 92% specificity in one of the included studies. Similarly, high SPD concentrations in BAL correlated well diagnosing suspected VAP among pediatric patients.

Conclusions/Learning Points: S-TREM-1 and SPD may play a vital role regarding diagnosis of suspected VAP in critically ill children. However, there is a great need for conducting large cohort studies in neonatal and pediatric patients to consolidate diagnostic utility of S-TREM-1 and SPD for VAP diagnosis.

EP348 / #1427

Topic: AS11. Diagnostics and biomarkers

MULTIPLE NODULAR LESIONS ON AN INFANT – A CHALLENGING DIAGNOSIS

E-Posters

E-POSTER VIEWING

Laura Leite De Almeida¹, Tomás Ferrão², Rita Alvelos², Luís Santiago³, Marisol Pinhal², Jorge Vaz Duarte²

¹Centro Hospitalar Universitário de São João, Pediatrics Department, Porto, Portugal, ²Centro Hospitalar de Baixo Vouga, Aveiro, Portugal, Pediatrics Department, Aveiro, Portugal, ³Centro Hospitalar de Baixo Vouga, Aveiro, Portugal, Dermatology Department, Aveiro, Portugal

Title of Case: MULTIPLE NODULAR LESIONS ON AN INFANT – A CHALLENGING DIAGNOSIS

Background: Scabies is a global public health concern. Its diagnosis is often challenging, especially during infancy, since it can have atypical appearances. Higher organism loads are present in this age, turning infants into very efficient vectors of transmission. Thus, early diagnosis and appropriate treatment play an important role.

Case Presentation Summary: A 6-weeks male infant presented to the emergency department with a 3-day history of a polymorphic skin eruption. No family members presented similar lesions. Skin examination revealed an erythematous base, with scattered vesicles, pustules, papules and nodules. The lesions were more prominent on the scalp and torso, including the neck, inguinal and axillary regions. Blood parameters including inflammatory markers were normal. However, due to the exuberance of the lesions, impetigo was considered and endovenous flucloxacillin was initiated. On the next day, the lesions worsened, and nodular scabies was suspected. Delta-wing-jet-sign on dermatoscopy confirmed this diagnosis. The patient and his parents were treated with 6% sulfur ointment during three consecutive days, repeated after seven days. At the follow-up-evaluation, four days after completing treatment, the infant presented more lesions on the back. During the previous days his aunt had been taking care of him, and neither her nor her family were treated. Therefore, the patient and all his close contacts, completed two new cycles of treatment, with complete resolution of the lesions.



Learning Points/Discussion: Nodular scabies is an uncommon manifestation of scabies infestation, more frequent in infants and in intertriginous areas, as seen in this case. Recognition of the different clinical patterns of scabies in different age groups is essential for an early diagnosis. Moreover, treatment of all close contacts and follow-up are important for a successful outcome.

EP349 / #1461

Topic: AS11. *Diagnostics and biomarkers*

SUPURATIVE CERVICAL LYMPHADENOPATHY WITH “7 LIVES”

E-Posters

E-POSTER VIEWING

Laura Leite De Almeida¹, Daniela Abreu², Mariana Bragança², Sofia Vasconcelos-Castro³, Ana Maia⁴
¹Centro Hospitalar Universitário de São João, Pediatrics Department, Porto, Portugal, ²Centro Hospitalar Universitário de São João, Immunoallergology Department, Porto, Portugal, ³Centro Hospitalar Universitário de São João, Pediatric Surgery Department, Porto, Portugal, ⁴Faculdade Medicina da Universidade do Porto, Gynecology-obstetrics And Pediatrics Department, Porto, Portugal

Title of Case: SUPURATIVE CERVICAL LYMPHADENOPATHY WITH “7 LIVES”

Background: Cat scratch disease (CSD) usually presents as a self-limiting lymphadenopathy. Its main cause is *Bartonella henselae*, a common pathogen of chronic cervical lymphadenitis in pediatric age. Wait-and-see is usually the preferred approach, however prolonged cases may need surgical intervention.

Case Presentation Summary: An 11-year-old female presented with a 1-year history of a painful right submandibular adenopathy. Serologic testing was positive for *Bartonella* species. Due to the development of inflammatory signs and fluctuation, incision and drainage was performed. During the following year, 5 episodes of suppuration occurred, and a chronic sinus tract was identified in echography. Needle-aspiration cytology was performed, but the biopsy was inconclusive. In a 2-year-period, she underwent a total of 7-antibiotic-cycles. Only the complete surgical excision of the lesion solved the symptoms. Histochemical analysis was compatible with CSD, and PCR assay positive for *Bartonella* spp.

Learning Points/Discussion: The lymphadenopathy in CSD is probably due to an immunological reaction, and antibiotic therapy is usually ineffective. Excisional drainage is not recommended due to the potential formation of sinus tract, as seen in this case. Complete excision is advocated in chronic cases, allowing a quick resolution of the symptoms.

EP350 / #431

Topic: AS11. *Diagnostics and biomarkers*

SEQUENCE TYPES DISTRIBUTION OF STRAINS OF STREPTOCOCCUS AGALACTIAE ISOLATED AT ALGIERS

E-Posters

E-POSTER VIEWING

Sadjia Mahrane¹, Guechi Zehor¹, Talimaamar Hassiba²

¹Chu hussein dey faculté of pharmacy, Pharmacie, Alger, Algeria, ²institut pasteur d'Algérie, Bactériology, Algiers, Algeria

Backgrounds: Purpose: to determine the serotypes and sequence types of Streptococcus agalactiae strains isolated from invasive neonatal infections

Methods: Material and methods A collection of strains of Streptococcus agalactiae isolated from invasive neonatal infections from cerebrospinal fluid and blood cultures (20 strains of CSF and 13 strains of blood culture) For these strains, a determination of the serotypes by multiplex PCR according to the Monica Impéri protocol was carried out followed by an MLST according to the protocol described by Jones (2003) for the determination of ST. The data obtained were submitted to the PUBMLST database

Results: Results Of the 33 strains selected, 20 strains are serotype III, 5 are serotype Ia, and 5 strains are serotype V, and two strains are serotype IV and serotype Ib When to distribute strains according to ST: 9 are ST 17, 8 are ST 19, 3 ST 1 and 3 ST 10, 3 ST196, 2 strains ST4, and one strain of each ST ST 23, ST26, ST870, ST278 and ST 237 8/20 meningeal strains of streptococcus group B belong to ST 17 and are all serotypes III and 6 of them are isolated during late syndrome 6/20 of the isolates belong to ST 19 and all of serotype III and 4 of them are responsible for late syndrome

Conclusions/Learning Points: Conclusion: The invasive strains of Streptococcus agalactiae are predominantly serotype III and belong to the two major STs: ST17 and ST19

EP351 / #1468

Topic: AS11. Diagnostics and biomarkers

HYPOPHOSPHATEMIA IN DIFFERENT FEBRILE SYNDROMES AND ITS CLINICAL SIGNIFICANCE

E-Posters

E-POSTER VIEWING

Yonatan Milman¹, Liat Ashkenazi-Hoffnung^{2,3}, Daniel Landau^{3,4}, Asaf Lebel⁵

¹Schneider Children's Medical Center of Israel, Pediatrics B, Petah Tikva, Israel, ²Schneider Children's Medical Center, Departement Of Day Hospitalization, Petah Tikva, Israel, ³Tel Aviv University, Sackler Faculty Of Medicine, Tel Aviv, Israel, ⁴Schneider Children's Medical Center, Nephrology Institute, Petah Tikva, Israel, ⁵Emek Medical Center, Pediatric Nephrology Unit, Afula, Israel

Backgrounds: Background: Phosphorus is a key element in cell function and energy storage and its levels may be regulated by inflammatory signals. The extent of hypophosphatemia in different febrile syndromes and its clinical significance have not yet been elucidated.

Methods: Data were retrospectively collected for febrile children aged 3 months-18 years hospitalized at the pediatric wards of a tertiary care hospital, during 2010-2019, using an automated search in computerized medical records. A comparison of phosphorus levels between bacterial infection (BI), viral infection (VI) and Kawasaki disease (KD) was carried-out. Univariate and multivariate analyses for factors associated with severe disease course were performed.

Results: The cohort included 3963 febrile children, of whom 559 had a BI, 3271 a VI and 133 had KD. Patients with a BI had higher rates of hypophosphatemia (49.2% versus 19.7% in VI and 31.6% in KD, $P < 0.001$) and hypophosphatemia was more severe (median phosphate standard deviation score [P-SDS]: -1.85 Interquartile range [IQR] 2.08 versus -0.56 IQR 2.08 and -1.20 IQR 2.28, in BI, VI and KD, respectively). A P-SDS of -2.00 had 80.3% sensitivity and 47.8% specificity for the diagnosis of a BI. Univariate and multivariate analyses showed that hypophosphatemia was associated with a more severe disease course, manifested by longer hospital stay (+2.10 days, 95%CI: 0.75-3.46, $p = 0.003$), higher rate of ICU admission (OR 2.63, 95%CI: 1.94-3.56, $p < 0.001$), and a trend towards higher rate of death (0.3% versus 0.03%, $p = 0.07$).

Conclusions/Learning Points: Conclusion: Hypophosphatemia is more common among hospitalized children with a BI compared to VI and KD and is associated with a more severe disease course.

Topic: AS11. Diagnostics and biomarkers

GASTROINTESTINAL PANEL PERFORMANCE FOR THE DIAGNOSIS OF ACUTE GASTROENTERITIS IN PEDIATRIC PATIENTS

E-Posters

E-POSTER VIEWING

Marwa Mohamed Ali¹, Abdulrahman Masood¹, Lateefa Almutawea¹, Gabriel Fox¹, Imelda Lambert¹, Amira Ahmed², Maryam Abdulsamad²

¹King Hamad University Hospital, Pediatrics, Muharraq, Bahrain, ²King Hamad University Hospital, Microbiology, Muharraq, Bahrain

Backgrounds: A variety of methods are used for identification of acute gastroenteritis (AGE) causative organisms. Gastrointestinal panel (GI-P) has the potential to detect up to 22 pathogens rapidly. We focused on the clinical impact of GI-P on the pediatric population

Methods: A Retrospective study conducting GI-Ps and clinical details of inpatient pediatric patients presenting with AGE in a tertiary hospital over one year.

Results: 220 GI-P samples were collected. 154 (70%) samples were positive with at least one organism being mostly detected in toddlers. 35% (78) had single organism while 5% (11) detected 4 or more organisms. The most common bacteria was Enteropathogenic E.coli with peak detection in July and September. Norovirus was detected in 21% followed by Rota virus. Viruses were as well detected mostly in July. Parasites were detected in 7 specimens. GI-P and stool culture were done in 134 sample and were positive with the same organism in 18 specimens versus 3 with a different organism than in stool culture. 96 samples had positive GI-P but negative stool culture, 72 samples had positive GI-P but negative both stool analysis and culture while 40 were clinically sick patients presenting with picture of AGE.

■ Infant 1m-1y ■ Toddler 1-3y ■ Pre-school 3-6 ■ School age 6-12 ■ Adolescent >12

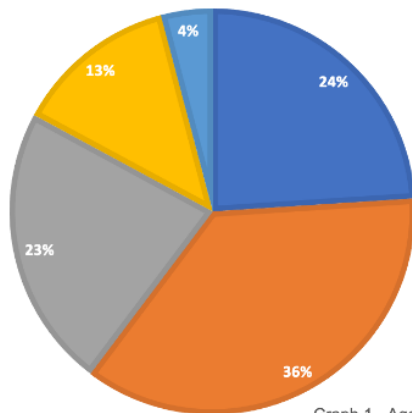

Graph.1 - Age distribution of the positive GI-P

Conclusions/Learning Points: GI-P is valuable tool in detecting the causative pathogen of AGE in children specially if clinically sick; although it can detect multiple organisms which might indicate a carrier status. The most commonly detected bacteria was Enteropathogenic E.coli. while Norovirus was the most common virus detected

Topic: AS11. *Diagnostics and biomarkers*

PEDIATRIC OSTEOARTICULAR INFECTIONS: ARE WE MISSING OPPORTUNITIES TO OBTAIN A MICROBIOLOGICAL DIAGNOSIS?

E-Posters

E-POSTER VIEWING

Belen Moreno Pavon^{1,2}, Laura Calle-Miguel³, María Fernández Miaja³, Elisa García-García⁴, Alejandra Méndez Sánchez⁵, Carlos Pérez Méndez⁵, Luis Vega López³, Virginia Courel Del Río³, Sheila Martín Pino³, Ana Morilla Morilla⁶

¹CENTRO DE SALUD CONTRUECES, Pediatrics, Gijon, Spain, ²CS CONTRUECES, Pediatrics, Gijon, Spain, ³HOSPITAL UNIVERSITARIO CENTRAL DE ASTURIAS, Pediatrics, Oviedo, Spain, ⁴CS LAVIADA, Pediatrics, Gijón, Spain, ⁵Hospital Universitario de Cabueñes, Pediatrics, Gijón, Spain, ⁶HOSPITAL UNIVERSITARIO CENTRAL DE ASTURIAS, Microbiology, OVIEDO, Spain

Backgrounds: Microbiological tools for management of osteoarticular infections (OAI) have improved over the last decade. This study aims to investigate the impact of Nuclear-Acid-Amplification Tests (NAATs) in the etiological diagnosis.

Methods: A retrospective study of patients up to 14 years old admitted with an OAI in two main hospitals of Asturias (Northern Spain) between 2014 and 2021 was performed. Laboratory data were retrospectively collected from medical electronic records and a descriptive and comparative analysis were performed between periods (2014-2017 vs 2018-2021) and hospitals.

Results: Sixty-three children were identified [61.9% males; median age 7.5 years old (IQR 2.5-10.9)], corresponding to 33 osteomyelitis, 27 septic arthritis and 3 osteoarthritis. A pathogen was detected in 52.4% of the patients, being *Staphylococcus aureus* (n=20), *Streptococcus pyogenes* (n=4) and *Kingella Kingae* (n=3) the most common. Detection in tissue samples (either bone biopsy, joint fluid or drainage sample) was 22/33 and in blood 19/33. Differences in detection rates by conventional culture and NAATs between periods and hospitals are summarized in the table.

| | Total | 2014-2017 | 2018-2021 | P-value | Hospital 1 | Hospital 2 | P-value |
|---|------------------|------------------|------------------|---------|------------------|-----------------|---------|
| Microbiological confirmation | 33/63 (52.4%) | 14/26 (53.8%) | 19/37 (51.4%) | 0.845 | 24/40 (60%) | 9/23 (39.1%) | 0.110 |
| Confirmation by conventional culture | 26/33 (78.8%) | 11/14 (78.6%) | 15/19 (78.9%) | >0.999 | 17/24 (70.8%) | 9/9 (100%) | 0.149 |
| Confirmation by NAATs | 10/33 (30.3%) | 7/14 (28.6%) | 6/19 (31.6%) | >0.999 | 10/24 (29.2%) | 0/9 (0%) | 0.032 |
| Missed opportunities of microbiological diagnosis | 7/30 (23.3%) | 5/12 (41.7%) | 2/18 (11.1%) | 0.084 | 7/16 (43.8%) | 0/14 (0%) | 0.007 |

Conclusions/Learning Points: We found no major improvement in the detection of pathogens along the period. NAATs are often underused and opportunities to achieve microbiological confirmation are often missed.

EP354 / #333

Topic: AS11. Diagnostics and biomarkers

C-REACTIVE PROTEIN, AS A CLINICAL MARKER OF LYME BORRELIOSIS IN CHILDREN

E-Posters

E-POSTER VIEWING

Svitlana Nykytyuk^{1,2}, Sofia Levenets², Sergiy Klymnyuk³

¹I.Horbachevsky National Medical University, Department Of Pediatric With Child Surgery, Ternopil, Ukraine, ²I.Horbachevsky National Medical University, Pediatric Department With General Surgery, Ternopil, Ukraine, ³I.Horbachevsky National Medical University, Immunology And Microbiology, Ternopil, Ukraine

Backgrounds: Lyme borreliosis (LB) is an endemic multisystemic disease caused by the *Borrelia burgdorferi sensu lato* spirochete (sl). As children are the most dynamic group of society, they are in the highest risk group of tick bite and therefore, of Lyme borreliosis. Clinically manifested by erythema migrans, arthritis, neurolyme, which may be accompanied by signs of general malaise, chills, fever.

Methods: Serum from patients with Lyme disease was used as a material. Serum CRP levels were measured by enzyme-linked immunosorbent assay, and immunological changes associated with acute Lyme disease and isolated sequelae of *B. burgdorferi* infection were assessed. The study was performed by evaluating clinical data, cytokine analysis. The results were sorted by statistical analysis according to similarity.

Results: In the study of blood in children increasing level of C-reactive protein was found. Circulating CRP levels as well as concentrations > 3 mg/ml were found to be significantly higher in the post-treatment Lyme syndrome group than in the control group of subjects with a history of Lyme disease but no persistent symptoms. Interleukin-1 β and markers of acute inflammation were found to be elevated in acute Lyme disease, so it can be assumed that CRP levels correlate with Interleukin-1 β

Conclusions/Learning Points: *B. burgdorferi* infection stimulates the coordinated production of CRP and Interleukin-1 β (IL-1 β), which increase in the acute phase.

Topic: AS11. Diagnostics and biomarkers

THE PERFORMANCE OF THE BV SCORE FOR DIFFERENTIATING BETWEEN BACTERIAL AND VIRAL INFECTION IS ROBUST TO METHODOLOGICAL ALTERNATIVES IN BUILDING THE REFERENCE STANDARD

E-Posters

E-POSTER VIEWING

Cihan Papan¹, Alberto Argentiero², Susanna Esposito³, Tobias Tenenbaum⁴

¹Saarland University, Centre For Infectious Diseases, Institute Of Medical Microbiology And Hygiene, Homburg, Germany, ²Università degli Studi di Perugia, Santa Maria Della Misericordia Hospital, Perugia, Italy, ³University of Parma, Pietro Barilla Children’s Hospital, Parma, Italy, ⁴Academic Teaching Hospital Charité-Universitätsmedizin, Sana Klinikum Lichtenberg, Berlin, Germany

Backgrounds: A host-protein score (BV score) based on TNF-related apoptosis-induced ligand (TRAIL), interferon gamma-induced protein-10 (IP-10), and C-reactive protein (CRP) was shown to accurately differentiate bacterial from viral infections. We assessed the impact of reference standard methodology on performance results.

Methods: Sub-analysis of children selected randomly from AutoPilot-Dx study. Five reference standards were generated based on two separate adjudication processes, where independent clinical experts were provided with comprehensive patient data (except BV score). Adjudicators were either ‘blinded’ or ‘unblinded’ to CRP and procalcitonin. The reference standards were built as follows: (1) Majority unblinded – ≥2/3 experts assigning same classification (bacterial or viral) with confidence >90% or all with confidence ≥70%; (2) Unanimous unblinded – all experts assigning same classification with confidence >90%; (3) Majority blinded – (1) with blinded experts; (4) Unanimous blinded – (2) with blinded experts; (5) All inclusive – indeterminate cases from majority blinded cohort were subjected to additional adjudications until majority attained. BV score performance was compared to each reference standard.

Results: There were no changes of viral to bacterial reference standard outcomes or vice versa comparing blinded vs. non-blinded. Performance was comparable across the 5 reference standards (Table). Table: Performance across different cohorts

| | All-inclusive blinded | Majority blinded | Unanimous blinded | Majority unblinded | Unanimous unblinded |
|-----------------------------|-----------------------|-------------------|---------------------|---------------------|---------------------|
| n | 270 | 224 | 125 | 231 | 137 |
| Sensitivity % | 90.0 (78.6-100.0) | 93.3 (79.0-100.0) | 100.0 (100.0-100.0) | 100.0 (100.0-100.0) | 100.0 (100.0-100.0) |
| Specificity % | 82.2 (77.1-87.4) | 85.8 (80.8-90.8) | 91.9 (86.7-97.0) | 88.0 (83.4-92.7) | 94.9 (90.9-98.9) |
| Positive predictive value % | 41.5 (29.2-53.8) | 34.1 (19.0-49.3) | 40.0 (11.9-68.1) | 46.5 (31.0-62.0) | 57.1 (27.5-86.8) |
| Negative predictive value % | 98.3 (91.6-100.0) | 99.4 (93.2-100.0) | 100.0 (94.1-100.0) | 100.0 (94.4-100.0) | 100.0 (95.6-100.0) |
| Equivocal % | 9.6 | 8.5 | 6.4 | 8.2 | 8.0 |

Conclusions/Learning Points: BV score performance is robust to alternative reference standards.

EP356 / #1440

Topic: AS11. *Diagnostics and biomarkers*

WHOLE TRANSCRIPTOMIC OF TWO DIFFERENT PLACENTAL CELL LINES INFECTED WITH ZIKA VIRUS: A PILOT STUDY

E-Posters

E-POSTER VIEWING

Alberto Gómez Carballa¹, Eva Mazzetto², Irene Rivero-Calle^{1,3}, Jacobo Pardo-Seco³, Francesco Bonfante², Federico Martínón-Torres³, Antonio Salas¹

¹University of Santiago de Compostela, Genetics, Vaccines And Paediatrics Research Group, Santiago de Compostela, Spain, ²Istituto Zooprofilattico Sperimentale delle Venezie, 5division Of Comparative Biomedical Sciences, Venice, Italy, ³Hospital Clínico Universitario de Santiago de Compostela, Translational Paediatrics And Infectious Diseases, Paediatrics Department, Santiago de Compostela, Spain

Backgrounds: Molecular mechanisms underlying trans-placental zika virus infection is one of the most challenging questions concerning the zika virus congenital disease. Although it is well known that other flaviviruses can infect the fetus crossing the mother's placenta, none have the impact of zika maternal-fetal infection.

Methods: We carried out an in vitro zika infection assay to understand the zika pathogenesis during the last stages of pregnancy without the potential interference of the host variability. We have considered two immortalized placental cell lines representative of a full-term placental barrier: the invasive trophoblasts from the maternal decidua (HTR-8), and the cytotrophoblast from the placental villi (BeWo). Both cell lines were infected with the Asian lineage of zika (12 replicates: 6 mock/6 infected) and removed at 24h and 72h post-infection. Following RNA isolation, we carried out a whole transcriptome sequencing analysis (RNA-seq) of the samples.

Results: We found different transcriptomic patterns in villous and extra-villous cells at 24h post-infection. Trophoblast cells showed an up-regulation of rRNA related processes, while cytotrophoblast showed an early antiviral response driven by the activation of IFN and JAK-STAT pathways. Over-expression of genes involved in viral defense pathways showed up-regulation in both cell lines at 72h post-infection. A set of 15 over-expressed genes represented the common antiviral response to the infection in both cell lines at 72h post-infection, including interferon lambda genes and interferon induced genes (e.g. OAS, IFIT and IFIH1), as well as chemokines CCL5 and CXCL10.

Conclusions/Learning Points: Our results highlighted different immune responses from placental cells to zika infection.

EP357 / #946

Topic: AS11. Diagnostics and biomarkers

HIGH CONCENTRATIONS OF PROTEIN OXIDATION BIOMARKER O-TYROSINE/PHENYLALANINE PREDICTS BETTER OUTCOME IN CHILDHOOD BACTERIAL MENINGITIS

E-Posters

E-POSTER VIEWING

Emilie Rugemalira¹, Irmeli Roine², Julia Kuligowski³, Ángel Sánchez-Illana³, José Pineiro-Ramos³, Sture Andersson¹, Heikki Peltola¹, Manuel Cruzeiro⁴, Tuula Pelkonen¹, Máximo Vento³

¹Helsinki University Hospital, Children's Hospital, Pediatric Research Center, Helsinki, Finland, ²University Diego Portales, Faculty Of Medicine, Santiago, Chile, ³Health Research Institute La Fe, Neonatal Research Group, Valencia, Spain, ⁴Hospital Pediátrico David Bernardino, Neuropediatric Department, Luanda, Angola

Backgrounds: Neuronal damage in bacterial meningitis (BM) is due bacterial toxin release and the host's inflammatory response where oxidative stress plays a major pathophysiological role. We aim to study the association of cerebrospinal fluid (CSF) biomarkers, indicative of oxidative damage to proteins, with outcome in childhood BM.

Methods: The biomarker concentrations of ortho-tyrosine/phenylalanine (o-Tyr/Phe), 3-chlorotyrosine/para-tyrosine (3Cl-Tyr/p-Tyr) and 3-nitrotyrosine/para-tyrosine (3NO₂-Tyr/p-Tyr) were measured from 79 BM admission CSF samples employing liquid chromatography coupled to tandem mass spectrometry (LC-MS/MS). Besides death, disease outcomes (neurological sequelae, ataxia, hearing impairment) were registered on day seven of treatment, at discharge and one month after discharge. The outcome was graded according to the modified Glasgow outcome scale (GOS) that considers neurological and audiological sequelae with grading from 1 (death) to 5 (mild/no disability).

Results: The children whose o-Tyr/Phe was below median presented an OR of 2.85 (95%CI 1.14-7.14) and 5.23 (95%CI 1.66-16.52) of having suboptimal GOS (<5) on day seven of treatment and one month after discharge, respectively, compared to those whose o-Tyr/Phe was above median. Additionally, these children presented an OR of 8.55 (95%CI 2.27-32.22) and 3.99 (95%CI 1.23-12.73) of having any neurological sequelae on day seven of treatment or at discharge, respectively and an OR of 8.55 (95%CI 2.27-32.22), 4.9 (95%CI 1.45-16.55) and 5.83 (1.12-30.4) of having ataxia on day seven of treatment, at discharge or one month after discharge, respectively. The other biomarker ratios measured did not show significant association with outcome.

Conclusions/Learning Points: We suggest that a higher CSF o-Tyr/Phe ratio predicts better outcome in paediatric BM with less neurological sequelae, ataxia, and a favourable GOS. This finding could offer new therapy approaches in research aiming in influencing the inflammation in BM.

EP359 / #1337

Topic: AS11. Diagnostics and biomarkers

HIGHLY SENSITIVE MOLECULAR DETECTION OF MALARIA PARASITE WITHIN 30-MINUTES: PEAKPCR AS A POINT-OF-CARE SOLUTION

E-Posters

E-POSTER VIEWING

Philippe Bechtold^{1,2}, Philipp Wagner^{3,4}, Salome Hosch^{3,4}, Ombretta Pasotti^{5,6}, Christophe Ndoua⁷, Regina Lenguetama⁸, Jean Gody⁹, Wendelin Stark^{1,2}, Claudia Daubenberger^{3,4}, Tobias Schindler^{3,4}, [Ulrich Vickos](#)^{10,11}

¹Institute for Chemical and Bioengineering, Eth Zurich, Zurich, Switzerland, ²Diaxxo AG., Chemical And Bioengineering, Zurich, Switzerland, ³Swiss Tropical and Public Health Institute, Clinical Immunology, Basel, Switzerland, ⁴University of Basel, Biology Immunology, Basel, Switzerland, ⁵Ospedale Pediatrico Bambino Gesù, Health Management, Rome, Italy, ⁶Saint Joseph Moscati, Health Management, Yamoussoukro, Côte d'Ivoire, ⁷Ministry of health, National Program Malaria Control, Bangui, Central African Republic, ⁸Ministry of health, National Centre Of Blood Transfusion, Bangui, Central African Republic, ⁹Pediatric Hospital and University Complex, Intensive Care Unit, Bangui, Central African Republic, ¹⁰Amitié Hospital, Bangui, Infectious And Tropical Diseases Unit-medicine Department, Bangui, Central African Republic, ¹¹Ospedale Pediatrico Bambino Gesù, Clinical Immunology And Vaccinology, Rome, Italy

Backgrounds: Despite tremendous success in reducing malaria burden, more than 400'000 deaths are recorded yearly. Malaria diagnosis in endemic countries depends heavily on rapid diagnostic tests (RDTs) detecting parasite-derived antigens in blood. The RDTs limited sensitivity, when applied to asymptomatic parasite carriers, makes them less suitable for malaria control/surveillance activities. For continuous malaria monitoring programs, highly sensitive, and scalable diagnostic approaches are required. PeakPCR is a low-cost, portable, and easy-to-use next generation nucleic acid amplification technique (NAAT) platform with minimal hands-on-operations required and lyophilized reagents preloaded cartridges for the reactions. We investigated peakPCR for its use as a malaria rapid and sensitive diagnostic tool.

Methods: During March 2021, dried-blood-spots (DBS) of febrile children, aged 5 months to 15 years admitted at the Paediatric Hospital of Bangui, were collected. For the peakPCR-Malaria rapid NAAT clinical evaluation, we selected 31 *P. falciparum* positive children, stratified by parasite density in low (median: 586 parasites/uL) and high (median: 25'800 parasites/uL) infection intensity, and 16 negative children, all without *pfhrp2/3* gene deletions. Thick blood smear microscopy, RDTs and RT-qPCR analysis were used for comparative analysis.

Results: The peakPCR-Malaria rapid NAAT detected all 15 high intensity infection group children and 14/16 from the low intensity infection group, resulting in sensitivities of 100% and 87.5%, respectively. All 16 negative patients were identified correctly. A Cq values high correlation between the peakPCR-Malaria rapid NAAT and the standard 18S rDNA/rRNA-based RT-qPCR assay on the Bio-Rad CFX96 was observed.

Conclusions/Learning Points: Our novel molecular diagnostic approach for *Plasmodium falciparum* can be run on the portable peakPCR device in 30 minutes resulting in high-quality malaria diagnosis comparable with current RT-qPCR techniques. The peakPCR-Malaria rapid NAAT brings sensitive malaria testing one step closer to peripheral health infrastructures.

EP360 / #1589

Topic: AS11. *Diagnostics and biomarkers*

PRESEPSIN AS A PROGNOSTIC MARKER OF NEONATAL SEPSIS

E-Posters

E-POSTER VIEWING

Olena Vlasova, Larysa Koliubakina

Bukovinian State Medical University, Department Of Pediatrics And Pediatric Infectious Diseases, Chernivtsi, Ukraine

Title of Case: PRESEPSIN AS A PROGNOSTIC MARKER OF NEONATAL SEPSIS

Background: Presepsin (PSP) - protein, concentration which in the blood increases rapidly due to the development of infectious-inflammatory process, in particular sepsis

Case Presentation Summary: The child F., a girl, was born from the 5th pregnancy, which took place against the background of chronic pyelonephritis, vulvovaginitis, extragenital pathology. Childbirth II in 24-25 weeks pregnancy by caesarean section with uterine bleeding, leg presentation. Apgar score in the first minute 2 points, for 5 minutes - mechanical ventilation. During the stay in the maternity hospital the child's condition remained severe, without positive dynamics due to severe combined pathology: severe asphyxia in childbirth, respiratory distress syndrome on the background of intrauterine infection complicated by multiorgan insufficiency. A comprehensive clinical and paraclinical examination was performed: the level hemoglobin was 140 G / l, leukocytosis - 36.4 G / l, platelets - 160 G / l. In the dynamics of the second and the third day of life the level of C-reactive protein (CRP) was 60 mg / l. On the third day of life there was a decrease in platelet count to 116 G / l and an increase in leukocytosis to 42.0 G / l. For intensive care and observation, the child was transferred to the hospital. While conducted constant clinical and paraclinical monitoring. The level of CRP did not exceed 6 mg / l, presepsin – 11000 pg / ml. At the stage of hospital the diagnosis was formed: Neonatal sepsis. Despite the treatment, this case ended unfavorably at the age of 1 month.

Learning Points/Discussion: Determination of presepsin in serum is an effective marker of verification of neonatal sepsis, but requires further study in premature infants

EP361 / #1308

Topic: AS12. Health associated infections, infection prevention and control

THE EPIDEMIOLOGY OF HOSPITALIZATION FOR PEDIATRIC OSTEOMYELITIS IN BRAZIL

E-Posters

E-POSTER VIEWING

Caio Augusto De Lima¹, Nathalia Caroline Teixeira Zana¹, Veronica Perius De Brito¹, Alessandra Akemi Cury Satokata¹, Marcos Vinicius Teixeira Martins¹, João Victor Aguiar Moreira¹, Douglas Alves Da Costa Canella², Artur Rodrigues Mazurek², Mariângela De Lima Alves¹, Claudia Aparecida Botelho Carrijo¹, Otavio Augusto Freire Campos¹, Sebastiana Silva Sabino¹, Andressa Pereira Ribeiro¹, Monike Evelyn Da Silva¹, Victor Pereira Do Couto Muniz¹, Fernanda Souza Alves¹, Alice Mirane Malta Carrijo¹, Guilherme Vendramini Vasconcelos¹, Gustavo De Souza Henriques³, Tatiany Calegari¹
¹Federal University of Uberlândia, Faculty Of Medicine, Uberlandia, Brazil, ²Federal University of Grande Dourados, Faculty Of Medicine, Grande Dourados, Brazil, ³Escola Superior de Ciências da Santa Casa de Misericórdia de Vitória (EMESCAM), Faculty Of Medicine, Vitória, Brazil

Backgrounds: Osteomyelitis is an invasive disease that is still an important cause of childhood morbidity. Its early diagnosis is essential to prevent complications and occurs through clinical-epidemiological approaches.

Methods: Epidemiological study with data registered in the Sistema de Informações de Morbidade Hospitalar of the Ministry of Health of Brazil, from 2011 to 2020. Measures of central tendency and confidence intervals were estimated for the variables, as well as hypothesis tests for their temporal behaviors, with a significance of 5%.

Results: An annual average of 1502.90 (± 245.99) hospitalizations was recorded, with a downward trend (p -value=0.0231) and a mortality rate of 0.18% (± 0.06). By sex, there is a predominance of males with 68.79% (± 4.22) of hospitalizations. A mortality rate of 0.25% (± 0.07) was observed for the female population, 3.57 times larger than the male. By age group, there was a predominance of individuals between 10 and 14 years old, with 46.75% (± 4.15) of the total number of hospitalizations. Mortality was higher in children under one year of age, 1.18% (± 0.23), with a tendency to decrease with increasing age (p -value=0.0014). By ethnicity, the predominance was of the brown population with 55.78% (± 3.12) of the total. For caucasian and black, there are, respectively, 39.55% (± 1.29) and 2.83% (± 0.30).

Conclusions/Learning Points: Osteomyelitis is an important cause of pediatric hospitalizations in the Brazilian health system. The data presented here seem to indicate an improvement in the effectiveness of management programs for this disease. However, the discrepancies observed point to the importance of developing new strategies, focused mainly on diagnosis, for the brown male population, between 10 and 14 years old, and on treatment for the female group, under one year old, aiming to reduce national indices.

Topic: AS12. Health associated infections, infection prevention and control

BACTEREMIAS IN PEDIATRIC-ONCOLOGY PATIENTS OF A GREEK UNIVERSITY HOSPITAL: OUR EXPERIENCE OVER A 5-YEAR PERIOD OF TIME.

E-Posters

E-POSTER VIEWING

Athanasios Bangeas¹, Efthymia Protonotariou², Maria Palampougiouki¹, Maria Ioannidou¹, Emmanuel Hatzipantelis¹, LEMONIA Skoura², Tania Siahaidou³, Maria Tsolia⁴, Athanasios Tragiannidis¹
¹Medical School, Faculty of Health Sciences, Aristotle University of Thessaloniki, AHEPA University Hospital, Pediatric & Adolescent Hematology-oncology Unit, 2nd Department Of Pediatrics, THESSALONIKI, Greece, ²Medical School, Faculty of Health Sciences, Aristotle University of Thessaloniki, AHEPA University Hospital, Department Of Microbiology, THESSALONIKI, Greece, ³School of Medicine, National and Kapodistrian University of Athens, 1st Department Of Pediatrics, ATHENS, Greece, ⁴National and Kapodistrian University of Athens, Aglaia Kyriakou Children's Hospital, 2nd Department Of Pediatrics, ATHENS, Greece

Backgrounds: Bacteremias are a major cause of morbidity and mortality in pediatric-oncology patients, who face an increased risk of these infections. The aim of this study was to determine the epidemiology of bacteremias, regarding the species distribution, the most common risk factors and the main outcomes.

Methods: A retrospective analysis was conducted including all positive blood cultures from pediatric-oncology patients, from 1 to 16 years old, who were treated in the Hematology-Oncology Pediatric Unit of AHEPA University Hospital of Thessaloniki between January 2014 and December 2018. Data were collected from patients' printed and electronic medical records.

Results: We identified 73 episodes of bacteremias (56.2% male; median 6 years 5 months; 13.7% solid tumors, 72.6% ALL, 13.7% AML; 95.8% with indwelling permanent catheter). Regarding risk factors, the isolation of a Gram-positive or Gram-negative bacteria was associated with WBC count and severe neutropenia ($p < 0.05$ respectively). Gram-positive bacteria were isolated in 49.3% of the episodes and Gram-negative in 50.7%. Coagulase-neg. staphylococci were most frequent (39.7%), followed by E.coli (17.8%) and Klebsiella pneumoniae (17.8%). 13.5% Carbapenemase-producers and 8.1% ESBL-producers were found regarding Gram-negative isolates. In relation to Gram-positive, 63.8% were identified as MR-CoNS with a significant increase in the last 2 years. 11% of catheters were removed, 2.73% of episodes resulted in ICU transfer and the 3-month mortality rate was 11%.

Conclusions/Learning Points: Our results demonstrate an almost equal distribution of Gram-positive and Gram-negative bacteremias in total but with an increase in the isolation of Gram-positive bacteria over the last 3 years of the study, which is consistent with worldwide experience of bloodstream infections in pediatric oncology. This rise in the isolation of Gram-positive bacteria coincides with the emergence of Methicillin-resistant strains.

EP363 / #1331

Topic: AS12. Health associated infections, infection prevention and control

DIFFICULTY IN THE CLINICAL DIAGNOSIS OF TULAREMIA: A CASE REPORT

E-Posters

E-POSTER VIEWING

Alessandra Iacono¹, Ilaria Bianchedi², Sara Dal Bo¹, Caterina Radice¹, Lorenzo Iughetti², Federico Marchetti¹

¹Santa Maria delle Croci Hospital, Department Of Pediatrics, Ravenna, Italy, ²Post-graduate School of Pediatrics, Department Of Medical And Surgical Sciences Of The Mother, Children And Adults. University Of Modena And Reggio Emilia, Modena, Italy

Title of Case: Difficulty in the Clinical Diagnosis of Tularemia: a case report

Background: Tularemia is an acute febrile zoonotic illness caused by the highly infectious Gram-negative organism, *Francisella tularensis*, with low incidence in Italy. Lagomorphs and small rodents are key hosts. We describe a case of pediatric tularemia presented with high fever and skin manifestation.

Case Presentation Summary: An 8-year-old girl presented with a 4-day history of high fever, diffuse skin manifestation (widespread pustule-crusty lesions), aphthous stomatitis, conjunctival hyperaemia, submandibular lymphadenopathy and a small vaginal ulcerated lesion. Two days before the onset of the fever she had been bitten in the forehead by a mosquito with the formation of an erythematous papule. She lived in the countryside and owned several animals (including hares). Her blood count revealed lymphopenia (L 920/mm³) and an increased value of CRP at 29.4 mg/L. An empirical therapy with Cefotaxime and Clindamycin was started and after 48 hours she was afebrile. After 7 days new diffuse papular lesions appeared and the old ones became dark eschars. The main serologies were excluded (EBV, HSV 1/2, HHV 6-7-8, VZV, Mycoplasma, Chlamydia pneumoniae, Rickettsiosis, Leishmaniasis); serology for *F. tularensis* (IgG plus IgM) was positive. The therapy was replaced with Ciprofloxacin and Gentamicin with a stable clinical improvement.

Learning Points/Discussion: The wide spectrum of clinical presentation of tularemia constitutes a major challenge for clinicians. Early diagnosis and the prompt administration of appropriate antimicrobial therapy (aminoglycoside) are crucial for successful disease management. We suggest clinicians should consider tularemia as a possible diagnosis, especially in people who live in the countryside, even if there is neither a classic presentation nor a high incidence reported. A high index of suspicion is especially required for rarer entities presenting with rather common symptoms.

EP364 / #1379

Topic: AS12. Health associated infections, infection prevention and control

COGNITIVE PERFORMANCE IN SCHOOL CHILDREN WITH AND WITHOUT FACE MASKS

E-Posters

E-POSTER VIEWING

Anne Schlegtendal¹, Lynn Eitner¹, Thomas Lücke², Kathrin Sinnigen², Folke Brinkmann¹
¹University Children's Hospital, Paediatric Pneumology, Bochum, Germany, ²University Children's Hospital, Neuropaediatrics, Bochum, Germany

Backgrounds: Wearing a face mask at school has become mandatory during the last two years. Concerns regarding cognitive performance of pupils when wearing a mask at school were raised. We established a real life scenario at school evaluation the ability to concentrate in students with and without a face mask.

Methods: Students from grade 5-7 were randomized into two groups. One was wearing a face mask during 4 school lessons followed by an online cognitive test still wearing the mask, the other has lessons without a face mask and then took the same validated online test on cognition and concentration ability without a mask.

Results: 120 students were randomized into two age and sex matched groups. Both groups showed similar performance in all subtests.

Conclusions/Learning Points: Wearing face masks at school does not influence cognition and concentration ability in students and therefore be recommended for infection control measures.

EP365 / #414

Topic: AS12. Health associated infections, infection prevention and control

CENTRAL LINE SIZE ASSOCIATED WITH INFECTIONS IN PAEDIATRIC PATIENTS

E-Posters

E-POSTER VIEWING

Bryan Chng¹, Ashwin Venkatakrishnan², Chelsea Stubbs²

¹Imperial College London, Imperial College School Of Medicine, London, United Kingdom, ²Imperial College London, School Of Medicine, London, United Kingdom

Backgrounds: Central venous catheters (CVCs) are devices inserted for long-term vascular access, allowing provision of parenteral nutrition, intravenous administration of medication and other materials. However, CVCs are associated with development of Central Line-Associated Bloodstream Infections (CLABSIs), a significant cause of morbidity in the paediatric population, which is a demographic covered less extensively in current literature. Here, we analysed the relationship between line size in terms of number of catheter lumens and CLABSI incidence rate in paediatric patients.

Methods: A cross-sectional retrospective study was conducted in St. Mary's Hospital, London, examining CLABSI incidence in paediatric patients. Data was collected retrospectively from 344 paediatric patients with a central line inserted between January 2014 to June 2021 whilst below the age of 18 years. Data collected included patient demographics, number of catheter-days, line type, line size, number of lumens and presence of CLABSIs. Entries with incomplete data or ambiguous parameters were removed, leaving 259 patients.

Results: A total of 259 patients were included in the final analysis, totalling 43,046 catheter-days and 45 CLABSIs identified. CLABSI rate per thousand catheter-days was calculated separately according to the number of lumens: single 0.41 (n=136), double 1.16 (n=45), triple 2.25 (n=78). The typical range reported in literature is 1.0 to 2.7. Patient mean age at line insertion was 92.08 months \pm 67.9 SD. A Mann-Whitney U-Test showed a significant association between the number of lumens and CLABSI rate ($p=0.03005$).

Conclusions/Learning Points: There is an association observed between the number of lumens and CLABSI rate per thousand catheter-days in the paediatric population, which corroborates with the current literature. Multivariate analysis should be done to control for other variables to further confirm the relationship between the number of lumens and CLABSI rates.

EP366 / #1011

Topic: AS12. Health associated infections, infection prevention and control

IMPACT OF COVID-19 PANDEMIC ON ANTIMICROBIAL RESISTANCE: TWO PARALLEL GLOBAL THREATS

E-Posters

E-POSTER VIEWING

Dimitra Dimopoulou¹, Michael Polemis², Kyriaki Tryfinopoulou², Nikos Spyridis³, Maria Tsolia⁴, Theoklis Zaoutis⁵

¹National and Kapodistrian University of Athens, Second University Department Of Pediatrics, "p. & A. Kyriakou" Children's Hospital Of Athens, Athens, Greece, ²National Public Health Organization, Central Public Health Laboratory, Vari, Greece, ³National and Kapodistrian University of Athens, Second Department Of Pediatrics, Athens, Greece, ⁴National and Kapodistrian University of Athens, Second Department Of Pediatrics, "p. & A. Kyriakou" Children's Hospital, Athens, Greece, ⁵National Public Health Organization, President, Athens, Greece

Backgrounds: Antimicrobial resistance (AMR) is a major global threat and was already spreading rapidly before the emergence of COVID-19. The impact of the pandemic on AMR may be more pronounced in low and middle-income countries where antibiotic consumption is already high. This study aims to assess changes on AMR during the COVID-19 pandemic at hospital level, as documented by the WHONET-Greece AMR surveillance network.

Methods: A retrospective nationwide prevalence multicenter study was conducted in all paediatric departments, representing the 7 Regional Health Directorates of Greece. Routine susceptibility data of Gram-negative and Gram-positive bacterial isolates from blood and respiratory specimens were used in order to identify potential differences in AMR trends during the two study periods: January 2019–February 2020 and March 2020–December 2021. The analysis was stratified by organism, antimicrobial, ward and specimen type.

Results: Significant differences in the slope of non-susceptibility trends were identified in *Acinetobacter baumannii* blood isolates to ciprofloxacin (42.8%vs100%, $p=0.006$) and colistin (0%vs62.5%, $p=0.003$); ESBL *Klebsiella pneumoniae* blood (9.2%vs36.5%, $p<0.001$) and respiratory isolates (5.1%vs28.2%, $p=0.012$); and *Pseudomonas aeruginosa* respiratory isolates to ciprofloxacin (16.6%vs39.6%, $p=0.005$) and aztreonam (33.8%vs57.7%, $p=0.05$). Non-susceptibility trends of *Staphylococcus aureus* isolates to oxacillin and *Enterococcus faecium* isolates to glycopeptides remained largely unchanged. Similarly, non-susceptibility trends in ICUs remained stable during the study period.

Conclusions/Learning Points: Preliminary results on AMR trends during the COVID-19 pandemic in Greek paediatric wards indicate an increase in key gram-negative bacteria but not on gram positive. Further analysis on antibiotic prescribing during the same period will prove a possible causative relationship between antibiotic use during the pandemic and AMR.

EP367 / #715

Topic: AS12. Health associated infections, infection prevention and control

SUCCESSFUL MANAGEMENT OF DISSEMINATED SAPROCHAETE CLAVATA INFECTION IN A CHILD

E-Posters

E-POSTER VIEWING

Zeynep Ergenç¹, Sevgi Aslan¹, Seyhan Yılmaz¹, Burcu Taş², Ömer Doğru², Nurşah Eker², Eda Kepenekli¹, Ahmet Koç²

¹Marmara University School of Medicine, Pediatric Infectious Diseases, Istanbul, Turkey, ²Marmara University School of Medicine, Pediatric Hematology And Oncology, Istanbul, Turkey

Title of Case: SUCCESSFUL MANAGEMENT OF DISSEMINATED SAPROCHAETE CLAVATA INFECTION IN A CHILD

Background: Saprocheata clavata is a filamentous yeast-like fungus and causes severe and often fatal invasive infections in immunocompromised hosts. Here we present a successfully managed catheter-related disseminated Saprocheata clavata case.

Case Presentation Summary: A 15-year-old girl with acute myeloid leukemia was admitted with febrile neutropenia while under posaconazole prophylaxis. On the 5th day of hospitalization, yeast growth was reported in the central venous catheter blood culture of the patient who was under vancomycin, meropenem, and liposomal amphotericin B treatments. Intravenous voriconazole was added to the treatment when hypotension and respiratory distress were observed. The catheter was removed. Catheter blood cultures and 3 consecutive peripheral blood cultures yielded Saprocheata clavata. Antifungal susceptibility test resulted as follows; the minimum inhibitory concentration (MIC) value was 0.5 for liposomal amphotericin B, 0.12 for voriconazole, 0.5 for posaconazole, and <0.06 for flucytosine. However, flucytosine was available only in oral form and it can be given for 15 days. After the flucytosine treatment stopped, the fever recurred, and abdominal ultrasonography showed fungal balls in the kidneys bilaterally. On the 45th day of liposomal amphotericin B and voriconazole treatments, oral flucytosine could be added to the treatment again, and on the 52nd day, an allogeneic bone marrow transplantation was performed. The lesions were regressed in follow-up abdomen MRI and the patient was discharged with oral flucytosine and posaconazole combination on the 90th day of liposomal amphotericin B and voriconazole. She is now in the third month after discharge and had no progression.

Learning Points/Discussion: Management of Saprocheata clavata infections can be problematic especially in immunosuppressed patients. Antifungal combinations containing flucytosine can increase the success of treatment.

Topic: AS12. Health associated infections, infection prevention and control

ANTIBIOTIC PROPHYLAXIS FOR SURGICAL PROCEDURES, EVALUATION FROM A TERTIARY PAEDIATRIC HOSPITAL

E-Posters

E-POSTER VIEWING

Carlos Grasa¹, Nathalia Gerig¹, Isabel San Juan², Virginia Santana³, Paula Rodriguez Molino³, Sara Gallego², Claudia García Vaz², Lucía Hernández Rivas², Mercedes Castro Martínez², Vanessa Pachón Olmos², Enrique Sanz Olea², Luis Escosa-García¹, Laura Montes³, Luis Castro⁴, Ana Méndez-Echevarría¹, Pascual Sanabria Carretero⁴, Teresa Del Rosal¹, Talia Sainz³, Milagros García-López Hortelano⁵, Clara Udaondo⁶, Luis Alonso³, Javier Aracil³, Cristina Ots³, Francisco Reinoso-Barbero⁴, Ana Robustillo², Maria Jose Mellado¹, Cristina Calvo¹, Fernando Baquero-Artigao¹

¹Hospital Universitario La Paz, Paediatric Infectious Diseases Unit, Department Of Paediatrics, Madrid, Spain, ²Hospital Universitario la Paz, Preventive Medicine, Madrid, Spain, ³La Paz University Hospital, Pediatrics And Infectious Diseases, Madrid, Spain, ⁴Hospital Universitario la Paz, Anesthesiology, Madrid, Spain, ⁵Hospital La Paz, Pediatric Infectious Diseases, Madrid, Spain, ⁶Hospital Universitario la Paz, Paediatrics, Madrid, Spain

Backgrounds: Adequate use of surgical antibiotic prophylaxis (SAP) reduces incidence of wound infections; but misuse of SAP may cause side effects and contribute to antimicrobial resistance. The aim of this report is to analyse the SAP in our hospital in order to improve antibiotic use.

Methods: Retrospective analysis of SAP over 4 weeks (May 2021) for all surgical procedures in a tertiary paediatric centre. Episodes were evaluated by an external group according to local guidelines, reviewing electronic clinical records of patients.

Results: 369 surgical procedures were evaluated: 246 clean, 119 clean-contaminated, 3 contaminated and 1 dirty. A total of 204 procedures received SAP, although there were 20 (5.4%) where SAP was indicated but not registered as administered. Appropriate selection of antibiotic was observed in 164 cases (80.4%): amoxicillin-clavulanate was the most common (46.7%), followed by cefazolin (34.3%) and ceftriaxone (13.2%). Combination of 2 antibiotics was used in 9 episodes. Extended-duration of prophylaxis was observed in 74 episodes (36.3%); recorded reasons for longer duration: prophylaxis in 31 (42%), due to keeping surgical drainage in 21 (28.4%), not-described in 15 (20.3%), infection in 3 (4%), fever in 2 (3%), and other in 15 (12.2%). Overall evaluation of SAP (antibiotic, dose, time and duration) was adequate in 27% (55/204), being time of administration the most common reason for incorrect SAP (68.7%), followed by duration (23.9%), wrong dosing (23.1%) and wrong antibiotic (19.6%).

Conclusions/Learning Points: Appropriateness of SAP should be improved, especially in terms of time of administration, but also for choice of antibiotic, duration and dosing. Adequate record of SAP is essential to monitor this activity and impact in the quality of antibiotic prescription, serving as key data for future interventions.

EP370 / #1283

Topic: AS12. Health associated infections, infection prevention and control

PECULIARITIES OF BRONCHIOLITIS IN INFANTS AND TODDLERS UNDER 2 YEARS OF AGE BEFORE COVID 19 PANDEMIC AND DURING THE PANDEMIC

E-Posters

E-POSTER VIEWING

Alexandra Antonela Obaciu¹, [Alexandra Grecu](#)¹, Anca Ilea¹, Laura Bleotu¹, Oana Falup-Pecurariu^{1,2}

¹Children's Emergency Clinic Hospital Brasov, Romania, Pediatrics, Brasov, Romania, ²Transilvania University, Faculty Of Medicine, Brasov, Romania

Backgrounds: Acute bronchiolitis is one of the most common causes of hospitalization in infants under 2 years old. Respiratory syncytial virus is the most frequently identified virus in bronchiolitis, followed by rhinovirus, adenovirus, parainfluenzae virus, and coronavirus. Objectives: To compare the burden of bronchiolitis before COVID 19 pandemic, and during the pandemic in Brasov county, to evaluate the need for antibiotics, corticosteroid therapy and inhalation therapy at the studied population.

Methods: Prospective ongoing study was conducted on infants and toddlers under 2 years of age hospitalized between 1 January 2019 - 31 December 2021 at the Children's Emergency Clinical Hospital Brasov for Bronchiolitis.

Results: We included in our study a total of 1410 patients (643 - 2019, 302 – 2020, 465 – 2021). Most of the patients with bronchiolitis were boys (62.83% - 2019, 55.5% - 2020) and came from rural part. Average length of hospitalizations for Bronchiolitis was 7.20. The therapy administered in our hospital was: inhalation therapy - hypertonic saline, nebulized bronchodilators or epinephrine, corticosteroids 77.82% - 2019, 80.13% - 2020, antibiotics 46.95% - 2019, 63,24 % - 2020.

Conclusions/Learning Points: The number of bronchiolitis decreased by half in pandemic years due to preventive hygiene measures, use of facial masks, social distancing and lockdown.

EP371 / #1533

Topic: AS12. Health associated infections, infection prevention and control

CENTRAL LINE-ASSOCIATED BLOODSTREAM INFECTIONS (CLABSIS) IN PEDIATRIC ONCOLOGY PATIENTS

E-Posters

E-POSTER VIEWING

Georgios Totikidis¹, Kiriaki Kotsoglanidou¹, Maria Lamprou¹, Vasiliki Antari², Lambrini Damianidou², Eleni Papadimitriou³, Eleni Vagdatli⁴, Elias Iosifidis⁵, Emmanuel Roilides⁵, Evgenia Papakonstantinou¹

¹Hippokration Hospital of Thessaloniki, Pediatric Oncology Department, Thessaloniki, Greece, ²Ippokratia Hospital of Thessaloniki, Paediatric Oncology Department, Thessaloniki, Greece, ³Aristotle University of Thessaloniki, 1st Department Of Pediatrics, Thessaloniki, Greece, ⁴Hippokration General Hospital, Department Of Microbiology, Thessaloniki, Greece, ⁵Aristotle University of Thessaloniki, Infectious Diseases Unit, 3rd Pediatric Department, Thessaloniki, Greece

Backgrounds: The aim of this study was to review central line associated bloodstream infections (CLABSIs) in children with cancer.

Methods: This was a retrospective study conducted in a 20-bed pediatric oncology department from 1/1/2019 to 15/7/2021. CDC criteria for CLABSI definition were used. Bacterial identification antimicrobial susceptibility testing were done with the automated Vitek II system.

Results: Among hospitalized children 22 patients had 27 CLABSI episodes. In all but one case, the culture was taken from a Central Venous Catheter (CVC). The prevalence of CLABSIs was 36.5%, higher in leukemias (57.1%). Among CLABSI episodes, 26 blood cultures were positive for bacterial pathogens, and one for fungus (*Candida parapsilosis*). Eleven different species of bacteria were isolated, with a predominance of Gram negative (17/27 63%). The most common bacteria were *Staphylococcus epidermidis* (6/27), followed by *Pseudomonas aeruginosa* (5/27), *Escherichia coli* (4/27) and *Klebsiella pneumoniae* (3/27). The mean CRP values in CLABSI cases was 113 mg/L, while in 38.5% of episodes it was > 100 mg/L. Neutropenia was reported in 67% of episodes at diagnosis, which in 52% of cases was severe. In 41% of cases the absolute neutrophil count was <0.1 k/ μ L. Antimicrobial susceptibility testing showed that 37.5% of the enterobacteriales isolated produced broad-spectrum β -lactamases, while 83% of *Staphylococcus epidermidis* were resistant to oxacillin. Mortality was 7.4%. CRP values in survivors were statistically significantly lower ($p < 0.001$) than those who deceased.

Conclusions/Learning Points: The prevalence of CLABSIs in our pediatric oncology patients is high. CLABSIs usually present with fever accompanied by neutropenia and high CRP. Gram (-) bacteria are the most common pathogens of CLABSIs. Knowledge of the epidemiology of CLABSIs is essential, as it is a commonly potentially life- threatening condition in pediatric cancer patients.

EP372 / #1094

Topic: AS12. Health associated infections, infection prevention and control

BLOOD STREAM INFECTIONS DURING EXTRACORPOREAL MEMBRANE OXYGENATION IN NEONATES AND CHILDREN: A RETROSPECTIVE AUDIT SPANNING 5 YEARS

E-Posters

E-POSTER VIEWING

Marianne Koenraads¹, Shirley Nolan², Alison Brady², Anand Wagh², Marie Horan², Christopher Parry³
¹Alder Hey Children's Hospital, Paediatric Infectious Diseases, Liverpool, United Kingdom, ²Alder Hey Children's Hospital, Paediatric Intensive Care, Liverpool, United Kingdom, ³University of Liverpool, Clinical Infection, Microbiology & Immunology, Liverpool, United Kingdom

Backgrounds: Bloodstream infections (BSI) are an important complication of extracorporeal membrane oxygenation (ECMO) and can significantly impact on morbidity and mortality. Overall prevalence rates between 6 and 33% have been described in previous studies. We aimed to describe the epidemiology of bloodstream infections during ECMO in a tertiary paediatric intensive care unit (PICU).

Methods: We conducted a retrospective analysis of all reported bloodstream infections in patients undergoing ECMO between 1st January 2016 to 31st December 2020. Data collected included duration of ECMO, details of the infectious organism and survival to 30 days post decannulation.

Results: A total of 150 patients required ECMO during the study period and 169 ECMO runs were performed with a total of 1432 ECMO days. The median duration of ECMO was 6 days. A total of 48 organisms were identified in 40 patients, of which 17 organisms were deemed contaminants and 3 patients had sepsis prior to the ECMO cannulation. There were 16 episodes of a secondary BSI whilst on ECMO, 4 episodes of CLABSI and 8 episodes of ECMO associated BSI. Overall significant ECMO infection prevalence was 16.6% of the ECMO runs and the infection rate was 19.6 episodes per 1000 ECMO days. Overall survival to 30 days post ECMO decannulation was 61.3% (92/150). However in the patients with an infection survival was only 47.5% (19/40).

Conclusions/Learning Points: Neonates and children undergoing ECMO are at high risk of infections and have high rates of mortality. Strategies and guidelines to prevent infections in this high risk group remain a priority.

EP373 / #352

Topic: AS12. Health associated infections, infection prevention and control

HEALTHCARE ASSOCIATED INFECTIONS IN A PEDIATRIC CARDIAC INTENSIVE CARE UNIT, GUATEMALA, 2016-2021

E-Posters

E-POSTER VIEWING

Herberth Maldonado^{1,2}, Aura Chiroy¹, Glenda Najera¹

¹Unidad de Cirugía Cardiovascular de Guatemala, Control Y Prevención De Infecciones, Guatemala, Guatemala, ²Universidad del Valle de Guatemala, Centro De Estudios En Salud, Guatemala City, Guatemala

Backgrounds: Surgical site infections (SSI) and Device-Associated Healthcare Infections (DA-HAI) result in increased morbidity and mortality. Scant data are available on SSI and DA-HAI burden in pediatric cardiac intensive care units (PCICU), particularly from low-middle income countries (LMICs).

Methods: We report results from active SSI and DA-HAI surveillance from January 2016 to December 2021. A dedicated infection prevention and control team collected denominators, clinical and laboratory data using definitions adapted from the Center for Diseases Control (CDC) National Healthcare Safety Network (NHSN) for SSI, ventilator-associated pneumonia (VAP), central line-associated bloodstream infection (CLABSI), and catheter-associated urinary tract infection (CAUTI).

Results: During the reporting period, 1630 children underwent open-heart surgery, and the incidence of SSI was 1.96 per 100 surgeries (CI 95%: 1.4, 2.7). At the PCICU, for a total of 7,376 patient-days, we report the following DA-HAI rates: 16.5 VAP episodes per 1,000 ventilator-days (CI 95%: 12.5, 21.4); 5.7 CLABSI episodes per 1,000 central line-days (CI 95%: 4.1, 7.8); 7.2 CAUTI episodes per 1,000 urinary catheter-days (CI 95%: 5.1, 10.3).

Conclusions/Learning Points: Our reported SSI rates are similar to those reported in cardiac units from high-income countries whereas the DA-HAI rates are greater than those reported in PCICUs by the NHSN or the International Nosocomial Infection Control Consortium (INICC). Multimodal interventions are necessary to reduce the burden of DA-HAI. No increase in infections was observed during the pandemic.

EP374 / #471

Topic: AS12. Health associated infections, infection prevention and control

OVERVIEW OF INFECTIOUS MONONUCLEOSIS, AMONG CHILDREN ADMITTED TO THE INFECTIOUS PEDIATRICS SERVICE BETWEEN JANUARY 2018 AND DECEMBER 2019

E-Posters

E-POSTER VIEWING

Bashkim Nezaj, Gjerogjina Kuli Lito, Ferit Zavalani, Raida Petrela, Inva Gjeta, Blerina Gjoni, Diana Shtembari, Brikena Dedo
University Hospital Center, Infectious Diseases, Tirana, Albania

Title of Case: Overview of Infectious Mononucleosis, among children admitted to the Infectious Pediatrics service between January 2018 and December 2019

Background: OBJECTIVE: To present epidemiological data, diagnosis, peak study of Infectious Mononucleosis through a retrospective-descriptive study

Case Presentation Summary: MATERIAL AND METHOD: 101 children aged 1-14 years admitted to the Infectious Pediatrics service between January 2018 and December 2019 were enrolled. The confirmed diagnose was: Infectious Mononucleosis. Medical records were reviewed. RESULTS: The 101 children in the study belong to the age of 1-14 years, grouped in 3 age groups: 1-5 years - 54 cases - 53.4% . 6-10 years -36 cases - 35.6% > 10 years- 11 cases - 10.89% By gender 29 males (54.7%) and 24 females (45.3%) in 2018 and 30 Males (62.5%) and 18 Females (37.5%) in 2019. According to seasonality: In 2018, 18 cases (33.9%) in spring, 7 cases (13.2%) in summer, 14 cases (26.4%) in autumn and 14 cases (26.4%) in winter. In 2019, 19 cases in spring (39.5%), 6 cases in summer (12.5%) ,9 cases in autumn (18.75%) and 14 cases in winter (20%) All 101 cases (100%) had fever, 96 cases (95%) had fatigue, 63 cases (62.3%) had pharyngo-tonsillitis, 64 cases (63.3%) had cervical lymphadenopathy, 30 cases (29.7%) had liver involvement and lien Laboratory examinations: leukocytosis>10.000 in 65 cases (64.3%), lymphomonocytosis in 96 cases (95.5%), atypical lymphocytes in 7 cases (6.9%).

Learning Points/Discussion: CONCLUSION: The most affected age group was 1-5 years old.. The disease is most common in males. The male/female ratio was 2:1. The disease is more frequent in spring.. The disease is most common in urban areas.

EP375 / #671

Topic: AS12. Health associated infections, infection prevention and control

OVERVIEW OF INFECTIOUS MONONUCLEOSIS, AMONG CHILDREN ADMITTED TO THE INFECTIOUS PEDIATRICS SERVICE BETWEEN JANUARY 2018 AND DECEMBER 2019

E-Posters

E-POSTER VIEWING

Bashkim Neza¹, Gjeorgjina Kuli-Lito¹, Raida Petrela¹, Ferit Zavalani¹, Blerina Gjoni¹, Diana Shtembari¹, Inva Gjeta¹, Brikena Dedo²

¹Mother Theresa Hospital, Paediatrics, Tirana, Albania, ²Primary Health Care, Paediatrics, Tirana, Albania

Backgrounds: To present epidemiological data, diagnosis, peak study of Infectious Mononucleosis through a retrospective-descriptive study.

Methods: 101 children aged 1-14 years admitted to the Infectious Pediatrics service between January 2018 and December 2019 were enrolled. The confirmed diagnose was: Infectious Mononucleosis. Medical records were reviewed.

Results: The 101 children in the study belong to the age of 1-14 years, grouped in 3 age groups: 1-5 years - 54 cases (28 cases in 2018 and 26 cases in 2019) - 53.4% . 6-10 years -36 cases (20 cases in 2018 and 16 cases in 2019) - 35.6% > 10 years- 11 cases (5 cases in 2018 and 6 cases in 2019) - 10.89% By gender 29 males (54.7%) and 24 females (45.3%) in 2018 and 30 Males (62.5%) and 18 Females (37.5%) in 2019. According to seasonality: In 2018, 18 cases (33.9%) in spring, 7 cases (13.2%) in summer, 14 cases (26.4%) in autumn and 14 cases (26.4%) in winter. In 2019, 19 cases in spring (39.5%), 6 cases in summer (12.5%) ,9 cases in autumn (18.75%) and 14 cases in winter (20%) All 101 cases (100%) had fever, 96 cases (95%) had fatigue, 63 cases (62.3%) had pharyngo-tonsillitis, 64 cases (63.3%) had cervical lymphadenopathy, 30 cases (29.7%) had liver involvement and liver Laboratory examinations: leukocytosis>10.000 in 65 cases (64.3%), lymphomonocytosis in 96 cases (95.5%), atypical lymphocytes in 7 cases (6.9%).

Conclusions/Learning Points: The most affected age group was 1-5 years old.. The disease is most common in males. The male/female ratio was 2:1. The disease is more frequent in spring. The disease is most common in urban areas.

EP376 / #1836

Topic: AS12. Health associated infections, infection prevention and control

HEPATIT A IN A CHILD

E-Posters

E-POSTER VIEWING

Ergena Neziri¹, Laureta Sadedini¹, Gjeorgjina Kuli-Lito², Ferit Zavalani², Mirzana Kapllanaj³, Diana Shtembari², Suela Demiraj⁴, Bashkim Neza²

¹Mother Teresa Hospital Center, Albania, Pediatric Emergency Department, tirana, Albania, ²Mother Teresa Hospital Center, Albania, Pediatric Infection Disease Department, tirana, Albania, ³Mother Teresa Hospital Center, Albania, Pediatric Onco-hematology Department, tirana, Albania, ⁴Hygea Hospital Albania, Hygea Hospital Albania, tirana, Albania

Title of Case: HEPATIT A IN A CHILD

Background: Hepatitis A is an inflammation of the liver caused from picornavirus HAV-RNA. It is transmitted through ingestion of contaminated food and water or through direct contact with an infected person. Almost everyone recovers fully from hepatitis A with a lifelong immunity and rarely can cause fulminant hepatitis

Case Presentation Summary: An 8 year-old boy was brought to the Emergency Department with fever since 1 week, vomiting and abdominal pain since 3 days, high colored urine since 2 days. The boy was not tolerating any food or water, pain in right upper abdomen and not allowing anybody to touch it. Examination: The child was looking sick, pale and icterus. Mild dehydration, edema, hepatomegaly were present. Liver was palpable about 10 cm below the costal margin, soft and tender, at the right upper quadrant. The child was febrile 38.5 °C and was hemodynamically stable. On the third day the clinical conditions of the patients were progressing, with vomiting, headache, malaise, lethargy and mental confusion. Laboratory findings: leucocyte 13,500/mm³, with relative thrombocytopenia 201x10³, Hb 12g/dl, alkaline phosphatase 2350 U/L, AST 650 U/L, ALT 735 U/L, total bilirubin 7mg/dl, hypoalbuminemia, IgM HAV positive. Serologies for Hepatitis B, C and enteric fever were negative. Ultrasound examination revealed right-sided mild pleural effusion, gall bladder wall thickening of 5 mm suggestive of acalculous cholecystitis, moderate free fluid in abdomen and hepatomegaly. The patient recovered spontaneously without sequelae. He was managed conservatively. By third week of illness on repeat ultrasound, the mild pleural effusion, ascites and acalculous cholecystitis had resolved and biochemical parameters improved by fifth week of illness

Learning Points/Discussion: Viral Hepatitis is an important health problem in developing and developed countries of the world. Infection in children is almost always asymptomatic or mild symptoms and rarely fulminant hepatic failure can occur. The cases should be isolated till the clinical manifestation subsides

EP377 / #578

Topic: AS12. Health associated infections, infection prevention and control

NUTRITIONAL STATUS OF HIV-EXPOSED CHILDREN IN A TERTIARY HEALTH CENTRE IN NORTHWESTERN NIGERIA.

E-Posters

E-POSTER VIEWING

Ben Onankpa, Yusuf Tahir, Ridwan Jega

Usmanu Danfodiyo University Teaching Hospital(UDUTH), Sokoto, Paediatrics, Sokoto, Nigeria

Backgrounds: Background: Optimal nutrition faces challenges in the face HIV-infection in the developing countries due to MTCT of HIV infection. We determined the nutritional status of HIV-exposed young children seen in Usmanu Danfodiyo University Teaching Hospital, (UDUTH) Sokoto, Northwestern Nigeria.

Methods: A prospective observational study among HIV-exposed children at the Paediatric ART Clinic, UDUTH, Sokoto between January 1st, and December 31st 2018. The demographics and anthropometrics of the children were documented. Nutritional status was determined using WHO growth standards and socio-economic status determined using Oyedeji's classification scheme. Data were analyzed using SPSS version 22.0 and p-value ≤ 0.05 was taken as significant.

Results: One hundred and sixty-four HIV-exposed children were studied. Ninety-nine (60.4%) were aged 12.1 – 18.0 months, mean age was 16.7(± 3.5) months. Ninety-nine (60.4%) were from lower socio-economic class. Majority (78%) was exclusively breastfed and initiated complementary feed by 6 month of age. Forty-five (27.4%), 30 (18.3%) and 22 (13.4%) of the children were stunted, underweight and wasted respectively. The rate of undernutrition was found to be significantly related to the age of the child ($p=0.03$), socio-economic status of the family ($p=0.008$) and the timing of maternal HAARTs ($p= 0.01$).

Conclusions/Learning Points: Conclusion: Nutritional status of the studied children was suboptimal and significant number was stunted and underweight in our environment; timely nutritional interventions to stem the trend is apt.

Topic: AS12. Health associated infections, infection prevention and control

SURGICAL SITE INFECTIONS AFTER PAEDIATRIC APPENDECTOMY - A RETROSPECTIVE ANALYSIS FROM UNIVERSITY MEDICAL CENTRE LJUBLJANA, SLOVENIA

E-Posters

E-POSTER VIEWING

Veronika Osterman^{1,2}, Ana Prisljan¹, Uros Mazic¹, Polona Studen Pauletic^{1,3}, Julija Pavcnik¹, Joze Maucec^{1,4}, Diana Gvardijancic^{1,4}

¹University Medical Centre Ljubljana, Department Of Paediatric Surgery, Ljubljana, Slovenia, ²University Medical Centre Ljubljana, Hospital Infection Prevention And Control Services, Ljubljana, Slovenia, ³General Hospital Jesenice, Department Of General And Abdominal Surgery, Jesenice, Slovenia, ⁴University Medical Centre Ljubljana, Department Of Abdominal Surgery, Ljubljana, Slovenia

Backgrounds: Appendectomy is considered at the top of emergency surgical procedures worldwide and its reported surgical site infection (SSI) rates in children vary from 1.6-20%. Abdominal SSIs add substantially to the morbidity of patients and increase treatment costs.

Methods: In the absence of recent studies focusing on SSIs post-appendectomy in our region, the aim of this retrospective study was to determine the SSI rates in children following appendectomy at the Department of Paediatric Surgery, University Medical Centre Ljubljana, Slovenia. The subjects were followed for 30 days, data were collected through pre- and post-operative examinations and telephone follow-ups.

Results: In the three-month analyzed period, 47 children were included in the study, of which 57.4% were boys. Median age was 10 years and 5 months (range: 3 years 8 months - 14 years 6 months). According to the ASA classification 85% of children were classified as A1 and 15% as A2. All children received appropriate preoperative antibiotic prophylaxis. Operation was defined as urgent in all cases. Laparoscopic approach was used in 78.7% and average duration of surgery was 48 minutes. Surgical wounds were identified as contaminated in 77% (W3) and dirty in 23% (W4). The appendix was described as phlegmonous in 55%, gangrenous in 27%, and perforated in 4%. Postoperative antibiotic therapy was introduced in 19%. In the analyzed period the overall incidence rate of SSI was 2.1% with E. coli being the sole isolate. SSIs occurred on average 11 days after surgery.

Conclusions/Learning Points: Compared to the published data, the incidence of SSIs after appendectomy in our department was low, with the limitation of the small sample size. Implementation of SSI prevention bundles, active surveillance and regular data analysis are crucial in successful managing of SSIs.

EP379 / #1309

Topic: AS12. Health associated infections, infection prevention and control

SURGICAL SITE INFECTIONS AFTER HYPOSPADIA REPAIR - A RETROSPECTIVE ANALYSIS FROM UNIVERSITY MEDICAL CENTRE LJUBLJANA, SLOVENIA

E-Posters

E-POSTER VIEWING

Veronika Osterman^{1,2}, Ana Prisljan¹, Uros Mazic¹, Adnan Arafat³, Blaze Podnar^{1,3}, Robert Kordic^{1,3}
¹University Medical Centre Ljubljana, Department Of Paediatric Surgery, Ljubljana, Slovenia, ²University Medical Centre Ljubljana, Hospital Infection Prevention And Control Services, Ljubljana, Slovenia, ³University Medical Centre Ljubljana, Department Of Urology, Ljubljana, Slovenia

Backgrounds: Complications in hypospadias surgery are higher than in other reconstructive procedures. Surgical site infection (SSI) can be a potential disaster as it may lead to disruption of hypospadias repair and child voiding into an open wound.

Methods: In the absence of recent local data, the aim of this retrospective study was to determine the characteristics of surgical interventions and SSI rates in children following hypospadias repair at the Department of Paediatric Surgery, University Medical Centre Ljubljana, Slovenia. All subjects were followed for 30 days, data were collected through pre- and post-operative examinations and telephone follow-ups.

Results: In the three-month analyzed period, 21 boys were included in the study. Median age was 27 months. According to the ASA classification 95% of children were classified as A1 and 5% as A3. All children received appropriate preoperative antibiotic prophylaxis with gentamicin. Operation was defined as elective in all cases with average duration of 1 hour and 20 minutes. All surgical wounds were identified as clean (W2). The overall incidence rate of SSI was 19% with 75% of all SSIs occurring in patients with middle or posterior hypospadias. SSIs occurred on average 5 days after surgery (range: 3-7 days) and all SSIs were determined as superficial. Microbiological swabs remained sterile. Postoperatively, children received an average of 2.9 doses of gentamicin, which is consistent with the average urinary catheter placement days. After removal of the urinary catheter, antibiotic therapy was continued in 5%.

Conclusions/Learning Points: Comparable to the published data, the incidence of SSI after hypospadias repair in our department was high, with the expected highest incidence occurring in patients with middle or posterior hypospadias. Due to the small sample size, further studies are needed for SSI risk stratification.

EP380 / #1403

Topic: AS12. Health associated infections, infection prevention and control

VENTILATOR ASSOCIATED EVENTS (VAE) IN PATIENTS HOSPITALIZED IN A PEDIATRIC INTENSIVE CARE UNIT (PICU) DURING 2017-2019: EPIDEMIOLOGY, RISK FACTORS AND OUTCOME

E-Posters

E-POSTER VIEWING

Dimitra Papakyritsi¹, [Elias Iosifidis](#)², Serafia Kalamitsou³, Elisavet Chorafa¹, Eleni Volakli³, Yolanda Peña-López⁴, Maria Sdougka³, Emmanuel Roilides²

¹Hippokration Hospital of Thessaloniki, 3rd Pediatric Clinic, Thessaloniki, Greece, ²Aristotle University of Thessaloniki, Infectious Diseases Unit, 3rd Pediatric Department, Thessaloniki, Greece, ³Hippokration Hospital of Thessaloniki, Pediatric Intensive Care Unit, Thessaloniki, Greece, ⁴Vall d'Hebron Barcelona Hospital Campus, Pediatric Critical Care Department, Barcelona, Spain

Backgrounds: Ventilator-associated pneumonia (VAP) is one of the most common health-care associated infections in pediatric ICUs (PICU), but its definite diagnosis remains controversial. CDC Ventilator-Associated Event (VAE) module (validated only in adults) constitutes a new approach for VAP surveillance.

Methods: We described epidemiological characteristics of PICU's VAE cases, investigated possible risk factors and evaluated three different diagnostic VAE criteria in a PICU during 2017-2019. Patients 35d-16y old receiving mechanical ventilation were included. Epidemiological, clinical, laboratory characteristics and ventilator settings were retrieved from medical records and analyzed. Assessment of "oxygen deterioration" for tier 1 CDC VAE module was made using each of 3 pathways: 1) adult [increase of daily minimum fraction of inspired oxygen (FiO_2) ≥ 0.2 or positive end expiratory pressure (PEEP) ≥ 3 cmH₂O for 2 days], 2) US Pediatric [increase of $FiO_2 \geq 0.25$ or mean airway pressure (MAP) ≥ 4 cmH₂O for 2 days] and 3) European (increase of $FiO_2 \geq 0.2$ or PEEP ≥ 2 cmH₂O for 1 day or increase of $FiO_2 \geq 0.15$ and PEEP ≥ 1 cmH₂O for 1 day) criteria.

Results: Among 326 children admitted to the PICU, 301 received mechanical ventilation. The incidence rate of VAE according to adult, US pediatric and European pediatric criteria was 4.7, 6 and 9.7 per 1000 ventilator-days, respectively. Results revealed statistically significant correlation of all three algorithms with adverse outcomes, including mortality.

Conclusions/Learning Points: All VAE algorithms were associated with adverse outcomes, including higher mortality rates. Our findings highlight the need for a unified pediatric VAE definition, aiming improvement of preventive strategies.

EP381 / #1922

Topic: AS12. Health associated infections, infection prevention and control

VENTILATOR-ASSOCIATED RESPIRATORY INFECTIONS AND EUROPEAN PEDIATRIC VENTILATOR-ASSOCIATED EVENT CRITERIA

E-Posters

E-POSTER VIEWING

Joan Miquel Pujol-Morro¹, David Roca¹, Guiem Vaquer¹, Jordi Rello², Sofia Tejada², Sergio Ramírez-Estrada³, Elias Iosifidis⁴, Yolanda Peña-López¹

¹Vall d'Hebron Barcelona Hospital Campus, Pediatric Critical Care Department, Barcelona, Spain, ²Vall d'Hebron Research Institute, Clinical Research/epidemiology In Pneumonia & Sepsis (crips); Instituto De Salud Carlos Iii, Ciber De Enfermedades Infecciosas, Barcelona, Spain, ³Clínica Corachan, Critical Care Department, Barcelona, Spain, ⁴Aristotle University of Thessaloniki, Infectious Diseases Unit, 3rd Pediatric Department, Thessaloniki, Greece

Backgrounds: The Centers for Disease Control and Prevention (CDC) broadened the focus of surveillance from ventilator-associated pneumonia (VAP) to ventilator-associated event (VAE) for quality purposes. We aimed to characterize VAE in pediatric VARI episodes using CDC criteria (adult VAE, children: US-PedVAE) and the European pediatric criteria (EU-PedVAE). Secondary objective: subcategorize ventilator-associated respiratory infections (VARI) using EU-PedVAE definition and compare outcomes between them.

Methods:: Cohort study using retrospective review of medical records and prospectively collected quality improvement VAE/VARI database from January 2017 to March 10th, 2020 in a 16-bed-PICU. VARI, including VAP and ventilator-associated tracheobronchitis (VAT), were assessed using the 2008-CDC definitions. Exclusion criteria: previous ventilation, extracorporeal life support, right-to-left shunt or pulmonary hypertension. In patients with more than one episode of mechanical ventilation (MV), only the first was considered.

Results: A total of 33 VARI episodes and 1,342 ventilator-days were analyzed. There were 29 VAT (87.9%) and 4 VAP (12.1%). Sixteen (48.5%) corresponded to early-onset VARI. Nine out of 33 VARI fulfilled any criteria: 2 adult VAE, 1 US-PedVAE, and 9 EU-PedVAE criteria. The duration of the episodes of MV in patients suffering from VARI was 10 (8-28) (median, IQR) and the duration of MV from the VARI onset was 5 (2-17). In VARI episodes meeting EU-VAE definition, a median of 7(3-26) ventilator-days from the VARI onset was documented, whereas the median of days from VARI onset to extubation was 4.5 (IQR 2-11.5) on those VARI episodes not meeting EU-VAE criteria (p=0.301).

Conclusions/Learning Points: All VAE criteria had low prevalence among VARI, being the EU-PedVAE definition the least restrictive. EU-PedVAE criteria might be used to identify VARI with worse outcomes.

Topic: AS12. Health associated infections, infection prevention and control

AFTER 2 YEARS OF COVID-HYGIENE RULES, DO THEY IMPACT ON THE PREVENTION OF FEBRILE NEUTROPENIA?

E-Posters
E-POSTER VIEWING

A. Garavelli, A. Castagana, J. Ruggiero, E. Borelli, V. Folsi, C. D'Ippolito, R. Fabian Schumacher
 University Children's Hospital, Hematology-oncology, Brescia, Italy

Backgrounds: Despite pharmacological, environmental and dietary prophylaxis, and strict hygiene rules, neutropenic fever remains the main reason for unscheduled admission to paediatric oncology wards. Since February 2020, the SARS-CoV-2 pandemic has forced everyone to practice careful hand hygiene, maintain social distance and wear masks, which has significantly reduced the number of infections and related hospitalizations in children. This study aims to test whether - and if so, to what extent - those COVID recommendations improve the protection of children undergoing anti-cancer treatment.

Methods:: We retrospectively compared the number of admissions for febrile neutropenia at “Ospedale dei Bambini”, Brescia in the 2-year-period from March 2018 to February 2020 (“pre-COVID”) with the number of admissions for the same reason from March 2020 to February 2022 (“in-COVID”), taking into account age, sex, length of stay and the total number of hospitalizations in paediatric oncology.

Results:

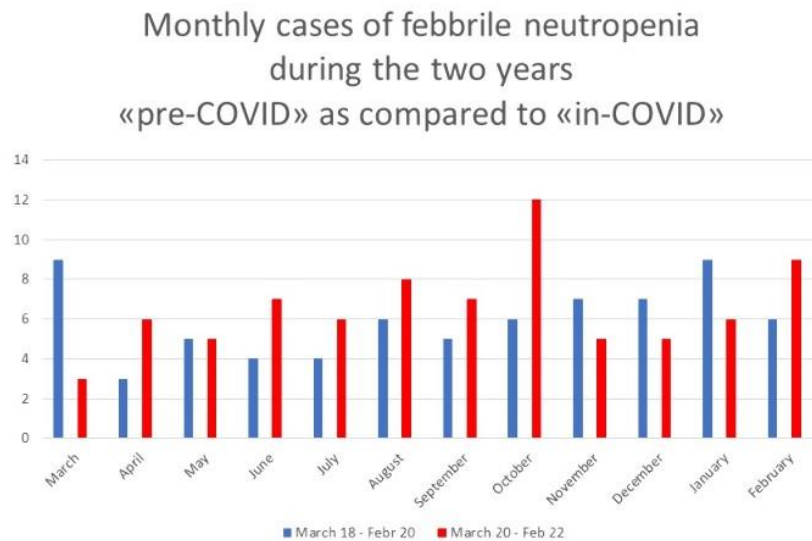

n=150

Figure1 shows the time course of admissions, with no significant difference in the numbers (71 vs 79) and percentages of admissions (9.9% vs 10.6%, $p > 0.05$) between the two periods. The age of the patients and the duration of hospital stays ("pre-COVID": mean age 7.9 years; median duration 7 days; "in-COVID": mean age 7.1 years; mean duration 9 days) also did not differ (t-tests > 0.05).

Conclusions/Learning Points: The incidence of fever in neutropenia was not affected by the large-scale introduction of anti-pandemic prevention policies suggesting that the hygiene measures normally taken by our patients/caregivers are effective in preventing infections transmitted by air or contact. It is also true that the new COVID-19 prevention rules have no impact on infections caused by the endogenous flora,

foodborne pathogens, and/or chemotherapy side effects. which remain the leading cause of hospitalisation for fever in neutropenia.

EP383 / #1319

Topic: AS12. Health associated infections, infection prevention and control

SUCCESSFULLY TREATED CARBAPENEM-RESISTANT ENTEROBACTERIACEAE (CRE) INVASIVE INFECTIONS IN A PEDIATRIC INTENSIVE CARE UNIT

E-Posters

E-POSTER VIEWING

Catarina Teixeira, Teresa Botelho, Joana Andrade, Rita Moinho, Carla Pinto, Leonor Carvalho, Andrea Dias

Hospital Pediátrico - Centro Hospitalar e Universitário de Coimbra, Paediatric Intensive Care, Coimbra, Portugal

Title of Case: Successfully treated Carbapenem-Resistant Enterobacteriaceae (CRE) Invasive Infections in a Pediatric Intensive Care Unit

Background: We present three cases of septic shock due to Carbapenem-resistant (CR) *Klebsiella pneumoniae*, requiring cardiovascular and invasive ventilatory support, successfully treated with a combination of ceftazidime-avibactam and tigecycline.

Case Presentation Summary: A 16-month-old child with congenital heart disease underwent surgical correction. On postoperative day 9, she developed septic shock, with possible abdominal starting point, and positive blood and urine cultures for CRE. Targeted antibiotic therapy was then initiated with ceftazidime-avibactam and amikacin. Posteriorly tigecycline was associated due to clinical deterioration and increased inflammatory markers. A 4-month-old infant with acute myeloid leukemia was admitted due to septic shock (CRE isolated in blood and peritoneal fluid), complicated with intestinal ischemia and emergent intestinal resection. Antibiotic therapy with meropenem (intermediate sensibility) and amikacin was started. Due to poor evolution, meropenem was replaced by ceftazidime-avibactam. Later, CRE and *Stenotrophomonas maltophilia* were also isolated in bronchoalveolar lavage culture (BLC). Tigecycline was associated. A 6-month-old infant was submitted to liver transplantation (LT) for liver cirrhosis. On day 4 after LT, intestinal perforation, and septic shock with isolation of CRE in blood, peritoneal fluid and BLC was observed. Targeted antibiotic therapy with ceftazidime-avibactam, gentamicin, and tigecycline was started. Due to persistently positive BLC, inhaled colistin was tried, with good response. All cases survived. Only one was previously screened for CRE, without colonization.

Learning Points/Discussion: CRE infection is a severe condition. Its treatment is challenging due to limited antibiotic options and scarceness of studies on therapeutic effectiveness in pediatrics. Bearing in mind the resistance emergence, the use of ceftazidime-avibactam and tigecycline must be rational but it is encouraging in terms of clinical response and survival.

EP384 / #1318

Topic: AS12. Health associated infections, infection prevention and control

**RAISING AWARENESS ABOUT HAND WASHING WHILE CONTACTING WITH NEWBORN PATIENT
- WHAT APPROACH IS BETTER FOR MEDICAL STAFF COMING OUTSIDE NICU?**

E-Posters

E-POSTER VIEWING

Oxana Turcanu, Maria Guzun

Clinical Municipal Hospital "Gheorghe Paladi", Perinatal Center, Neonatal Renimation Unit No.1,
Chisinau, Moldova

Backgrounds: Besides the NICU staff (tightly trained/monitored on hand hygiene), babies in our unit are contacting with general "visiting" non-permanent staff (same as for adult ICU) - laboratory workers, echographers, engineers.

Starting with 01.2018 we have a registry of nosocomial cultures - our spectrum (St.epidermidis) being different that for adult ICU (P.aeruginosa & A.baumannii), but most difficult dangerous cases to NICU were with last 2 bacterias.

Bimensual cultures from surfaces, staff hands, equipment didn't show the source of Pseudomonas & Acinetobacter in our unit. Anonimous observations showed insufficient compliance with hand washing procedures by "visiting" staff. We tested a few interventions to motivate them to change this risky behavior.

Methods: a) Evaluation meetings, usually relying on professional reprimands (still a tactique in former soviet countries).

b) Using a "paper request" with an inserted nice reminder about hand washing (offered to each "visiting" worker).

c) 15th October action "a flower for clean hands".

Results: Observational results: -The fastest improvement in hand washing timing & technique was observed in middle level & technical staff (65% of laboratory workers, 70% engineers) and slowest (35%) among physicians. Indirect results: -Blood/traheal aspirates - since 10.11.2018 we had only 1(+) culture of P.Aeruginosa (12.2021, long term ventilated baby) and no any A.baumannii (no proved cases of transmission from other hospital units), all cases of late bacterial growth being St.epidermidis and K.pneumoniae (main nosocomial bacterias in our NICU).

Conclusions/Learning Points: Although visual information on hand washing (ex. WHO posters) is useful in promoting hand hygiene, when speaking about targeting medical staff from different hospital settings - a more personal approach in raising awareness is likely to have a better outcome. Especially if this is done in a user-friendly way (not punishment tactic).

EP385 / #1062

Topic: AS12. Health associated infections, infection prevention and control

NOSOCOMIAL INFECTIONS IN THE NEONATAL INTENSIVE CARE UNIT DURING THE COVID-19 PANDEMIC

E-Posters

E-POSTER VIEWING

Johanna Velez-Velez, Zayhara Reyes-Bou, Lourdes Garcia-Fragoso, Ines Garcia-Garcia
University of Puerto Rico School of Medicine, Department of Pediatrics, Neonatology Section, San Juan, Puerto Rico

Backgrounds: Health care-associated infections in the Neonatal Intensive Care Unit (NICU) have serious consequences, including increased mortality, morbidity, hospital length of stay, and costs. Prevention of health care-associated infections is crucial for the survival and neurodevelopment of vulnerable infants. COVID-19 pandemic has raised awareness of infection prevention and control. Particularly, hand hygiene has received considerable attention. The aim of this study is to compare nosocomial infection rates before and after the COVID-19 pandemic in a Level IV NICU in Puerto Rico and assess changes in hand-hygiene practices in healthcare workers.

Methods: Retrospective review of the University Pediatric Hospital NICU antibiograms and patient censuses was carried out to compare the pre-pandemic period (March 2019-February 2020) and post-pandemic period (April 2020-March 2021) by determining infection rates/100 admissions. Anonymous survey to 28 healthcare workers was performed. Statistix 8.0 used for analysis. IRB approved.

Results: Monthly censuses during periods were similar. There were 23.9 nosocomial infections/100 admissions in the pre-pandemic period as compared to 37.5 during the pandemic ($p=0.0053$). For gram negative organisms, 8.1 nosocomial infections/100 admissions before and 14.5 during the pandemic ($p=0.0091$). Healthcare workers referred to have increased hand washing (86%) and sanitizing (93%) due to the pandemic.

Conclusions/Learning Points: Self-reported increased compliance with hand hygiene by healthcare workers did not decrease nosocomial infections in the NICU. Surprisingly, nosocomial infections were more prevalent during the pandemic period. This can be related to an increase in the demand for personal protection equipment during a period of limited resources. Hand hygiene techniques and nosocomial infections awareness need to be assessed to improve prevention. Self reported hand hygiene compliance may not provide the hand disinfection required to prevent transmission of pathogens.

EP387 / #865

Topic: AS13. COVID 19 and MIS-C

PEDIATRIC CORONAVIRUS DISEASE 2019 (COVID-19) AND MULTISYSTEM INFLAMMATORY SYNDROME (MIS-C) PROFILE IN REFERRAL HOSPITAL WITH HIGH INCIDENCE CASES

E-Posters

E-POSTER VIEWING

Riyadi Adrizain, Anggraini Alam, Mutiara Dewi, Djatnika Setiabudi
Hasan Sadikin General Hospital/Universitas Padjadjaran, Child Health, Bandung, Indonesia

Backgrounds: There have been 4,265,187 confirmed cases with 144.121 deaths from 3 January 2020 to 7 January 2022 in Indonesia, while as Desember 2020 in pediatric population There were 37,706 reported confirmed COVID-19 cases in which 175 cases resulted in death. MIS-C had their antibody-dependent enhancement (ADE) mechanism that cause shock, coagulopathy, and increase inflammatory markers, with the clinical manifestation reported fever as the most common symptoms, could disguise the diagnosis, especially in MIS-C because of negative result of Nucleic Acid Amplification Test (NAAT).

Methods: We collected pediatric patient that admitted to Hasan Sadikin General Hospital between January 1st to Desember 31st 2021 that admitted to Hasan Sadikin General Hospital with diagnosis Suspected Covid-19, the confirmed cases and patient that diagnose as MIS-C also to be distinguished, for MIS-C patient we collect age, gender, nutrition status, duration of fever before diagnose, laboratory finding and outcome

Results: During that period there were 313 suspected Covid-19 cases admitted, with 62 (19,8%) confirmed using NAAT, while MIS-C cases found in 5 children, most of the patient age is below 6 years old, 3 of them came with chief complain fever more than 7 days, diagnosis of MIS-C confirmed by antibody IgG SARS-COV2 positive, while the diagnosis of disease when the patient first admitted to the hospital is varied from from polyserositis to severe dengue. All of MIS-C patient discharged with improvement

Conclusions/Learning Points: During pandemic era, careful assessment to diagnosis a disease should not include possibility of COVID-19, especially MIS-C in pediatric patient that has clinical manifestation that fulfill criteria, serology examination for SARS COV-2 should be considered

EP388 / #1878

Topic: AS13. COVID 19 and MIS-C

OUTCOME OF MULTISYSTEM INFLAMMATORY SYNDROME IN IRANIAN CHILDREN

E-Posters

E-POSTER VIEWING

Mohammad Hassan Aelami

Akbar Pediatric Hospital, Mashhad University of Medical Sciences, Infectious Diseases, Mashhad, Iran

Backgrounds: Multisystemic inflammatory syndrome is an inflammatory condition related to COVID-19 infection. The aim of the study was to characterize outcome of Multisystemic inflammatory syndrome (MIS-C) in Iranian children.

Methods:: During a period from August 2020 till November 2021, children admitted in Akbar Pediatric Hospital in Mashhad- Iran with final diagnosis of MIS-C entered our study. Demographic, clinical and laboratory findings were obtained from files and the children were followed in private clinic for 3 months for outcome. Data were analyzed using SPSS software 2016.

Results: Twenty-four children aged 6 months to 11 years were admitted. There are 15 boys (62.5%) and 9 girls (37.5%). Fifteen patients (62.5%) presented as Kawasaki- like disease with conjunctivitis and rash. Most of these children aged less than five years p value<0.05. Severity of MIS-C was mild in 4, moderate in 15 and severe in 5 of our patients. All patients survived. During 3 months follow up, three children had significant cardiac problems and one developed diabetes mellitus.

Conclusions/Learning Points: Children with MIS-C should be followed up for at least three months for complications.

EP389 / #1017

Topic: AS13. COVID 19 and MIS-C

ASSESSMENT OF COVID -19 IMPACT ON STATUS OF ROUTINE IMMUNIZATION IN UNDER-5 CHILDREN:EVIDENCE FROM AN INFANT WELFARE CLINIC IN SOUTH WEST NIGERIA

E-Posters

E-POSTER VIEWING

Olajumoke Aladenola

HOSPITALS MANAGEMENT BOARD, Planning Research & Statistics, AKURE, Nigeria

Backgrounds: CARERS OF UNDER-5 CHILDREN VISIT HEALTH FACILITIES IN NIGERIA TO ACCESS VACCINES AS THE MAIN HEALTH COMMODITY FOR THEIR CHILDREN. THIS IS DUE TO THE INCREASE IN ACCEPTANCE OF IMMUNISATION WITHIN THE LAST FIVE YEARS WITH SIGNIFICANT REDUCTION IN VACCINE HESITANCY. THE OUTBREAK OF COVID-19 HAVE HOWEVER LED TO MIXED REACTIONS FROM CARERS DUE TO THE UNCOORDINATED OFFICIAL RESPONSE TO THE OUTBREAK. THE INITIAL POLICY WHICH LIMITED CITIZENS MOVEMENT MADE IT DIFFICULT FOR CARERS TO ACCESS IMMUNIZATION FOR THEIR CHILDREN. THIS POLICY HOWEVER BECAME RELAXED WITH TIME. THIS STUDY THEREFORE DETERMINES THE STATUS OF UNDER-5 IMMUNISATION FROM JANUARY 2019 TO DECEMBER 2021 AND IMPACT OF THE COVID-19 OUTBREAK ON IT

Methods: THE NUMBER OF CHILDREN ASSESSING 18 DIFFERENT VACCINES CONSISTING OF HPB,HPV0, BCG,HPV1, PENTA1, PCV1, OPV2, PENTA2, PCV2, OPV3, PENTA3, PCV3,IPV, VIT A, MEASLES 1, YELLOW F, MEN A, AND MEASLES 2 OVER A PERIOD OF 36 MONTHS FROM JANUARY 2019 TO DECEMBER 2021 WERE COLLATED. THE DATA COLLECTED WAS SUBJECTED TO STATSTICAL ANALYSIS TO DETERMINE WHETHER THERE WAS ANY SIGNIFICANT REDUCTION IN NUMBER OF CHILDREN ATTENDING CLINIC FOR ROUTINE IMMUNISATION BEFORE (Q1 TO Q5), DURING FIRST AND SECOND WAVES(Q6-Q9) AND DURING THE THIRD WAVE (Q10-Q12)

Results: The study reveals that there was a progressive increase from 2019 to 2021 in the rate of uptake of vaccines. The fear of their children falling ill due to a strange disease was a major cue-to-action for carers.

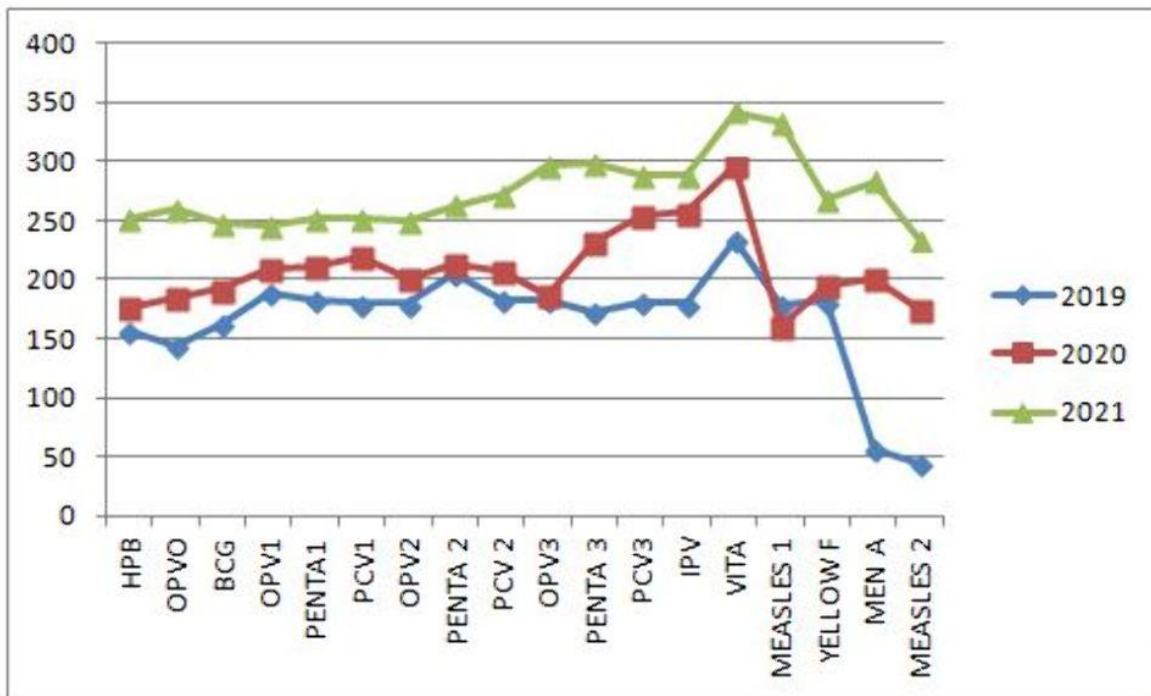

Conclusions/Learning Points: THIS STUDY SHOWS THAT OUTBREAK OF COVID-19 DID NOT HAVE ANY SIGNIFICANT NEGATIVE EFFECT ON CONTINUOUS UPTAKE OF ROUTINE IMMUNISATION BY UNDER-5 CHILDREN. THE CUE -FOR-ACTION FOR THE CARERS WHICH SUSTAINED THIS POSITIVE BEHAVIOUR SHOULD BE DETERMINED FOR APPLICATION FOR MANAGEMENT OF HESITANCY AND REJECTION OF COVID-19 VACCINES

EP391 / #777

Topic: AS13. COVID 19 and MIS-C

PARENTAL PERCEPTIONS OF HEALTHCARE QUALITY AND DEVELOPMENT OF CHILDREN ONE YEAR AFTER THE START OF COVID-19 PANDEMIC

E-Posters

E-POSTER VIEWING

Susana Alexandre¹, Raquel Carreira¹, Rute Afonso², Joana Ferreira², Inês Costa², Ana Gomes², Maria Barroso², Sara Santos¹, Maria Santos²

¹Centro Hospitalar do Oeste, E.P.E. - Unidade de Caldas da Rainha, Paediatric Unit, Caldas da Rainha, Portugal, ²Unidade de Saúde Familiar Arandis - Agrupamento de Centros de Saúde Oeste Sul, Primary Health Care Unit, Torres Vedras, Portugal

Backgrounds: Despite the severity of SARS-CoV-2 infection (COVID19) being mild in children, public health measures have had an impact on the pattern of use of health resources. The aim of this study was to describe parents' opinion about the impact on healthcare quality and in the development of their children, to mitigation strategies.

Methods: Cross-sectional study of a cohort of children under 11 years registered in our primary health care unit in early 2021. The data was collected through an online questionnaire (answered by the parents).

Results: Of a population of 1626 children, we included 170 in the study (95% confidence level, 7% margin of error). Parents stated that 28% of childcare appointments and 12% of health programme vaccines were not carried out as planned, finding more difficult to schedule by 46% of them. According to 40% of parents, the pandemic influenced their child's health and well-being, mainly in social interaction (66%) and mental health (18%). From the 55 children who became ill during the pandemic (32%), about a quarter of parents felt that the pandemic influenced their approach. Regarding transmission of COVID-19, 56% of parents considered the hospital as unsafe or very unsafe, 30% the pre-primary/school and 19% the primary health care unit, with many (31%) delaying the entry of their child in a educational establishment.

Conclusions/Learning Points: More than one year after the beginning of the pandemic, there is still an important negative impact in the healthcare quality. Parents report worst accessibility in primary health care units, fear that their child contracts COVID-19 and insecurity when accessing health services. Their child's healthy development also worries these parents, with the social domain being pointed out as being the most affected.

EP392 / #752

Topic: AS13. COVID 19 and MIS-C

WILLINGNESS TO ACCEPT COVID-19 VACCINE AMONG HEALTHCARE WORKERS IN A TERTIARY HOSPITAL IN NORTH-WESTERN NIGERIA.

E-Posters

E-POSTER VIEWING

Mamman Aliyu Na'Uzo¹, Ben Onankpa², Zainab Abdullahi³, Usman Nasir Nakakana⁴, Bola Lawal Biliaminu⁵

¹Federal Medical centre, Paediatrics, Brinin Kebbi, Nigeria, ²Usmanu Danfodiyo University Teaching Hospital(UDUTH), Sokoto, Paediatrics, Sokoto, Nigeria, ³Usmanu Danfodiyo University Teaching Hospital, Department Of Community Health, Sokoto, Nigeria, ⁴GSK Vaccines Institute of Global Health, Clinical Development And Regulatory Affairs, Siena, Italy, ⁵Nigeria Centre for Disease Control, Epidemiology And Surveillance, Abuja, Nigeria

Backgrounds: COVID-19 vaccine hesitancy has remained a global challenge. Many individuals still have reservations about the safety, efficacy and confidence in the vaccine. Health care workers (HCWs) serve as a window for reliable health information for the patient. Their willingness or otherwise to take the vaccine ultimately affect the uptake of the vaccine among the general population.

Methods: We conducted a cross-sectional study among HCWs during the COVID-19 vaccination sensitization meeting in a tertiary health centre, in northern Nigeria. A self-administered questionnaire was randomly administered among the HCWs. Information obtained were socio-demographics, presence/absence of a chronic condition, years of practice, and willingness of the individual to be vaccinated. The level of statistical significance was set at a p-value of <0.05

Results: Of the 70 questionnaires distributed, 57 responded, the median age = 40yrs (IQR: 35-45), 32 (56.1%) were males, 25 (43.9%) were nurses, 11(19.3%) were doctors. 54 (94.8%) of them had tertiary education with median years of practice of 10yrs (IQR 6-15yrs). Eight (14.1%) have either hypertension, Diabetes or Asthma. 30 (52.6%) were willing to take the vaccine. Among all the respondents, religion was not a barrier to uptake. 51(89.5%) agree to having concerns about the side effect and safety of the vaccine, while 45 (78.9%) have concerns about the efficacy of the vaccine. Among the variables: Age, gender, religion, ethnicity and cadre, only gender had a statistically significant association with willingness to be vaccinated ($\chi^2 = 4.962$, $p = 0.026$)

Conclusions/Learning Points: 53% of the respondents were willing to take the vaccine. Respondents have concerns about safety, side effects and efficacy. Gender was associated with the uptake of the vaccine. We recommend sensitization of health workers on COVID-19 vaccines

EP393 / #1166

Topic: AS13. COVID 19 and MIS-C

COVID-19 INFECTION IN SPINAL MUSCULAR ATROPHY: A SINGLE CENTRE EXPERIENCE

E-Posters

E-POSTER VIEWING

Maria Angeli, Pelagia Vorgia, Maria Bitsori, Glykeria Rouva, Eleni Vergadi, Emmanouil Galanakis
Heraklion University Hospital, Paediatrics, Heraklion, Greece

Title of Case: COVID-19 Infection in Spinal Muscular Atrophy: A SINGLE CENTRE EXPERIENCE

Background: Although COVID-19 has been associated with significant morbidity and mortality in adults, children appear to be less frequently and less severely affected. Nevertheless patients with spinal muscular atrophy (SMA), being particularly vulnerable to respiratory infections, have been assumed to be more susceptible to severe manifestations of COVID-19 and poor clinical outcomes. The aim of this study was to report our center's experience with SMA patients during COVID-19 pandemic era.

Case Presentation Summary: All patients with SMA managed in our department during 2019-2021 were reviewed. Extracted data included SMA type, current disease severity and therapy administered, SARS-CoV-2 vaccination status and disease history and course. A total of five children aged 11-15 years were reviewed. All patients were diagnosed with SMA Type II and were treated with Nusinersen every four months and two of them were vaccinated against SARS-CoV-2 without adverse events. One patient had tracheostoma and gastric feeding tube and one patient had noninvasive ventilation during sleep. Only two patients, monozygotic male twins, were tested positive for SARS-CoV-2 after exposure to their positive older sister. They received colchicine daily for Familial Mediterranean fever. Both patients developed mild symptoms with low-grade fever, dry cough and additionally gastrointestinal symptoms for the second twin. Neither patient experienced breathing difficulties nor required supplemental oxygen or hospitalization.

Learning Points/Discussion: There are several cases of SMA and COVID-19 reported in the literature, including our center's experience, without serious respiratory manifestations suggesting that the disease course may not be as severe as expected. Hospitalization for regular therapy administration appears to be safe and should be conducted as planned, since current available therapies combined with the young age may play a protective role against severe disease.

EP394 / #1276

Topic: AS13. COVID 19 and MIS-C

CLINICAL SPECTRUM OF SARS-COV-2 INFECTION ACCORDING TO VARIANT IN INFANTS YOUNGER THAN 3 MONTHS

E-Posters

E-POSTER VIEWING

Michaël Levy¹, Naim Ouldali², Pierre Mornand³, Paul Casha⁴, Fouad Madhi⁵, Alexis Rybak², Robert Cohen², Vincent Gajdos⁶, Camille Aupiais⁷, Manon Passard⁸, Noémie Vanel⁹, Irina Craiu¹⁰, Corinne Levy², [Francois Angoulvant](#)¹¹

¹Robert Debré Hospital, Pediatric Intensive Care Unit, Paris, France, ²ACTIV, Paediatrics, Créteil, France, ³CH Annecy, Pediatric Department, Annecy, France, ⁴CH de Toulon, Pediatric Department, Toulon, France, ⁵CHI de Creteil, Pediatric Department, Créteil, France, ⁶Hôpital antoine Béclère, Pediatric Department, Clamart, France, ⁷Hopital Jean Verdier, Paediatrics, Bondy, France, ⁸Hopital Femme Mère Enfant, Pediatric Department, Bron, France, ⁹CHU de la Timone, Pediatric Intensive Care Unit, Marseille, France, ¹⁰Hôpital Universitaire Bicêtre, APHP, Pediatric Emergency, Kremlin-Bicêtre, France, ¹¹Hopital universitaire Robert Debré, Pediatric Infectious Diseases And Internal Medicine, Paris, France

Backgrounds: Since the beginning avec the SARS-CoV-2 pandemic, several variants have been identified. To date, the clinical impact of each variant on children remains poorly known. The aim of this study was to analyze the clinical spectrum of SARS-CoV-2 infection in infants younger than 3 months of age depending on the variant.

Methods: Using a national prospective surveillance from February 15, 2020 to December 21, 2021, 66 French pediatric departments enrolled children hospitalized with SARS-CoV-2 infection and/or or Multisystem Inflammatory Syndrome in Children (MIS-C). Three periods were defined according to the predominant variant: 20E variant before 01/03/2021, Alpha variant from 01/03/2021 to 28/06/2021, and Delta variant from 28/06/2021 to 21/12/2021.

Results: Among the 1292 hospitalized children with SARS-CoV-2 infection, 416 (32%) were younger than 3 months. Overall, 273 (66%) were included in the 20E period, 55 (13%) in the Alpha period, and 88 (21%) in the Delta period. No death was recorded. Delta variant COVID-19 were more often symptomatic.

| Characteristics | Periods 20E variant N=273 | Alpha variant N=55 | Delta variant N=88 |
|-------------------------------|---------------------------------|-----------------------|-----------------------|
| Female | 108 (40%) | 24 (44%) | 42 (49%) |
| Comorbidities | 13 (5%) | 0 (0%) | 3 (3%) |
| Diagnostic | | | |
| Pauci-symptomatic COVID-19 | 164 (60%) | 31 (56%) | 35 (40%) |
| Symptomatic COVID-19 | 83 (30%) | 20 (36%) | 48 (55%) |
| MIS-C | 2 (1%) | 0 (0%) | 4 (5%) |
| Incidental COVID-19 diagnosis | 24 (9%) | 4 (7%) | 1 (1%) |
| Hospital treatment* | 72 (26%) | 19 (35%) | 27 (31%) |
| PICU admission | 14 (5%) | 3 (6%) | 11 (13%) |
| Length of stay, median | 2 (1-4) | 2 (1-4) | 2 (1-3) |

*hospital treatment includes O₂ therapy and/or enteral feeding, and/or intravenous hydration, and/or nebulized therapy.

Conclusions/Learning Points: In this large cohort of infant under three months hospitalized for SARS-CoV-2 infection, clinical forms were mild whatever the variant involved.

EP395 / #1048

Topic: AS13. COVID 19 and MIS-C

MULTISYSTEM INFLAMMATORY SYNDROME (MIS-C) PRESENTING AS RETROPHARYNGEAL ABSCESS IN A 10-YEAR OLD BOY

E-Posters

E-POSTER VIEWING

Eleni Tasika, Petrina Vantsi, [Charalampos Antachopoulos](#), Emmanuel Roilides
Hippokraton Hospital, 3rd Dept Of Pediatrics, Aristotle University, Thessaloniki, Greece

Title of Case: MULTISYSTEM INFLAMMATORY SYNDROME (MIS-C) PRESENTING AS RETROPHARYNGEAL ABSCESS IN A 10-YEAR OLD BOY

Background: The multisystem inflammatory syndrome (MIS-C) associated with SARS-CoV-2 infection has various clinical presentations which are not yet fully characterized. We present a case of MIS-C in a pediatric patient initially presenting as retropharyngeal abscess.

Case Presentation Summary: A 10-year old boy was admitted with fever, sore throat, fatigue and reduced oral intake. He had mildly enlarged bilateral cervical lymph nodes, painful limitation of lateral head movements, moderate leukocytosis and increased C-reactive protein (CRP) value (99 mg/L). A cervical CT scan revealed widening of the pre-vertebral soft tissue (up to 9 mm, extending over a length of 8.5 cm in the retropharyngeal space), consistent with retropharyngeal edema/inflammation. He was started on intravenous amoxicillin-clavulanic acid plus metronidazole. Fever persisted and 2 days afterwards he had vomiting, diarrhea, abdominal and chest pain, hypotension, tachycardia and 1st degree atrio-ventricular block on ECG. A maculopapular rash was noted, together with erythema and increased size of right cervical lymph nodes. There was further increase of CRP (230 mg/L), mild increase of serum troponin and thrombocytopenia. The patient had a history of SARS-CoV-2 infection one month ago confirmed with rapid antigen test, and positive serology for SARS-CoV-2. MIS-C was diagnosed, for which he received IVIG (2 g/kg), methylprednisolone (60 mg/day) and low-dose aspirin (100 mg/day). There was good response, and repeated cervical CT 5 days later showed almost complete resolution of the retropharyngeal inflammation. Antibiotics were discontinued.

Learning Points/Discussion: MIS-C may occasionally present as retropharyngeal inflammation in young children. While antimicrobial treatment should not be withheld, close patient monitoring may reveal additional clinical and laboratory signs of this new syndrome, allowing timely diagnosis and appropriate treatment.

EP396 / #1603

Topic: AS13. COVID 19 and MIS-C

CHANGE OF INCIDENCE OF COVID-19 VARIANTS ACCORDING TO AGE GROUPS DURING THE THIRD PEAK OF PANDEMIA

E-Posters

E-POSTER VIEWING

Kamile Arıkan

Izmir Buca Research Hospital, Pediatric Infectious Disease, Izmir, Turkey

Backgrounds: The severe acute respiratory syndrome coronavirus 2 (SARS-CoV-2) has resulted in a pandemic with more than 9 million infections of coronavirus disease 2019 (COVID-19) since the first reported cases in December 2019. We aimed to explore COVID variants according to age groups during the third peak of pandemic.

Methods: Patients with COVID -19 infection during March-July 2021 were evaluated .Sociodemographic variables and isolated COVID-19 variants were recorded.

Results: With a mean age of 38 ± 15.1 yaş (1 day-90 years), 688 (43.7%) male, totally 1575 patients were included in the study. Of the mutant isolates, 554 (5.2%) were B.1.1.7 (Alpha) variant, 39 (2.5%) were E484K mutant, 14 (0.9%) were South Afrikan-brazilian variant , 6 (0.4%) delta variant.Ot the total COVID-19 isolates 950 (60.3%) were non-mutant. B.1.1.7 (Alpha) variant was isolated statistically more common in 18-50 years old of age during the days of school-closure. There was no difference according to gender and mutant types. E484K mutant was ore common in 18-30 years old of age.Delta variant, which is the dominnat type nowadys was found to be first appeared after June 2021.

Conclusions/Learning Points: İsolation during pandemic resulted in fever mutant variant isolation especially in children and elderly. B.1.1.7 (Alpha) variant and E484 K mutation were found to be factors increasing transmission.

EP397 / #749

Topic: AS13. COVID 19 and MIS-C

RECOMBINANT HUMAN SURFACTANT PROTEIN D (RHSP-D) REDUCES VIRAL LOAD AND ATTENUATES LUNG INJURY INDUCED BY SARS-COV-2 IN COVID-19

E-Posters

E-POSTER VIEWING

Raquel Arroyo, Shawn Grant, Michael Depietro, Marc Salzberg
Airway Therapeutics Inc, Research And Development, Atlanta, United States of America

Backgrounds: COVID-19 is a common problem in the pediatric population nowadays, and in vulnerable populations can lead to hospitalization and even life-threatening illness. While a vaccine is available, breakthrough cases and incomplete uptake have contributed to continued infections. Current anti-viral therapies for SARS-CoV-2 have limitations and new treatments are needed. Surfactant protein D (SP-D) is an immune collectin protein naturally found in human lungs. It has been published that SP-D and its recombinant version (rhSP-D) recognizes and binds to SARS-CoV-2, SP-D inhibits SARS-CoV-2 cell entry and severe adult COVID-19 patients exhibit very low BALF SP-D levels. It is also known that SP-D inhibits the pro-inflammatory response interacting with specific receptors on inflammatory cells. We hypothesize that rhSP-D might reduce viral load attenuating the lung inflammation and injury induced by SARS-CoV-2.

Methods: Experiments were performed using an in-vivo hamster model for SARS-CoV-2 infection. Intranasal or intratracheal rhSP-D were administered at a dose range 2-8 mg/Kg. Body weight and viral titers in lung were measured and histopathology analysis was performed.

Results: Intratracheal administration of rhSP-D at 2&6 mg/kg showed a significant reduction of SARS-CoV-2 titers in lungs 48h post-infection compared to placebo; 96h post-infection, a reduction in viral titers was still observed with administration of 4 mg/kg of rhSP-D. No differences were found in the body weight between experimental groups over time. Using a different delivery route, intranasal rhSP-D at a dose range 2-8 mg/kg attenuated the epithelial injury with cell death, bronchiolitis, alveolitis and inflammation in lungs at day 2 and 7 post-SARS-CoV-2 infection, which was assessed by microscopic analysis of lung histopathology.

Conclusions/Learning Points: We conclude that rhSP-D reduces SARS-CoV-2 load in lungs in-vivo and it might attenuate lung inflammation and injury induced by SARS-CoV-2.

EP399 / #1545

Topic: AS13. COVID 19 and MIS-C

CLINICAL CHARACTERIZATION OF COVID-19 IN PEDIATRIC POPULATION: A 1-YEAR STUDY

E-Posters

E-POSTER VIEWING

André Assunção¹, Carolina Faria², Ana Reis E Melo^{2,3}, Margarida Tavares²

¹Centro Hospitalar Universitário São João, Paediatrics Infectious Diseases And Immunodeficiencies, Porto, Portugal, ²Centro Hospitalar Universitário de São João, Paediatrics Infectious Diseases And Immunodeficiencies, Porto, Portugal, ³Centro Hospitalar de São João, Pediatrics, porto, Portugal

Title of Case: COVID-19 IN PEDIATRIC POPULATION

Background: SARS-CoV-2 had a smaller impact compared than expected in such a heterogeneous group as the pediatric population. Therefore, we designed a 1-year retrospective study (from March 1st 2020 to March 31st 2021) to characterize the impact of COVID-19 in pediatric population with a positive SARS-CoV-2 PCR-test, at a level 3 hospital, as well as attempted to infer the transmission pattern (in a subgroup followed until cured). We also compared the 3 waves that occurred.

Case Presentation Summary: During this period, 766 children and teenagers were diagnosed with SARS-CoV-2 infection. Median age was 8 yr., 1% was high-risk group, 95% were symptomatic with a median disease duration of 2 days and epidemiological link in 67%. Most common symptoms were upper respiratory (60%), fever (50%), headache (30%), chest pain or dyspnea (19%). Fever was more prevalent in infants while headache, anosmia and dysgeusia in teenagers. In this period only 33 were admitted to hospital (11 with acute COVID-19, 3 of which were immunocompromised, and 2 due to PIMS-TS); all had good outcome without need for respiratory or pharmacological support. Out of 766, 153 had a follow-up until considered cured (for the standards at the time): median age 8 yr.; apparent epidemiological link in 85%; median duration of disease of 8 days; the transmission from adult to children did not seem to be relevant in this subgroup. The 3 waves at their peak had a positive/tested ratio of 45/451 (1st wave), 81/696 (2nd wave) and 33/528 (3rd wave), with 3, 19 and 7 cases admitted to hospital, respectively.

Learning Points/Discussion: We concluded that COVID-19 was clinically mild in all age groups, there was little need of hospitalization and the evolution seems to be good.

Topic: AS13. COVID 19 and MIS-C

SARS-COV-2 SEROPREVALENCE AMONG SCHOOLCHILDREN IN ITALY DURING THEOMICRON PREDOMINANT PERIOD

E-Posters

E-POSTER VIEWING

Lucia Barcellini¹, Alessandra Mari¹, Niccolò Garancini¹, Luisella Alberti², Paola Gaia², Laura Folgori¹, Gian Vincenzo Zuccotti³

¹Ospedale dei Bambini V. Buzzi, Department Of Paediatrics, Milan, Italy, ²Ospedale dei Bambini V. Buzzi, Newborn Screening Laboratory, Regional Reference Center For Metabolic Screening,, Milan, Italy, ³Università degli studi di Milano, Department Of Pediatrics, V. Buzzi Children's Hospital, Department Of Biomedical And Clinical Sciences "I. Sacco" And Pediatric Clinical Research Center "romeo Ed Enrica Invernizzi", Milan, Italy

Backgrounds: We aimed to estimate the SARS-CoV-2 seroprevalence among children during the omicron predominant period and to compare these to results previously reported by our group after the first and second pandemic waves.

Methods:: A cross-sectional SARS-CoV-2 serologic testing program using dried blood spots was implemented across 11 pre-schools and primary schools in Milan, in February 2022. Filter papers were tested by automated GSP®/DELFIA® anti SARS-CoV2 kit (PerkinElmer).

Results: A total of 687 pupils were included. Demographic characteristics in table 1. For 20 (2,9%) participants the blood sample was insufficient to perform analyses. Of the 667 valid tests, 514 were performed among not-vaccinated children, 42 received 1 dose, 104 were fully vaccinated. Among not-vaccinated participants 36 were borderlines (0.9-1.19) and 232 were positive (≥ 1.20), corresponding to a seroprevalence for positive of 52,1% (95% CI, 0.48-0.56%). Considering the quantitative data, the overall SARS-CoV-2 IgG values among fully vaccinated pupils (104) was higher than in not-vaccinated participants reporting a previous infection (136) (median 56.8 vs 6.9 respectively; T-test $p=0.0001$).

| | Total N=667 | | Pre-schools N=132 | | Primary- schools N=532 | |
|-------------------------|----------------|-----|----------------------|-----|------------------------------|-----|
| Male | 343 | 51% | 68 | 52% | 275 | 52% |
| Not-vaccinated | 514 | 77% | 132 | | 386 | 73% |
| Fully Vaccinated | 104 | 16% | 0 | 0% | 102 | 19% |
| Previous infection | 183 | 27% | 26 | 20% | 157 | 30% |
| SAR-CoV-2 serology | | | | | | |
| Negative | 252 | 38% | 62 | 47% | 189 | 36% |
| Borderline and Positive | 414 | 62% | 70 | 53% | 343 | 64% |

Conclusions/Learning Points: We found a SARS-CoV-2 seroprevalence among schoolchildren in Milan during the omicron predominant period of 52,1%, indicating a five-fold increase when compared to data collected by our group in September 2020 (2.8% 95% CI, 1.9–3.9%) and in February 2021 (12,5%; 95% CI, 10.6–14.6%). Moreover, quantitative data of SARS-CoV-2 IgG response among fully-vaccinated children show a strong IG response, higher than in those previously infected.

EP402 / #63

Topic: AS13. COVID 19 and MIS-C

THE OUTCOME OF PATIENTS WITH SEVERE COVID-19 PNEUMONIA TREATED WITH DEXAMETHASONE VS. METHYLPREDNISOLONE: A RETROSPECTIVE COHORT STUDY

E-Posters

E-POSTER VIEWING

Jamil Bhatti¹, Syed Raza¹, Imtiaz Begum¹, Irshad Batool², Misha Aftab¹, Armeena Anis¹

¹Dr. Ziauddin Hospital, Medicine, Karachi, Pakistan, ²Isra University Hospital, Gastroenterology, Hyderabad, Pakistan

Backgrounds: Coronavirus disease 19 (COVID-19) induces lung injury, progressing to acute respiratory distress syndrome (ARDS). Several treatment options were tried across the world, including corticosteroids that showed beneficial outcomes. However, the most suitable corticosteroid type and dose in the treatment of COVID-19 remain undefined. Therefore, we conducted a study to compare the efficacy of dexamethasone and methylprednisolone in treating severe COVID-19 pneumonia.

Methods: This retrospective, comparative cohort study with survival analysis included 1001 patients diagnosed with severe COVID-19 pneumonia admitted to a tertiary care hospital, Dr. Ziauddin Hospital North Nazimabad, Karachi, Pakistan, from April 2020 through February 2021.

Results: No significant difference was found in the mortality between study groups. A significantly higher percentage of patients in the MTP group required ICU admission (194 (33.0%) vs. 89 (21.5%); $P < 0.001$). Patients in the DXM group had significantly lower odds of ICU admission (OR: 0.419, 95% CI: 0.273-0.642; $P < 0.001$), supported by a significantly lower risk of the need for ICU admission (HR 0.538, 95% CI: 0.383-0.755; $P < 0.001$). However, on Kaplan-Meier analysis, patients in the DXM group were discharged significantly earlier (6.83 vs. 8.20 days; Log Rank $P = 0.003$) and required ICU admission much later (5.01 vs. 2.40 days; Log Rank $P < 0.001$).

Conclusions/Learning Points: Dexamethasone was found to have a significant reduction in the need for intensive care unit admission and early hospital discharge.

EP403 / #597

Topic: AS13. COVID 19 and MIS-C

CHARACTERISTICS OF CHILDREN WITH MULTISYSTEM INFLAMMATORY SYNDROME IN CHILDREN RELATED TO SARS-COV-2 FROM BRASOV AREA, ROMANIA

E-Posters

E-POSTER VIEWING

Bettina-Lavinia Boeriu¹, Maria Terciu¹, Codruța Țăposu¹, Luciana Petrescu¹, Maria Mitrica^{1,2}, Laura Dracea^{1,2}, Claudia Voina¹, Popa Corina¹, Bianca Popovici^{1,2}, Emanuela Cojocaru¹, Katalin Csutak¹, Anca Ilea^{1,2}, Oana Falup-Pecurariu^{1,2}

¹Children's Clinic Hospital, Paediatrics, Braşov, Romania, ²Transilvania University, Faculty Of Medicine, Brasov, Romania

Backgrounds: Although data on the incidence and severity of COVID-19 due to SARS-CoV-2 infection showed more significant disease among adults and the elderly, a clinical manifestation characterized by a multisystem inflammatory syndrome was described in children (MIS-C).

Methods: A retrospective study was conducted between October 2020 and November 2021 and included all children who were diagnosed with MIS-C. Inclusion criteria: young age, severe cardiovascular or multisystem clinical manifestations, laboratory evidence of inflammation; and laboratory evidence of SARS-CoV-2 infection. A number of 22 children aged 25 days to 15 years were enrolled.

Results: Although the first MIS-C cases were reported from London in late April 2020, the first MIS-C case in Braşov was reported almost 6 months later, in October 2020. The majority of cases were reported during 2021 (20 cases). 54% were girls, 63% came from urban area, mean age was 5 years, most patients were younger than 6 years old (72%). Mean hospital stay was 10.3 days. Most frequent symptoms were: prolonged fever and gastro-intestinal manifestations (85%), common symptoms were sore throat (68%), mucosal manifestations and lymphadenopathies (54%), rash (50%). Other symptoms were respiratory manifestations (41%) and edema (23%). Laboratory findings were: normal peripheral white blood cells in 72% of patients, decreased lymphocytes in 40%, mean CRP was 14 mg/dl, mean ESR was 77mm/h, mean Fibrinogen was 557mg/dl, mean Albumin was 3mg/dl, high Ferritin values were found in 63%, high D-Dimers in 81%, high Pro-Bnp in 86% and high Troponin levels in 27% of children. Corticotherapy was used in 21 cases, intravenous immunoglobulin in 20, Aspirin in 10 and low molecular weight heparin in 7 patients. Antibiotics were administered in all children.

Conclusions/Learning Points: It is important to increase awareness of physicians about MIS-C.

EP404 / #1369

Topic: AS13. COVID 19 and MIS-C

POLYNEUROPATHY ASSOCIATED WITH COVID-19 IN A CHILD: CASE REPORT

E-Posters

E-POSTER VIEWING

Oksana Boyarchuk¹, Diana Savkiv¹, Oksana Skovronska²

¹I.Horbachevsky Ternopil National Medical University, Department Of Children's Diseases And Pediatric Surgery, Ternopil, Ukraine, ²Ternopil Regional Children Hospital, Neurology Department, Ternopil, Ukraine

Title of Case: Polyneuropathy associated with COVID-19 in a child: case report

Background: Neurological manifestations associated with SARS-CoV-2 infection are well known in adult population. In pediatric patients neurologic complications are reported mainly in association with multisystem inflammatory syndrome.

Case Presentation Summary: A 12-year-old girl was admitted to the hospital with progressive weakness of lower limbs, gait disorders, joint and muscle pain. Two weeks before the girls had mild manifestations of respiratory disease. Neurological examination revealed decreased knee, Achilles and plantar reflexes. Hypoesthesia was also observed. Complete blood count revealed leukocytosis (23,810/ μ L), neutrophilia (20,468/ μ L) and moderate thrombocytopenia (109/ μ L). CRP was normal and ANA titer was 1: 320 (reference range <1: 100). Electromyography and nerve conduction study confirmed diagnosis of polyneuropathy. IgG antibodies to SARS-CoV-2 were elevated. Instead, the results of tests for IgM antibodies to other viruses (CMV, HSV, EBV), as well as the detection of poliovirus in the feces were negative. Ultrasound of the knee joints showed signs of bursitis on both sides and synovitis on the left. In addition, the girl presented with anxiety, depression and eating disorders. Patient received intravenous pulses of methylprednisolone and two cycles of IVIG with marked improvement.

Learning Points/Discussion: Neuropathies along with other neurological manifestations may follow even mild course of SARS-CoV-2 infection in children.

EP405 / #394

Topic: AS13. COVID 19 and MIS-C

POST-COVID CONDITION IN ADULTS AND CHILDREN LIVING IN THE SAME HOUSEHOLD IN ITALY: A PROSPECTIVE COHORT STUDY USING THE ISARIC GLOBAL FOLLOW-UP PROTOCOL

E-Posters

E-POSTER VIEWING

Danilo Buonsenso¹, Piero Valentini²

¹Fondazione Policlinico Universitario A. Gemelli IRCCS, Pediatrics, Roma, Italy, ²Gemelli, Pediatrics, rome, Italy

Backgrounds: Emerging evidence shows that both adults and children may develop post-acute sequelae of SARS-CoV-2 infection (PASC). The aim of this study is to characterise and compare long-term post-SARS-CoV-2 infection outcomes in adults and children in a defined region in Italy

Methods: Prospective cohort study including children (≤ 18 years old) with PCR-confirmed SARS-CoV-2 infection and their household members. Participants were assessed via telephone and face-to-face visits up to 12 months post-SARS-CoV-2 diagnosis of household index case, using the ISARIC Covid-19 follow-up survey.

Results: 56.4% (286/507) were children, 43.6% (221/507) adults. SARS-CoV-2 positivity was 87% in children, and 78% in adults. The mean age of PCR positive children was 10.4 (SD 4.5) and of PCR positive adults was 44.5 years (SD 9.5), similar to the PCR negative control groups (children 10.5 years (SD 3.24), adults 42.3 years (SD 9.06)). Median follow-up was 77days (IQR 47–169). A higher proportion of adults compared to children reported at least one persistent symptom (67%, 68/101 vs 32%, 57/ 179, $p < 0.001$) at the first follow up. Adults had more frequently coexistence of several symptom categories at both follow-up time-points. Female gender was identified as a risk factor for PASC in adults, but not in children. We found no significant correlation between adults and children symptoms. In the pediatric group, at 1-3 months follow-up positive children had more frequently persisting symptoms, but not at 6-9 months.

Conclusions/Learning Points: Our data highlights that children can experience persistent multisystemic symptoms months after diagnosis of mild acute SARS-CoV-2 infection, although less frequently and less severely than co-habitant adults. There was no correlation between symptoms experienced by adults and children living in the same household.

Topic: AS13. COVID 19 and MIS-C

STUDY OF PREVALENCE AND CHARACTERISTICS OF LONG COVID IN SPANISH CHILDREN.

E-Posters

E-POSTER VIEWING

Elena Sánchez Marcos¹, María Bergia², Blanca González Haba³, Ana Herraiz⁴, Maria De Ceano Vivas², Milagros García-López Hortelano², M^a Luz García García⁵, Raquel Jiménez García¹, [Cristina Calvo²](#)

¹Hospital Infantil Niño Jesús, Pediatrics, Madrid, Spain, ²Hospital La Paz, Pediatric Infectious Diseases, Madrid, Spain, ³Hospital Puerta del Mar, Pediatrics, Cadiz, Spain, ⁴Universidad Alfonso X el sabio, Pediatrics, Madrid, Spain, ⁵Hospital Universitario Severo Ochoa, Pediatrics, Madrid, Spain

Backgrounds: Prolonged symptoms after acute COVID-19 have been described in the pediatric population. Our objective was to know the prevalence of prolonged symptoms in children with confirmed SARS-CoV-2 infection, and to describe their clinical characteristics and possible risk factors.

Methods: Multicentre retrospective study carried by telephone questionnaire of all children under 18 years old diagnosed of symptomatic COVID-19, both hospitalized and outpatient, attended in three hospitals in Spain between March and December 2020. Long-COVID was defined as the presence of symptoms longer than 12 weeks. A control group of children attended by other causes in the same period was also contacted and compared.

Results: 451 children met criteria and agreed to participate; 370/451 (82%) presented mild outpatient infection, and 23 required admission in PICU (5.1%). The mean age was 5.9 years old (SD 5.3). A control group of 98 children was included. In 66 cases (14.6%) at least one symptom lasted longer than 12 weeks. Insomnia, concentration problems, apathy or sadness and anxiety were the longest (median >90 days). Age above 5 years (48/66; 72.7%, OR: 3, CI 95% (1.8-5)); admission (OR 3.9 CI 95% (2.2-6.8)), the need for PICU (OR 4.3 CI 95% (1.8-10.4)), and having a relative with prolonged symptoms (OR 2.8 CI 95% (1.5-5.2)) were significantly associated with Long-COVID. When comparing with controls age above 5 years old, myalgia, asthenia, and loss of appetite were significantly associated with Long-COVID. Surprisingly, when analyzing patients in control group, proportions of prolonged symptoms observed after the acute process that required assistance were similar to children with SARS-CoV-2 infection, mainly affective sphere symptoms in aged above 5 year.

Conclusions/Learning Points: Our study shows that children also suffer prolonged symptoms after COVID-19 infection, and require specific attention.

EP408 / #1416

Topic: AS13. COVID 19 and MIS-C

ACUTE CEREBELLAR ATAXIA IN A PATIENT WITH MAPLE SYRUP URINE DISEASE: A CASE REPORT

E-Posters

E-POSTER VIEWING

Carolina Castro¹, Patrícia Lipari Pinto², Patrícia Janeiro², Sofia Quintas³, Ana Gaspar²

¹Hospital de Santa Maria - Centro Hospitalar Universitário Lisboa Norte, Serviço De Pediatria Médica, Departamento De Pediatria, Lisboa, Portugal, ²Hospital de Santa Maria - Centro Hospitalar Universitário Lisboa Norte, Unidade De Doenças Metabólicas, Departamento De Pediatria, Portugal, ³Hospital de Santa Maria - Centro Hospitalar Universitário Lisboa Norte, Unidade De Neuropediatria, Departamento De Pediatria, Lisboa, Portugal

Title of Case: ACUTE CEREBELLAR ATAXIA IN A PATIENT WITH MSUD

Background: Maple syrup urine disease (MSUD) is an aminoacid catabolism disorder. When concurrent episodes of catabolism occur, patients may present with metabolic intoxication crises with multiple organ manifestations. Viral infections, as COVID-19, may trigger metabolic crises, but can also cause acute or post infectious neurologic symptoms, which can be confounding factors when similar symptoms appear.

Case Presentation Summary: A 6-year-old boy with MSUD presents with fever, cough, and swaying side to side. He tested positive for COVID-19 and was diagnosed with a metabolic crisis (Leucine: 892mM/L). He was admitted to the hospital and interrupted natural protein intake. He progressively recovered and was discharged. After two uneventful weeks he presents with sudden onset ataxia, tremor, dysarthria and was readmitted. A MSUD crisis was excluded when normal aminoacid chromatography results came in and after the interruption of natural protein intake with no clinical improvement. He performed a lumbar puncture (LP) and Magnetic Resonance Imaging (MRI) compatible with the previous MSUD diagnosis, but a demyelinating acute disorder couldn't be ruled out. He was started on methylprednisolone for five days, with no clinical improvement. A second LP and MRI were performed, and the findings remained unchanged. He was then started on Intravenous Immunoglobulin. He was discharged, clinically better, after 14 days.

Learning Points/Discussion: In our patient, initially a MSUD crisis was suspected. Subsequently, both diagnosis of acute post-infectious ataxia and acute disseminated encephalomyelitis were considered. Our patient presented a challenge because of his concurrent metabolic disorder and clinical similarities between MSUD crises and the post-infectious neurologic condition. SARS-CoV-2 infection and post-infectious consequences pose new challenges, particularly in patients with neurologic or metabolic chronic disorders, in which decompensation crises may share symptoms.

Topic: AS13. COVID 19 and MIS-C

IMPACT OF ANTIRETROVIRAL TREATMENT (ART), IMMUNOSUPPRESSION AND CO-MORBIDITIES ON SARS-COV-2 COURSE IN HIV-POSITIVE CHILDREN IN UKRAINE

E-Posters

E-POSTER VIEWING

Vera Chechenyeva^{1,2}, Oksana Soldatenkova², Natalya Ulshina², Oksana Bandura³, Iryna Shkurka⁴, Viktoria Savchenko⁵

¹National Institution of Phthisiology and Pulmonology of National Academy of Medical Sciences of Ukraine in Kiev, Department Of Children Phthisiology, Kyiv, Ukraine, ²National Specialised Children's Hospital "OKHMATDYT", Center For Treatment Children With Hiv/aids, Kyiv, Ukraine, ³KNP Bilotserkivskoy city council, Bilotserkivska City Hospital No. 3, Bila Cercva, Ukraine, ⁴KNP "Chernigivskiy regional medical center of socially significant and dangerous diseases" CHOR Center of fighting with HIV/AIDS, Pediatric, Chernigiv, Ukraine, ⁵KNP "Phthisiopulmonology Medical Center", Knp "phthisiopulmonology Medical Center", Cherson, Ukraine

Backgrounds: Data on severity and mortality among HIV-positive adults with COVID-19 are twofold (1). In some research despite effective ART, HIV infection more than doubled the risk of death from COVID-19 (1, 2). In the other source, higher hospitalization and mortality rates associated with COVID-19 in HIV positive adults were not found (3). In children SARS-COV-2 does not cause as severe morbidity and mortality as it is in adults. However, serious consequence such as paediatric multisystem inflammatory syndrome temporally associated with COVID-19 (PIMS-TS) has been described in children (4,5)

Methods: The study is retrospective, the medical records of HIV-positive children with confirmed SARS-COV-2 positive test during the period from 1st April 2020 to 31 August 2021 were selected in a few HIV clinics in Ukraine.

Results: Among 766 patients, 13 had a confirmed SARS-COV-2 positive test. The patients were divided into 2 groups: symptomatic (SG) and asymptomatic (AG). Data of both groups are presented in the Table 1.

| | SG, N=8 | AG, N=5 |
|---|---------|---------|
| Average age, months | 73 | 98 |
| Average CD4 cells, cells/ml | 1535 | 980 |
| Average CD4 percentage, % | 29 | 24 |
| Average HIV viral load on SARS-COV-2 onset, copies/ml | 581 012 | 418 615 |
| Percentage of patients with the undetectable VL, % | 50 | 40 |
| Patients without ART before SARS-COV-2 case, % | 37 | 0 |
| Mortality on 28 day after positive SARS-COV-2 test, % | 12 | 0 |

Conclusions/Learning Points: PIMS-TS was not developed in either groups. In AG, patients had more co-morbidities, worse adherence to ART (less than half patients had undetectable VL), however, all the patients had a history of ART. At the same time, in SG -37 % patients have not received ART before SARS-COV-2 case. ART may be assumed to contribute to a favorable course of the SARS-COV-2 course.

EP411 / #1926

Topic: AS13. COVID 19 and MIS-C

TWO CASES OF CARDIAC ARRHYTHMIAS AFTER INFECTION WITH THE NOVEL COVID-19 IN PICU

E-Posters

E-POSTER VIEWING

Anastasia Liaskou, Kalliopi Straka, [Eleni Christakou](#)
AGIA SOPHIA CHILDRENS HOSPITAL, Pediatric Intensive Care Unit, Athens, Greece

Title of Case: Two cases of cardiac arrhythmias after infection with the novel COVID-19 in PICU

Background: Patients with COVID-19 present with symptoms and signs of respiratory tract infection. Secondary cardiac disease, including tachyarrhythmias, with or without signs of myocardial injury, have been documented.

Case Presentation Summary: We present 2 paediatric cases of cardiac arrhythmias after COVID-19 infection that were hospitalised in our PICU. Case 1: A previously healthy 5-year old girl was admitted to PICU due to tachyarrhythmia, after being hospitalised in the paediatric ward due to fever and abdominal pain. Upon admission, the patient had HR:150/min, BP:100/70mmHg; Biomarkers revealed NT-proBNP level of 7490 (normal values <300), whereas CK-MB and Troponine were in range. Initial ECG showed supraventricular tachycardia which subsided with antipyretics and intravenous hydration but subsequent studies showed Mobitz type 1 (Weckenbach) second degree AV block, which was not present at the time of admission. NT-proBNP levels decreased until the patient was discharged. The patient remained hemodynamically stable and were discharged to cardiology department for further testing. Case 2: A previously healthy 18-month old boy presented with fever, supraventricular tachycardia (HR:250/min, BP:100/50mmHg) and a history of COVID-19 infection. Upon admission, he received adenosine and amiodarone with poor clinical response and the patient was subsequently sedated and intubated so that cardioversion could be performed. He required 4 rounds of electrical cardioversion. Subsequently, he was transferred to cardiology ward, where he presented with short episodes of supraventricular tachycardia although he was on treatment with amiodarone. He was transferred to a specialized center for further testing and management

Learning Points/Discussion: Most studies show a wide spectrum of cardiac disease after infection with the COVID-19 and not all patients are affected in the same manner. Therefore, cardiac screening tests should be performed in all patients with COVID-19 infection that are hospitalized and clinicians should be aware of the likelihood of myocardial injury and its clinical manifestations.

EP412 / #1929

Topic: AS13. COVID 19 and MIS-C

A RARE CASE OF GUILLAIN-BARRÉ SYNDROME POST COVID-19 INFECTION IN A YOUNG MALE PATIENT.

E-Posters

E-POSTER VIEWING

Kalliopi Straka, Eleni Christakou, Marilena Prapa, Evdoxia Mpourazani, Panagiotis Poulos
AGIA SOPHIA CHILDRENS HOSPITAL, Picu, ATHENS, Greece

Title of Case: A rare case of Guillain-Barré syndrome post COVID-19 infection in a young male patient.

Background: Guillain Barré syndrome (GBS) is an acute inflammatory immune-mediated polyneuropathy characterized by rapidly progressing symmetrical ascending weakness and hypo-or areflexia establishing over days to weeks. It is typically a post-infectious autoimmune process leading to destruction of myelin. COVID-19 seems to act as a trigger; the mechanism of neurological manifestation can be explained by the presence of ACE-2 receptor in nervous system and skeletal muscles.

Case Presentation Summary: We report the case of COVID-19 associated with GBS in a young boy. An 11-year-old boy, with unremarkable past medical history and asymptomatic COVID-19 infection 2 weeks ago, presented to our hospital with generalized weakness and unsteady gait. He showed progressive weakness of lower extremities evolving to the upper limbs over the last 10 days. Physical examination revealed absent tendon reflexes, weakness in the lower limbs greater than the arms, neuropathic pain and autonomic disorders with fluctuations of blood pressure and heart rate. He required intubation for airway protection due to loss of gag reflex and poor secretion control. MRI of the brain and spine revealed abnormal enhancement of the cauda equine. Lumbar puncture showed albuminocytologic dissociation (8 cells/mm³ & protein level 320 mg/dL). The lumbar puncture, MRI and neurologic examination were all consistent with GBS. He was treated with intravenous immunoglobulin 2gr/kg over 48 hours, showing improvement in the subsequent days. Results of SARS-CoV-2 PCR tests remained positive. He improved and was extubated 4 days later and remained in good condition.

Learning Points/Discussion: This case reveals the wide scope of presentations of COVID-19 and post-infectious processes in children. Although more cases with epidemiological data should be studied to improve this neuro-invasive potential, clinicians should constantly have a high level of suspicion for uncommon manifestations

EP413 / #594

Topic: AS13. COVID 19 and MIS-C

MULTISYSTEM INFLAMMATORY SYNDROME IN CHILDREN, POSSIBLE VACCINE ASSOCIATED

E-Posters

E-POSTER VIEWING

Romina Conti, Ana Maria Perez Benito, Judith Sanchez Manubens, Valenti Pineda Solas
Consorci Sanitari Parc Tauli, Paediatrics, Sabadell, Spain

Title of Case: Multisystem Inflammatory Syndrome in Children, possible vaccine associated

Background: Multisystem inflammatory syndrome (MIS) is a new systemic inflammatory acute onset disease that mainly affects children (MIS-C). Is temporally associated with SARS-CoV-2 infection, commonly after 3-6 weeks. A few cases of MIS following COVID-vaccination (MIS-V) in adults appeared in the last months.

Case Presentation Summary: A previously healthy 12-years-old boy consulted in the emergency room for 24 hour of fever and abdominal pain. Physical examination showed pain and defense in right iliac fossa. Blood tests showed lymphopenia (910/mcL), increased CRP (12.2mg/dl) and procalcitonine (PCT) (1.12ng/ml); SARS-Cov-2 RT-PCR was negative. An abdominal ultrasound showed signs of ileitis and adenitis. He was admitted for clinical monitoring. The patient had close contact with his sister, who had a mild COVID-19 six weeks before his admission, but he was not tested back then. He had received Pfizer/BioNTech COVID-19vaccine 2 weeks before the symptoms onset. During the admission he persisted with fever and abdominal pain, and a generalized maculo-papular rash showed-up. Follow-up tests showed further lymphopenia 450/mcL, elevation of CRP (30 mg/dl), PCT (3.5ng/ml), ferritin (1112ng/ml; NR:20-200) and IL-6 (51.8ng/ml; NR: 0-6); liver dysfunction (AST 99 U/l, ALT 76 U/L), increased D-dimer (4238ng/ml; NR:69-280) and cardiac disorder with elevated NT-BNP (612ng/ml; NR 50-125) but with a normal echocardiogram. Serologies for SARS-Cov2 came up positive for both natural infection and vaccine response. Under the suspicion of MIS-C we started treatment intravenous methylprednisolone (1mg/kg/day) for five days. The evolution was favourable and blood tests normalized.

Learning Points/Discussion: This was one more case of MIS-C, with the caveat of the relationship between the possible undiagnosed infection and the first dose of vaccine. Few cases of MIS-V have recently been reported; only two reported in children. Thus, accurate statistics and pathophysiology remain unclear.

EP414 / #793

Topic: AS13. COVID 19 and MIS-C

HOSPITALISATION DATA OF CHILDREN WITH SARS-COV-2 INFECTION IN MALTA

E-Posters

E-POSTER VIEWING

Gabrielle De Gray¹, David Pace²

¹Mater Dei Hospital, Foundation School, MSIDA, Malta, ²Mater Dei Hospital, Department Of Child & Adolescent Health, MSIDA, Malta

Backgrounds: Two years into the COVID-19 pandemic, there is better understanding of the clinical impact on children. We aimed to assess hospitalisation data for all children admitted with SARS-CoV-2 infection at Mater Dei Hospital Malta, from March 2020 to December 2021.

Methods: Case details were gathered from ward documentation. Results of investigations, clinical details on severity of infection and management were obtained from electronic records.

Results: A total of 105 children were admitted with a median age of 1.8 years (range 1 month-15 years) of who 50% were male. COVID-19 PCR results were positive prior to admission in 44.7% and found to be positive after being admitted in 55.2%. Symptomatic COVID-19 was the sole diagnosis in 45%, 10% had a dual diagnosis, 12% were asymptomatic and incidentally diagnosed after being admitted for an unrelated pathology, and 33% had incomplete documentation. The median duration of hospitalisation was 1 day. Most presented with fever (59%); this being the only symptom in 23.5% whilst others had accompanying respiratory (13.6%) and gastrointestinal (12.6%) symptoms. Overall, the commonest symptoms were cough (9.8%) and vomiting (8.5%). Complete blood counts and C-reactive protein were largely normal in all. Chest X-Ray, done in 27% of cases, was normal in 89%. Abnormalities included perihilar infiltrates and one was found to have an unrelated upper mediastinal mass. Management mostly involved observation; antibiotics were prescribed in 23% of cases (mainly for suspected pneumonia). Only 1.4% of cases required minimal oxygen via facemask.

Conclusions/Learning Points: Children below 2 years of age are more likely to be admitted to hospital with SARS-CoV-2 related symptoms. Many are discharged after exclusion of an alternative serious diagnosis, with the majority having normal blood investigations and chest X-ray findings.

EP415 / #1339

Topic: AS13. COVID 19 and MIS-C

INCIDENCE RATES AND SYMPTOMATOLOGY OF COMMUNITY INFECTIONS WITH SARS-COV-2 IN CHILDREN AND PARENTS: THE COKIDS LONGITUDINAL HOUSEHOLD STUDY

E-Posters

E-POSTER VIEWING

Marieke L.A. De Hoog¹, Judith Post², Ilse Westerhof¹, Elandri Fouri², Valerie Heuvelman³, Trisja Boom¹, Sjoerd Euser⁴, Paul Badoux⁴, Chantal Reusken⁵, Louis Bont⁶, Elisabeth Sanders^{5,6}, Vincent Jaddoe³, Bjorn Herpers⁴, Dirk Eggink⁵, Joanne Wildenbeest⁶, Liesbeth Duijts³, Marlies A. Van Houten^{2,7}, Patricia Bruijning-Verhagen¹

¹UMC Utrecht, Julius Center For Health Sciences And Primary Care, Department Of Epidemiology, Utrecht, Netherlands, ²Spaarne Gasthuis, Spaarne Gasthuis Academy, Hoofddorp, Netherlands, ³Erasmus MC - Sophia Children's Hospital, Department Of Pediatrics, Rotterdam, Netherlands, ⁴Regional Public Health Laboratory Kennemerland, Laboratory, Haarlem, Netherlands, ⁵National Institute for Public Health and the Environment (RIVM), Centre For Infectious Disease Control, Who Covid-19 Reference Laboratory, Bilthoven, Netherlands, ⁶Wilhelmina Children's Hospital UMC Utrecht, Department Of Pediatric Infectious Diseases And Immunology, Utrecht, Netherlands, ⁷Spaarne Gasthuis, Department Of Pediatrics, Haarlem and Hoofddorp, Netherlands

Backgrounds: The CoKids study aimed to estimate the community incidence of SARS-CoV-2 in children and parents and to assess the symptomatology of SARS-CoV-2 infections relative to SARS-CoV-2 negative respiratory illness episodes.

Methods: Households with a child <18 years were prospectively followed for at least 23 weeks. Participation included SARS-CoV-2 screening at 4-6 weeks intervals and active reporting of new onset respiratory symptoms. Upon new onset of respiratory symptoms or a SARS-CoV-2 positive test, a household outbreak study was initiated including daily symptom recording, repeated PCR testing (nose-throat, saliva and fecal samples) and SARS-CoV-2 antibody measurement (paired dried blood spots) in all household members. Age-stratified incidence rates, symptomatology and disease burden were compared for SARS-CoV-2 positive versus negative episodes.

Results: In total, 307 households (1209 subjects) were enrolled between August 2020 and February 2021. 11.8% of the adults received at least one dose of SARS-CoV-2 vaccination during follow-up; all children were unvaccinated. We detected 64 SARS-CoV-2 positive and 118 SARS-CoV-2 negative household outbreaks. The incidence rate <12 years for SARS-CoV-2 negative respiratory illness episodes (0.93/person-year (PY)) was at least 1.63 times higher than in children aged 12-17 years (0.25/PY) and adults (0.57/PY). The SARS-CoV-2 incidence did not differ by age group (mean across ages: 0.25/PY for confirmed cases only, and 0.37/PY including probable cases; $p>0.27$). Among children, no differences were observed in severity of SARS-CoV-2 positive versus negative respiratory illness episodes, whereas among adults, SARS-CoV-2 positive episodes had a higher number, severity of symptoms and duration ($p<0.001$).

Conclusions/Learning Points: The high SARS-CoV-2 incidence in children was similar to adults, though respiratory infections were limited to mild common cold symptoms unlike the adults.

EP416 / #1921

Topic: AS13. COVID 19 and MIS-C

ACUTE APPENDICITIS ASSOCIATED WITH SARS-COV-2 INFECTION: COINCIDENCE OR COMPLICATION?

E-Posters

E-POSTER VIEWING

Maroula Tritzali, [Sotiria Dervili](#), Irene Tzovara, Theodora Chousou, Vasiliki Bourika, Chrysi-Stefania Andriakopoulou, Chrysi-Aikaterini Georgokosta, Anastasia Polytarchou, Vana Spoulou, Athanasios Michos

"Aghia Sophia" Children's Hospital, Division Of Infectious Diseases, First Department Of Pediatrics, Medical School, National And Kapodistrian University Of Athens, Athens, Greece

Backgrounds: Children with COVID-19 have a wide range of clinical manifestations, posing challenges for the healthcare system. Despite the fact that the specific mechanism remains unclear, there have been reports of gastrointestinal symptoms mimicking surgical emergencies and an association with acute appendicitis.

Methods:: This is a retrospective analysis of children aged 0-16 years diagnosed with acute appendicitis in the context of SARS-CoV-2 infection, over a 2-year period at Athens' largest tertiary pediatric hospital.

Results: Among 1010 hospitalized patients with PCR-confirmed SARS-CoV-2 infection, 13 children (77% males), with median age of 12,5 years (IQR 5,7-14,7), developed acute appendicitis. Seven children (53,8%) had a SARS-CoV-2 PCR cycle threshold >30. The median time from symptoms to admission was one day (IQR 1-2). Five children underwent chest X-rays, two of whom exhibited bilateral basilar opacities but no respiratory symptoms. Fever and gastrointestinal symptoms were present in five children (38,4%), whereas eight had only gastrointestinal symptoms (61,6%). The median value of white blood cell count was 12.970/ μ L (IQR 9.850-16.650), C-reactive protein 54,7 mg/L (IQR 31,2-79,8) and D-Dimers 2 ng/ml (IQR 1,2-2,5). Imaging confirmation of appendicitis was made in nine children (90%) with abdominal ultrasound and in one child with computed tomography, while 3 children had only clinical diagnosis. Twelve children (92,3%) underwent appendectomy and one was managed conservatively. Two children (15,3%) were complicated with peritonitis. Antibiotics were given to all of the children, with a median treatment time of five days (IQR 3-8) and a median six-day hospital stay (IQR 3-6).

Conclusions/Learning Points: Appendicitis can arise in SARS-CoV-2 infected children and should be investigated in children presenting with gastrointestinal symptoms. It remains to be determined whether it is a result of acute gastrointestinal inflammation due to SARS-CoV-2 or rather a late hyperinflammatory complication.

EP417 / #1240

Topic: AS13. COVID 19 and MIS-C

LONG-TERM IMPACT OF SARS-COV-2 INFECTION IN CHILDREN PRESENTING TO TYGERBERG HOSPITAL DURING THE COVID-19 PANDEMIC IN CAPE TOWN, SOUTH AFRICA

E-Posters

E-POSTER VIEWING

Isabelle Dewandel¹, Rolanda Croucamp¹, Carla Mckenzie¹, Margaret Van Niekerk¹, Andrew Redfern², Lilly Verhagen^{2,3}, Mathilda Claassen⁴, Shannon Wilson⁴, Gert Van Zyl⁴, Helena Rabie², Marieke M Van Der Zalm¹

¹Desmond Tutu TB Centre, Department Of Paediatrics And Child Health, Stellenbosch University, Cape Town, South Africa, ²Department of Paediatrics and Child health, Stellenbosch University, Cape Town, South Africa, ³Radboud UMC Amalia Children's Hospital, Department Of Pediatric Infectious Diseases And Immunology, Nijmegen, Netherlands, ⁴Division of Medical Virology, Faculty of Medicine and Health Sciences, Stellenbosch University, Cape Town, South Africa

Backgrounds: Little is known about long-term impact of COVID-19 in children in low-middle income countries.

Methods: In this prospective observational cohort study, children aged 0-13 years were recruited from Tygerberg Hospital, Cape Town, South Africa between June 2020 and September 2021, presenting with either 1) acute respiratory illness, 2) confirmed COVID-19 PCR or 3) COVID-19 contact. Clinical data and serum samples were obtained at baseline and children were followed 3 months and 1 year later in a subgroup.

Results: A total of 100 children were enrolled, median age 7 months (interquartile range 2.0-32.5 months), 61 (61%) male; 2 (2%) HIV-infected and 25 (25.3%) HIV-exposed. A total of 44 (44%) children tested COVID-19 PCR positive, without significant difference in demographic characteristics according to COVID-19 status. Underlying comorbidities were seen more frequently in COVID PCR positive cases (40.9%) compared to COVID negative cases (33.9%) ($p=0.47$). One year after initial enrolment 12/41 (29.3%) children had persistent or recurrent symptoms and were more likely to be COVID-19 PCR positive (60%) versus COVID-19 negative (19.4%; $p=0.04$). A total of 40/100 (40%) children were readmitted, without significant difference between children with or without previous COVID-19 diagnosis (40.9% versus 39.3%, $p=0.87$). At baseline SARS-CoV-2 antibodies were found in 43/85 (50.6%) versus 31/39 (79.5%) 1 year later. Rising immunity was observed in both COVID-19 PCR positive and negative children (72.2% baseline versus 90% week 52, $p=0.157$ and 34.7% baseline versus 75.9% week 52, $p=0.177$, respectively).

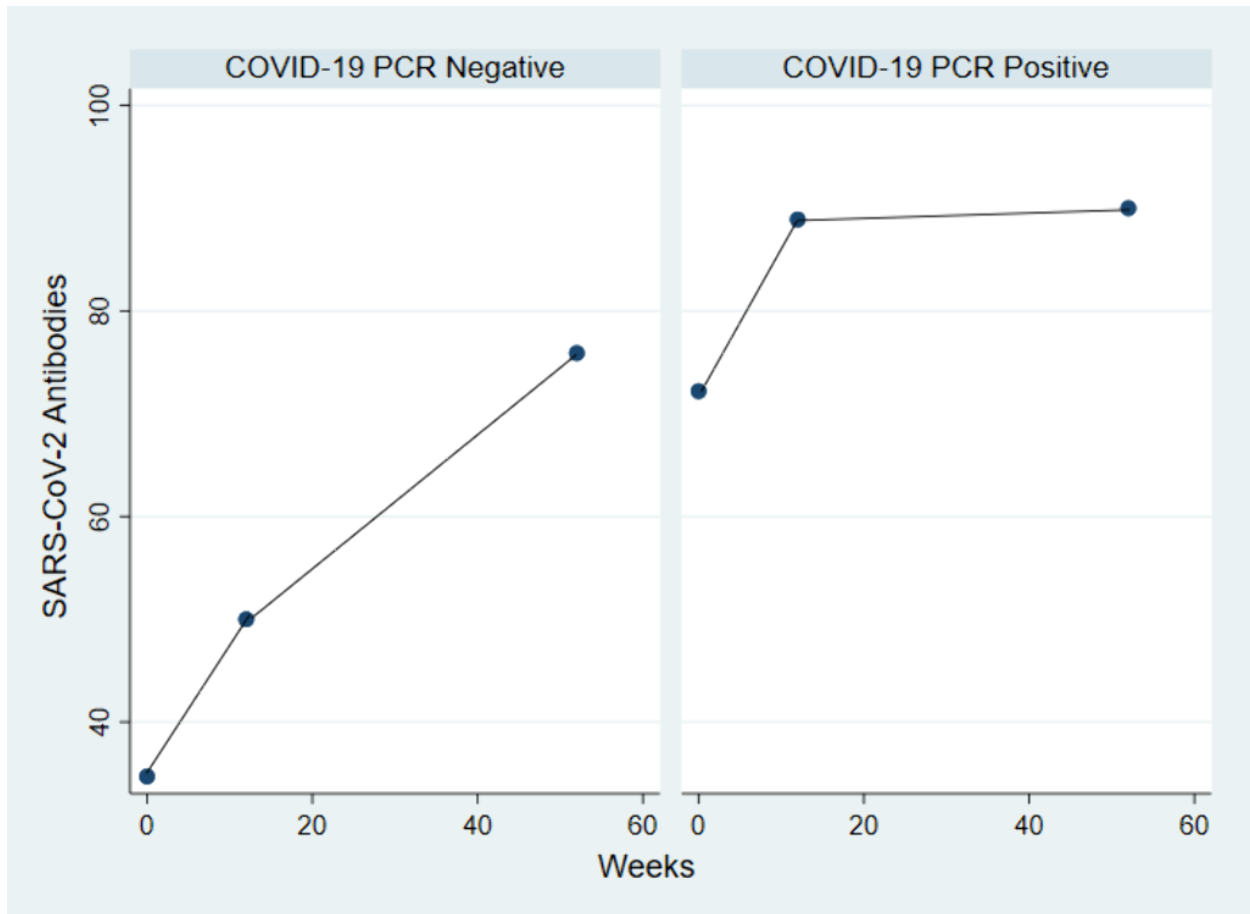

Conclusions/Learning Points: Children with confirmed SARS-CoV-2 infection were more likely to have symptoms 1 year later. An upward trend of SARS-CoV-2 immunity for COVID-19 PCR positive and negative children was seen over time, which likely reflects community transmission in the population with asymptomatic illness.

EP418 / #62

Topic: AS13. COVID 19 and MIS-C

CO-INFECTION OF MIS-C AND DENGUE FEVER IN CHILDREN: DO THEY BEHAVE DIFFERENTLY?

E-Posters

E-POSTER VIEWING

Surdeep Singh Dhooria¹, Shruti Kakkar¹, Puneet Pooni¹, Deepak Bhat²

¹Dayanand Medical College and Hospital, Pediatrics, Ludhiana, India, ²Dayanand Medical College and Hospital, Pediatrics, P.O.ROOP NAGAR, India

Backgrounds: Dengue Fever and COVID-19 share many pathogenic and clinical features which might make it very difficult to differentiate the two infections. The phenomenon of Antibody Dependent Enhancement has been described for both dengue virus as well as for SARS-CoV-2 virus resulting in escalation in degree of infection and number of complications.

Methods: We analyse cohort of 17 patients of co-infection of MIS-C with dengue fever and highlighting their salient features. Methods: This comparative cross sectional study was done at a tertiary care teaching institute. We enrolled all hospitalized children aged 1 month - 18 years and diagnosed with either MIS-C and/or dengue fever according to WHO criteria between June and December, 2020.

Results: Symptoms of diarrhoea, conjunctival injection, swelling of hand and feet, myalgia and altered sensorium was more frequent in the combination group. Of the inflammatory markers, serum ferritin and liver enzymes (SGPT), thrombocytopenia (< 1 lac/cumm) and coagulopathy (deranged aPTT) were significantly deranged in the combination group. Also, significant ascites on ultrasound was most common in combination group. Proportion of patients with "Severe dengue fever" was significantly more in combination group. Need for non-invasive ventilation, inotropic support, and steroids were also highest in the combination group. Kaplan Mayer survival curve with discharge as end point showed duration of hospital stay longest in Combination group 11.41 days (95% CI: 7.074 - 15.749) followed by MIS- C patients 8.58 days (95% CI 7.132 - 0.030) and shortest in Dengue fever patients 6.54 days (95% CI: 5.818 - 7.255) (P<0.001).

Conclusions/Learning Points: Children with co-infection of MIS-C with dengue fever need non-invasive ventilation and inotropic support more frequently and had required longer duration of hospital stay.

EP419 / #68

Topic: AS13. COVID 19 and MIS-C

MULTISYSTEM INFLAMMATORY SYNDROME WITH COVID-19 (MIS-C) IN CHILDREN: DO ALL PATIENTS NEED INTRAVENOUS IMMUNOGLOBULIN THERAPY?

E-Posters

E-POSTER VIEWING

Gurdeep Singh Dhooria¹, Deepak Bhat²

¹Dayanand Medical College and Hospital, Pediatrics, Ludhiana, India, ²Dayanand Medical College and Hospital, Pediatrics, P.O.ROOP NAGAR, India

Backgrounds: Objective: We describe clinical profile, treatment options and outcome of children with multisystem inflammatory syndrome with COVID-19 (MIS-C) hospitalized in a tertiary care centre of North India.

Methods: This is an observational study conducted in the pediatrics department of a tertiary care centre over a period of one year. 51 cases of MIS-C fulfilling the WHO criteria were included. Clinical parameters including laboratory markers, medications and outcome were obtained from patient hospital records and analyzed.

Results: Of the MIS-C cases (male, 86.3%), mean (SD) age was 7.89 (4.61) years. Median numbers of systems involved were 3 (IQR 3-4). Most common system-wise involvement were gastrointestinal system (78%) and respiratory system (49%). Of the 51 cases, MIS-C with shock was seen in 23 cases (45%), MIS-C without shock in 26 cases (51%) and Kawasaki like presentation in 2 cases (4%). Of the inflammatory markers, C reactive protein was raised in all (100%), serum ferritin (71%), D-dimers (59%), IL-6 (43%), and fibrinogen (10%) patients. 2D Echo was done in 32 cases (63%) out of which cardiac dysfunction were seen in 10/32 cases (31%). Complications seen were shock (23 cases), ARDS (2 cases), encephalopathy, digital gangrene and CHF (1 case each). PICU admission was required in 29% cases. Intravenous/ oral steroids were given in 37 cases (72.5%) and Intravenous immunoglobulin in 15 cases (29.4%). Of the 51 cases, 48 cases (94%) were discharged while 3 cases were discharged against medical advice.

Conclusions/Learning Points: Only one third of patients of MIS-C required intravenous immunoglobulin while 72 % patients received steroid therapy. Timely diagnosis and treatment of children with hemodynamic compromise is required for good outcomes.

EP420 / #1246

Topic: AS13. COVID 19 and MIS-C

CLINICAL CHARACTERISTICS AND OUTCOMES OF SARS-COV-2 INFECTION IN CHILDREN WITH CHRONIC DISEASES

E-Posters

E-POSTER VIEWING

Alfredo Diana¹, Marco Poeta¹, Laura Omaggio¹, Cristina Pisano¹, Francesca Di Candia¹, Federica Pagano², Cristina Moracas¹, Alessandra Verde¹, Alfredo Guarino², Eugenia Bruzzese¹

¹University of Naples Federico II, Translational Medical Sciences - Section Of Pediatrics, Naples, Italy, ²University of Naples, Federico II, Department Of Translational Medical Sciences - Section Of Pediatrics, Naples, Italy

Backgrounds: Chronic diseases are considered a risk factor for more severe course of COVID-19. We evaluated the clinical characteristics and outcomes of COVID-19 in children with different chronic diseases.

Methods: Patients with chronic diseases followed at Department of Paediatric of University Federico II of Naples who tested positive for COVID-19 were included. Clinical symptoms, need for hospitalization, O2 support and steroids, change in background therapy or worsening of underlying disease, were recorded. Information was collected through a telephonic interview.

Results: 113 subjects (51 males, median age 11,5 years) were enrolled: 24 had endocrinologic disorders (21%), 5 HIV (5%), 10 genetic-metabolic conditions (9%), 28 rheumatological disorders (25%), 11 liver disease (10,1%), 17 Cystic fibrosis (15%), 9 diabetes (8%), 9 oncologic diseases (8%). Forty-four (39%) patients were asymptotically infected and 69 (61%) had symptoms. Twenty-four/69 (35%) had only 1 symptom and 22 (32%) had a 3 or more symptoms. The most frequent symptom was fever (32/69, 46%), followed by headache (20/69, 29%) and myalgia (19/69, 27.5%). Nine children (8%) had a worsening of underlying disease, and 8 (7%) required a change of background therapy. Five (4,4%) children were admitted to the hospital for COVID-19 related symptoms, only one requiring steroid but not O2 supplementation for pneumonia. The mean duration of infection was 20.4 (\pm 5) days. No patient required intensive care.

Conclusions/Learning Points: Children with underlying chronic disease seem to have a similar course of SARS-CoV-2 infection compared to published data obtained in the general paediatric population. However, a non-negligible number of children present worsening of chronic condition. Therefore, we suggest that all patients with chronic disease be closely monitored via telemedicine during SARS-CoV-2 infection.

EP421 / #1019

Topic: AS13. COVID 19 and MIS-C

RISK FACTORS FOR SEVERE COVID-19 DISEASE IN CHILDREN

E-Posters

E-POSTER VIEWING

Dimitra Dimopoulou¹, Foteini Dasoula¹, Marianthi Liaska¹, Irimi Eleftheriou², Maria Tsolia³, Nikos Spyridis¹
¹National and Kapodistrian University of Athens, Second University Department Of Pediatrics, "p. & A. Kyriakou" Children's Hospital Of Athens, Athens, Greece, ²National and Kapodistrian University of Athens, Second Department Of Pediatrics, Athens, Greece, ³School of Medicine, National and Kapodistrian University of Athens, 2nd Department Of Pediatrics, "p. & A. Kyriakou" Children's Hospital, Athens, Greece

Backgrounds: Although most children with COVID-19 experience mild illness, occasionally severe respiratory disease can be seen. This study aims to describe demographic characteristics and identify risk factors for severe COVID-19 disease in children.

Methods: A retrospective study was performed between March 2020 and December 2021 in children with positive SARS-CoV-2 PCR admitted to a COVID-19 referral pediatric hospital. Medical records of children with COVID-19 were reviewed for demographic, clinical, laboratory characteristics and disease outcome. Severe COVID-19 infection was defined as the disease with respiratory distress, requiring respiratory support or critical care. Risk factors for severe disease were analyzed.

Results: Among 299 patients hospitalized with SARS-CoV-2.170 (55.9%) were males and median age was 12 months (IQR:10.8). Mean duration of hospitalization was 4.6 days. An underlying condition was reported in 25.4% of children and severe disease in 8.4%, while no death was recorded. School-aged children >6 years old and adolescents were more prone to severe disease compared to younger children and infants <12 months (OR:8.4, CI:3.1-23.2, p<0.001). Among hospitalized children, obesity (OR:25.1, CI:7.9-79.3, p<0.001) and history of asthma (OR:17.1, CI:3.6-81.7, p<0.001) were associated with severe disease. Lymphopenia (OR:9.3, CI:3.7-23.1, p<0.001) and high neutrophil to lymphocyte ratio (OR:7.5, CI:3.2-17.9, p<0.001) were related to severe COVID-19.

Conclusions/Learning Points: Older age, obesity, asthma and elevated neutrophil to lymphocyte ratio are risk factors for severe COVID-19 in children. These findings can assist pediatric providers and public health officials to tailor clinical management, pandemic planning, and resource allocation.

EP422 / #1860

Topic: AS13. COVID 19 and MIS-C

ACUTE ATAXIA WITH TREMORS ASSOCIATED WITH SARS-COV2 INFECTION IN A 18 MONTH OLD GIRL

E-Posters

E-POSTER VIEWING

Monica Rubini, Marco Pappalardo, Claudia De Guido, Valentina Maffini, Piero Veronese, Chiara Sodini, Maria Beatrice Ruozi, Sara Monaco, Laura Nicoletti, [Icilio Dodi](#)
Pediatria Generale e d'Urgenza - Ospedale dei Bambini "Pietro Barilla" Azienda Ospedaliera Universitaria di Parma, Paediatrics, Parma, Italy

Title of Case: ACUTE ATAXIA WITH TREMORS ASSOCIATED WITH SARS-COV2 INFECTION IN A 18 MONTH OLD GIRL

Background: Neurological manifestations of SARS-CoV-2 in children are very varied; ataxia is described as a rare symptom

Case Presentation Summary: 18 months old girl, With no medical history, arrived with acute onset of ataxia in apirexia, unable to stand and axial tremors evident even in sitting position. Nasal swab for Sars-Cov2 positive. Blood tests: blood count, CRP, ESR, PCT, hepato-renal function, troponins were normal; abdominal ultrasound, ECG, EEG, urine toxicology tests, urinary catecholamines research were negative. The magnetic resonance imaging (MRI) brain was normal, cerebrospinal fluid examination (CFS) did not show pleocytosis or bacterial and virological infection. Oligoclonal bands negative. Hyperpyrexia appeared after 7 days (BT 40°C) with no change in neurological symptoms. Increase in inflammation test levels: CRP 140 mg/l, PCT 8.61 ng/ml, D-dimer 2116 ng/ml, leukocytosis 20,520 /ul neutrophilia 13,420/ul, platelets 790,000/ul. Color Doppler echocardiography, chest x-ray, blood culture, hepatorenal function were normal and the same for vital parameters; second MRI brain and spine plus CFS (cytochemical research bacteria and viruses, oligoclonal bands), performed 9 days after the onset of neurological symptoms and after 2 days from the onset of fever, negative. On suspicion of Covid multisystem inflammatory syndrome (MIS-C), therapy with Ig vein and methylprednisolone ev were given, with rapid defervescence, followed by normal inflammation test levels and progressive resolution of neurological symptoms.

Learning Points/Discussion: Pediatric cases of meningo-encephalitis, acute disseminated encephalomyelitis have been described in the course of MIS-C. Few pediatric cases with ataxia are described. The absence of a neuroimaging alteration, associated with the rapid response to immunomodulatory therapy, suggests SARS-CoV-2 as the cause of neurological symptoms either through autoimmune phenomena or as complication from systemic illness.

EP423 / #716

Topic: AS13. COVID 19 and MIS-C

CO-INFECTION OF RSV AND SARS-COV-2: DOES COVID19 MATTER AT ALL IN BABIES OR IS IT JUST A BYSTANDER?

E-Posters

E-POSTER VIEWING

Maria Dominguez¹, Teresa De La Calle-Cabrera², Nieves Gutierrez-Zufiaurre³, Pilar Aparicio-Rios¹, Isabel Corral¹

¹Gerencia de Atención Primaria de Salamanca, Centro De Salud San Juan, Salamanca, Spain, ²Centro de Salud de Tamames, Gerencia De Atención Primaria De Salamanca, Salamanca, Spain, ³Hospital Universitario de Salamanca, Microbiología, Salamanca, Spain

Title of Case: Five children with RSV and SARS-CoV-2 coinfection in the month of december 2021 in the province of Salamanca, Spain.

Background: Since the new coronavirus pandemic started there has been speculation as to how co-infection with other viruses will manifest itself and if severity of the clinical picture, which for children is generally benign, would worsen. There are very few reports of children with co-infection RSV-COVID19, and those are mainly in hospitalized children, probably due to the fact that in winter 2020 the incidence of RSV was really low everywhere in the world.

Case Presentation Summary: Five children A, B, C, D and E, of ages respectively 1, 2, 5, 7 and 21 months were diagnosed with RSV and COVID19 in December 2021 in Salamanca province by Real PCR from nasopharyngeal swab sampling. A and E were admitted to hospital for O2 via nasal prongs, A also required NG feeding, and none needed intubation or ICU admission. Their clinical picture and evolution did not seem different to RSV mono-infection. Of those managed in primary care, C was ex-35/40 and presented mild bronchiolitis, and B had an upper respiratory infection without auscultation findings, and D required inhaled salbutamol and analgesia for fever. Clinical presentation of the children with coinfection was identical to the one caused by RSV in other children.

Learning Points/Discussion: RSV-COVID coinfection, ("Syncirona"?), does not present clinical differences with RSV mono-infection. Children present a mild infection from COVID even in the presence of another respiratory virus.

EP424 / #1851

Topic: *AS13. COVID 19 and MIS-C*

A 17-YR OLD WITH PRIMARY HERPETIC (HSV 1) GINGIVOSTOMATITIS TEMPORARILY ASSOCIATED WITH COVID-19

E-Posters

E-POSTER VIEWING

Liza Lea Lah, Jasmina Dovnik
General Hospital Celje, Paediatric Unit, Ljubljana, Slovenia

Title of Case: A 17-YR OLD WITH PRIMARY HERPETIC (HSV 1) GINGIVOSTOMATITIS TEMPORARILY ASSOCIATED WITH COVID-19

Background: A previously healthy 17-year-old presented to the ED due to fever and significant ulcerations of the oral mucosa. Since he had covid-19 just a week before, an immune mediated condition was suspected.

Case Presentation Summary:



He had no other clinical signs of disease and no significant abnormal values in his blood work*. He had recently had contact with his girlfriend who occasionally has herpes labialis. HSV-1 was detected from an ulceration on the lower lip. He had no previous history of herpetic ulcers and was found to be seronegative for HSV1 and HSV 2. Further ulcers appeared on the oral mucosa. He had severe gingivitis of the upper and lower jaw. His fever subsided after 2 days. He was not able to eat or drink for several days. He was treated with intravenous fluids, local anesthetics and valacyclovir (1000mg tid for 10 days). * CRP 27 mg/L, ESR 17, Leukocyte 10,5 10⁹/L (71% neutrophils, 18% lymphocytes, 9,4% monocytes), Hb 154 g/L, MCV 87fl, thrombocytes 127, D-dimer 226µg/L, ferritin 110µg/L, S-NT-proBNP 81µg/L, troponin T 9µg/L, normal electrolytes and LFT;

Learning Points/Discussion: He has been well on follow-up with changes to the oral mucosa fully regressing after two weeks. A significant specific antibody response to HSV1 has been found 6 weeks after primary infection. This case is interesting, because late clinically significant infection with HSV1 in healthy immunocompetent individuals is rare. Relative lymphopenia, which could make an individual more susceptible to other viral infections was found upon presentation.

Topic: AS13. COVID 19 and MIS-C

THE EFFECT OF DIFFERENT SARS-COV-2 VARIANTS ON CHILDREN'S HOSPITALIZATIONS AND COVID-19 SEVERITY

E-Posters

E-POSTER VIEWING

Irini Eleftheriou, Marianthi Liaska, Eleni Anastasiou, Foteini Dasoula, Dimitra Dimopoulou, Nikos Spyridis, Maria Tsolia
National and Kapodistrian University of Athens, Second Department Of Pediatrics, Athens, Greece

Backgrounds: The emergence of new SARS-CoV-2 variants raise several concerns, including their clinical impact on children.

Methods: This prospective, observational study was conducted in the second largest pediatric hospital of the country and a reference center for children with COVID-19 from central and southern Greece. We aimed to compare the characteristics of children hospitalized with COVID-19 during three pandemic waves characterized by a different SARS-CoV-2 variant's predominance: from August 1st, 2020 to January 31st, 2021 (EU1-B.1.177), from February 1st, 2021 to July 31st, 2021 (Alpha-B.1.1.7) and from August 1st, 2021 to December 26th, 2021 (Delta-B.1.617.2).

Results: Two hundred eighty-eight children hospitalized with COVID-19 were included. Of them, 9.4% (27/288), 52.4% (151/288) and 38.2% (110/288) were hospitalized during the 1st, 2nd, and 3rd study period, respectively. Demographics and data on COVID-19 severity are shown in Table 1. During the first wave, mostly infants aged less than 12 months were admitted to the hospital, while eventually older children were hospitalized. Increasing proportions of admissions of children with comorbidities were observed in the course of time. Severe/critical COVID-19 was infrequent in all waves, while ICU admissions were rare. All patients had a favourable outcome.

| | wave 1 (Aug'20-Jan'21) | wave 2 (Feb'20-Jul'21) | wave 4 (Aug'21-Dec'21) |
|--|---------------------------------|--|--|
| COVID-19 hospitalizations (per month) | 27 (4.5) | 151 (25.2) | 110 (22.7) |
| Gender, male/female (ratio) | 14:13 (1.1) | 86:65 (1.3) | 63:47 (1.3) |
| Median age (Q1-Q3) | 1.8 months (1.5-19.5 months) | 10.8 months (2.5 months-10.4 years) | 35.1 months (2.7 months-11.9 years) |
| Comorbidities (%) | 3 (11.1) | 38 (25.1) | 32 (29.1) |
| Median length of stay, days (Q1-Q3, range) | 3 (2-4.25, 2-8) | 4 (3-5, 1-17) | 3 (2-5, 1-24) |
| Severe/Critical COVID-19* (%) | 2 (7.4) | 13 (8.6) | 8 (7.2) |
| -severe COVID-19 | 1 | 11 | 5 |
| -critical COVID-19 | 1 | 2 | 3 |
| ICU admission | 0 | 1 (0.7%) | 2 (1.8%) |
| Death | 0 | 0 | 0 |

Table 1. Number of COVID-19 hospitalizations and characteristics of children hospitalized with COVID-19 during three pandemic waves

*according to WHO criteria

Conclusions/Learning Points: The higher number of hospitalizations during the 2nd and 3rd wave reflects the higher number of cases in the community at that time. No significant difference is found in disease severity between different waves/variants. The admission of older children and more children

with comorbidities is probably related to larger spread of COVID-19 in the community and/or better understanding of COVID-19 risk factors in the paediatric population.

Topic: AS13. COVID 19 and MIS-C

BRONCHIOLITIS AND COVID-19 IN INFANTS AND YOUNG CHILDREN: AN UNUSUAL PAIR

E-Posters

E-POSTER VIEWING

Irini Eleftheriou, Marianthi Liaska, Eleni Anastasiou, Foteini Dasoula, Dimitra Dimopoulou, Nikos Spyridis, Maria Tsolia

National and Kapodistrian University of Athens, Second Department Of Pediatrics, Athens, Greece

Backgrounds: Bronchiolitis is a major cause of hospitalization for children aged <2 years old. The latter usually present with mild COVID-19.

Methods: This prospective, observational study was conducted in the second largest pediatric hospital of the country and a reference centre for children with COVID-19 from the beginning of the pandemic until December 31st,2021. We aimed to document the relation between SARS-CoV-2 infection and bronchiolitis. For this purpose we studied children aged <2 years who were admitted with bronchiolitis and children of the same age admitted with COVID-19. All children were tested for SARS-CoV-2 (RT-PCR) whereas in those with bronchiolitis rapid antigen test for RSV was performed, as well.

Results:

| | 1 st wave | 2 nd wave | 3 rd wave |
|------------------------------|----------------------|----------------------|----------------------|
| Number of COVID-19 cases | 9.506 | 41.803 | 156.953 |
| Number of MIS-C cases | 32 | 47 | 40 |
| Gender, male/female (ratio) | 14:18 (0.77) | 32:15 (2.1) | 30:10 (3) |
| Median age (Q1-Q3) | 7.3 (3.4-10.2) | 8.8 (3.8-12.9) | 8.2 (5.4-13.9) |
| Cardiac involvement (%) | 20 (62.5) | 32 (68.1) | 25 (62.5) |
| -myocarditis (%) | 9 (28.1) | 19 (40.4) | 16 (40) |
| -pericarditis (%) | 8 (25) | 10 (21.3) | 8 (20) |
| -aneurysms (%) | 3 (9.4) | 3 (6.4) | 1 (2.5) |
| Mucocutaneous manifestations | 23 (71.9) | 29 (61.7) | 24 (60) |
| Gastrointestinal symptoms | 25 (78.1) | 36 (76.6) | 33 (82.5) |
| Respiratory symptoms | 9 (28.1) | 16 (34) | 13 (32.5) |
| Acute kidney injury | 3 (9.4) | 7 (14.9) | 7 (17.7) |
| ICU admission | 7 (21.9) | 14 (29.8) | 7 (17.5) |
| Death | 1 | 0 | 0 |

Table 1. Characteristics of children hospitalized with MIS-C during the three COVID-19 pandemic waves

174 children admitted with bronchiolitis and 175 children aged <2 years hospitalized with COVID-19 were included. Demographics are shown in Table 1. Two male infants, who presented with bronchiolitis, a 4-month and a 7-month-old, had a SARS-CoV-2 PCR(+) result on admission. The Cycle threshold (Ct) values were between 32.93-35.3. A second nasopharyngeal sample sent for multiplex PCR in the following 24 hours was negative for SARS-CoV-2 but positive for RSV in both cases. A 3-month-old SARS-CoV-2(+) female infant who presented with fever developed bronchiolitis on the 7th day of illness. No other virus was detected in nasopharyngeal sample using multiplex PCR. She was treated with supplemental oxygen and IV remdesivir and dexamethasone and was discharged after a total of 14 days. The incidence of bronchiolitis in children aged <2 years hospitalized with COVID-19 was estimated at 5.7/1000 COVID-19 cases.

Conclusions/Learning Points: Bronchiolitis is a rare presentation of COVID-19 in infants. Testing for other respiratory viruses, mainly RSV, is mandatory for the best isolation and management of these patients. Ct values may prove useful to evaluate acute SARS-CoV-2 infection.

EP427 / #1560

Topic: AS13. COVID 19 and MIS-C

PEDIATRIC SARS-COV-2 INFECTIONS FROM A PRIVATE HOSPITAL IN THE CITY OF BUENOS AIRES, ARGENTINA. ANALYSIS OF THE FIRST 21 MONTHS OF THE PANDEMIC.

E-Posters

E-POSTER VIEWING

Alejandro Ellis, Nadia Pauselli, Mariano Farina, Pablo Manini, Luisa De Rochebouët, Vanina Molea Citate, Ana Laura Paolillo, Soledad González, Carlos Vay, Cristian García Roig, Andrea Eguren Sanatorio Mater Dei, Pediatrics, Seleccione una opción, Argentina

Backgrounds: Background: Covid-19 pandemic by SARS-CoV-2 began at 2019 and had a rapid spread worldwide. Despite strict quarantine, the first case was admitted in April 2020. Objective: to describe the pediatric population, with suspicion and confirmation of SARS-CoV-2, in a private hospital in Argentina.

Methods: we attended 4,713 patients younger than 16 years old, since March 16 2020 up to December 15 2021. The suspects according health authorities definitions were swabbed for SARS-CoV-2 detection by real time RT PCR. The population was grouped according to age and risk factors. The criteria and duration of hospitalization were determined by the clinical evolution. Other respiratory viruses were studied by FilmArray- Biofire in patients with risk factors or admitted to the ICU.

Results: Of the 4,713 suspects, 538 were positive (11.4%: range 0.87 - 20.2%), 3,014 swabbed in the first year and 1,699 in the second. The median age of suspects and confirmed cases was 60 and 83 months in the first year; 46.5 and 112 months in the second. Among hospitalized patients, the most frequent risk factor was chronic respiratory disease. 12.3% of the suspected were admitted; 9.52% and 16.89% in the first and second year. The mean hospitalization was 5.1 and 5.9 days in the first and second year, respectively. We had not case fatality rate. Of the 579 suspected admitted 19 required mechanical ventilation (MV), 15 non invasive ventilation (NIV) and 152 supplemental oxygen. Only 3 Covid-19 required MV-NIV. The most documented non-SARS-CoV-2 respiratory viruses the ICU or with risk factors were Rhinovirus (47) and RSV (40).

Conclusions/Learning Points: Positivity of the suspects and hospitalization rates were similar with respect to international data. The MV or NIV requirement was low in Covid-19 pediatric patients.

EP429 / #1490

Topic: AS13. COVID 19 and MIS-C

NUTRITIONAL STATUS AND COVID-19 IN HOSPITALIZED CHILDREN IN THE CARIBBEAN

E-Posters

E-POSTER VIEWING

Tracy Evans Gilbert¹, Ian Hambleton², Carolyn Taylor-Bryan³, Corrine Sin Quee⁴, Sandrica Young-Pear⁵, Paula Lashley⁶, Brandon Gilbert⁷, Richille-Ann Brown⁵, Maritza Fernandes⁸, Virendra Singh⁹
¹University of the West Indies Western Campus, Child And Adolescent Health, Montego bay, Jamaica, ²University of The West Indies, The George Alleyne Chronic Disease Research Centre, Caribbean Institute For Health Research, Cave Hill, Barbados, ³University of The West Indies, Tropical Metabolism Research Unit, Caribbean Institute For Health Research (cahr), Kingston, Jamaica, ⁴University of The West Indies, School Of Clinical Medicine And Research, Nassau, Bahamas, ⁵Bustamante Hospital for Children, Paediatrics, Kingston, Jamaica, ⁶University of The West Indies, Faculty Of Medical Sciences, Cave Hill, Barbados, ⁷University of The West Indies, Faculty Of Medical Sciences, kingston, Jamaica, ⁸University of The West Indies, Department Of Clinical Medical Sciences, Eric Williams Medical Sciences Complex, St Augustine, Trinidad and Tobago, ⁹University of The West Indies, Child Health Unit Faculty Of Medical Sciences, St Augustine, Trinidad and Tobago

Backgrounds: There is limited evidence among children regarding the association between malnutrition and COVID-19 disease severity. We evaluated the impact of malnutrition on clinical outcomes in hospitalized COVID-19-infected children from birth to 17 years.

Methods: This multi-island inpatient survey presents data from nine hospitals in three Caribbean islands between September 2020- May 2021. Weight, height, and body mass index were used to assess age-appropriate nutritional status, with malnutrition classified according to The World Health Organization growth reference standards. We explored the association between malnutrition and clinical and laboratory outcomes and report two deaths in severely malnourished children with COVID 19 due to sepsis after the study window

Results: Among 180 children hospitalized for COVID-19, 6.8 % were stunted, 6.6% were underweight, 13.6% were overweight/obese, and 30% had anemia. Anemia was associated with multisystem inflammatory syndrome (MIS-C) in children but not with malnutrition. The prevalence of undernutrition (wasting, stunting, underweight) did not vary from the general pediatric population, but there was a greater-than-expected prevalence of overweight children hospitalized with COVID-19. Two deaths in infants under 1-year with severe malnutrition COVID-19 and septicemia were reported after the survey analysis.

Conclusions/Learning Points: This limited evidence does not suggest a link between undernutrition and COVID-19 disease, as hospitalizations did not exceed baseline population rates. There were more overweight children possibly reflecting an increased population prevalence. It is possible that malnourished children are relatively well protected from COVID-19 or that the prevalence of severe malnutrition was not high enough in this population to detect an association. Subsequent deaths in COVID -19 infected severely malnourished infants and limited case reports globally may provide additional insight. Severely malnourished children with COVID-19 should continue to be monitored to determine possible associated adverse outcomes.

EP430 / #1897

Topic: AS13. COVID 19 and MIS-C

EARLY-ONSET FOCAL CEREBRAL ARTERIOPATHY IN AN INFANT WITH COVID-19 INFECTION

E-Posters

E-POSTER VIEWING

Tracy Evans Gilbert¹, Kerri-Ann Mckenzie², Latisa Cudjoe³, Michelle Reece-Mills³, Corrine Sin Quee⁴

¹University of the West Indies, Child And Adolescent Health, Kingston, Jamaica, ²Falmouth General Hospital, Paediatrics, Falmouth, Jamaica, ³University of The West Indies, Child And Adolescent Health, Kingston, Jamaica, ⁴University of The West Indies, School Of Clinical Medicine And Research, Nassau, Bahamas

Title of Case: EARLY-ONSET FOCAL CEREBRAL ARTERIOPATHY IN AN INFANT WITH COVID-19 INFECTION

Background: Acute ischemic stroke is an infrequent occurrence in children with COVID-19. Adults are more likely to have comorbidities or multisystem involvement during hospitalizations. We describe a case of focal cerebral arteriopathy in a healthy infant

Case Presentation Summary: A healthy breastfed 8-week-old presented with fever, congestion, anorexia, and lethargy for one day. Mother was negative for COVID -19. On examination, the infant was lethargic, mildly dehydrated, and febrile. The examination was otherwise unremarkable. The infant had increased activity after intravenous fluids. The assessment was an acute viral illness to rule out COVID -19 and sepsis. A complete blood count, urea and electrolytes, and liver function tests were normal. Crystalline penicillin and gentamycin were started after a blood and urine culture. Within 72 hours, the fever persisted, and recurrent twitching of the right limbs and face were noted. CAT scan revealed an extensive acute left middle cerebral artery territory infarct. Blood and urine cultures were negative, absolute lymphocyte count was 1.45×10^9 cells/L, D-dimer 1286, C-reactive protein (CRP) 18 mg/L, PT 11.8/12.6, PTT 27.1/28.6, Troponin negative, lactic acid dehydrogenase (LDH) 426 U/L, positive COVID PCR and ECG was normal. The sickle screen was negative at birth. There was no other organ involvement. The patient developed right-sided hypertonia, hyperreflexia, and weakness. The infant received a 10-day course of meningitic doses of antibiotics and dexamethasone.

Learning Points/Discussion: The early evolution of focal cerebral arteriopathy in a healthy breastfed infant is a rare manifestation of COVID-19. Early activation of the coagulation and inflammatory pathways did not manifest as multisystem inflammatory syndrome and may represent a disease spectrum determined by the balance of viremia and host innate immune response.

EP431 / #449

Topic: AS13. COVID 19 and MIS-C

ONCE UPON A TIME, PNEUMONIA... SARS-COV-2: GUILTY OR INNOCENT?

E-Posters

E-POSTER VIEWING

Ana Feio, João Faria Dias, Beatriz Parreira Andrade, Susana Lopes, Sónia Carvalho, Fernanda Carvalho
Centro Hospitalar do Médio Ave, Pediatrics Department, Vila Nova de Famalicão, Portugal

Title of Case: ONCE UPON A TIME, PNEUMONIA... SARS-COV-2: GUILTY OR INNOCENT?

Background: SARS-CoV-2 infection in children is characterized by a wide spectrum of symptoms, milder than in affected adults, and may even go unnoticed. But in both groups, respiratory pathology dominates the clinical picture of patients hospitalized with COVID-19. At the pediatric age, most computed tomography (CT) findings are indeterminate, leading to the need for a high index of suspicion when screening for SARS-CoV-2 by RT-PCR is negative.

Case Presentation Summary: A previously healthy 10-year-old boy was hospitalized after several visits to the emergency department due to abdominal pain, located in the upper left quadrant, evolving for 3 weeks, associated with intermittent fever, diarrhoea and myalgia. He denied coughing or other symptoms. He denied contact with sick people. Physical examination without particularities. Analytically, he presented: CRP 12.3 mg/dL and ESR 48 mm, without leukocytosis, negative SARS-CoV-2 by RT-PCR, normal muscle enzymes and immunological study. Sterile blood culture. The chest and abdominal MRI revealed pleural effusion associated with left parenchymal condensation. Empirical antibiotic therapy was started with ampicillin and azithromycin, with no improvement in pain. On the 32nd day of disease, he presented positive IgM and IgG antibodies to SARS-CoV-2. He underwent a short course of oral corticosteroid therapy and was discharged home with daily inhaled fluticasone. The boy repeated a chest CT about 1 month after discharge, which was normal, maintaining positive IgM antibodies for SARS-CoV-2.

Learning Points/Discussion: This case demonstrates the low specificity of the symptoms caused by SARS-CoV-2 in Pediatrics, as well as of the CT findings, and shows the pulmonary involvement after asymptomatic infection. The authors thus intend to draw attention to the need to share knowledge for the early recognition of this challenging disease.

EP432 / #1104

Topic: AS13. COVID 19 and MIS-C

COVID-19 PNEUMONIA IN CHILDREN: WHAT SHOULD WE EXPECT AFTERWARDS?

E-Posters

E-POSTER VIEWING

Inês Fernandes, Ana Lemos, Ana Garcia, Tiago Silva, Rita Valsassina, Catarina Gouveia, Maria Brito
Hospital Dona Estefânia, Centro Hospitalar Universitário Lisboa Central, E.P.E, Unidade De Infeciologia
Pediátrica, Lisboa, Portugal

Backgrounds: SARS-CoV-2 infection causes a spectrum of manifestations, ranging from asymptomatic to severe respiratory and extra-pulmonary symptoms. Current data shows that prolonged symptom duration is common not only in adults with COVID-19, but also among children.

Methods: Descriptive cohort study, including children with COVID-19 pneumonia between April 2020 and December 2021. We describe the maintenance or occurrence of new symptoms and organic lesions after discharge. Statistics: SPSS 26® ($\alpha < 0,05$).

Results: Of a total of 398 patients with SARS-CoV-2 infection, 60 (15%) had COVID-19 pneumonia, with median age 4,67 years (IQR 11,58). 26 (43%) had comorbidities, mainly obesity. Admission occurred in average on the 5th day of disease. Symptoms were cough (45), fever (44), dyspnea (41) and hypoxemia (37). Disease was classified as mild (4), moderate (18), severe (30) and critical (8). Complications arose in 72% of patients: respiratory insufficiency (38), ARDS (1), pneumothorax (1), septic shock (1), cardiogenic shock (1) and heart failure (1). Therapeutical approach included remdesivir (18), corticosteroids (27), oxygen (32), high-flow oxygen therapy (3), non-invasive ventilation (2) and invasive ventilation (1). Coinfections occurred in 25 (42%) of cases. Follow up appointment was made in 47 patients (78%). 11/47 (23%) maintained cough (5), fatigue (4), chest pain (2) and dyspnea (1), 16/24 had alterations in chest x-ray after an average of 3 months and 4/47 have abnormal pulmonary function testing. No statistically significant association was found between maintenance of symptoms in the follow-up evaluation.

Conclusions/Learning Points: Our children experience similar long-term post-recovery sequelae and the main symptoms resemble those described in adults. COVID-19 pneumonia is associated with morbidity during acute period and long-term evolution. Investigation regarding the pathophysiology of long-COVID is necessary to ensure patients receive appropriate follow-up and treatment.

EP433 / #731

Topic: AS13. COVID 19 and MIS-C

FACTORS ASSOCIATED WITH PNEUMONIA IN CHILDREN WITH COVID-19

E-Posters

E-POSTER VIEWING

Todd Florin¹, Stephen Freedman², Jianling Xie², Anna Funk², Daniel Tancredi³, Nathan Kuppermann³

¹Ann and Robert H. Lurie Children's Hospital of Chicago, Pediatrics (emergency Medicine), Chicago, United States of America, ²University of Calgary, Paediatrics, Calgary, Canada, ³University of California - Davis, Emergency Medicine, Davis, United States of America

Backgrounds: Pneumonia is a significant cause of morbidity and mortality in patients with COVID-19. Although clear recommendations exist to guide chest imaging in SARS-CoV-2-infected adults, few data exist on risk factors for radiographic pneumonia to inform pediatric recommendations. We sought to identify features associated with radiographic pneumonia in SARS-CoV-2-infected children seeking emergency department (ED) care.

Methods: Prospective cohort study of children <18 years with suspected SARS-CoV-2 presenting to one of 41 EDs within the global Pediatric Emergency Research Network (PERN). This analysis was limited to those with SARS-CoV-2 detected by PCR and chest radiography performed. The primary outcome, radiographic pneumonia, was defined using the World Health Organization definition (end-point pneumonia, other infiltrate, or pleural effusion). We also report children with ground-glass opacities (characteristic of SARS-CoV-2 infections). Multivariable logistic regression was used to develop predictive models for pneumonia.

Results: Of 619 SARS-CoV-2+ children with chest radiography performed, 202 (32.6%) had radiographic pneumonia. The median age was 5 years (IQR, 1-13) with no age differences between those with and without pneumonia (Table 1). Radiographic findings included 87 with end-point consolidation, 130 with interstitial/other infiltrates, 5 with ground-glass opacities, and 20 with pleural effusions. Fever height (aOR 1.78 per °C increase, 95% CI, 1.36, 2.34), impaired oxygenation noted by decreasing SpO₂/FiO₂ (aOR 1.11, 95% CI, 1.05, 1.16), and rales or rhonchi (aOR 2.95, 95% CI, 1.51, 5.76) were associated with radiographic pneumonia (Table 2). There were no cases of end-point consolidation in children without fever, hypoxia and rales/rhonchi.

Table 1. Patient Characteristics

| | Overall (n=619) | No Radiographic Pneumonia (n=417) | Radiographic Pneumonia (n=202) | p-value |
|-----------------------------------|----------------------|--------------------------------------|-----------------------------------|---------|
| Demographics | | | | |
| Age, years | 5 (1, 13) | 5 (1, 13) | 5 (1, 14) | 0.9 |
| Sex, male | 330 (53.3) | 222 (53.2) | 108 (53.5) | >0.9 |
| Medical History | | | | |
| Pneumonia | 97 (15.7) | 53 (12.7) | 44 (21.8) | 0.005 |
| Asthma | 100 (16.2) | 68 (16.3) | 32 (15.8) | 0.9 |
| Prematurity | 85 (13.8) | 54 (13) | 31 (15.3) | 0.5 |
| Comorbidities | 166 (26.9) | 103 (24.8) | 63 (31.2) | 0.1 |
| Smoke exposure | 80 (12.9) | 61 (14.7) | 19 (9.4) | 0.07 |
| Flu vaccine | 254 (41.1) | 163 (39.2) | 91 (45.0) | 0.2 |
| Pneumococcal vaccine | | | | 0.5 |
| Not immunized | 57 (9.7) | 40 (10.2) | 17 (8.7) | |
| Partially immunized | 34 (5.8) | 20 (5.1) | 14 (7.1) | |
| Fully immunized | 497 (84.5) | 332 (84.7) | 165 (84.2) | |
| History of Present Illness | | | | |
| Illness duration, days | 3 (1, 5) | 3 (1, 5) | 3 (1, 6) | 0.01 |
| Fever duration, days | 1 (0,3) | 0.5 (0,2) | 2 (0.5,4) | <0.001 |
| Maximum Temperature >=39.0C | 181 (29.5) | 102 (24.7) | 79 (39.3) | <0.001 |
| Presenting Symptoms, | | | | |
| Cough | 339 (54.9) | 204 (49) | 135 (66.8) | <0.001 |
| Rhinorrhea | 296 (47.9) | 191 (45.9) | 105 (52) | 0.2 |
| SOB | 209 (33.8) | 122 (29.3) | 87 (43.1) | 0.001 |
| Wheezing | 85 (13.8) | 56 (13.5) | 29 (14.4) | 0.8 |
| Sputum | 84 (13.6) | 41 (9.9) | 43 (21.3) | 0.0001 |
| Sore Throat | 136 (22) | 89 (21.4) | 47 (23.3) | 0.6 |
| Abdominal Pain | 134 (21.7) | 92 (22.1) | 42 (20.8) | 0.8 |
| Vomiting | 151 (24.4) | 90 (21.6) | 61 (30.2) | 0.02 |
| Physical Examination | | | | |
| Temperature | 37.2 (36.8, 38.1) | 37.1 (36.7, 37.9) | 37.7 (37.0, 38.5) | <0.001 |
| Respiratory rate | 30.0 (23.0, 40.0) | 28.0 (22.0, 40.0) | 33.0 (24.0, 44.0) | <0.001 |
| Heart rate | 133 (110, 150) | 130 (107, 154) | 138 (121, 160) | <0.001 |
| Oxygen saturation <95% | 99 (17.6) | 49 (12.5) | 50 (29.6) | <0.001 |
| Lowest SpO2/FiO2 ratio* | 461.9 (452.4, 471.4) | 466.7 (457.1, 471.4) | 457.1 (438.1, 466.7) | <0.001 |
| General appearance | | | | |
| Well | 509 (82.5) | 370 (89.2) | 139 (68.8) | <0.001 |
| Mildly ill | 61 (9.9) | 30 (7.2) | 31 (15.3) | |
| Moderately ill | 31 (5) | 10 (2.4) | 21 (10.4) | |
| Severely ill | 16 (2.6) | 5(1.2) | 11 (5.4) | |
| Altered mental status | 27 (4.4) | 14 (3.4) | 13 (6.4) | 0.08 |
| Retractions | 62 (10) | 31 (7.5) | 31 (15.3) | 0.002 |
| Flaring | 15 (2.4) | 6 (1.4) | 9 (4.5) | 0.022 |
| Grunting | 8 (1.3) | 3 (0.7) | 5 (2.5) | 0.07 |
| Wheezing | | | | |
| None | 572 (92.6) | 389 (93.5) | 183 (90.6) | |
| Unilateral | 3 (0.5) | 1(0.2) | 2 (1) | |
| Bilateral | 22 (3.6) | 14 (3.4) | 8 (4) | |
| Rales | | | | |
| None | 582 (94.2) | 402 (96.6) | 180 (89.1) | 0.001 |
| Unilateral | 11 (1.8) | 6 (1.4) | 5 (2.5) | |
| Bilateral | 15 (2.4) | 4 (1.0) | 11 (5.4) | |
| Rhonchi | | | | |
| None | 586 (94.8) | 403 (96.9) | 183 (90.6) | 0.0003 |
| Unilateral | 4 (0.6) | 3 (0.7) | 1 (0.5) | |
| Bilateral | 23 (3.7) | 6 (1.4) | 17 (8.4) | |
| Asymmetric Breath Sounds | 23 (3.7) | 11 (2.6) | 12 (5.9) | 0.07 |
| Decreased Breath Sounds | | | | |
| None | 562 (90.9) | 391 (94) | 171 (84.7) | 0.001 |
| Unilateral | 14 (2.3) | 7 (1.7) | 7 (3.5) | |
| Bilateral | 34 (5.5) | 15 (3.6) | 19 (9.4) | |

Data reported as n(%) for categorical variables and median(interquartile range) for continuous variables.

*SpO2/FiO2 ratio is the ratio of the measured oxygen saturation (%) divided by the fraction of inspired oxygen (0.21=room air). This is an established proxy for the PaO2/FiO2 ratio as a measure of oxygenation.

Table 2. Multivariable logistic regression model for radiographic pneumonia

| Variable | OR (95% CI) | P |
|--|-------------------|---------|
| Age | | |
| <6 years old | ref | |
| 6-11.9 years old | 0.72 (0.41, 1.28) | 0.26 |
| 12-17.9 years old | 1.15 (0.71, 1.85) | 0.57 |
| Past history of pneumonia | 1.19 (0.68, 2.07) | 0.54 |
| Comorbidities | 1.25 (0.78, 2.01) | 0.3 |
| Fever duration* | 1.15 (0.95, 1.38) | 0.15 |
| Shortness of breath/difficulty breathing | 1.08 (0.69, 1.67) | 0.74 |
| Maximum temperature, per 1°C increase** | 1.78 (1.36, 2.34) | 0.00003 |
| Respiratory rate (highest), %ile, per 10 %ile increase | 1.06 (0.95, 1.19) | 0.28 |
| Heart rate (highest), %ile, per 10 %ile increase | 1.01 (0.92, 1.11) | 0.85 |
| Lowest SPO2/FIO2, per 10 units decrease | 1.11 (1.05, 1.16) | 0.00011 |
| Retractions, grunting or flaring | 1.29 (0.62, 2.7) | 0.49 |
| Rales/rhonchi | 2.95 (1.51, 5.76) | 0.002 |
| Asymmetric breath sounds | 1.7 (0.52, 5.53) | 0.38 |
| Decreased breath sounds | 1.59 (0.75, 3.36) | 0.23 |

*Fever duration coded as 0 vs <1 vs >=1 day of fever based on distribution

**Maximum temperature reported at home or within the ED, whichever was higher

Conclusions/Learning Points: One in three children with COVID-19 who had chest radiography performed had pneumonia. Factors associated with pneumonia included height of fever, impaired oxygenation, and rales or rhonchi. These findings can guide chest radiography use in children with COVID-19.

EP434 / #814

Topic: AS13. COVID 19 and MIS-C

PERICOVID MALAWI; UNDERSTANDING COVID-19 IN PREGNANT WOMEN AND THEIR BABIES; A PROSPECTIVE COHORT STUDY

E-Posters

E-POSTER VIEWING

Samantha Lissauer^{1,2}, Maryke Nielsen^{1,2}, Priscilla Mvula-Mtila³, Zion Pondani⁴, Smart Njowa⁴, Louise Afran⁵, Catherine Anscombe⁶, Thokozile Ngulube⁴, Vita Nyasulu⁴, Charlotte Van Der Veer⁷, Gladys Gadama⁸, Kondwani Kawaza², Luis Gadama³, Bridget Freyne¹

¹University of Liverpool, Infection & Global Health, L EA, United Kingdom, ²Queen Elizabeth Central Hospital, Paediatrics, Blantyre, Malawi, ³QECH, Obstetrics & Gynaecology, Blantyre, Malawi, ⁴Malawi-Liverpool Wellcome Trust, Early Life Infection, Blantyre, Malawi, ⁵Malawi-Liverpool Wellcome Trust, Immunology, Blantyre, Malawi, ⁶Malawi-Liverpool Wellcome Trust, Molecular Virology, Blantyre, Malawi, ⁷University of Liverpool, Translational Medicine, Liverpool, United Kingdom, ⁸Kamuzu University of Health Sciences, Department Of Obstetrics, Blantyre, Malawi

Backgrounds: PeriCOVID Africa is a collaboration between study sites in five Africa countries to describe the sero-epidemiology and clinical characteristics of COVID-19 amongst pregnant women and their infants. Here we report results from 387 mother-infant dyads in Malawi.

Methods: Maternal serum and cord blood was collected for sero-epidemiology studies using total antibody ELISA (WANTAI) from all participants. Confirmatory PCR testing was done on those with probable COVID-19. Summary statistics and two-way tests of association (Fisher exact test) were done to compare clinical outcomes of COVID-19 exposed and unexposed infants.

Results: Of 387 women recruited, 5 (1.3%) were vaccinated against COVID-19. 61 (15.8%) were HIV positive and 13 (3.4%) were syphilis positive. Sars-CoV-2 Seropositivity was 66.2% and 57.2% in maternal and cord blood respectively. There were 41 cases of confirmed COVID-19 at delivery and 3 infants were Sars-CoV-2 PCR positive on day 1. Infants of mothers with COVID-19 were more frequently admitted to NICU (41% v 30%, $p=0.012$). There was no difference in rates of neonatal death, prematurity or low birth weight between infants exposed to COVID-19 in utero or at delivery compared to unexposed infants.

Conclusions/Learning Points: Over two thirds of women presenting to hospital for delivery were seropositive in this setting. There was good concordance between maternal and cord blood serology. Despite high rates of infectious co-morbidity and minimal vaccine exposure, COVID-19 disease in pregnancy or at delivery was not associated with an increased risk of adverse birth outcomes, although infants were more likely to be admitted to the NICU after birth. There were 3 cases of confirmed perinatal COVID-19 infection, all of which occurred during the most recent wave of COVID-19 disease associated with the Omicron variant.

EP435 / #1395

Topic: AS13. COVID 19 and MIS-C

VARIATION IN SARS-COV-2 SEROPREVALENCE IN CHILDREN IN THE REGION OF ASTURIAS, NORTHERN SPAIN

E-Posters

E-POSTER VIEWING

Elisa García¹, Laura Calle-Miguel², Ignacio Carvajal³, Ángeles Cobo¹, Juan Pérez², Cristina Molinos⁴, María Morán⁵, Cristina Suárez⁶, Cristina Amigo⁷, Reyes Fernández⁸, Carlos Pérez⁴, Belén Moreno⁹, David Pérez¹⁰, Mercedes Rodríguez¹¹

¹Centro de Salud Laviada, Pediatrics, Gijón, Asturias, Spain, ²HOSPITAL UNIVERSITARIO CENTRAL DE ASTURIAS, Pediatrics, OVIEDO, Spain, ³Centro de Salud La Ería, Pediatrics, Oviedo, Spain, ⁴Hospital Universitario de Cabueñes, Pediatrics, Gijón, Spain, ⁵Centro de Salud Puerta la Villa, Pediatrics, Gijón, Spain, ⁶Hospital del Oriente de Asturias Francisco Grande Covián, Pediatrics, Arriondas, Spain, ⁷Hospital Álvarez Buylla, Pediatrics, Mieres, Spain, ⁸Hospital Valle del Salón, Pediatrics, Langreo, Spain, ⁹Centro de Salud de Contrueces, Pediatrics, Gijón, Spain, ¹⁰Hospital Universitario San Agustín, Pediatrics, Avilés, Spain, ¹¹Hospital Universitario Central de Asturias, Microbiology Department, Oviedo, Spain

Backgrounds: Up-to-date seroprevalence estimates are very important to describe the SARS-CoV-2 landscape and to guide public health decisions. Very few studies have been performed in children. The aim of this study is to estimate longitudinal changes in seroprevalence in children in a region in northern Spain.

Methods: Prospective multicentre cohort study with subject recruitment from July 2020 to September 2020. Children (up to 14 years old) from the different areas in Asturias were included and followed up until September 2021. The sample was divided into three subgroups: 0-4 years (18.9%), 5-9 years (32.3%) and 10-14 years (48.8%) representing the age and demographic distribution of the children in the region (around 100.000 children). 75.4% of the children lived in cities, 7.2% in peri urban districts and 17.4% in rural areas. Venous blood samples were collected every six months, during three testing rounds and analyzed with the LIAISON SARS-CoV-2 TrimericS IgG assay. The evolution of SARS-CoV-2 seroprevalence during the study was analyzed.

Results: Two hundred children were recruited (51.5% girls, median age 10.1 years). The overall seroprevalence has significantly increased during the study from round 1 [3/195; 1.5% (95% CI 0.3-4.4)] to round 2[16/176; 9.1 % (95% CI 4.6-13.7)] and round 3 [28/169; 16.7% (95% CI 10.9%-22.2%)] ($p < 0.001$). Significant differences have been found in all the age groups: 0-4 years ($p = 0.001$), 5-9 years ($p = 0.028$) and 10-14 years ($p = 0.021$), between children living in urban areas ($p < 0.001$) and among those with 4 to 5 family members ($p < 0.001$).

Conclusions/Learning Points: The SARS-CoV-2 seroprevalence in children has remarkably increased during the time of our study being the young children living in urban areas and those with more family members more likely to be seropositive

EP436 / #1417

Topic: AS13. COVID 19 and MIS-C

COMPARISONS BETWEEN CHILDREN WITH POSITIVE AND NEGATIVE SARS-COV-2 ANTIBODIES. A PROSPECTIVE MULTICENTRE COHORT STUDY

E-Posters

E-POSTER VIEWING

Elisa García¹, Mercedes Rodríguez², David Pérez³, Sara Lozano⁴, Eva Fernández⁵, Helena Higuelmo⁶, Cristina Rodríguez³, M^aAgustina Alonso⁷, Noelia García⁸, Águeda García⁹, Carlos Pérez¹⁰, Belén Moreno¹¹, Laura Calle-Miguel²

¹Centro de Salud Laviada, Pediatrics, Gijón. Asturias, Spain, ²Hospital Universitario Central de Asturias, Microbiology Department, Oviedo, Spain, ³Hospital Universitario San Agustín, Pediatrics, Avilés, Spain, ⁴Centro de Salud de Tapia, Pediatrics, Tapia de Casariego, Spain, ⁵Hospital Carmen y Severo Ochoa, Pediatrics, Cangas del Narcea, Spain, ⁶Centro de Salud El Quirinal, Pediatrics, Avilés, Spain, ⁷Hospital Universitario Central de Asturias, Pediatrics, Oviedo, Spain, ⁸Centro de Salud de Teatinos, Pediatrics, Oviedo, Spain, ⁹Centro de Salud de Vallobín, Pediatrics, Oviedo, Spain, ¹⁰Hospital Universitario de Cabueñes, Pediatrics, Gijón, Spain, ¹¹Centro de Salud de Contrueces, Pediatrics, Gijón, Spain

Backgrounds: It is unclear what proportion of children are asymptomatic and which symptoms are most associated with paediatric SARS-CoV-2 infections. This cohort study monitors the seroprevalence, symptoms, sociodemographic and lifestyle factors of the enrolled children.

Methods: Prospective multicentre cohort study with subject recruitment from July 2020 to September 2020. Children from different areas in a region in Northern Spain (up to 14 years old) were included and followed up until September 2021. Venous blood samples were collected from participants every six months, during three testing rounds, and analyzed with the LIAISON SARS-CoV-2 TrimericS IgG assay, which is a new generation of chemiluminescence immunoassay (CLIA). Data regarding epidemiological features, contact tracing, symptoms, and virological tests were collected. The differences between children with positive and negative SARS-CoV-2 antibody tests were analyzed.

Results: Two hundred children were recruited of whom 169 participated until the end of the study. (51.5% girls, median age 10.1 years). 28 children had SARS-CoV-2 antibodies, resulting in an overall seroprevalence of 16.7% (95% CI 10.9%-22.2%). None of the children who were previously positive became seronegative. Young children (0-4 years) were more likely to be seropositive ($p=0.029$), as well as children living in urban areas ($p=0.027$). Fatigue was the only COVID-19-compatible symptom that was more frequent in seropositive than in seronegative children ($p=0.033$). 20/28 seropositive children had a virologic test performed which was negative in eight cases (40%).

Conclusions/Learning Points: Younger children and those living in cities have more frequently SARS-CoV-2 antibodies. COVID-19-compatible symptoms are very unspecific in children. This could partly explain the high proportion of seropositive children who were not previously diagnosed.

EP437 / #1449

Topic: AS13. COVID 19 and MIS-C

SARS-COV-2 RBD-SPECIFIC MEMORY B CELL RESPONSES INDUCED BY THE BNT162B2 MRNA VACCINE IN HEALTHY ADULTS

E-Posters

E-POSTER VIEWING

Maria Geropeppa¹, Ioanna Papadatou¹, Panagiotis Sarantis², Marianna Tzanoudaki³, Tina Bagratouni⁴, Evangelos Terpos⁴, Vassiliki Spoulou^{1,5}

¹National and Kapodistrian University of Athens, Medical School, Immunobiology And Vaccinology Research Laboratory, First Department Of Paediatrics, "Aghia Sophia" Children's Hospital, Athens, Greece, ²National and Kapodistrian University of Athens, Molecular Oncology Unit, Department Of Biological Chemistry, Athens, Greece, ³Specific Reference Centre for Primary Immunodeficiencies-Paediatric Immunology, "Aghia Sophia" Children's Hospital, Department Of Immunology & Histocompatibility, Athens, Greece, ⁴National and Kapodistrian University of Athens, Department Of Clinical Therapeutics, Athens, Greece, ⁵National and Kapodistrian University of Athens, First Department Of Paediatrics, 'Aghia Sophia' Children's Hospital, Athens, Greece

Backgrounds: mRNA vaccines against SARS-CoV-2 have been proven to induce significant humoral responses by the generation of Receptor-Binding Domain(RBD)-binding IgG and neutralizing antibodies(NAbs). However, circulating antibodies decrease significantly within months after immunization and the induction of immunological memory by mRNA vaccines remain unclear. Here we investigate the generation and persistence of RBD-specific memory B cells(MBCs) induced by the Pfizer/BioNTech mRNA vaccine(BNT162b2).

Methods: 23 adults were immunized with 2 doses of BNT162b2 and peripheral blood mononuclear cells(PBMCs) and sera were collected before(Day 22) and four weeks(Day 50) after the 2nd dose. NAbs against SARS-CoV-2 were assessed by ELISA. RBD-specific B cells(CD19+RBD-tetramers+) and RBD-specific MBCs(CD19+RBD-tetramers+CD27+) were enumerated by Flow Cytometry.

Results: NAbs were enriched on day 50 (median NAbs inhibition pre-2nd dose: 43.63% vs post-2nd dose: 91.56%, $p < 0.0001$). RBD-specific B cells increased on day 50 (% within total B cells: 0.2075% vs 0.4132%, $p = 0.0027$). RBD-specific MBCs also expanded after the 2nd dose (% within total B cells: 0.06896% vs 0.09965%, $p = 0.0233$). On day 22, MBCs consisted mainly of IgM MBCs (% within total MBCs: switched MBCs 31.43% vs IgM MBCs 68.57%, $p = 0.67$), while the 2nd dose promoted the enrichment of switched MBCs (swMBCs 50% vs IgM MBCs 50%, $p = 0.27$). Repeated Measures Correlation showed that the fold increase of RBD-specific B cells and MBCs were positively correlated with the fold increase of NAbs ($r = 0.511$, $p = 0.011$ and $r = 0.470$, $p = 0.020$, respectively).

Conclusions/Learning Points: Immunization with a single dose of BNT162b2 resulted in induction of RBD-specific B cells, MBCs and NAbs, which all increased significantly after the 2nd dose. Switched MBCs, which expanded after the 2nd dose, are thought to be longer-lived and have higher affinity than non-switched MBCs, contributing to a longer-sustained and more targeted immunological memory. High antibody titers achieved shortly after vaccination are correlated with a more robust memory B cell response and thus may correspond to the establishment of stronger immunological memory against SARS-CoV-2. These findings provide insight into immunological memory induced by mRNA vaccines and could have implications in the optimization of vaccination strategies.

EP438 / #529

Topic: AS13. COVID 19 and MIS-C

FEATURES OF MULTISYSTEM INFLAMMATORY SYNDROME IN CHILDREN'S HOSPITAL OF TUNIS

E-Posters

E-POSTER VIEWING

Meriem Glai, Rahma Guedri, Zohra Fitouri, Saayda Ben Becher
Béchir Hamza Children's Hospital, Pediatric Emergency And Outpatient Department (puc), Tunis, Tunisia

Backgrounds: The COVID-19 infection seemed to be mild in children. However, some of them develop a postinfectious and immune entity called multisystem inflammatory syndrome (MIS-C syndrome).

Methods: We conducted a retrospective study from March 15, 2020 to March 15, 2021 in the COVID-19 unit of the children's hospital of Tunis. Patients included met the case definition of the World Health Organization (WHO) for MIS-C.

Results: We included 32 patients (median age: 7.5 years, range: 18 months-13 years). This cases occurred one month after the peak of admission for COVID-19 infection. Twenty two were boys (66.6%). Seven had underlying comorbidities (21.9%). Fever was present in all cases. Mucocutaneous manifestations was found in 29 (90.6%) including conjunctival injection and skin rash in 23 (71.9%) respectively, cracked lips in 22 (68.8%), lymphadenopathy in 7 (21.9%) and swollen hands and feet in 4 (12.5%). Cardiac involvements were present in 22 (68.8%) including myocarditis in 13 and cardiogenic shock in 6. Eighteen patients (56.3%) presented with digestive symptoms with abdominal pain suggesting acute appendicitis. Neurological signs were found in 9 (28.1%) as well as meningism, whining and convulsion. Respiratory signs were present in only two cases (6.3%). Laboratory investigations indicated high CRP levels (90.6%, range: 38,7-411 mg/L), raised leukocyte (21.9%, median value: 20650 cells/ml), lymphocytopenia (75%, median value: 896 cells/ml), elevated Ddimer (65.6%, range: 500-20780 ng/mL) and elevated troponin in 13 (range: 12,86-25000 ng/mL). Positive RT-PCR of SARS-CoV-2 on nasopharyngeal swab was in 5 and positive serology was in 22. Radiological findings were mainly effusions and wall thickening. Echocardiography was performed in 100% of patients. Impaired left ventricle systolic function was assessed in 10 patients (31.3%). Coronary dilation was showed in 7 cases (21.8%) and mitral insufficiency in 5 (15.6%). All patients received immunomodulatory therapy including immunoglobulin (100%) and corticosteroids (75%). Six patients received vasopressors. No deaths occurred. All patients had favorable course.

Conclusions/Learning Points: MIS-C syndrome is a threatening feature of COVID-19 in children which need to be more understand.

Topic: AS13. COVID 19 and MIS-C

COVID-19 INFECTION IN CHILDREN DURING THE FIRST AND SECOND WAVES IN TUNIS

E-Posters

E-POSTER VIEWING

Meriem Glai, Rahma Guedri, Zohra Fitouri, Saayda Ben Becher

Béehir Hamza Children's Hospital, Pediatric Emergency And Outpatient Department (puc), Tunis, Tunisia

Backgrounds: First cases of COVID-19 infection in children in Tunisia were declared since september 2020. We aimed to describe epidemiological and clinical features of COVID-19 in children during the first and second waves of the pandemic.

Methods: It was a retrospective review of cases of SARS-CoV-2 infection among children admitted to the COVID unit in the children's hospital Bechir Hamza of tunis between March 2020 and March 2021. COVID infection was confirmed by RT-PCR on nasopharyngeal swab. Cases of multisystem inflammatory syndrome (MIS-C) met the WHO definition.

Results: Ninety nine patients were enrolled (acute infection:67; MIS-C syndrome:23). The demographic and clinical characteristics of all patients are displayed in table 1. Fever characterized both forms of infection. The respiratory impairment marked the acute form. Digestive involvement was second, followed by neurological and skin signs. The progression to acute respiratory distress was only found in three cases. The management was symptomatic. The use of oxygen was only necessary in 22%. Mortality represented only 3% of acute forms. In MIS-C, respiratory signs were absent. It was marked by cutaneous, abdominal and cardiac signs. Myocarditis and cardiogenic shock were the most feared complications. The biological inflammatory syndrome was more pronounced. Treatment was more codified and was based on immunomodulators (intravenous immunoglobulin in 100% and corticosteroids in 75%) and anticoagulant therapy. The treatment, which was early and appropriate, was able to save all patients. Table 1: Demographic and clinical characteristics of all patients

| | |
|--|---------------------------------|
| N:99 | Acute infection:67 |
| Median age(year),range | 3.8;(10 days-15 years) |
| Gender:male,n(%) | 42(62.7%) |
| Chronic disease,n(%) | 35(51.5%) |
| Prior contact,n(%) -in family,n(%) -in school,n(%) -in hospital,n(%) | 35(52%) -27(77%) -1(3%) -7(20%) |
| Fever,n(%) | 53(79.1%) |
| Respiratory signs | 38(56.7%) |
| Cardiac signs | 2(3%) |
| Abdominal signs | 13(19.4%) |
| Neurological signs | 8(11.9%) |
| Dermatological signs | 5(7.5%) |

Conclusions/Learning Points: Despite the severity of some initial clinical pictures, mortality was rarely reported.

EP440 / #958

Topic: AS13. COVID 19 and MIS-C

COMPARISON OF CLINICAL OUTCOME BETWEEN IMMUNOCOMPETENT AND IMMUNOCOMPROMISED CHILDREN AGED 1-12 YEARS ADMITTED WITH ACUTE COVID – 19 INFECTION – A RETROSPECTIVE REVIEW

E-Posters

E-POSTER VIEWING

Neha Goel, Amitabh Singh, Sumit Mehndiratta, Rani Gera
VARDHAMAN MAHAVIR MEDICAL COLLEGE AND SAFDARJUNG HOSPITAL, Pediatrics, New Delhi, India

Backgrounds: The pandemic caused by severe acute respiratory syndrome coronavirus 2 (SARS CoV-2) has created havoc in adults and children alike. Immunocompromised children are considered a high-risk group for the severe manifestation of COVID -19 infection. There are conflicting reports on the outcome of SARS CoV-2 infection in immunocompromised children. The study was aimed to determine the difference in clinical outcome between immunocompetent and immunocompromised children aged between 1 – 12 years in terms of their COVID – 19 manifestations.

Methods: A retrospective chart review of children admitted with COVID -19 infection in a tertiary care pediatric hospital in Northern India from October 1, 2020, to March 31, 2021, was done. There were fifty-two COVID -19 positive children aged 1-12 years admitted during the study period. The study participants were divided into two groups- immunocompetent and Immunocompromised patients. For every one Immunocompromised child enrolled in the study, a consecutive immunocompetent child was enrolled. Their clinical features, laboratory parameters, treatment needs, and outcome were compared.

Results: Among 35 patients enrolled (the first enrollment was of an immunocompetent child, after that one consecutive admission of immunocompetent after every immunocompromised child was done. Seventeen children were immunocompromised and eighteen children were immunocompetent.), 17 were immunocompromised and 18 were immunocompetent. The median duration of stay, clinical features, laboratory parameters, and severity of illness, treatment needs, and outcome was compared between the two groups.

Conclusions/Learning Points: Immunocompromised children are not at a higher risk of severe COVID-19 manifestation compared to immunocompetent children.

EP441 / #528

Topic: AS13. COVID 19 and MIS-C

BURDEN OF SARS-COV-2 AND PROTECTION FROM SYMPTOMATIC SECOND INFECTION IN CHILDREN

E-Posters

E-POSTER VIEWING

Aubree Gordon¹, John Kubale¹, Angel Balmaseda², Aaron Frutos¹, Nery Sanchez³, Miguel Plazaola³, Sergio Ojeda³, Saira Saborio², Roger Lopez², Carlos Barilla², Gerald Vasquez², Hanny Moreira², Anna Gajewski³, Lora Campredon¹, Hannah Maier¹, Mahboob Chowdhury¹, Cristhiam Cerpas², Eva Harris⁴, Guillermina Kuan³

¹University of Michigan, Epidemiology, Ann Arbor, United States of America, ²Sustainable Sciences Institute, Laboratory, Managua, Nicaragua, ³Sustainable Sciences Institute, Health Center, Managua, Nicaragua, ⁴University of California, Berkeley, Infectious Diseases And Vaccinology, Berkeley, United States of America

Backgrounds: The impact of the SARS-CoV-2 pandemic on children remains unclear. Better understanding of the burden of COVID-19 among children and their protection against re-infection is crucial as they will be among the last groups vaccinated. We characterized the burden of COVID-19 and assessed how protection from symptomatic re-infection among children may vary by age.

Methods: We conducted a prospective, community-based pediatric cohort study of children aged 0-14 years in Managua, Nicaragua from March 1, 2020 through October 15, 2021. Respiratory samples were tested for SARS-CoV-2 via RT-PCR. Blood samples were tested for antibodies against SARS-CoV-2 by ELISA. Incidence rates and protection from re-infection were calculated using a Poisson distribution.

Results: A total of 1964 children participated in the cohort. Overall, 49.8% of children tested were seropositive over the course of the study. There were also 207 PCR-confirmed COVID-19 cases, 12 (6.4%) of which were severe enough to require hospitalization. Incidence of COVID-19 was highest among children aged <2 years—16.1 per 100 person-years (95% Confidence Interval [CI]: 12.5, 20.5)—approximately three times that of children in any other age group assessed. Additionally, 41 (19.8%) symptomatic SARS-CoV-2 episodes were reinfections, with younger children slightly more protected against symptomatic reinfection. Among children aged 6-59 months, protection was 61% (Rate Ratio [RR]:0.39, 95% CI:0.2,0.8), while protection among children aged 5-9 and 10-14 years was 64% (RR:0.36,0.2,0.7), and 49% (RR:0.51,0.3-0.9), respectively.

Conclusions/Learning Points: In this prospective community-based pediatric cohort rates of symptomatic and severe COVID-19 were highest among the youngest participants, with rates stabilizing around age 5. Reinfections represent a large proportion of PCR-positive cases, with children <10 years displaying greater protection from symptomatic reinfection. A vaccine for children <5 years is urgently needed.

EP444 / #1299

Topic: AS13. COVID 19 and MIS-C

RISK FACTORS OF THE SEVERE COURSE OF COVID19 IN NEONATES AND INFANTS

E-Posters

E-POSTER VIEWING

Anahit Grigoryan, Karine Simonyan, Gayane Danielyan
YSMU, Muratsan University Hospital, Yerevan, Armenia

Backgrounds: Coronavirus disease 2019 is an illness caused by severe acute respiratory syndrome coronavirus 2(SARS-CoV-2). Although children seem to have less severe clinical symptoms of the disease, the potential harm of this disease remains largely unknown especially in neonates.

Methods: Various clinical parameters were evaluated in the cases of COVID-19 among the patients admitted to Pediatric department of the Muratsan University Hospital in Yerevan, for the period of 01.03.2020 to 31.12.2020. Inclusion criteria were 0-12 mo patients infected by SARS-CoV-2, confirmed with a PCR test.

Results: A total of 130 Covid19 infected patients were selected for this study. The mean age of admitted children was 63.49 ± 5.73 days, 56.8% of them were boys. Boys were 59.99 ± 7.58 days old, girls- 68.11 ± 8.80 days old ($P < 0.05$). 74.2% was diagnosed with nasopharyngitis, the 13.6 % had bronchiolitis, 10.6% pneumonia and 1.5% enterocolitis. There were no detected gender based differences among baseline characteristics.

Conclusions/Learning Points: Covid19 is mostly moderate disease among hospitalized infants. Infants with comorbidities or those who was born by Cesarean section are more likely to develop a severe form of the disease. The following risk factors could be discussed as predisposition for severe outcome in neonates and infants.

EP446 / #732

Topic: AS13. COVID 19 and MIS-C

GUILLAIN-BARRÉ SYNDROME AS A CONSEQUENCE OF ASYMPTOMATIC COVID-19 IN ADOLESCENCE: A CLINICAL CASE

E-Posters

E-POSTER VIEWING

Mykola Haras, Roman Tkachuk

Bukovinian State Medical University, Pediatrics And Pediatric Infectious Diseases, Chernivtsi, Ukraine

Title of Case: Guillain-Barré syndrome as a consequence of asymptomatic COVID-19 in adolescence: a clinical case

Background: The growing number of reports of patients with COVID-19 with neurological disorders may be due to the neuroinvasive properties of the SARS-CoV-2 virus, which can be considered a new neuropathogen. In this aspect, Guillon-Barre syndrome can be considered as one of the long-term consequences of COVID-19 due to the neuropathogenicity of the virus.

Case Presentation Summary: The report presents a clinical case of Guillain-Barré syndrome in female adolescent after asymptomatic acute viral infection caused by SARS-CoV-2. A girl was hospitalized in Chernivtsi Regional Pediatric Clinical Hospital in severe neurological condition. A girl has been healthy for the last 2 years. Confirmed cases of COVID-19 have been reported in the family and at the school. After a sudden attack of pain, acute ascending polyradiculoneuropathy in the form of flaccid paraplegia of the lower extremities, pelvic dysfunction and paraparesis of the upper extremities were developed. The results of laboratory tests: leukocytosis, increased levels of procalcitonin, CRP, D-dimer, positive IgM and IgG to SARS-CoV-2. Absent of impulses conducting of lower extremities and decreased amplitude M and H responses were registered as results of stimulation electroneuromyography. The treatment package included the use of oxygen therapy, infusion and inotropic therapy, intravenous normal human immunoglobulin, glucocorticosteroids, short-acting anticoagulants, gymnastics and massage. The child's condition was characterized by slow positive dynamics with the restoration of motor functions of the extremities and sensitivity during the month.

Learning Points/Discussion: Each case of post-infection ascending polyradiculoneuropathy should include laboratory and instrumental tests to confirm/refute the diagnosis of Guillain-Barré syndrome. In case of suspicion of Guillain-Barré syndrome initial intravenous normal human immunoglobulin and short-term systemic glucocorticosteroids and neuroprotective drugs can be considered justified.

EP447 / #1580

Topic: AS13. COVID 19 and MIS-C

AGE FEATURES OF COVID-19 IN INFANTS AT THE BEGINNING OF THE PANDEMIC

E-Posters

E-POSTER VIEWING

Mykola Haras¹, Lorina Ivanova¹, Larysa Huk²

¹Bukovinian State Medical University, Pediatrics And Pediatric Infectious Diseases, Chernivtsi, Ukraine, ²Chernivtsi Regional Pediatric Hospital, Infectious Diseases, Chernivtsi, Ukraine

Backgrounds: Polymorphism and nonspecificity clinical picture of COVID-19 in infants, in addition to respiratory symptoms, is the presence of gastrointestinal symptoms, including nausea, vomiting, diarrhea, abdominal pain; also described cases of idiopathic intussusception.

Methods: 188 inpatient cards of children who were hospitalized in the infectious diseases departments of Chernivtsi Regional Children's Clinical Hospital with COVID-19 infection were analyzed, in particular, 63 children under 1 year of age (1st group) and 125 children aged 1 year and older (2nd group, comparison group). A complex of anamnestic, epidemiological and clinical characteristics of COVID-19 infection was determined in hospitalized children.

Results: During the analysis of the data it was found that the epidemiological significance was related to family contacts, unidentified non-family sources of infection were observed in a quarter of infants (25,4%) and 39,2% of children of group II ($p < 0,05$). The most common clinical symptoms in the general cohort were fever, weakness and lethargy, loss of appetite, and signs of catarrhal pharyngitis. Symptoms of upper respiratory tract disease prevailed in infancy, in particular, most had nasal congestion (55,6% vs. 40,2%, $p > 0,05$), 30,2% infants had rhinorrhea (16,8% in the 2nd group, $p < 0,05$), while in the comparison group the symptoms from the lower respiratory tract dominated, in particular, cough was significant more often observed (59,2% vs. 26,9% in the 1st group, $p < 0,05$). Lesions of the lower respiratory tract with the development of pneumonia were significant more common in 32,0% of children in 2nd group and only in 8,0% of infants ($p < 0,05$).

Conclusions/Learning Points: Epidemiologically, the start of COVID-19 pandemic in Chernivtsi region with restrictive quarantine measures was characterized by a predominance of familial infection and a significant proportion of unexplained extracurricular sources of infection in children. In most infants with coronavirus disease caused by the new SARS-CoV-2 coronavirus, respiratory symptoms were dominated by signs of upper respiratory tract involvement.

EP448 / #481

Topic: AS13. COVID 19 and MIS-C

COVID-19 IN ADMITTED PEDIATRIC PATIENTS – HOW TO SCREEN?

E-Posters

E-POSTER VIEWING

Giuliana Pucarelli, Marianna Venceslau, Thalita Abreu, Ana Cristina Frota, Maria Angelica Guimaraes, Fernanda Queiroz, Thiago Anchoreta, Catherine Cordeiro, Terezinha Marta Castineiras, Regina Rocha, [Cristina Hofer](#)
Universidade Federal do Rio de Janeiro, Infectious Diseases, Rio de Janeiro, Brazil

Backgrounds: The diagnosis of COVID-19 in the pediatric population still poses a challenge but nevertheless it is necessary when admitting a patient to avoid possible nosocomial outbreaks. Since a screening test at admission is not always available, and in most lower income countries, the pediatric wards do not have private rooms, a screening tool, considering history and basic laboratory tests must be pursued. In this study we aimed to compare the epidemiological/clinical/laboratory manifestations between children who tested positive and negative for SARS-CoV-2.

Methods: cohort study, with children admitted to the hospital with diagnosis of upper-airway infection, pneumonia, bronchiolitis, fever with rash, diarrhea, or encephalitis which were tested with nasopharyngeal swab for qRT-PCR for COVID-19. We compared clinical and laboratorial manifestations between children COVID-19 positive and negative using logistic regression.

Results: A total of 533 patients were recruited from April 14, 2020 to April 30, 2021. The median age was 44 months (ranging from 1 to 192), 286 were male (55%), 329 (65%) had previous comorbidities and 31 (15%) use immunosuppressive drugs. 105 (20%) were COVID positive, In the multivariate analysis older children (OR=1.08 – 95%CI= 1.02-1.14), with lower white blood cells at admission (OR=0.98 – 95%CI= 0,98-1.00), and whose domiciliary contact is suspect to have COVID-19 (OR=1,60 – 95%CI= 1,02-2,60), presented higher chance to be infected with SARS-COV-2.

Conclusions/Learning Points: The epidemiological history of domiciliary contact with suspected COVID-19 infected member should be used in the case definition with other clinical variables when the PCR/antigen test results are not promptly available at patient admission, as a screening tool for SARS-COV-2.

EP449 / #1167

Topic: AS13. COVID 19 and MIS-C

SEVERE PNEUMONIA AND SEPTICEMIA DUE TO MRSA ON A CHILD WITH COVID-19

E-Posters

E-POSTER VIEWING

Dominicus Husada¹, Vininsia Mesang², Leny Kartina², Dwiyantri Puspitasari², Parwati Basuki², Ismoedijanto Moedjito², Retno Setyoningrum², Arda Pratama², Rika Hapsari²
¹Faculty of Medicine Universitas Airlangga / Dr. Soetomo Hospital, Child Health, Surabaya, Indonesia, ²Airlangga University / Dr Soetomo Hospital, Child Health, Surabaya, Indonesia

Title of Case: Severe Pneumonia and Septicemia due to MRSA on a Child with Covid-19

Background: During the pandemic of Covid-19, many cases were hospitalized with multiple infections. Any additional infections would worsen the patient and should be treated seriously.

Case Presentation Summary: A previously healthy 11 years old boy was referred with a chief complaint of shortness of breath accompanied by a remittent high-grade fever which was gradually worsened following antibiotic administration from eight days before hospital admission. He previously had been diagnosed with Covid-19 pneumonia. The Covid-19 was resolved following five days of antiviral administration; however, the clinical symptom worsened. He had a history of contact with his asymptomatic covid-19 playmate one week before. General examination revealed a weak child, fever, tachycardia, tachypnea, and desaturation. Physical examination showed asymmetrical hemithorax expansion with crackles on both lungs and decreased vesicular breath sound, mainly on the right lung. The first laboratory examination from the previous hospital revealed dominant neutrophil leukocytosis and elevated level of CRP and D-dimer. The blood culture revealed methicillin resistance Staphylococcal aureus (MRSA). The chest radiography showed rapid, widespread pneumonia, bilateral pleural effusions, and multiple cavitory lesions. The pleural fluid analysis revealed exudative and serious visible fluid. The patient never had a history of chronic lung disease or other chronic diseases. The immunization history was complete. Chest tube water seal drainage was inserted. Vancomycin and enoxaparin were started. The patient improved, and the second blood culture after seven days was negative. The patient was sent home on day sixteenth with a good condition.

Learning Points/Discussion: Dual infection create big problem during the Covid-19 pandemic. MRSA infection is a serious disease. The management effort should consider both infections in order to get a better outcome.

EP451 / #825

Topic: AS13. COVID 19 and MIS-C

COVID 19 AND ERYTHEMA MULTIFORME ASSOCIATED WITH HERPESVIRUS

E-Posters

E-POSTER VIEWING

Malvina Javakhadze¹, Davit Nikolaishvili², Manana Kachlishvili²

¹Tbilisi State Medical University, Infectious Diseases, Tbilisi, Georgia, ²Acad.V.Bochorishvili clinic, Pediatric, Tbilisi, Georgia

Title of Case:



COVID 19 and Erythema Multiforme Associate With Herpesvirus



Background: Skin manifestations are not rare during covid 19 infection and their frequencies vary between 0.2-20.4%, according to different authors vary as the type of rash elements as well frequencies (1,2). There have also been described few cases of erythema multiforme like lesions (3,4).

Case Presentation Summary:



More than 1400 SARS COV 2 positive patients of the age group <18 years have been treated in the department of pediatrics at Acad. V. Bochorishvili Clinic. In 4 cases we observed erythema multiforme like lesions. Patients ages varied between 6-12 years. Three of them developed skin lesions and in one case oral lesions had been observed. In all cases, the lesions developed in the first days of illness, acutely. The reason for hospital admission was the skin lesions and only after those patients were diagnosed with COVID 19. In each case PCR test for SARS COV 2 was positive and HSV1 PCR and anti-HSV IgM were positive too. Three of them noted that they had experienced mild rash previously but the investigation had never been done. One patient developed the rash for the first time and it was associated with COVID 19. All the patients underwent symptomatic care and were discharged from the hospital without complications.

Learning Points/Discussion:



While discussing cases we admit that erythema multiforme is associated with herpesvirus and it is a chronic condition and it can reactivate due to different reasons. In the aforementioned cases, the activation happened due to covid 19 and manifested severely. But it is also not excluded the reason for erythema multiforme to be SARS-COV-2.

EP452 / #784

Topic: AS13. COVID 19 and MIS-C

ASSOCIATION BETWEEN MATERNAL AND NEONATAL SARS-COV-2 SPECIFIC ANTIBODIES AT BIRTH

E-Posters

E-POSTER VIEWING

Neli Jekova¹, Stanislava Nikolova², Jordanka Krasteva-Dimitrova³, Margarita Todorova - Baramova³

¹Medical University, Obstetrics And Gynecology, Sofia, Bulgaria, ²University hospital of Obstetrics and Gynecology, Neonatology, Sofia, Bulgaria, ³University hospital of Obstetrics and Gynecology, Clinical Laboratory, Sofia, Bulgaria

Backgrounds: Transplacentally acquired antibodies are an essential element of neonatal immunity. Understanding the maternal immune responses against severe acute respiratory syndrome coronavirus-2 (SARS- CoV-2) infection and placental antibody transfer is important for potential neonatal protection from coronavirus-2 disease. The aim of study was to assess the association between maternal and neonatal SARS- CoV-2 specific antibody concentrations and transplacental transfer ratios.

Methods: IgG and IgM antibodies to the receptor-binding domain of the SARS-CoV-2 spike protein were measured by immune-fluorescent assay in blood sera of the examined newborn infants and their mothers in the first 48 hours after delivery. Antibody concentrations and transplacental transfer ratios were analyzed in combination with demographic and clinical data.

Results: A total of 1302 women delivered at the Universityhospital between December 31.2020 and May 31, 2021. Forty-five mothers had SARS-CoV-19 disease during pregnancy and 15 of them were sick in the perinatal period. SARS-CoV-2 IgG and/or IgM antibodies were detected in 32 of 1200 women (2,5%) at the time of delivery and IgG was found in blood from 23 of 45 newborns (51%). IgM was not detected in any blood specimen, and antibodies were not found in any infant born to a seronegative mother. None of the infants born to mothers with SARS-CoV-2 in the perinatal period was seropositive. Neonatal IgG concentrations were positively correlated with maternal IgG concentrations ($r = 0.73$; $P < .001$). Placental transfer ratios more than 1.0 were observed among women with asymptomatic SARS-CoV-2 infection as well as those with mild, moderate, and severe coronavirus-2 disease. Transfer ratios increased with increasing time between onset of maternal infection and delivery.

Conclusions/Learning Points: Our findings demonstrate the potential for maternally derived SARS-CoV-2 specific antibodies to provide neonatal protection from coronavirus-2 disease.

EP453 / #1334

Topic: AS13. COVID 19 and MIS-C

PERICARDITIS AS LATE COMPLICATION OF COVID-19 IN A 4 YEAR OLD

E-Posters

E-POSTER VIEWING

Gheorghita Jugulete, Andreea Panciu, Oana Petrescu, Mihai Lazar, Madalina Merisescu
National Institute for Infectious Diseases Matei Bals, Pediatric Infectious Diseases, Bucharest, Romania

Title of Case: Pericarditis as late complication of COVID-19 in a 4 year old

Background: Pericarditis is one of the most severe complications that can occur in a child with COVID-19

Case Presentation Summary: We present the case of a previously healthy 4 years old female who presents to the emergency room 4 weeks after a mild form of COVID-19 (confirmed by positive RT-PCR SARS-COV2) and subsequent remission of initial symptoms, for newly developed symptoms consisting of chest pressure and fatigue. Laboratory evaluation included leukocytosis (9,93 K/ μ L) with lymphocytosis (3,59 K/ μ L) , thrombocytosis (532 K/mm³), high CK-MB (78 U/L), but normal troponin (0,03 ng/ml) and B-type natriuretic peptide (BNP) (71 ng/L), ferritin (14,8 ng/ml), erythrocyte sedimentation rate (ESR) 14,8, C reactive protein (CRP)0,16 mg/dL, fibrinogen 223 mg/dl. PCR panel for respiratory viruses including SARS-COV2 was negative. Serology tests for Coxsackie, ECHO, Epstein-Barr virus, cytomegalovirus, human herpesvirus (HHV) 6, adenovirus, mycoplasma, chlamydia, and HIV were negative. COVID-19 specific antibodies were positive. The electrocardiogram (ECG) revealed a sinus rhythm of 85 b/min, with no abnormalities. A chest X-ray showed an enlarged cardiac silhouette. The echocardiography showed a < 1 cm circumferential pericardial effusion. The patient received 14 days of nonsteroidal anti-inflammatory drugs (NSAIDs) treatment with remission of symptoms, with normal echocardiography at 1-month evaluation.

Learning Points/Discussion: The cardiovascular system is recognized as a target of the SARS-CoV-2 infection. It seems that COVID-19 pericarditis may have similar clinical features to other viral cardiotropic infections. There are no established guidelines for the management of pericarditis secondary to COVID-19, especially in the pediatric population. Our patient had a rapid clinical response to standard therapy for standard pericarditis.

EP454 / #1575

Topic: AS13. COVID 19 and MIS-C

TRANSIENT SPLENIAL LESION , COULD BE A SIGN OF NEUROMIS-C?

E-Posters

E-POSTER VIEWING

Mahmut Kizil¹, Seray Guler², Yalçın Kara¹, Ersin Yüksel³, Coşkun Yazar⁴, Tercan Us⁵, Ömer Kılıç⁶, Ener Cagri Dinleyici⁷

¹Eskişehir Osmangazi University, Pediatric Infectious, Eskişehir, Turkey, ²Eskişehir osmangazi university, Pediatrics, eskişehir, Turkey, ³Eskişehir osmangazi university, Pediatric Neurology, eskişehir, Turkey, ⁴Eskişehir osmangazi university, Pediatric Neurology, Eskişehir, Turkey, ⁵Eskişehir Osmangazi Medical University, Microbiology, Eskişehir, Turkey, ⁶Eskişehir Osmangazi Medical University, Pediatric Infectious, Eskişehir, Turkey, ⁷Eskişehir Osmangazi Medical University, Pediatric Intensive Care, Eskişehir, Turkey

Title of Case: Transient splenial lesion , could be a sign of neuroMIS-C?

Background: Multisystem inflammatory syndrome (MIS-C) is a pediatric hyperinflammation disorder caused by SARS-CoV-2. Today it is known that MIS-C has a large burden of clinical presentation. The range of neurologic symptoms associated with COVID-19 and MIS-C in children and adolescents was broad and varied by age. We present a MIS-C case with neurological involvement and transient splenial lesion was detected in cranial MRI.

Case Presentation Summary: The child presents to the emergency department due to the addition of exanthema in the complaints of fever, vomiting and diarrhea that started 5 days before the admission. In first examination, it was observed that he was lethargic, dehydrated, conjunctivitis in the eyes, redness on the lips, and urticarial rash on the body. In laboratory, leucocyte 10600/mm³, lymphocyte 1300/mm³, eritrocyte sedimentation rate 59 mm/h, pro-BNP:6700pg/mL, procalcitonin:69ng/mL, ferritin 650 ng/nL, echocardiography was normal. Blood and urine cultere was negative. For MIS-C, IVIG and steroid treatment was given but in first hour of infusion of IVIG, patient began to talk nonsense and began to see objects that were not on the Wall. After this transient symptom, cranial MRI was showed transient splenial lesion on root of corpus callosum. After IVIG and steroid treatment, all inflamatory findings and clinical symptom get normal.

Learning Points/Discussion: Transient splenial lesions (TSL) of the corpus callosum are uncommon radiologic findings that are seen in a number of clinical conditions with varied etiologies. These lesions are usually incidentally detected when imaging is done for encephalopathy/encephalitis or seizures, and the actual incidence might be more than what reports indicate. We report a MIS-C case presented with neurological findings and splenial lesion was detected on MRI.

EP455 / #1272

Topic: AS13. COVID 19 and MIS-C

DC/SDL

E-Posters

E-POSTER VIEWING

Anastasia Konidari, Aikaterini Mastrogiannopoulou, Vassiliki Mougiou, Christina Karastathi, Evangelia Kyritsa, Flora Tzifi, Afroditi Sakellaropoulou
Paidon Aglaia Kyriakou Children's Hospital, Beta Paediatric Department, Athens, Greece

Title of Case: SARS COVID 19 triggered severe cholangiopathy prompts urgent liver transplant listing in a PIFC3 patient.

Background: Case report of COVID19 triggered severe cholestatic liver injury in PFIC3. Children with chronic liver disease are at higher risk of developing decompensation of end stage liver disease during or after SARS CoV2 infection. Reference Nicasro et al, JPGN, Publish Ahead of Print DOI: 10.1097/MPG.0000000000003339 The Impact of SARS CoV2 on children with liver diseases: A Joint

European Society for PGHAN and Society of Paediatric Liver Transplantation Position Paper

Case Presentation Summary: A 9 year old diagnosed with combination of homozygous ABCB4 substitution mutation c.2064+3A>T and heterozygous missense mutation for NOTCH2 c.686C>A, presented with severe jaundice (total bilirubin 21,5 mg/dl), pruritus, petechiae and grade I encephalopathy. She had deranged clotting and hypersplenism, deteriorating synthetic liver function and concomitant rise in ammonia levels (up to 180 micromols/l). She showed partial response to supportive treatment with antibiotics, choleretics, vitamin K, albumin, platelet and fresh frozen plasma infusions over a period of three weeks. She remained stable but with irreversible cholestatic and synthetic liver injury without signs of improvement. The patient had been diagnosed with COVID 19 infection two months prior to this and had been briefly hospitalised with small rise in total bilirubin (up to 4,5 mg/dl). Her cholestasis however progressively deteriorated over two months; no other triggering factor could be held accountable for this persistent acute on chronic decompensation of liver function. Our patient was therefore listed for urgent liver transplant.

Learning Points/Discussion: This case report raises clinicians' awareness and adds to body of evidence of severe COVID 19 triggered liver injury, which may precipitate irreversible decompensation of synthetic liver function and severe cholangiopathy in children with progressive familial intrahepatic cholestasis.

EP456 / #1429

Topic: AS13. COVID 19 and MIS-C

CAPACITY MAPPING AND BUILDING FOR PEDIATRIC VACCINE TRIALS ACROSS EUROPE WITH VACCELERATE'S HARMONIZED ASSESSMENT TOOL

E-Posters

E-POSTER VIEWING

Ioannis Kopsidas¹, Sanne Hofstraat², Jon Salmanton-García³, Dimitra Kousi¹, Christos Argyropoulos⁴, Margot Hellemans⁵, Greet Hendrickx⁵, Catherine Isitt⁶, Lotte Jonker⁷, Salma Malik⁸, Christina Merakou¹, Paula Valle Simon⁹, Sophia Themistocleus⁴, Camilla Tøndel¹⁰, Theoklis Zaoutis¹, Oliver Cornely³, Patricia Bruijning-Verhagen⁷, Zoi Dorothea Pana⁴

¹Center for Clinical Epidemiology and Outcomes Research, Cleo, Athens, Greece, ²University Medical Center Utrecht, Julius Center For Health Sciences And Primary Care, Utrecht, Netherlands, ³University of Cologne, Faculty Of Medicine And University Hospital Cologne, Department I Of Internal Medicine, Excellence Center For Medical Mycology (ecmm), Cologne, Germany, ⁴European University Cyprus, School Of Medicine, Nicosia, Cyprus, ⁵University of Antwerp, Vaxinfectio, Centre For Evaluation Of Vaccination, Antwerp, Belgium, ⁶Karolinska University Hospital, Department Of Infectious Diseases, Solna, Sweden, ⁷UMC Utrecht, Julius Center For Health Sciences And Primary Care, Utrecht, Netherlands, ⁸European Clinical Research Infrastructure Network, Ecrin, Paris, France, ⁹La Paz University Hospital, Clinical Pharmacology Department, Madrid, Spain, ¹⁰Haukeland University Hospital, Department Of Clinical Medicine, Bergen, Norway

Backgrounds: VACCELERATE a clinical research network for the coordination and conduct of COVID-19 vaccine trials, funded by the European Commission for future pandemic preparedness (HERA Incubator). In this framework, the European Vaccine Trial Accelerator Platform (EUVAP) is providing a continuous Europe-wide harmonized mapping of clinical trial sites for conducting COVID-19 vaccine trials. Herewith, we focus on the current readiness status of the pediatric vaccine trial sites across Europe aiming to identify future targets for capacity building.

Methods: EUVAP provides an online accessible survey at www.euvap.eu. Participating sites were sent a feasibility questionnaire (July 2021) providing information about available infrastructure and resources, previous clinical trial experience, and regulatory approval conditions. A harmonized assessment tool was developed which evaluates pediatric site readiness. Answers are scored 1-4 points and are presented using a traffic light approach.

Results: In total 95 pediatric sites participated from 22 countries. The majority included University Hospitals (72, 75.8%). Seventy sites (73.7%) reported previous experience with pediatric clinical (non-vaccine) trials, of which most in Phase III (53, 79.1%), while only 16 (23.9%) in Phase I. Even less (48, 50.5%) reported experience with pediatric vaccine trials over the last 5 years, most of which were in Phase III (37, 77.1%) and only 6 (12.2%) in Phase I. Average readiness scores are shown in Figure 1. Fast track approval for COVID-19 vaccine studies was available in 56 (58.9%) sites. In almost 1/3 of the sites (30, 31.6%) institutional review board approval takes 30 days or less.

Figure 1 – Readiness score for pediatric vaccine trials – Average by country

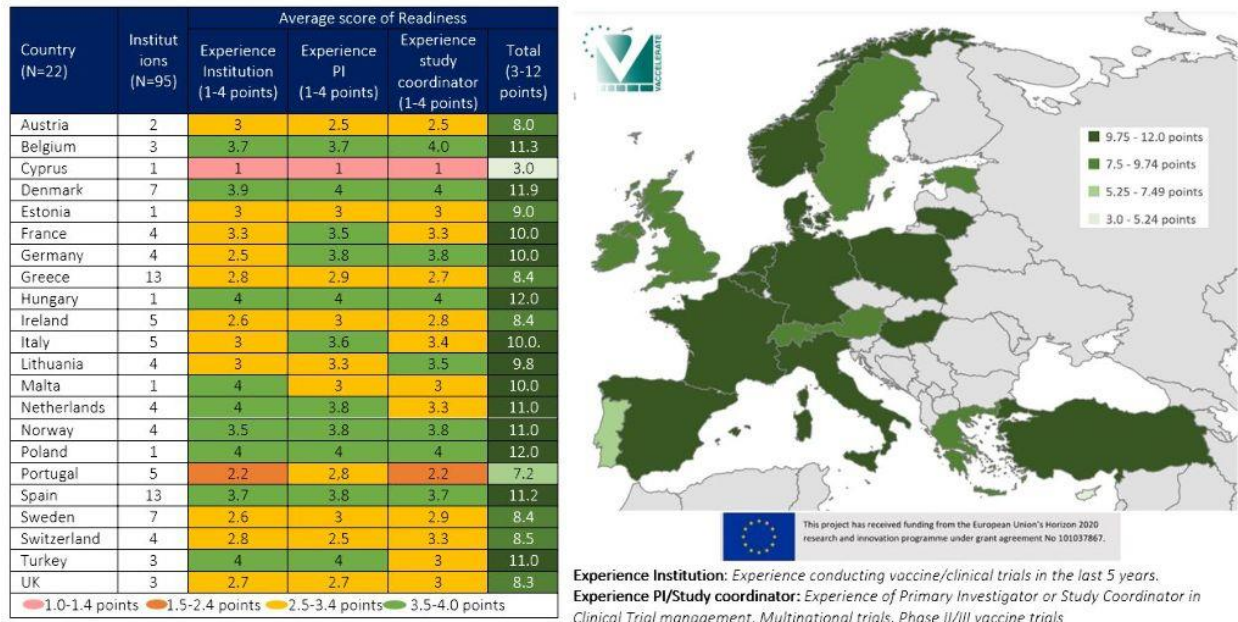

Conclusions/Learning Points: A significant variability in the current site readiness for pediatric vaccine trials across 22 countries was observed. EUVAP provides continuous identification of existing gaps with a standardized and harmonized assessment tool, and supports future improvement within the aims of VACCCELERATE.

EP457 / #829

Topic: AS13. COVID 19 and MIS-C

COVID-19 ASSOCIATED MYOCARDITIS IN PEDIATRIC PATIENT

E-Posters

E-POSTER VIEWING

Rebeka Kūma¹, Liene Čupāne², Gunta Laizāne², Rūta Kaķe²

¹Rīgas Stradiņš University, Faculty Of Medicine, Rīga, Latvia, ²Clinic of General Paediatrics, Rsu, Department Of Paediatrics, Riga, Latvia

Title of Case: COVID-19 associated myocarditis in pediatric patient

Background: Coronavirus disease -2019 is new viral infection disease, caused by severe acute respiratory syndrome coronavirus 2 (SARS-CoV-2). Most common clinical symptoms include fever, cough, sore throat, headache. Cardiovascular complications of COVID-19 have been reported in adult including myocarditis, however, less is known about the myocardial involvement in children. A 10-year-old boy with history of mild persistent asthma, without cardiovascular risk factors or previous history of cardiovascular disease presented to the emergency department with 6 days of cough, fever (up to 38.4 C), headache, tested positive on COVID-19. His vital signs were notable for tachycardia (heart rate of 138 b.p.m.), tachypnea (RR, 22 breaths/min). Physical examination was otherwise normal, no signs of pneumonia. During hospitalisation on day 5 of illness with elevation in cardiac markers were detected high-sensitivity troponin I 1458mg/L and N-terminal probrain natriuretic peptide 310 pg/mL. Search for other possible cardiotropic viral agents like influenza, Parvovirus B19, EBV IgM was negative. Cardiovascular magnetic resonance confirmed acute myocarditis- pericardial effusion of the left ventricle in the lower-lateral, lateral wall of the middle segments. Metoprololum was started. After 24 hospitalisation day patient was discharged with recommendations for follow-up next month.

Case Presentation Summary: The suspicion of myocarditis was based on specific diagnostic tool cardiovascular magnetic resonance and cardiac markers elevation. Endomyocardial biopsy could not be employed due to the urgency and young age of the patient.

Learning Points/Discussion: COVID-19 may result in cardiac injury through multiple potential mechanisms, including viral invasion of cardiomyocytes resulting in cellular damage. Mostly, myocarditis in children is attributable to viruses, such as myocarditis-enterovirus, herpes virus (Ebstein-Barr virus), and influenza A virus. This case report is the first known COVID-19 associated myocarditis in pediatric patient Latvia.

EP458 / #874

Topic: AS13. COVID 19 and MIS-C

SPONTANEOUS PNEUMOTHORAX IN CHILDREN WITH COVID-19. CASE REPORT.

E-Posters

E-POSTER VIEWING

Nataliia Kyrytsia, Sergiy Kramarov, Vitalii Yevtushenko, Iryna Seriakova, Valerii Shadrin, Tatiana Kaminska

BOGOMOLETS NATIONAL MEDICAL UNIVERSITY, Pediatric Infectious Diseases, Kyiv, Ukraine

Title of Case: SPONTANEOUS PNEUMOTHORAX IN CHILDREN WITH COVID-19

Background: Spontaneous pneumothorax is a rare complication of COVID-19 pneumonia. Isolated cases were described in pediatrics.

Case Presentation Summary: 4028 pediatric patients of Kyiv City Pediatric Infectious Hospital hospitalized with COVID-19 for 2020-2021 years there were 3 cases of spontaneous pneumothorax. We retrospectively analyzed those cases. All those patients were treated according to the guidelines and WHO/CDC recommendations. 8 years boy got to hospital on the 7th day of illness with complaints of fever, abdominal pain and diarrhea. From the 12th day there is a progress of respiratory disorders in form of decrease in saturation and increase in a cough. On the 35th day sharp deterioration takes place due to tense right-sided pneumothorax. Drainage is installed. In the following days condition progressively worsened due to manifestations of MOF and ended in death on the 38th day. 4 months boy got to hospital with impaired consciousness and breathing which were preceded by 4 days of minor manifestations of upper respiratory tract infection. No prior medical history. X-Ray showed bilateral lung involvement and left-sided pneumothorax. The chest cavity is drained, mechanical ventilation is carried out. In the next 7 days manifestations of RDS and MOF progressed to death. 3 months boy got to hospital from the 2nd day of illness with symptoms of moderate respiratory failure and received non-invasive respiratory support. From the 4th day condition worsened due to refractory shock. Sudden deterioration in respiratory function is admitted on the 9th day due to right-sided pneumothorax. From the 16th day, there was a positive dynamics with full recovery by the 30th day.

Learning Points/Discussion: Spontaneous pneumothorax can complicate the COVID-19 in children. It can occur at different stages of disease and is associated with poor outcomes.

EP459 / #69

Topic: AS13. COVID 19 and MIS-C

THE DIFFERENCE OF THE INFLAMMATORY MILIEU IN MIS-C AND SEVERE COVID-19

E-Posters

E-POSTER VIEWING

Sibel Laçinel Gürlevik¹, Yasemin Özsürekci¹, Erdal Sağ², Pembe Derin Oygur¹, Selman Kesici³, Ümmüşen Kaya Anca⁴, Müşerref Kasap Cüceoğlu⁴, Özge Başaran⁴, Sultan Göncü³, Jale Karakaya⁵, Ali Bülent Cengiz¹, Seza Özen⁴

¹Hacettepe University Faculty of Medicine, Pediatric Infectious Diseases, Ankara, Turkey, ²Ankara Training and Research Hospital, Pediatric Rheumatology, Ankara, Turkey, ³Hacettepe University Faculty of Medicine, Pediatric Intensive Care Unit, Ankara, Turkey, ⁴Hacettepe University Faculty of Medicine, Pediatric Rheumatology, Ankara, Turkey, ⁵Hacettepe University Faculty of Medicine, Department Of Biostatistics, Ankara, Turkey

Backgrounds: Coronavirus disease 19 (COVID-19) may have a severe course in children. MIS-C is the post-covid complication characterized by an exaggerated inflammation, observed in children. However, data on the underlying pathophysiology are sparse. We therefore aimed to assess the cytokine and chemokine profiles of children with MIS-C and compare these to life-threatening severe SARS-CoV-2 and healthy controls to shed light on disease pathophysiology

Methods: Samples of 31 children with MIS-C, 10 with severe/critical COVID19 and 11 healthy controls (HCs) were included. Cytokine and chemokine profiles were studied and compared in between groups.

Results: Most cytokines and chemokines related to IL-1 family and IFN- γ pathway (including IL-18 and MIG/CXCL9) and IL17A were significantly higher in the MIS-C group when compared to the severe/critical COVID19 group and healthy controls. IP-10/CXCL10 and IL-10 were higher in both MIS-C patients and severe/critical COVID-19 compared to HCs.

Conclusions/Learning Points: Our results suggest that IL-1 and IFN- γ pathways play an important role in the pathophysiology of MIS-C.

EP460 / #1162

Topic: AS13. COVID 19 and MIS-C

MULTISYSTEM INFLAMMATORY SYNDROME (MISC) IN A PEDIATRIC INTENSIVE CARE UNIT (PICU)

E-Posters

E-POSTER VIEWING

Anna Maria Spanaki¹, Fani Ladomenou², Theonymphi Tavladaki¹, Evaggelia Dardamani¹, Marianna Miliaraki¹, Efrosyni Vasilaki¹, Elisavet Geromarkaki¹, Stavroula Ilia¹

¹University Hospital of Heraklion, Crete, Picu, HERAKLION CRETE, Greece, ²Venizeleion General Hospital, Pediatrics, Heraklion, Greece

Backgrounds: COVID-19 infection is usually mild in children. However, a multisystem inflammatory syndrome (MISC) can happen, 4-6 weeks post infection mainly in school-age children. While uncommon it can be lifethreatening and intensive care treatment may be needed.

Methods: We present three children with MISC entered in our unit during 2020-21, a 7 bed multidisciplinary PICU in a tertiary University Hospital, where children and adolescents from all the southern part of our country are admitted. Characteristics, demographical, clinical profile, clinical course, laboratory results, duration of mechanical ventilation and hospitalization, therapy and outcome were recorded.

Results: All were girls, 6, 7 and 16 years old respectively and had no comorbidities except of autoimmunity in the 6 years old female's family. All reported a contact with a COVID-19 case, and the 16 years old girl had a recent (1 month before) self test positive for SARS-CoV-2 infection, without symptoms. None confirmed by RT-PCR and/or serology. All need inotropic and vasoactive support for severe cardiovascular compromise. Lymphocyte count, neutrophil count, C-reactive protein, procalcitonin, ferritin, d-Dimer and cardiac dysfunction markers were increased. Treatment included antibiotics, corticosteroids and IVIG and enoxaparin. Two needed invasive mechanical ventilation, the 7 years old girl for 23 days and the 6 years old for 5 days. Median length of PICU stay was 16 days (28,13,7 respectively) None death occurred All survived and quitted PICU in good clinical condition.

Conclusions/Learning Points: MISC represents a serious condition relating to Covid infection and propably a main cause of hospitalization or PICU admission. MIS-C can be a treatable condition with intensive care therapy. Long-term multidisciplinary follow-up may be necessary to ensure if chronic cardiac impairment or other dysfunctions remain. ΒΙΒΛΙΟΓΡΑΦΙΑ

<https://www.uptodate.com/contents/covid-19-multisystem-inflammatory-syndrome-in-children-mis-c-clinical-features-evaluation-and-diagnosis> World J Pediatr. 2022 Jan 4:1-8

EP461 / #708

Topic: AS13. COVID 19 and MIS-C

COMPARATIVE CHARACTERIZATION OF HUMAN ANTIBODY RESPONSE INDUCED BY BNT162B2 VACCINE VS WILD-TYPE INFECTION

E-Posters

E-POSTER VIEWING

Theano Lagousi¹, John Routsias², Ioanna Papadatou¹, Vassiliki Spoulou¹

¹Aghia Sophia Children's Hospital, Immunobiology And Vaccine Research Lab, athens, Greece, ²Athens Medical School, Department Of Microbiology, athens, Greece

Backgrounds: Despite the significant efficacy of Pfizer-BNT162b2 vaccine, the duration of the protection remains unknown. On the other hand, COVID-19 antibodies wane over time following natural infection. This study assessed humoral immune response to Pfizer-BNT162b2 vaccine in comparison to wild-type infection.

Methods: COVID-19 patients, followed-up for 5 months and individuals vaccinated with BNT162b2 vaccine, followed for >8 months were enrolled. Neutralizing (NAbs), anti-RBD and anti-S1 antibodies were assessed using ELISA assays. Urea dissociation experiments were also performed.

Results: Anti-RBD, anti-S1 and NAbs antibodies remained almost stable after the first month post disease onset, being detectable in >95% of the participants 5 months post disease onset. Anti-RBD, anti-S1 and NAbs antibodies peaked 1 month following the booster dose among vaccine recipients and declined significantly rapidly thereafter; albeit they were detected in >95% of the participants after 8 months. Anti-RBD antibodies among vaccinees were significantly higher compared to patients, at all time-points. Similar trends were recorded for anti-S1 and NAbs antibodies among the two groups, although anti-RBD antibodies were higher for vaccinees compared to anti-S1 antibodies at all time-points among both groups. The avidity of anti-RBD antibodies increased gradually over the 5-months period among patients, while the avidity of anti-RBDs significantly increased at 1 month post booster dose but significantly decreased thereafter among vaccinees.

Conclusions/Learning Points: Individuals who received BNT162b2 vaccine have distinct kinetics of antibody levels compared to patients who had been infected with the SARS-CoV-2. Vaccinated individuals exhibited higher initial levels but a much faster decrease of antibody titer compared to patients who had been infected, who showed a more gradual increase of antibody levels that remained almost stable over the study period. The avidity maturation was more robust among patients compared to vaccinees.

EP462 / #1426

Topic: AS13. COVID 19 and MIS-C

PAVING THE WAY TOWARDS PRECISION VACCINOLOGY: THE PARADIGM OF MYOCARDITIS AFTER COVID-19 VACCINATION

E-Posters

E-POSTER VIEWING

Theano Lagousi¹, Petros Strempas², Elena Chatzikalil², Ioanna Papadatou¹, Vassiliki Spoulou³
¹Aghia Sophia Children's Hospital, Immunobiology And Vaccine Research Lab, athens, Greece, ²Athens Medical School, Athens Medical School, athens, Greece, ³Aghia Sophia Children's Hospital, Immunobiology And Vaccine Research Lab, Athens, Greece

Backgrounds: Increased cases of myocarditis have been reported following mRNA-COVID-19 vaccination, mainly among adolescents and young adults. We review data on myocarditis epidemiology among such population following mRNA-COVID-19 vaccination and assess potential mechanisms.

Methods: A search via PUBMED using the terms "myocarditis, young adults, adolescents, mRNA-vaccine, COVID-19, SARS-COV-2" and Vaccine Adverse Reporting System (VAERS) and EudraVigilance-European database of suspected adverse drug reaction reports was conducted.

Results: The incidence in children 12-15 years ranges from 3.99/100,000 to 10/100,000 for males and from 0.39/100,000 to 2.5/100,000 for females due to genetic differences and/or standard reporting procedures. In young males 16-29 years of age the incidence was more than 10/100,000 (compared to 0.3/100,000 among females of the same age and less than 1/100,000 in the general population). Most cases typically onset within several days after vaccination, mainly after the second dose (70% among boys aged 6-17 years compared to 60% among general population). The clinical course is mainly benign and rapidly self-limiting. The mechanisms associated with post mRNA-vaccine myocarditis are age-related differences in mRNA immune hyperimmunity, development of autoantibodies and hormonal differences. mRNA platform may activate innate immunity, mainly driven by IFN-gamma and TNF-alpha, predominantly among young males. Molecular mimicry between spike-antigen and cardiac self-antigens, is another possible mechanism. Finally, hormone signalling differences might lead to post-vaccine myocarditis. Testosterone can inhibit anti-inflammatory immune cells, promoting an aggressive T-helper-1 immune response. Immune-genetic background may affect these mechanisms.

Conclusions/Learning Points: The predominance of post-vaccine myocarditis among young males is a robust paradigm paving the way towards precision vaccinology. Instead of developing vaccines for large populations, even during a pandemic, focus should be shifted to the distinct characteristics of each vaccinee, i.e. prior exposure, priming, immune status, affecting vaccine safety and efficacy.

EP463 / #1266

Topic: AS13. COVID 19 and MIS-C

SMELL DYSFUNCTION IN CHILDREN DIAGNOSED WITH COVID-19. AN UNDERESTIMATED PROBLEM.

E-Posters

E-POSTER VIEWING

Dawid Lewandowski, Kacper Toczyłowski, Artur Sulik

Medical University of Białystok, Department Of Pediatric Infectious Diseases, Białystok, Poland

Backgrounds: From the beginning of the COVID-19 pandemic, it was known that the disease is associated with olfactory disfunction. Unlike adults, children rarely report loss of smell in the course of COVID-19. In our study we evaluated the occurrence of olfactory loss in children hospitalized with the SARS-CoV-2 infection.

Methods: 66 children (aged 7-17 years) who tested positive for COVID-19 were included in the study. The Polish version of the 40-odorant University of Pennsylvania Smell Identification Test (UPSIT) was used in this study. The UPSIT is a standardized multiple-choice scratch-and-sniff test, comprised of four booklets, each containing 10 microencapsuled odors. For each strip, participants are required to identify the correct smell from a forced choice of 4 possible answers. The results are compared with normative age- and sex-specific thresholds for olfactory dysfunction.

Results: 64 (97%) of the 66 patients exhibited some smell dysfunction. 44% patients were anosmic, 26% severely microsmic, 18% moderately microsmic, 4.5% mildly microsmic, and only 3% normosmic (4.5% were categorized as “cheaters”). 86% of children were unaware of their chemosensory loss. For 18 of the 40 test items, the identification rate was >50%. Four weeks after the discharge, 10 patients were retested. The remaining 54 stated that olfaction significantly improved and did not consent for the second test. Of those 10, smell dysfunction was still present in 2 children.

Conclusions/Learning Points: Despite children diagnosed with COVID-19 rarely report olfactory impairment, most of them have wide range of smell dysfunctions. In majority smell disturbances are transient. Knowing that smell dysfunction classification is based on normative age- and sex-specific thresholds, we presume that results we received arise from actual smell disfunction rather than from unfamiliarity of smells presented in the UPSIT test.

EP464 / #1438

Topic: AS13. COVID 19 and MIS-C

CEREBROSPINAL PLEOCYTOSIS IN CHILDREN HOSPITALIZED WITH MULTISYSTEM INFLAMMATORY SYNDROME (MIS-C): A CASE SERIES

E-Posters

E-POSTER VIEWING

Dawid Lewandowski, Kacper Toczyłowski, Artur Sulik

Medical University of Białystok, Department Of Pediatric Infectious Diseases, Białystok, Poland

Title of Case: Cerebrospinal pleocytosis in children hospitalized with multisystem inflammatory syndrome (MIS-C): a case series.

Background: Symptoms of MIS-C including fever, conjunctivitis, lymphadenopathy, mucosal changes classically resemble Kawasaki disease. In some cases neurological symptoms are the most prominent, prompting a screen for neuroinfections, including CSF analysis. Objective of this study is to discuss the frequency and legitimacy of lumbar puncture in patients diagnosed with MIS-C.

Case Presentation Summary: Altogether 34 children with MIS-C were admitted to the Teaching Children's Hospital in Białystok between November'20 and December'21. We report a case series of 10 patients diagnosed with MIS-C who initially presented symptoms suggesting neuroinfection (7 males and 3 females; mean age 7 years). Clinical and laboratory data were collected from all children and CSF samples were obtained from 5 patients. Out of 10 patients 7 had some neurological involvement, 5 underwent lumbar puncture, 1 had CSF pleocytosis. No pathogens were detected in CSF samples. Common symptoms prompting a screen for CNS infection were fever (10/10), neck stiffness (8/10), headache (7/10) and vomiting (5/10). 5 of 8 patients with neck stiffness had distinct cervical lymphadenopathy. All children had laboratory findings consistent with MIS-C and fulfilled the WHO criteria for diagnosing MIS-C.

Learning Points/Discussion: Neurological symptoms of MIS-C may be misdiagnosed for neuroinfection, what extends the diagnostic process and leads to unnecessary procedures. CSF pleocytosis seems to be an uncommon finding in children with MIS-C, however only few patients had CSF analysis. Cervical lymphadenopathy - a common symptom of MIS-C, often imitates neck stiffness, being mistaken for a sign of neuroinfection, especially accompanied by high fever and headache. Awareness of symptoms and laboratory findings of MIS-C is crucial in making the right diagnosis and avoiding heavy invasive procedures, like lumbar puncture.

EP465 / #1399

Topic: AS13. COVID 19 and MIS-C

LESSONS LEARNT FROM THE RAPID IMPLEMENTATION OF REUSABLE PERSONAL PROTECTIVE EQUIPMENT FOR COVID-19 IN MALAWI

E-Posters

E-POSTER VIEWING

David Garley¹, Fumbani Limani¹, Derek Cocker¹, Priyanka Patel¹, Pratiksha Patel¹, Stephen Gordon¹, Mulinda Nyirenda¹, Luis Gadama², Queen Dube¹, Feggie Bodole¹, Kwazizira Samson Mndolo¹, Kelvin Mponda¹, Bridget Freyne³

¹Malawi-Liverpool Wellcome Trust, Id, Blantyre, Malawi, ²Kamuzu University of Health Sciences, Department Of Obstetrics, Blantyre, Malawi, ³Malawi Liverpool Wellcome Trust, Malawi Liverpool Wellcome Trust, Blantyre, Malawi

Backgrounds: The SARS-CoV-2 pandemic has challenged health systems and healthcare workers worldwide. Access to personal protective equipment (PPE) is essential to mitigate the risk of excess morbidity and mortality in healthcare providers. We describe the successful development and implementation of a reusable PPE system in the paediatric department of a tertiary referral hospital in Malawi.

Methods: This was a pilot implementation study which measured coverage, fidelity, acceptability, and cost-effectiveness of the reusable PPE system. The coverage and fidelity of the system were measured through observational audit. We describe in detail the development of reusable gowns and the system for sterilisation, deployment and scale-up in our setting.

Results: Benefits of the system included increased coverage, decreased cost and reduced waste. During the 8-week implementation phase gown usage was at 4,900 units per week. The cost to provide this with disposable gowns would have been £52,773, compared to £1813 via reusable gowns, representing an 8-week cost saving of £50,960. Implementation challenges included healthcare worker perceptions around the safety of cotton gowns, the need to plan for surge capacity and the need for ongoing training of laundry staff in safety and hygiene procedures.

Conclusions/Learning Points: The implementation of a reusable cotton gown service is feasible, acceptable, and cost-effective in tertiary centres providing specialist COVID-19 in LMICs. This innovation could be expanded beyond low-income settings.

EP466 / #1933

Topic: AS13. COVID 19 and MIS-C

DESCRIPTION OF TWO CASES OF CONFIRMED SARS-COV-2 REINFECTION IN CHILDREN

E-Posters

E-POSTER VIEWING

Núria López Segura, Julia Candel Pau, Judith Marcé Igual, Julieta Camarasa De Masdevall, Amaia Bilbao Garitagoitia
Hospital del Mar, Pediatrics Department, barcelona, Spain

Title of Case: DESCRIPTION OF TWO CASES OF CONFIRMED SARS-CoV-2 REINFECTION IN CHILDREN

Background: Prevalence of SARS-CoV-2 reinfection was supposed to be rare (<1%), due to immune escape variants it may be increasingly common. SARS-CoV-2 infection in children is usually mild, so it is likely that reinfection do not cause relevant problems. We describe two cases of reinfection in children.

Case Presentation Summary: A healthy 9-year-old girl, presented with 4 episodes of SARS-CoV-2 infection, confirmed by RT-PCR in October 2020, February 2021 (genome sequencing: Alpha variant), June 2021 (genome sequencing: Delta variant) and January 2022. She had received first dose of Comirnaty 7 days before last episode. Symptoms were generally mild (first episode: fever and sore throat, second: headache and cough, fourth: headache, rhinorrhea, malaise, abdominal pain). On the third episode she required ruling out appendicitis at the emergency department (she had fever, sore throat, abdominal pain and vomiting, C-reactive protein 10 mg/dL). She recovered well after all episodes except for the last one. She has persistent headache after 8 weeks, although it is improving. A healthy 10-year-old girl presented within 5 weeks with 2 episodes of SARS-CoV-2 infection confirmed by RT-PCR, on 21st December 2021 (genome sequencing: Delta variant) and 28th January 2022 (genome sequencing: Omicron variant). She had received first dose of Comirnaty 4 days before the first episode. Symptoms were mild (headache, sore throat, fatigue, plus cough and rhinorrhea in last episode). She recovered well.

Learning Points/Discussion: SARS-CoV-2 reinfection can be missed if it occurs after a short time (<90 days) or if the patient has mild or no symptoms. Genome sequencing is not usually available for confirmation. Although reinfection seems to be mild in children, it is important to monitor new variants for potential complications.

EP467 / #1312

Topic: AS13. COVID 19 and MIS-C

RAPID ANTIGEN TEST FOR DIAGNOSIS OF SARS-COV2 INFECTION IN THE PAEDIATRIC EMERGENCY DEPARTMENT OF A TERTIARY HOSPITAL

E-Posters

E-POSTER VIEWING

Magdalini Louka¹, Sofia Vassiliu¹, Stamatina Eleftheria Angeli², Athanasios Michos¹

¹“Aghia Sophia” Children’s Hospital, Division Of Infectious Diseases, First Department Of Pediatrics, Medical School, National And Kapodistrian University Of Athens, Athens, Greece, ²“Aghia Sophia” Children’s Hospital, Athens, Greece, Emergency Department, Athens, Greece

Backgrounds: Background: Early diagnosis of SARS-CoV-2 with rapid antigen test (RADT) is essential for the management of the infected children and for limiting the spread of the virus in the hospital and the community.

Methods: We performed an observational study at the major tertiary Greek pediatric Hospital "Aghia Sophia" Children’s hospital which included all the children with COVID-19-related symptoms presented to the emergency department (ED) from 1/1/2021-31/12/2021 and tested with RADT. Specimens for the detection were collected from the upper respiratory tract (nasopharyngeal swab). Analysis of the study samples was divided into four 3-month periods; January-March 2021, April-June 2021, July-September 2021, October-December 2021.

Results: Overall, n=9259 children were tested. Among them, n= 935 children detected positive for SARS-CoV-2, 420 females (45.5%) and 509 males (54.5%). 28,2% of children were <1 year and 47.4% of them <4 years old. In all four study periods the overall positivity rate of RADT was 10.09% of the total samples tested [Jan-Mar: 125/1186 (10.5%), Apr-Jun: 213/2094 (10.2%), Jul-Sep: 293/2815 (10.4%), Oct-Dec: 289/3164 (9.1%)]. Fever and cough were the most common clinical presentation. N=387 children (41.3%) with positive RADT were admitted to the COVID department and n=537 (57.4%) did not require hospitalization.

Conclusions/Learning Points: Conclusions: Although the incidence of COVID-19 infection in children increased in the community through the study period, the positivity rate of the symptomatic children presented to the ED was relatively stable, possibly due to different criteria of testing. Detection of SARS-CoV-2 infections among children is important for tracking the evolution of SARS-CoV-2 pandemic.

THE EPIDEMIOLOGY OF MULTISYSTEM INFLAMMATORY SYNDROME IN CHILDREN (MIS-C) IN CANADA

E-Posters
E-POSTER VIEWING

Robert Mactavish¹, Anita Li¹, Marina Salvadori², Meghan Lavery¹

¹Public Health Agency of Canada, Vaccine Preventable Diseases, Ottawa, Canada, ²Public Health Agency of Canada, N/a, Ottawa, Canada

Backgrounds: Periods of increased COVID-19 cases have been temporally linked with a subsequent increased incidence of multisystem inflammatory syndrome in children (MIS-C), a post-viral inflammatory syndrome resulting in fever, vomiting, myocarditis, and other inflammatory symptoms. The objective of this study was to describe the epidemiology of MIS-C in Canada since the start of the COVID-19 pandemic.

Methods: Cases reported nationally from March 11, 2020 to December 25, 2021 were analyzed. The temporal distribution and descriptive statistics of MIS-C were assessed, and the age distribution of MIS-C cases before and following widespread childhood vaccination was compared.

Results: 318 MIS-C cases were reported, including 160 COVID-19 positive and 17 epidemiologically linked cases. MIS-C was significantly more likely to occur in males than females (59% of cases, 95% CI: 54-65%). Following the widespread vaccination of children aged 12-18, the proportion of cases aged 12-18 decreased from 18.3% to 11.3%, however not significantly (difference of 7.0%, 95% CI: -3.2, 17.3). The temporal trend of MIS-C aligned with the incidence rate time trend of COVID-19 in children, with a two to six-week lag.

Figure 1. Number of MIS-C cases by epidemiological week of symptom onset compared with COVID-19 cases (N=308)

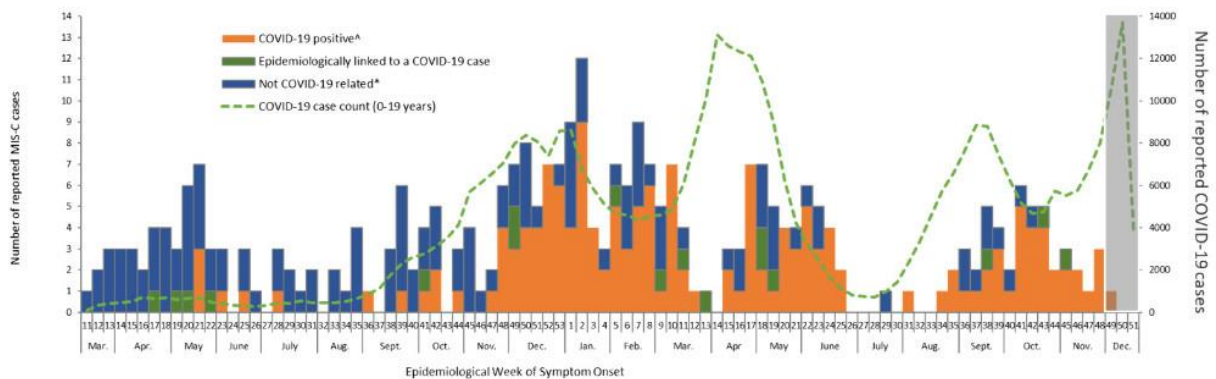

* No evidence of SARS-CoV-2 infection

^ COVID-19 positive via RT-PCR, antigen or serology test

Shaded area: Incomplete COVID-19 national reporting.

Conclusions/Learning Points: The temporal trend of MIS-C in Canada supports previous literature describing MIS-C as a delayed immunologic reaction to COVID-19. As MIS-C is a severe syndrome with a 99% hospitalization and 37% intensive unit care admission rate in Canada, ongoing MIS-C surveillance is crucial to monitor MIS-C case trends during the COVID-19 pandemic and endemic state.

HUMORAL IMMUNE RESPONSES TO DIFFERENT COVID-19 VACCINE PLATFORMS IN PREGNANCY

E-Posters
E-POSTER VIEWING

Larissa De Brabandere¹, Louise De Weerd¹, Eline Tommelein², An Vercoutere³, Nicolas Dauby^{4,5}, Kevin Ariën⁶, Isabelle Desombere⁷, Elke Leuridan¹, Arnaud Marchant⁵, Kirsten Maertens¹

¹University of Antwerp, Centre For The Evaluation Of Vaccination, Vaccine & Infectious Diseases Institute, Wilrijk, Belgium, ²Vrije Universiteit Brussel, Department Of Pharmaceutical Sciences, Faculty Of Medicine And Pharmacy, Brussel, Belgium, ³Université Libre de Bruxelles, Department Of Obstetrics And Gynaecology, Cliniques Universitaires De Bruxelles, Hôpital Erasme, Bruxelles, Belgium, ⁴Université Libre de Bruxelles, Department Of Infectious Diseases, Chu Saint-pierre, Bruxelles, Belgium, ⁵Université Libre de Bruxelles, Institute For Medical Immunology, Charleroi, Belgium, ⁶Institute of Tropical Medicine Antwerp, Virology Unit, Biomedical Sciences, Antwerp, Belgium, ⁷Sciensano, Sd Infectious Diseases In Humans, Brussels, Belgium

Backgrounds: Pregnant women are a priority group for COVID-19 vaccination because of their increased risk for COVID-19 related complications. Our study compared humoral immune responses to different COVID-19 vaccine platforms in pregnant women.

Methods: In a prospective observational cohort study, pregnant women were vaccinated with 2 doses of either the adenoviral vector vaccine (AVV) ChAdOx1 nCoV-19 (Vaxzevria, AstraZeneca, Oxford, UK) (N=17), the messenger RNA vaccine (mRNAV) BNT162b2 (Pfizer-BioNTech) (N=32) or the mRNAV mRNA-1273 (Moderna) (N=5). SARS-CoV-2 Spike protein receptor binding domain (RBD) IgG, neutralizing antibodies (NT50 Wuhan and Delta type) and avidity of the RBD IgG antibodies were assessed at different timepoints before and after COVID-19 vaccination.

Results: An increase in RBD IgG and neutralizing antibodies was observed after both AVV and mRNA vaccination. Women receiving mRNAVs reached the highest RBD IgG antibody Geometric Mean Concentration (GMC) at day 7 after the second dose whereas for women receiving the AVVs, the highest GMC was observed at day 28 after the second vaccine dose. mRNAV recipients showed significantly higher GMC's for all measured parameters at day 28 after the second vaccine dose compared to AVV recipients.

| TIMEPOINTS | D1_DAY00 | | D1_DAY49-56 | | D2_DAY00 | | D2_DAY07 | | D2_DAY28 | |
|--|------------------|-----------------------------------|----------------------------|-------------|----------------------|------------------------|------------------------|---------------------------|-------------------------------------|--------------------------------------|
| | AVV (N=17) | mRNA (N=37) | AVV (N=17) | mRNA (N=37) | AVV (N=17) | mRNA (N=37) | AVV (N=17) | mRNA (N=37) | AVV (N=17) | mRNA (N=37) |
| Not measured | N=0 | N=0 | N=0 | | N=1 | N=1 | N=0 | N=0 | N=1 | N=4 |
| RBD IgG (BAU/mL) GMC (95%CI) | 326 ^a | 21.1 ^{tb} (10.8-41.3) | 98.7 (56.3-173.0) | NA NA | 69.3 (32.5-147.9) | 419.0 (286.7-612.4) | 195.0 (113.8-334.1) | 3365.7 (2642.8-4286.2) | 312.6 (214.4-455.6) | 2610.0 (2042.7-3335.0) |
| Not measured | N=0 | N=1 | | | | | | | N=0 | N=3 |
| Neutralizing antibodies NT50 Wuhan GMC (95%CI) | 82 ^c | 14 ^d | / | NA NA | / | / | / | / | 153.0 ^e (114.8-204.0) | 309.5 ^{ff} (218.4-438.7) |
| Not measured | | | | | | | | | N=0 | N=4 |
| Neutralizing antibodies NT50 Delta GMC (95%CI) | / | / | / | NA NA | / | / | / | / | 65.6 ^{ff} (49.9-86.1) | 141.0 ^{ff} (90.2-220.5) |
| Not measured | | | N=5 | | | | | | N=0 | N=17 |
| RBD IgG avidity Koff (1/s) GMC (95%CI) | / | / | 0.0011 (0.00063-0.0020) | NA NA | / | / | / | / | 0.00024 (0.00015- 0.00036) | 0.00089 (0.00066-0.00011) |

| TIMEPOINTS | |
|-------------|------------------------------------|
| D1_DAY00 | before vaccine dose 1 |
| D1_DAY49-56 | 49 to 56 days after vaccine dose 1 |
| D2_DAY00 | before vaccine dose 2 |
| D2_DAY07 | 7 days after vaccine dose 2 |
| D2_DAY28 | 28 days after vaccine dose 2 |

| | |
|--|--|
| N | number of samples |
| / | samples not tested yet at the timepoint |
| Not measured | missed sample or sample not valid for testing or sample not tested yet |
| NA | no samples collected at the timepoint |
| * value under detection limit for a) N = 16 b) N = 30 c) N = 16 d) N = 36 e) N = 2 f) N = 14 g) N = 15 | |
| ** titer > 1600 adjusted to 1600 for N = 3 | |

Conclusions/Learning Points: Our study suggests that the use of mRNAVs in pregnancy could be preferred over AVVs as after mRNA vaccination higher RBD antibody titers are reached within a shorter time frame. Also neutralizing capacity and avidity of antibodies is significantly higher after 2 doses of

mRNAV compared to AVV. Using mRNAVs results in a reduced time window of vulnerability in pregnancy and induces antibodies of higher quality that could be transported across the placenta to the unborn child.

EP470 / #1778

Topic: AS13. COVID 19 and MIS-C

SARS-COV-2 NEUTRALIZING ANTIBODIES IN HEALTHCARE WORKERS AFTER 6 MONTHS OF VACCINATION WITH AZD1222 (CHADOX1-NCOV19)

E-Posters

E-POSTER VIEWING

Herberth Maldonado¹, Luis Jerez², Joaquín Barnoya³

¹Unidad de Cirugía Cardiovascular de Guatemala, Control Y Prevención De Infecciones, Guatemala, Guatemala, ²Unidad de Cirugía Cardiovascular de Guatemala, Laboratorio Clínico, Guatemala, Guatemala, ³Unidad de Cirugía Cardiovascular de Guatemala, Departamento De Investigación Y Docencia, Guatemala, Guatemala

Backgrounds: Humoral immunity and protection conferred by vaccines against new coronavirus disease 2019 (COVID-19) wane over time. We aimed to evaluate the durability and levels of neutralizing antibodies (nAbs) against COVID-19 in healthcare workers (HCWs) of the largest cardiovascular center in Guatemala six months after receiving two doses of the ChAdOx1-nCoV19 COVISHIELD vaccine.

Methods:: We invited and consented to HCWs from a Cardiovascular Surgery Unit in Guatemala. Those with confirmed COVID-19 infection, who had received a vaccine booster, or other vaccine types, were excluded. We collected blood samples and measured SARS-CoV-2 receptor-binding domain (RBD) IgG chemiluminescent immunoassay (Snibe diagnostics). This assay has a cut-off value of detection of 4.3 BAU/mL.

Results: Participants' median age was 44 years (SD 10), most were female (75%). The seropositivity was 92%, higher in females ($p=0.01$), with a significant difference in weight and height ($p < 0.05$). The median IgG anti-S-RBD was 37.3 BAU/mL (IQR 17.5-98). No significant differences in nAbs levels were found by gender, age groups, or co-morbidities. No significant correlation between nAbs levels and age, weight, height, or body mass index was found. Figure 1. Log 10 anti S-RBD IgG levels by gender.

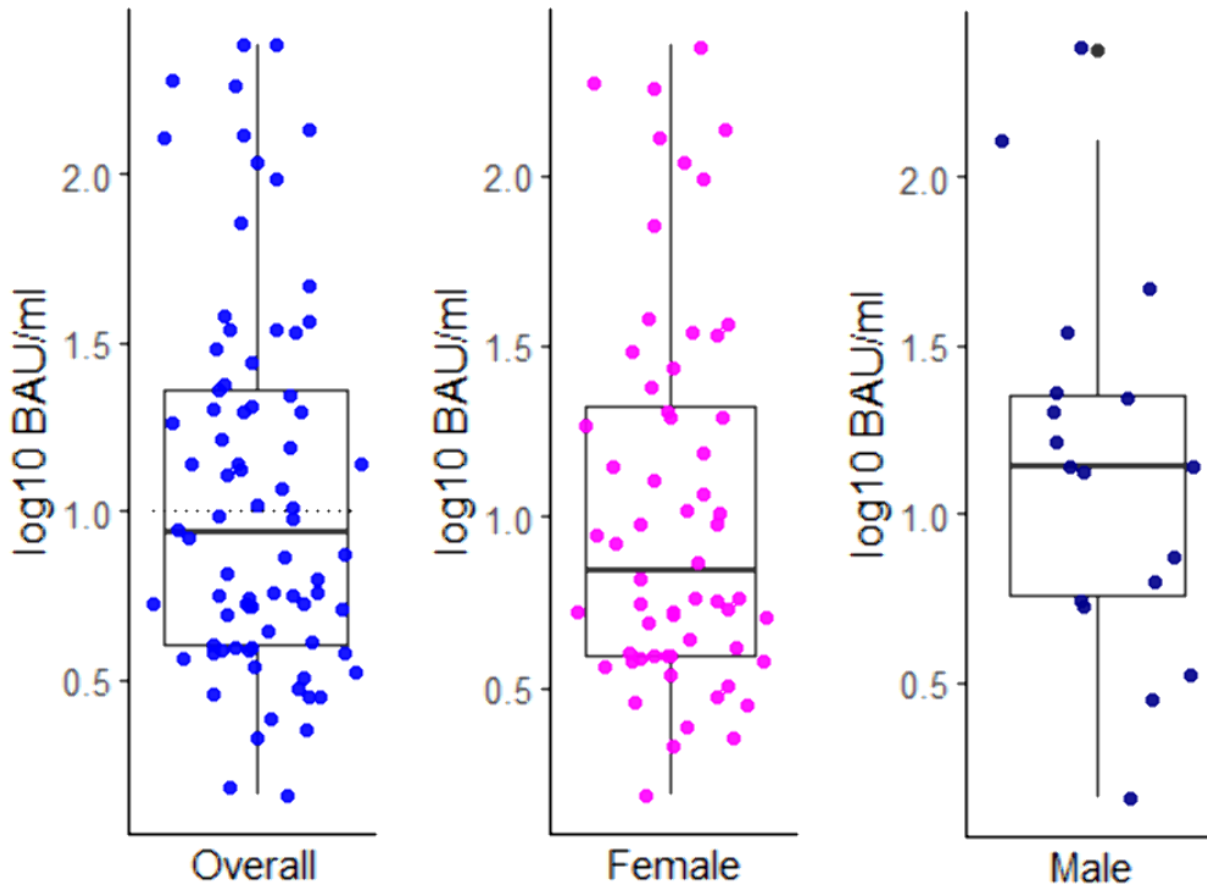

Conclusions/Learning Points: Our results suggest a waning of humoral immunity after two doses of the COVISHIELD vaccine, supporting the need for a booster to strengthen the immune response and restore vaccine effectiveness.

EP471 / #1430

Topic: AS13. COVID 19 and MIS-C

MULTISYSTEM INFLAMMATORY SYNDROME IN CHILDREN (MIS-C) IN A PAIR OF SIBLINGS: CO-INCIDENCE OR GENETIC PREDISPOSITION?

E-Posters

E-POSTER VIEWING

Yamini Mandelia

East Carolina University, Pediatrics- Infectious Disease, Greenville, United States of America

Title of Case: Multisystem inflammatory syndrome in children (MIS-C) in a pair of siblings: co-incidence or genetic predisposition?

Background: Kawasaki disease is an inflammatory disease of unknown etiology typically presenting in young children. On the other hand, MIS-C is an inflammatory syndrome in children, typically seen as a post-infectious complication of COVID-19 infection or exposure. Here I am presenting a pair of siblings who developed MIS-C, one week apart.

Case Presentation Summary: 11 month old boy presented with fevers for 5 days and diffuse erythematous maculo-papular rash, bilateral conjunctival hyperemia, erythematous lips and bilateral distal extremity swelling, in the setting of COVID-19 exposure 4 weeks prior to presentation. His serology for COVID-19 was positive and inflammatory markers were elevated. No cardiac involvement noted on echocardiogram. He was diagnosed with MIS-C and given a dose of Intravenous Immune globulin (IVIG) and Methylprednisolone, to which he had no improvement. He was then initiated on Anakinra (Interleukin-1 receptor antagonist) to which he responded well. His symptoms resolved within 72 hours and his inflammatory markers improved. 1 week prior to this, his 7 year-old stepbrother (same father) presented with fever for 3 days, bilateral non-purulent conjunctival hyperemia, erythematous lips, unilateral cervical lymphadenopathy and erythematous palms and soles. He did not have any cardiac involvement. He was diagnosed with MIS-C and improved with IVIG.

Learning Points/Discussion: So far, this is the second report to describe a pair of siblings with MIS-C who presented within short time interval. This brings up the possibility of genetic predisposition to MIS-C. Genetic variants contributing to impairment of regulation of inflammatory signals have been described in children with MIS-C. Temporal clustering of cases points to MIS-C being a multifactorial disease with genetic predisposition and an infectious trigger.

EP472 / #1155

Topic: AS13. COVID 19 and MIS-C

CARDIAC OUTCOME AFTER SIX MONTHS IN CHILDREN WITH MIS-C

E-Posters

E-POSTER VIEWING

Emma Manno¹, Donato Amodio¹, Carmela Giancotta¹, Nicola Cotugno¹, Veronica Santilli¹, Paola Zangari¹, Gioacchino Rotulo¹, Giulio Calcagni², Marcello Chinali², Alessio Franceschini², Federica Gentili³, Gabriella Bottari⁴, Aurelio Secinaro⁵, Fabrizio Drago², Paolo Palma¹

¹Bambino Gesù Children's Hospital, Clinical Immunology And Vaccinology, Rome, Italy, ²Bambino Gesù Children Hospital, Department Of Pediatric Cardiology And Cardiac Surgery, Rome, Italy, ³Bambino Gesù Children's Hospital, Division Of Sports Medicine, Rome, Italy, ⁴Bambino Gesù Children's Hospital, Pediatric Emergency Department, Pediatric Intensive Care Unit, Rome, Italy, ⁵Bambino Gesù Children's Hospital, Department Of Imaging, Rome, Italy

Title of Case: CARDIAC OUTCOME AFTER SIX MONTHS IN CHILDREN WITH MIS-C

Background: Cardiac involvement is very common in multisystem inflammatory syndrome in children (MIS-C). Myocardial dysfunction, coronary abnormalities and heart rhythm abnormalities are prominent features. In this study we aim to evaluate the early and 6-month follow-up outcomes of MIS-C.

Case Presentation Summary: This is a longitudinal 6-month cohort study of 20 children admitted and treated for MIS-C from October 2020 and August 2021 at Bambino Gesù Children's Hospital in Rome. Patients were followed 4-6 weeks and 4-6 months postadmission. The median age of children was 7 years at admission, 50% were male. Acutely, 9 (45%) patients had left ventricular (LV) systolic dysfunction, 4 (20%) of whom required intensive care with vasoactive support, 5 (25%) had coronary dilatation (z score <2.5) and 1 (5%) presented a first and second degree atrioventricular block. All patient received at admission immunomodulatory treatment consisting of methylprednisolone and/or intravenous immunoglobulin. Among patient admitted in intensive care unit 1 (5%) patient required CytoSorb hemoperfusion and in 2 (10%) patients was administered anti-IL1 inhibitors. The median length of stay was 13 days. At 4-6 weeks postadmission 2 (10%) patient had persistent dilated coronary artery. None had LV systolic dysfunction or heart rhythm abnormalities. At 4-6 months all patients returned to functional baseline with normal LV systolic function and resolution of coronary abnormalities. No persistent heart rhythm abnormalities were observed. Cardiac MRI performed during recovery in patients with systolic dysfunction didn't revealed any myocardial fibrosis.

Learning Points/Discussion: A prompt treatment with immunomodulatory drugs led to a rapid recovery and no cardiac sequelae were observed. However, to date the cardiac long-term outcomes in MIS-C patients are unknown, thus a strict follow-up and larger cohorts studies are deeply needed.

EP473 / #1861

Topic: AS13. COVID 19 and MIS-C

CARDIAC OUTCOMES AFTER IMMUNIZATION WITH MRNA-BASED COVID-19 VACCINES IN ADOLESCENTS

E-Posters

E-POSTER VIEWING

Emma Manno¹, Donato Amodio¹, Veronica Santilli¹, Carmela Giancotta¹, Nicola Cotugno¹, Gioacchino Rotulo¹, Paola Zangari¹, Chiara Rossetti², Attilio Turchetta³, Federica Gentili³, Giulia Cafiero³, Giulio Calcagni⁴, Marcello Chinali⁴, Alessio Franceschini⁴, Aurelio Secinaro⁵, Paolo Palma¹

¹Bambino Gesù Children Hospital, Clinical Immunology And Vaccinology, Rome, Italy, ²University of Rome "Tor Vergata", Academic Department Of Pediatrics (dpuo), Bambino Gesù Children's Hospital, Rome, Italy, Rome, Italy, ³Bambino Gesù Children's Hospital, Division Of Sports Medicine, Rome, Italy, ⁴Bambino Gesù Children Hospital, Department Of Pediatric Cardiology And Cardiac Surgery, Rome, Italy, ⁵Bambino Gesù Children's Hospital, Department Of Imaging, Rome, Italy

Title of Case: CARDIAC OUTCOMES AFTER MRNA COVID-19 VACCINES

Background: Vaccination against COVID-19 has showed an undeniable public health benefit, but it also could result in potential adverse events. Acute myocarditis is a rare complication of the mRNA-based vaccines and although mostly self-limiting, long-term sequelae remain unclear.

Case Presentation Summary: From September 2021 to February 2022 we observed 13 patients, eleven male and 2 female adolescent (median age $15 \pm 1,6$ years) with acute pericarditis/myocarditis with onset 1 to 48 days after mRNA vaccination (11 patients after Comirnaty and 2 after Spikevax). All patients presented with chest pain. Diagnosis was made based on clinical presentation, increased levels of troponin-T (mean peak value, 641 ± 471 pg/mL) and NT-proBNP and pathognomonic electrocardiographic (ECG) and echocardiographic abnormalities. Ten (54%) of them presented with myopericarditis, three (23%) showed myocarditis and three (23%) had pericarditis. Cardiac magnetic resonance (MRI) was performed in 5 patients among those who had myocarditis/myopericarditis and findings were consistent with myocarditis in all patients, including early gadolinium enhancement and late gadolinium enhancement (LGE). Alternative virological causes of myocarditis were excluded. All patients were treated with ibuprofen and were discharged in stable condition with resolved symptoms after few days (mean length of stay, 9 days). Two patient repeated cardiac MRI after three months that showed persistent, although decreased, LGE. At this time point the other cardiologic findings (ECG, echocardiography, cardiac enzyme, Holter ECG and stress testing) were normal.

Learning Points/Discussion: In our case series all patients showed clinical recovery. However, the evidence of persistent cardiac MRI lesion highlights the need for a close and standardized follow-up for all patients who present sign of myocarditis/myopericarditis. Further studies in this population are needed to investigate the personal susceptibility to develop complications after mRNA vaccination.

EP474 / #1450

Topic: AS13. COVID 19 and MIS-C

SARS-COV-2 IGG ANTIBODY RESPONSE AFTER IMMUNIZATION OF HEALTHCARE WORKERS IN A CHILDREN HOSPITALS

E-Posters

E-POSTER VIEWING

Masoud Alebouyeh¹, Roxana Mansour Ghanaiee¹, Armin Shirvani¹, Mahnaz Jamee², Arezu Amirali¹, Abdollah Karimi¹, Fatemeh Fallah¹, Shamsollah Noripour³, Maryam Moemeny⁴, Hannan Khodaie¹, Soheila Sadat Vaghefi⁵, Shahnaz Armin¹, Zari Gholinegad¹, Leila Azimi¹

¹Research Institute for Children's Health, Pediatric Infections Research Center, Mofid Children's Hospital, Shahid Beheshti University of Medical Sciences, Pediatric Infectious Disease, tehran, Iran, ²mofid children hospital, Nephrology, tehran, Iran, ³shahid beheshti university, Neonatal Ward, tehran, Iran, ⁴shahid beheshti university, Nurse, tehran, Iran, ⁵shahid beheshti university, Mofid Children Hospital, tehran, Iran

Backgrounds: Health care personnel (HCP) in children hospitals are potentially high-risk for contracting SARS-CoV-2 infection due to their close contact with the infected patients. Accordingly, effective immunity against the infection is necessary for their protection from severe infection. In this study we aimed to investigate the seroprevalence of and factors associated with SARS-CoV-2 infection among HCP of children hospital.

Methods: The study was done in a hospital in Tehran, Iran between March 2021 and September 2021. Ratio of anti-spike IgG antibodies was measured among HCP before vaccination and after the first and second doses of the Sputnik, vaccine. Blood samples were taken from each HCP before getting vaccinated and four weeks after completing each doses of the vaccine.

Results: Out of a total of 686 HCP (mean age of 40) were enrolled in our study, antibody against S1 domain of SARS-CoV-2 was detected in 48.3%, 95.5%, and 96.2% of HCP before, after the first and the second doses of the vaccines, respectively. Infection with SARS-CoV-2 was significantly lower after the first and second vaccination among HCP who presented higher antibody titers before the vaccination (Odds ratio 0.67 and 0.68, respectively). The onset of SARS-CoV-2 infection after vaccination was recorded after 99-147 days (sputnik, average, 83 days) . The infection didn't show correlation with BMI, age, No. of family members, and familial infection history.

Conclusions/Learning Points: Two doses of SARS-CoV-2 vaccines could induce antibody response in >96% of HCP. History of previous infection with SARS-CoV-2 seems to boost stronger humoral immunity in HCP. Our findings showed increase in the number of infection after 3-5 months of the second vaccination course..

EP476 / #1201

Topic: AS13. COVID 19 and MIS-C

COVID-19 AND MENINGOCOCCUS SEPSIS CO-INFECTION IN AN INFANT

E-Posters

E-POSTER VIEWING

Anna Hermine Markowich¹, Martina Di Giuseppe¹, Sara Chiurchiù¹, Nicole Olivini², Laura Corsi¹, Francesca Ippolita Calò Carducci¹, Paola Bernaschi³, Laura Lancella¹

¹Bambino Gesù Children's Hospital, IRCCS, Immunology And Infectious Diseases Unit, Rome, Italy, ²Bambino Gesù' Children's Hospital, Department Of Pediatrics, Rome, Italy, ³Bambino Gesù Children's Hospital, Unit Of Microbiology, Rome, Italy

Title of Case: COVID-19 AND MENINGOCOCCUS SEPSIS CO-INFECTION IN AN INFANT

Background: SARS-CoV-2 infection in infants presents with non-specific symptoms, including fever and difficulty feeding, and compared to bacterial infections, inflammatory markers are usually lower. Bacterial co-infections are common in many respiratory viral infections and have also been described in COVID-19. We report a febrile infant with SARS-CoV-2 infection and meningococcal sepsis.

Case Presentation Summary: A 6-month-old infant presented to the emergency department with fever and difficulty feeding for the previous 24 hours. He appeared unwell and had a papular rash, while the rest of the examination was unremarkable. Blood tests showed elevated C-reactive protein (CRP 80 mg/l). Nasopharyngeal swab was positive for Sars-CoV-2. The child was admitted to the infectious diseases ward. Within the following few hours his general state rapidly worsened, he was pale, hypotensive and developed a purpuric rash at the lower extremities. His neurological state had deteriorated, the lumbar puncture resulted negative for meningitis. Blood test showed a further increase in CRP (160 mg/l) associated with increase in procalcitonin and alterations of hemostasis parameters. *Neisseria meningitidis* septic shock was suspected, which was confirmed by molecular screening on blood. Treatment with ceftriaxone was started and the patient was transferred to intensive care unit where he was stabilized. In 48 hours he improved clinically, treatment was continued for 14 days and the patient was then discharged in good health.

Learning Points/Discussion: In conclusion, in a fever without origin in an infant COVID-19 should be ruled out. In SARS-CoV-2 infection in infants, especially in the presence of elevated inflammatory markers, a bacterial co-infection should be investigated. *N. meningitidis* sepsis is a medical emergency where prompt treatment is of the utmost importance in determining the patient's outcome.

EP477 / #1446

Topic: AS13. COVID 19 and MIS-C

A CHILD WITH NEW ONSET NEPHROTIC SYNDROME AS THE MAIN MANIFESTATION OF SARS-COV-2 INFECTION

E-Posters

E-POSTER VIEWING

Artemis Mavridi, Garyfallia Syridou, Efstathios Stefos, Kyveli Chiotopoulou, Vassiliki Papaevangelou
National and Kapodistrian University of Athens, Third Department Of Pediatrics, Attikon University
Hospital, Athens, Greece

Title of Case: A child with new-onset nephrotic syndrome as the main manifestation of SARS-CoV-2 infection

Background: COVID-19 is primarily a respiratory infection and mostly has a mild presentation in children. SARS-CoV-2-associated nephrotic syndrome has rarely been described in paediatric population, mainly as a relapse of a preexisting condition.

Case Presentation Summary: A 7-year-old girl was admitted to our hospital due to periorbital and lower extremity edema with a 3-day history of fever and intermittent abdominal pain. On admission, she was feverless, normovolemic and with SatO₂ 97%. RT-PCR was positive for SARS-CoV-2. Her blood and urine tests showed mild leucopenia, hypoproteinemia, hypercholesterolemia and proteinuria. Ferritin, CRP and IL-6 were within normal limits, while fibrinogen and D-dimers were increased. Her blood gas and chest Xray were unremarkable and her abdominal US showed a small accumulation of ascitic fluid. Investigation for autoimmunity or post-streptococcal glomerulonephritis was unremarkable. Patient was seronegative for hepatitis viruses and HIV. The girl was treated with prednisone and due to significant hypoalbuminemia with human albumin and furosemide. Due to the risk of thromboembolic events, she received, prophylactic, low dose heparin SC for 12 days. Her clinical picture and lab tests gradually improved and she was discharged with oral prednisone for at least 3 months. Upon follow-up she is in excellent condition, normovolemic and without proteinuria. The most probable diagnosis, based on her age, response to corticosteroids and normal renal function and absence of hypertension is minimal change disease.

Learning Points/Discussion: This is the first paediatric case with new onset nephrotic syndrome as the main manifestation of COVID-19 infection in a febrile child with no respiratory or gastrointestinal symptoms. Although references are rare so far, paediatricians should be aware of SARS-CoV-2 as a cause of nephrotic syndrome either new-onset or relapse

EP478 / #896

Topic: AS13. COVID 19 and MIS-C

A RARE CASE OF ENCEPHALITIS IN AN ADOLESCENT BOY FOLLOWING THE FIRST DOSE OF BNT162B2 MRNA COVID-19 VACCINE

E-Posters

E-POSTER VIEWING

Despoina Tatarioti¹, Konstantina Patouni¹, Maria Xatzipsalti¹, Vassiliki Ziaka², Stella Mouskou², Dimitrios Delis¹, [Mersyni Mavrikou](#)¹

¹"P&A Kyriakou" Children's Hospital, First Paediatric Department, Athens, Greece, ²"P& A Kyriakou" Children's Hospital, Department Of Neurology, Athens, Greece

Title of Case: A rare case of encephalitis in an adolescent boy following the first dose of BNT162b2 mRNA COVID-19 vaccine

Background: Over the past year different types of COVID-19 vaccines have been used worldwide with good efficacy and safety. However, a variety of side-effects including rare neurological complications have been reported.

Case Presentation Summary: A previously healthy 13-year-old male was admitted due to an episode of generalized seizures followed by altered level of consciousness. Nine days ago, he received the first dose of BNT162b2 mRNA COVID-19 vaccine. Upon admission, he appeared disorientated and confused, with inappropriate speech and dilated pupils and developed fever up to 39.5°C. No focal neurological deficits were present. Brain CT and MRI scans were normal. Inflammatory markers were negative. CSF analysis revealed pleocytosis (25 cells/ μ l) with normal glucose and protein levels. Treatment with acyclovir, ceftriaxone and levetiracetam was initiated. Within one day after admission, his state of consciousness returned to normal. Extensive work-up excluded auto-immune and infectious encephalitis. Antiviral and antibiotic treatment was discontinued. EEG showed slow brain electrical activity. Abs IgG against Sars-CoV2 S1protein and S protein RBD in serum and CSF were positive, whereas Abs IgG/IgM against Sars-CoV2 Nucleocapsid (N) were negative, suggesting a possible link to vaccination. The serum antibody titres against S protein RBD were unusually high (76,029AU/ml). After discharge, the patient remains asymptomatic and under neurological follow-up.

Learning Points/Discussion: Temporal correlation, absence of autoimmune or infectious causes and positive Abs against Sars-CoV2 S1 without Abs against nucleocapsid suggest a possible relationship of this case to the vaccine. Although further studies are required to clarify the pathogenesis of COVID-19 vaccination-related adverse events, the benefit of Covid-19 vaccination outweighs the risk of such rare side effects.

EP479 / #730

Topic: AS13. COVID 19 and MIS-C

PSYCHO-EMOTIONAL WELL-BEING OF CHILDREN AND ADOLESCENTS DURING ACUTE COVID-19 INFECTION IN LATVIA

E-Posters

E-POSTER VIEWING

Anija Meiere^{1,2}, Liga Butnare¹, Liene Smane², Anda Kivite-Urtane², Ieva Roge¹, Iveta Racko¹, Zanda Pucuka¹, Lizete Klavina¹, Jana Pavare²

¹Children's Clinical University Hospital, Department Of Paediatrics, Riga, Latvia, ²Riga Stradins University, Riga Stradins University, Riga, Latvia

Backgrounds: Recent studies suggest that not only acute COVID-19 infection, but also COVID-19-related restrictive measures have a great impact on children and adolescent mental health. The purpose of this study was to describe the influence of COVID-19 on psycho-emotional well-being of the children.

Methods: The study design is a retrospective longitudinal study. From March 2020 to December 2020 fifty-two paediatric COVID-19 patients (age 6-18 years) and their parents were enrolled in the study. Data were collected through a validated questionnaire (Achenbach Child Behaviour Checklist) in a face-to-face visit. Questions were on the scales of anxiety, depression, relationship difficulty and aggressive behaviour. The evaluation was performed in 3 time periods - before, during and after acute COVID-19. Descriptive statistics were used to present the data. Selected alpha value was 0.05.

Results: All together fifty-two (n=52) children were enrolled in the study. Statistically significant results were obtained by comparing the results on the anxiety scale, median score before COVID-19 - 3,5 points, during COVID-19 – 5,0 points and after COVID-19 – 4,0 points. Statistically significant results were also on the depression scale, median score before COVID-19 - 1,5 points, during COVID-19 – 3,0 points and after COVID-19 – 2,0 points and on relationship difficulty scale, median score in all 3 time periods – 2,0 points. 27% (n=14) of children still have complaints about cognitive difficulties in the period after recovery from COVID-19.

Conclusions/Learning Points: The results of the study suggest that among children and adolescents aged 6-18 years their symptoms of anxiety, depression and relationship difficulties are increasing during the acute phase of COVID-19. It is important to monitor the impact of COVID-19 on children's and adolescents' psycho-emotional well-being.

EP480 / #1077

Topic: AS13. COVID 19 and MIS-C

VACCINE HESITANCY AMONG PORTUGUESE PARENTS: IS THERE A DIFFERENCE BETWEEN NATIONAL VACCINATION PROGRAMME VACCINES, VACCINES NOT INCLUDED IN NATIONAL VACCINATION PROGRAMME, AND A COVID-19 VACCINE?

E-Posters

E-POSTER VIEWING

Sofia Miranda¹, Cátia Silva¹, André Costa Silva¹, André Costa Azevedo¹, Laura Marques², Hugo Rodrigues¹

¹Unidade Local de Saúde do Alto Minho, Pediatrics, Viana do Castelo, Portugal, ²Centro Materno Infantil do Norte, Pediatric Infectious Diseases And Immunodeficiencies Unit, Department Of Pediatrics, Porto, Portugal

Backgrounds: Vaccine hesitancy is becoming increasingly relevant due to resurging of vaccine-preventable diseases, threatening vaccination historic success. Since COVID-19 pandemic began, the development of an effective vaccine has been pointed out as the possible alternative to its end.

Methods: A cross-sectional observational study survey was made available online between 22 March and 23 April 2020, during the first national lockdown due to COVID-19, addressing parents with children under the age of 18 years. The survey was developed based primarily on questions of Vaccine Hesitancy Scale (VHS). Exploratory factor analysis evaluated VHS subscales. Four questions from VHS were also applied to two vaccines included in the National Vaccination Programme (PNV), a vaccine not included in PNV vaccines, and a possible COVID-19 vaccine.

Results: We had 2752 responses. Overall, 87% of respondents self-reported themselves as not hesitant. Over 90% of parents demonstrated confident attitudes. Although several issues related to the adverse effects of vaccines and the safety of new vaccines are a cause for concern for most parents. We identified two constructs underlying VHS, such as “confidence” and “risks/complacency”, and significant associations between them and some respondent characteristics, like age of the mother and respective educational level. COVID-19 vaccine demonstrated a statistically significant lower median response compared to other vaccines for questions regarding the importance for my child’s health, trustworthiness of information and not being concerned about adverse effects.

Conclusions/Learning Points: Vaccine hesitancy does not appear to be a major problem in Portugal, but careful and continuous monitoring must be done. During the COVID-19 pandemic situation, the reported vaccine hesitancy related to COVID-19 vaccine constitutes a possible threat to the current solution to the pandemic. Public health strategies must address vaccine hesitancy, consolidating confidence in vaccines.

EP481 / #1100

Topic: AS13. COVID 19 and MIS-C

HIGH LETHALITY OF PEDIATRIC MULTISYSTEMIC INFLAMMATORY SYNDROME RELATED TO SARS-COV-2 IN SÃO PAULO, BRAZIL – A MULTICENTRIC EXPERIENCE

E-Posters

E-POSTER VIEWING

Flávia Almeida¹, Daniel Jarovsky^{1,2}, Camila Almeida Farias², Andressa Aguiar², Maria Pereira², Heloisa Marques², Luciana Helman², Antonio Siqueira², Gustavo Scremin², Marcelo Otsuka³, Paula Alvares², Carolina Araújo², Roberta Laporte², Fabianne Carlesse², Andressa Tannure¹, Mariana Arnoni¹, Camila Morais⁴, Fernanda Ejzenberg², Cibele Borsetto², Giovanna Guerra¹, Marcus Martuchelli⁴, Samantha Matos¹, Eitan Berezin⁵, Marco Aurélio Palazzi Sáfadi²

¹Santa Casa de São Paulo, Pediatric Infectious Diseases, São Paulo, Brazil, ²Sabará Children's Hospital, Pediatric Infectious Diseases, São Paulo, Brazil, ³Darcy Vargas's Children Hospital, Infectious Diseases, São Paulo, Brazil, ⁴Santa Casa de São Paulo, Pediatric Infectious Disease, São Paulo, Brazil, ⁵Santa Casa, Pediatric, SAo Paulo, Brazil

Backgrounds: Multisystemic inflammatory syndrome associated to SARS-CoV-2 (PIMS-TS/MIS-C) was described at the beginning of the COVID-19 pandemic and stands for a challenge for pediatricians and health systems. Brazilian numbers suggest higher mortality than high-income countries, but clinical data are still scarce.

Methods: In this multicentric study we evaluated all children and adolescents diagnosed with PIMS-TS from April 2020 to March 2021 in 16 hospitals in the metropolitan region of São Paulo. Clinical and demographic information was systematically extracted from electronic medical records for each case.

Results: 101 children met the WHO criteria for PIMS-TS. The median age was 67 months, 60% were male, 28.7% were black and 83% had no underlying comorbidities. Seventy percent had dermatological, gastrointestinal, or cardiac involvement. Intensive care was needed in 73% of the children and 20% required mechanical ventilation. Shock was described in 35% and case fatality rate was 4% (n=4). SARS-CoV-2 was detected in 25% of cases and a positive serologic test in 67%. Half of the patients had the Kawasaki-like phenotype. An abnormal echocardiography was found in 61% of cases, with pericardiac effusion as the leading finding in almost 40% of these cases. Most children were treated with high-dose immunoglobulin (93%) or corticosteroids (62%). Respiratory distress and abdominal pain were associated with nonspecific phenotype (OR: 0.2; 95% C.I. 0.03-0.86) and patients with significant comorbidities had longer hospitalization (p=0.014; 95% C.I. 1.02-1.23).

Conclusions/Learning Points: SIM-P is a severe clinical form with prominent cardiac involvement. When compared to the international literature, our cohort had lower median age and higher case fatality rate.

EP482 / #1013

Topic: AS13. COVID 19 and MIS-C

EVIDENCE OF IMMUNE EXHAUSTION ON CD4 AND CD8 T CELLS IN CHILDREN WITH KAWASAKI DISEASE AND COVID-19 INFECTION BUT NOT IN COVID-19 NEGATIVE CHILDREN

E-Posters

E-POSTER VIEWING

Katarine Rufca¹, Ana Flavia Pina², Rogério Do Prado², Luan Cesar Coelho³, Cristina De Magalhães⁴, Caroline De Paiva⁴, Rozana De Almeida⁵, Melissa Fraga⁶, Maria Teresa Terreri², Gleice Clemente², Maria Isabel Moraes-Pinto¹

¹Universidade Federal de São Paulo - UNIFESP, Division Of Pediatric Infectious Diseases - Department Of Pediatrics, São Paulo, Brazil, ²Universidade Federal de São Paulo - UNIFESP, Division Of Pediatric Rheumatology – Department Of Pediatrics, São Paulo, Brazil, ³Hospital da Luz, Pediatric Rheumatology, São Paulo, Brazil, ⁴Hospital da Criança de Brasília José Alencar, Division Of Pediatric Rheumatology – Department Of Pediatrics, Distrito Federal, Brazil, ⁵Instituto Martagão Gesteira, Division Of Pediatric Rheumatology – Department Of Pediatrics, Rio de Janeiro, Brazil, ⁶Universidade Federal de São Paulo - UNIFESP and Hospital Darcy Vargas, Division Of Pediatric Rheumatology – Department Of Pediatrics, São Paulo, Brazil

Backgrounds: Kawasaki disease (KD) is an acute inflammatory febrile syndrome, the leading cause of acquired heart disease in the Western world and the second leading cause of vasculitis in childhood that predominantly affects children between six months and five years of age. During the COVID-19 pandemic, an increase in KD cases has been observed, some of them associated with SARS-CoV-2 infection. The objective of this work is to compare the immunological aspects of patients with KD both with and without SARS-CoV-2 infection.

Methods: This is a prospective, multicenter observational study in partnership with 5 Brazilian Pediatric Rheumatology services carried out between July 2020 and July 2021. Thirteen children and adolescents without previous COVID-19 vaccination and who were diagnosed with complete or incomplete KD were evaluated for the presence or absence of SARS-CoV-2 infection detected by RT-PCR test or serology test. An 8 mL-blood sample was drawn into EDTA test tube prior to intravenous immunoglobulin (IVIG) treatment. A second blood sample was taken 14 to 21 days thereafter. A complete blood count was assessed and immunophenotyping of T and B cells was evaluated by flow cytometry.

Results: The demographic characteristics of patients and clinical and immunological data are described in Table

1.

Table 1. Characteristics of patients with Kawasaki disease with and without COVID-19 positive results.

| PARAMETER | COVID-19 + (n=5) | COVID 19 - (n=8) | p value |
|--|-----------------------------|-------------------------------|--------------|
| Median age in years (range) | 6 (3-10) | 1 (0.2-6) | 0.048 |
| Male gender patients (%) | 4 (80) | 5 (62.5) | 0.609 |
| Patients with complete Kawasaki disease (%) | 3 (60) | 4 (50) | >0.999 |
| Median total lymphocytes/mm ³ pre IVIG (range) | 890.0 (348-1965) | 3347.0 (1375-5584) | 0.008 |
| Median total neutrophils pre IVIG (range) | 6072.0 (2453-10017) | 10459.5 (4108-21306) | 0.107 |
| Median platelets /mm ³ pre IVIG (range) | 165,000 (46,000-890,000) | 497,500 (23,600-1,114,000) | 0.057 |
| Median % PD-1 on CD4 T cells pre IVIG (range) | 9.2 (4.0-25.9) | 10.2 (2.8-62.6) | 0.661 |
| Median % PD-1 on CD4 T cells post IVIG (range) | 12.4 (5.0-95.0) | 4.8 (1.8-7.3) | 0.019 |
| Median % PD-1 on CD8 T cells pre IVIG (range) | 17.1 (6.5-20.5) | 11.0 (3.9-43.2) | 0.770 |
| Median % PD-1 on CD8 T cells post IVIG (range) | 19.8 (7.6-49.4) | 6.7 (1.1-15.8) | 0.019 |
| Median % CD19 cells pre IVIG (range) | 15.4 (2.78-28.7) | 22.6 (13.0-38.0) | 0.380 |
| Median % CD19 cells post IVIG (range) | 15.6 (2.30-24.0) | 15.7 (10.5-65.2) | 0.884 |
| Median % plasmablasts pre IVIG (range) | 1.7 (0.5-5.6) | 1.0 (0.4-4.2) | 0.341 |
| Median % plasmablasts post IVIG (range) | 3.1 (1.2-10.3) | 0.3 (0.1-5.6) | 0.019 |

Conclusions/Learning Points: COVID-19 positive children who develop KD show higher plasmablast percentage and higher PD-1 expression on CD4 and on CD8 T cells post IVIG than those without evidence of COVID-19 disease, suggesting intense inflammatory response and immune exhaustion after SARS-CoV-2 infection.

EP483 / #1294

Topic: AS13. COVID 19 and MIS-C

AN ATYPICAL PRESENTATION OF MULTISYSTEM INFLAMMATORY SYNDROME AFTER COVID-19 (MIS-C) IN AN INFANT

E-Posters

E-POSTER VIEWING

Minca Mramor¹, Tina Duh¹, Nuša Cesar², Katarina Vincek¹, Tina Plankar Srovin¹, Tanja Avramoska¹, Urška Šivic¹, Natalija Bahovec¹, Aida Granda¹, Maja Arnež¹, Tadej Avčin², Mojca Rožič¹
¹University Medical Center Ljubljana, Department Of Infectious Diseases, Ljubljana, Slovenia, ²University Medical Center, Paediatric Clinic, Ljubljana, Slovenia

Title of Case: MIS-C in an infant

Background: A previously healthy 10-week-old boy presented with a 4 day history of projectile vomiting followed by bloody diarrhea and poor feeding. On admission, he was afebrile, the physical exam was unremarkable. He had leukocytosis, thrombocytosis and mildly elevated CRP (12 mg/dl). Abdominal ultrasound was normal and extensive microbiological testing was negative. A diet with an extensively hydrolysed formula was introduced and additional parenteral fluids were required to cover his losses. Regardless, the diarrhea continued and by day 6 of hospitalization he had lost 200 grams.

Case Presentation Summary: On day 7 diarrhea and irritability worsened and a purpuric rash appeared on his feet. Signs of protein-losing enteropathy with hypoalbuminemia, coagulopathy and periorbital edema developed. Pro-BNP and D-dimer were elevated, CRP increased slightly (33 mg/dl). Repeated abdominal ultrasound showed gallbladder hydrops. Additional history revealed that his parents had COVID-19 six weeks prior to this illness. SARS-CoV-2 serology was positive in the infant. A diagnosis of postcovid vasculopathy/MIS-C was then proposed. Treatment with immunomodulatory therapy was started with intravenous immunoglobulins, glucocorticoids and low dose acetylsalicylic acid. Supportive treatment of hypoalbuminemia, hyponatremia and hypokalemia was required. The clinical state began to improve after the initiation of immunosuppressive therapy. No new purpuric changes appeared, his feeding improved and his stools normalized.

Learning Points/Discussion: While MIS-C has been described in infants, it typically affects older children that present with fever and multiorgan involvement. This patient presented with isolated gastrointestinal symptoms and no fever throughout the duration of his illness and therefore posed a diagnostic challenge. Several differential diagnoses, including pyloric stenosis, infectious gastroenteritis, and allergic proctocolitis, were considered. The development of purpuric skin lesions and laboratory signs of multisystemic involvement led us to the diagnosis of MIS-C.

EP484 / #360

Topic: AS13. COVID 19 and MIS-C

PAPILLEDEMA IN PATIENTS WITH MULTISYSTEM INFLAMMATORY SYNDROME: IS AN OPHTHALMOLOGICAL EXAM USEFUL?

E-Posters

E-POSTER VIEWING

Alberto Muñoz¹, Ana Ortueta², Cristina Lopez³, Sara Domínguez⁴, Elisa Fernandez¹, Cinta Moraleda¹, Daniel Blázquez-Gamero¹, Luis Prieto¹, Jaime Carrasco⁵, Angela Manzanares¹, David Torres¹, Serena Villaverde¹, Pablo Rojo¹, Cristina Epalza¹

¹HOSPITAL 12 DE OCTUBRE, Paediatrics, MADRID, Spain, ²HOSPITAL 12 DE OCTUBRE, Paediatric Ophthalmology, MADRID, Spain, ³HOSPITAL 12 DE OCTUBRE, Pediatric Ophthalmology, MADRID, Spain, ⁴HOSPITAL 12 DE OCTUBRE, Clinical Trials Unit, MADRID, Spain, ⁵HOSPITAL SON ESPASES, Paediatrics, PALMA DE MALLORCA, Spain

Backgrounds: Children with Multisystem Inflammatory Syndrome (MIS-C) associated with SARS-CoV-2 are frequently admitted to the pediatric intensive care unit (PICU) and require vasoactive drugs. However, the outcome of the disease is generally positive. The presence of papilledema has been described in these patients, but its implications are unknown. We aimed to compare MIS-C patients presenting papilledema with those without it and its possible relationship with MIS-C characteristics.

Methods: Patients with MIS-C hospitalized in a tertiary University Hospital in Spain, between January 2021 and October 2021 with an ophthalmological exam performed during the acute phase were included prospectively. Demography, characteristics related to MIS-C evolution, treatment, biological data, neurological and cardiological features were analyzed. Patients with and without papilledema were compared and statistical analysis were performed for selecting factors related to papilledema.

Results: All the sixteen patients hospitalized with MIS-C diagnosis during the study period had an ophthalmological exam performed: four (25%) had papilledema. Patients with papilledema presented a trend to a longer PICU stay (OR 2.25, 95%CI 0.97-5.20, p=0.057) and oxygen support (OR 11.2, 95%CI 0.86-426, p=0.063). The only two patients requiring intubation and presenting neurologic symptoms requiring Neuropediatric evaluation, presented papilledema (p=0,05). There were no differences in the other evaluated factors (Table 1). Neurologic sequelae were not observed and papilledema resolved in a median of 3.5 weeks (IQR 2.5-6) after admission.

TABLE 1. COMPARISON OF PATIENTS WITH MIS-C ACCORDING TO THE PRESENCE OF PAPILLEDEMA.

| | All (N=16) | Papilledema (N=4) | No papilledema (N= 12) | p-value | OR (95%CI) |
|---|-------------------------|-------------------------|---------------------------|--------------|-------------------------|
| Demography | | | | | |
| Age (years) median [IQR] | 9.50 [5.00-12.8] | 13.0 [9.50-16.5] | 7.50 [4.50-11.2] | 0.114 | 1.27 [0.94-1.71] |
| Male n(%) | 9 (56.2%) | 4 (100%) | 5 (41.7%) | | |
| Clinical characteristics | | | | | |
| Time between admission and fundus (days) median [IQR] | 3.50 [2.75-4.50] | 5.00 [1.75-10.5] | 3.50 [3.00-4.00] | 1.000 | 1.15 [0.90-1.47] |
| PICU admission n(%) | 9 (56.2%) | 3 (75.0%) | 6 (50.0%) | 0.585 | 2.64 [0.23-91.2] |
| Length stay in PICU (days) median [IQR] | 1.25 [0.00-2.25] | 5.50 [3.00-7.00] | 0.50 [0.00-1.62] | 0.057 | 2.27 [0.97-5.30] |
| Neurological symptoms n(%) | 2 (12.5%) | 2 (50.0%) | 0 (0.00%) | 0.05 | - |
| Inotropes n(%) | 9 (56.2%) | 3 (75.0%) | 6 (50.0%) | 0.585 | 2.64 [0.23-91.2] |
| Duration of inotropes (hours) median [IQR] | 16.0 [0.00;24.0] | 24.0 [18.0-48.0] | 4.00 [0.00-24.0] | 0.185 | 1.05 [0.96-1.14] |
| Oxygen support n(%) | 5 (31.2%) | 3 (75.0%) | 2 (16.7%) | 0.063 | 11.2 [0.86-426] |
| Mechanical ventilation n(%) | 2 (12.5%) | 2 (50.0%) | 0 (0.00%) | 0.05 | - |
| Cardiological complications n(%) | 14 (87.5%) | 4 (100%) | 10 (83.3%) | 1.000 | - |
| Coronary abnormalities n(%) | 5 (31.2%) | 1 (25.0%) | 4 (33.3%) | - | 0.72 [0.02-8.90] |
| Minimum LVF (%) median [IQR] | 54.0 [49.5-58.5] | 49.0 [44.0-53.8] | 55.0 [50.0-60.5] | 0.162 | 0.84 [0.68-1.05] |
| LVEF<45% n(%) | 3 (18.8%) | 2 (50.0%) | 1 (8.33%) | 0.136 | 8.51 [0.49-348] |
| Laboratory biomarkers | | | | | |
| Hemoglobin (g/dL) median [IQR] | | | | | |
| At admission | 11.5 [10.7-12.7] | 12.6 [11.9-12.8] | 11.3 [10.7-12.5] | 0.504 | 1.26 [0.57-2.81] |
| Minimum | 10.5 [9.50-11.1] | 9.35 [8.90-9.97] | 10.6 [10.3-11.1] | 0.162 | 0.33 [0.08-1.34] |
| Platelets (/mm³) median [IQR] | | | | | |
| At admission | 145500 [115750-195000] | 103000 [87250-141750] | 165000 [123500-195000] | 0.182 | 1.00 [1.00-1.00] |
| Minimum | 145500 [104500-194750] | 86500 [52000-140500] | 165000 [111500-194750] | 0.275 | 1.00 [1.00-1.00] |
| Lymphocytes (/mm³) median [IQR] | | | | | |
| At admission | 600 [400-1060] | 450 [375;525] | 840 [550-1255] | 0.113 | 1.00 [0.99-1.00] |
| Minimum | 600 [375-1060] | 400 [300;525] | 790 [475-1255] | 0.127 | 1.00 [0.99-1.00] |
| CRP (mg/L) median [IQR] | | | | | |
| At admission | 192.0 [153.0-270.0] | 237.0 [191.0-325.0] | 179.0 [152.0-247.0] | 0.396 | 1.10 [0.96-1.26] |
| Maximum | 219.0 [153.0-278.0] | 237.0 [191.0-325.0] | 207.0 [152.0-263.0] | 0.467 | 1.07 [0.95-1.21] |
| Treatment | | | | | |
| 1 st dose IVIG + Corticosteroids n(%) | 16 (100%) | 4 (100%) | 16 (100%) | - | - |
| 2 nd dose IVIG n(%) | 1 (6.25%) | 1 (25.0%) | 0 (0.00%) | 0.250 | - |
| Biologic agents n(%) | 2 (12.5%) | 1 (25.0%) | 1 (8.33%) | 0.450 | 3.32 [0.07-154] |

ABBREVIATIONS. 95%CI: 95% Confidence Interval; IQR: Interquartile Range; PICU: Pediatric Intensive Care Unit; CRP: C-Reactive Protein; LVEF: Left Ventricular Ejection Fraction; IVIG: Intravenous Immunoglobulin.

Conclusions/Learning Points: In our study, papilledema trended to be associated with more severe MIS-C, longer PICU stay, oxygen requirement, need for intubation and neurological symptoms. Papilledema is probably related to central nervous system inflammation. Evaluation of papilledema is an easily available bedside assessment technique that could be included in the evaluation of patients with suspected MIS-C. Its presence could be a predictor of severity.

EP485 / #1448

Topic: AS13. COVID 19 and MIS-C

MULTI-INFLAMMATORY SYNDROME IN CHILDREN IN SINGAPORE

E-Posters

E-POSTER VIEWING

Karen Nadua¹, Kaiqian Kam¹, Jiahui Li¹, Natalie Woon Hui Tan², Chee Fu Yung¹, Lena Das³, Thaschawee Arkachaisri³, Joyce Lam¹, Jonathan Choo⁴, Kai Liang Teh³, Yee Hui Mok⁵, Chia Yin Chong¹, Koh Cheng Thoon¹

¹KK Women's and Children's Hospital, Pediatric Infectious Disease Service, SINGAPORE, Singapore, ²KK Women's and Children's Hospital, Pediatric Medicine, Infectious Diseases Service, Singapore, Singapore, ³KK Women's and Children's Hospital, Pediatric Rheumatology, SINGAPORE, Singapore, ⁴KK Women's and Children's Hospital, Pediatric Cardiology, SINGAPORE, Singapore, ⁵KK Women's and Children's Hospital, Pediatric Intensive Care, SINGAPORE, Singapore

Title of Case: Multi-system Inflammatory Syndrome in Children in Singapore

Background: Despite the high rates of COVID-19 in East Asia, cases of multisystem inflammatory syndrome in children are rarely reported from this region. In Singapore, there were no prior reports of MIS-C since the start of the pandemic until recently in October 2021. We present a case series of 8 children with MIS-C, diagnosed according to the WHO criteria, in KK Women's and Children's Hospital, a tertiary hospital and the national centre for management of children with COVID-19 children in Singapore. We describe their clinical presentation, treatment and outcomes, and discuss the guidelines of our institution for the management of MIS-C.

Case Presentation Summary: Eight cases of MIS-C were identified, with an average age of 6 years. Majority had (6 cases) had gastrointestinal symptoms. Five cases developed shock requiring fluid bolus and/or inotropes; all required intensive care. Muco-cutaneous features and coagulopathy were present in all cases. Lymphopenia and thrombocytopenia were each found in 5 cases. All cases were diagnosed within 2 days of hospitalization and received IVIG and intravenous methylprednisolone. One patient with severe inflammation and shock received subcutaneous IL-1 inhibitor. Anticoagulation with enoxaparin was given to 5 patients for high D-dimer levels. All patients survived. Two patients had coronary artery dilatation detected during outpatient follow-up.

Learning Points/Discussion: The rise of MIS-C cases is likely due to the overall increased incidence of COVID-19 in Singapore. Our MIS-C cases had significant gastrointestinal symptoms and cardiac dysfunction. While Kawasaki disease (KD) is an important differential due to similar muco-cutaneous features and increased incidence in Asian children, the above findings along with lymphopenia and thrombocytopenia, are unusual in KD. Timely diagnosis and treatment with immunomodulators, and multi-disciplinary management resulted to favourable outcomes in our patients.

EP486 / #729

Topic: AS13. COVID 19 and MIS-C

POST-COVID ACUTE LIVER INJURY WITH PSEUDOMONAS MENDOCINA BACTERAEMIA IN A 6 YEAR OLD

E-Posters

E-POSTER VIEWING

Zahabiya Nalwalla, Reepa Agrawal, Akanksha Jaiswal, Ira Shah

Bai Jerbai Wadia Hospital for Children, Department Of Pediatric Infectious Diseases, Mumbai, India

Title of Case: POST-COVID ACUTE LIVER INJURY WITH PSEUDOMONAS MENDOCINA BACTERAEMIA IN A 6 YEAR OLD

Background: The hepatic manifestations of the novel corona virus 2019 (Sars-CoV-2) in children have been isolated to few case reports and case series. They vary from commonly observed transient elevation of liver enzymes to fulminant hepatic failure. We present a 6 year old with post-covid fulminant hepatic failure with hospital acquired Pseudomonas mendocina bacteraemia.

Case Presentation Summary: A 6 year old boy was referred with complaints of fever, abdominal pain for 1 month, a transient macular-papular rash, and jaundice for 3 days. He developed hepatic encephalopathy. Differentials of autoimmune hepatitis, hemophagocytic lymphohistiocytosis secondary to a viral exanthem and MIS-C were considered. His covid antibodies were positive and inflammatory markers elevated. There was no involvement of other organs. He was given steroids, intravenous immunoglobulin and hepato-protective measures (ursodeoxycholic acid, rifaximin, lactulose, vitamin ADEK). His course was complicated by secondary hospital acquired Pseudomonas mendocina bacteremia which responded to meropenem.

| | 29/10/2021 | 5/11/2021 | Onset of encephalopathy, 16/11/2021 |
|--|------------|----------------|--|
| Hemoglobin (g/dl) | 9.2 | | |
| Total Leukocyte Count (cells/cmm) | 14,900 | | |
| Differential Leukocyte Count (N/L/M/E) | 83/3/2/0 | | |
| Platelet Count (L/cmm) | 6.43 L/cmm | | |
| SGOT/SGPT (IU) | 3464/1661 | 1934/1328 | 697/488 |
| TB/DB (mg/dl) | | 6.4/5.9 | 15.1/13.4 |
| Total Protein/Albumin (g/dl) | | 6.1/3.2 | |
| PT/INR | | 22.8/2.07 | |
| Ammonia (mcg/dl) | | 87 | 168 |
| GGTP (IU/L) | | 172 | |
| LDH (U/L) | | 2022 | |
| Triglycerides (mg/dl) | | 111 | |
| Ferritin (mcg/L) | 1320 | | |
| CRP | 54 | 11 | |
| ESR | 65 | 50 | |
| IL-6 (0-7 pg/ml) | | 64 | |
| Blood Culture | No growth | | P. mendocina |
| Covid Antibodies (Spike Protein) | | 147 (positive) | |
| D-dimer (<0.5 mcg FEU/ml) | | 1.74 | |
| Fibrinogen (199—409 mg/dl) | | 229 | |

Learning Points/Discussion: COVID-19 should be kept in mind in fulminant liver failure when other causes have been ruled out.

EP487 / #1375

Topic: AS13. COVID 19 and MIS-C

COVID19 EFFECTS AND FOLLOW-UP IN NEWBORN AND SMALL INFANT

E-Posters

E-POSTER VIEWING

Raquel Neves, Catarina Gouveia, Tiago Silva, Ana Margarida Garcia, Rita Valsassina, Ana Lemos, Maria João Brito

Hospital Dona Estefânia, Infectious Diseases, Lisbon, Portugal

Backgrounds: Although data suggest that COVID19 is generally milder in children under 4 months, factors that influence complications and poor prognosis are not fully understood.

Methods: Retrospective cohort study in infants under 4 months admitted with COVID-19 or SARS-CoV-2 infection, from March 2020 to December 2021. All children had SARS-CoV-2 PCR in naso/oropharyngeal swabs or respiratory specimens. Demographic, clinic, laboratorial, imaging and evolution data was collected. P-value < .05 was considered as statistically significant.

Results: We identified 72 patients with median age of 38 days, 33% were newborns and 58% males. Comorbidities were present in 14 patients, including prematurity (n=8) and congenital malformations (n=4). Also, 82% had family members infected with COVID-19. Fever (69%) and upper respiratory tract symptoms (74%) were the most common symptoms identified. When compared with newborns, fever was more frequently reported in small infants (p-value .016) as well as upper respiratory tract symptoms (p-value .049). Mild-moderate cases were 79%, severe 17% and critical 4%, with one death reported in this last group. In the severe-critical group, the majority of patients (80%) had either comorbidities or another viral co-infection (p-value <.001) and only 27% were newborns. We followed 40 patients on outpatient care and 27 out of 31 (87%) had SARS-CoV-2 antibodies. Additionally, no sequelae associated to COVID19 have been described during follow-up.

Conclusions/Learning Points: COVID-19 in infants under 4 months is usually mild to moderate, although 21% presented a severe-critical course. Poor prognosis was associated with comorbidities or co-infection. Despite the young age, the majority of our patients fully recovered and developed immunity. More studies are needed to assess the future effects of this infection.

EP488 / #1839

Topic: AS13. COVID 19 and MIS-C

COVID-19 IN A CHILD WITH B-CELL LYMPHOBLASTIC LEUKEMIA

E-Posters

E-POSTER VIEWING

Ergena Neziri¹, Laureta Sadedini¹, Gjeorgjina Kuli-Lito², Ferit Zavalani², Mirzana Kapllanaj³, Diana Shtembari², Greta Haxhi¹, Bashkim Nezaj²

¹Mother Teresa Hospital Center, Albania, Pediatric Emergency Department, tirana, Albania, ²Mother Teresa Hospital Center, Albania, Pediatric Infection Disease Department, tirana, Albania, ³Mother Teresa Hospital Center, Albania, Pediatric Onco-hematology Department, tirana, Albania

Title of Case: COVID-19 IN A CHILD WITH B-CELL LYMPHOBLASTIC LEUKEMIA

Background: Severe Covid-19 disease is a great challenge not only in healthy children but also in immunocompromised, especially in patients with hematological malignancies. Diversity in clinical presentation, prognosis and complication are noticed, from mild form to severe acute respiratory syndrome.

Case Presentation Summary: An 4 year-old girl diagnosed with B-cell Acute Lymphoblastic Leukemia before 2 months, while she was receiving his treatment within AEIOP 9205 protocol, was admitted to our department with the complaint of fever since 2 days, cough. Examination: The child was looking sick and pale. No lymphadenopathy and no hepatosplenomegaly was present. Mild catarrhal inflammation of mucous membrane was noticed and auscultation of chest revealed fine crackles, crepitations in both lungs. Oxygen saturation 96-99%. On the third day of admission, the patient started to develop a fever up to 39°C. Her mother was also COVID-19 positive. Laboratory findings: leucocyte 1000/mm³, neutrophil 3 %, Hb 7.8g/dl, PCR 15 mg/dl, high ferritin, D-dimer 1.14 ug/ml, fibrinogen 2.9 g/L, INR 0.94% thrombin time 30s, oropharyngeal swab positive for SARS-COV-2, CT patchy nodular consolidations with peripheral ground-glass opacities and bilateral pneumonia. The patient was hospitalized 2 weeks. The following therapy was applied: cefotaxime, amikacin, acyclovir, fluconazole, bactrim, PFN, albumin. After 2 weeks of treatment the oropharyngeal swab for SARS COV-2 turned negative. She recovered without sequelae and was discharged after clinical conditions and biochemical parameters improved.

Learning Points/Discussion: Hemato-oncology children with COVID-19 are not likely to develop a severe form of SARS-COV-2 due to a weaker immune response which limits the trigger of the inflammatory reaction that is required to cause the damage of disease and the fact that immunocompromised patients are often socially isolated, limiting the chances of them contracting the disease.

EP489 / #863

Topic: AS13. COVID 19 and MIS-C

COMPARISON OF SEVERE VIRAL PNEUMONIA CAUSED BY SARS-COV-2 AND OTHER RESPIRATORY VIRUSES AMONG MALAYSIAN CHILDREN DURING THE COVID-19 PANDEMIC

E-Posters

E-POSTER VIEWING

David Ng¹, Kah Kee Tan², Grace Ting¹, Chin Ling¹, Nf Fadzreena¹, Sf Tan¹, S Thayasheri¹, Nz Emylia¹, B Suhaila¹, Yi Lee¹, Mn Airena¹

¹Hospital Tuanku Ja'afar Seremban, Pediatric, Seremban, Malaysia, ²Perdana University School of Medicine, Paediatrics, Seremban, Malaysia

Backgrounds: Control strategies implemented during the pandemic brought change in the ecology of common childhood respiratory viruses. We performed a retrospective study on the clinical and epidemiological aspects of severe viral respiratory infections during the peak of the COVID-19 pandemic in the state of Negeri Sembilan, Malaysia.

Methods: We included 111 children aged ≤ 12 years who were admitted to the pediatric respiratory ward or pediatric intensive care unit (PICU) between 1 April 2021 and 31 October 2021 with a diagnosis of severe SARS-CoV-2 pneumonia or severe pneumonia due to other viruses (OV). The clinical manifestations, nasopharyngeal swab results and outcomes of these two groups were analyzed and compared.

Results: 97 (87.4%) of patients had a single viral pathogen detected. The most common single pathogen detected was human rhinovirus/enterovirus (HRV/EV, $n = 40$, 36.6%), followed by SARS-CoV-2 ($n=27$, 24.3%) and respiratory syncytial virus (RSV, $n = 26$, 23.4%). Patients with severe SARS-CoV-2 pneumonia exhibited lower proportions of cough, rhinorrhea and adventitious breath sounds when compared to OV group ($p < 0.05$). The proportion of patients who required admission to the PICU, non-invasive ventilation or mechanical ventilation was lower in the SARS-CoV-2 group ($p < 0.05$) and the median duration of oxygen therapy was lower in the SARS-CoV-2 group ($p < 0.05$). There was no difference in the duration of hospitalization and no mortality were reported in both groups.

Conclusions/Learning Points: There were 3 major viruses circulating during the COVID-19 pandemic in 2021 which were causing severe pneumonia in children, namely HRV/EV, SARS-CoV-2 and RSV. COVID-19 results in a less severe disease when compared to other respiratory viruses which were circulating during the study period.

EP490 / #1439

Topic: AS13. COVID 19 and MIS-C

COMPARISON OF ACUTE PNEUMONIA CAUSED BY SARS-COV-2 AND INFLUENZA A IN CHILDREN: A RETROSPECTIVE COHORT STUDY

E-Posters

E-POSTER VIEWING

E Ntempis-Zangogiannis¹, Maroula Tritzali¹, Maria Noni¹, Athanasios Michos¹, Konstantinos Douros², Vassiliki Spoulou¹

¹"Aghia Sophia" Children's Hospital, Division Of Infectious Diseases, First Department Of Pediatrics, Medical School, National And Kapodistrian University Of Athens, Athens, Greece, ²University General Hospital "Attikon", Third Department Of Pediatrics, School Of Medicine, National And Kapodistrian University Of Athens, Athens, Greece, Athens, Greece

Backgrounds: Acute pneumonia caused by SARS-CoV-2 in children is a rare clinical manifestation. Its differences from other viral causes such as alpha influenza virus have not been clarified yet. Our aim was to detect differences in clinical and epidemiological features between the two clinical entities.

Methods: We retrospectively studied children 0-16years old, hospitalized with pneumonia due to SARS-CoV-2 (group A) from January 2020 to December 2021 and due to influenza A (group B) from the 2019-2020 seasonal outbreak at the largest tertiary public hospital of Athens, Greece.

Results: Twenty-three (group A) and 19 (group B) patients were included, predominantly boys (69.6% and 73.7%, $p=0.769$). Group A were of older median age (13 vs 2.3 years, $p=0.029$). Comorbidities were reported in both groups (26% vs 21%, $p=0.703$) with obesity being the most common in group A. Group B experienced more often cough and rhinitis ($p=0.024$ and $p<0.001$, respectively). Group A presented with significant leukopenia, lymphopenia and elevated liver enzymes ($p=0.001$, $p=0.002$ and $p=0.015$, respectively). Three patients from Group A experienced silent hypoxia. Radiological findings in chest X-ray did not differ significantly between groups ($p=0.555$). Ground glass opacities were present in all group A computed tomographies (5/5). Group A required increased oxygen support (52.2% vs. 26.3%) and received less antibiotics (69.5% vs 89.5%) and antivirals (52.2% vs 63.2%), but the difference was not statistically significant. In group A three ICU admissions and one death was reported and 2 patients experienced long-term complications. One patient from group B required ICU admission.

Conclusions/Learning Points: Acute pneumonia caused by SARS-CoV-2 seems to have distinct clinical, laboratory and radiological features that might require different management from Influenza A. Further research is required to verify these results in other populations.

EP491 / #1405

Topic: AS13. COVID 19 and MIS-C

MULTISYSTEM INFLAMMATORY SYNDROME IN CHILDREN (MIS-C) IN A PATIENT WITH CHEMOTHERAPY-INDUCED PANCYTOPENIA

E-Posters

E-POSTER VIEWING

Magdalena Okarska-Napierała, Ernest Kuchar

Medical University of Warsaw, Department Of Pediatrics With Clinical Assessment Unit, Warsaw, Poland

Title of Case: Multisystem inflammatory syndrome in children (MIS-C) in a patient with chemotherapy-induced pancytopenia

Background: Multisystem inflammatory syndrome in children (MIS-C) is a rare, severe, late complication of SARS-CoV-2 infection which develops usually in otherwise healthy children. Exclusion of other infectious diseases is one of its diagnostic criteria. However, MIS-C may occur in chronically ill children, and its course may be more insidious then. We present a case of a boy with Ewing sarcoma who developed MIS-C and sepsis during chemotherapy-induced pancytopenia.

Case Presentation Summary: A 14-year-old boy with Ewing sarcoma of the scapula was diagnosed with asymptomatic SARS-CoV-2 infection on 26.03 and received chemotherapy on days 30.03-3.04 (vincristine, temozolomide). On 8.04, he was readmitted to the hospital due to weakness, inability to swallow solids, severe vomiting, rash, and slightly elevated body temperature. On admission, he was severely dehydrated, with pancytopenia and high inflammatory markers (CRP 20 mg/dL), the latter present chronically due to the inflammatory tumor. Blood cultures were initially negative. On 10.04, his general condition deteriorated, with fever and tachycardia – he received broad-spectrum antibiotic and antifungal therapy, and *E. cloacae* was isolated from two consecutive blood cultures. After transient, partial improvement, on 12.04, the boy developed severe abdominal pain with diarrhea, peritoneal signs, conjunctivitis, red lips, edema of the hands and feet and met the criteria of MIS-C. He received intravenous immunoglobulins and steroids and recovered within a few days, with complete resolution of swallowing difficulties, abdominal pain, conjunctivitis, rash, and normalization of inflammatory markers.

Learning Points/Discussion: Children with a severely damaged immunological system may develop MIS-C. The coexistence of MIS-C and sepsis is possible, with unclear cause-and-effect relation between those two entities.

Topic: AS13. COVID 19 and MIS-C

CHARACTERISTICS OF SARS-COV-2 INFECTION IN CHILDREN AND ADOLESCENTS IN A HIGH-COMPLEXITY PUBLIC HOSPITAL IN BRAZIL

E-Posters

E-POSTER VIEWING

Marcelo Otsuka¹, Eitan Berezin², Tatiane Moraes³, Helmar Verlangieri⁴

¹Darcy Vargas's Children Hospital, Infectious Diseases, São Paulo, Brazil, ²Santa Casa, Pediatric, São Paulo, Brazil, ³Unicid, Pediatric, São Paulo, Brazil, ⁴Darcy Vargas Children's Hospital, Infectology, São Paulo, Brazil

Backgrounds: Sars-CoV-2 infection determines the COVID-19 pandemic since January 2020 and represents, until January 1, 2022, more than 288.6 million notifications worldwide and 5.4 million deaths worldwide. Objectives: Review of clinical and laboratory characteristics in children and adolescents admitted in a public hospital in the State of São Paulo, Brazil.

Methods: Patients with epidemiology or clinical manifestations suggestive of SARS-CoV-2 infection, between April 1, 2020, and June 2, 2021, at the Darcy Vargas Children's Hospital, were submitted to RT-PCR for SARS-COV-2. In addition, patients in surgical programming were also submitted to RT-PCR for SARS-COV-2 as screening.

Results: 2047 RT-PCR tests were obtained with 190 positives (9,28%), with 60.1% male and 39.9% female, with 190 positives cases and 81 hospitalizations, of which 15 required ICU. The main clinical manifestations present in hospitalized patients were: Fever 53(65,3%), Cough 36(44,4%), Respiratory distress 29(35,8%), Vomiting 20(24,7%), Abdominal pain 15(18,5%) and Diarrhea 12(14,8%). In non-hospitalized patients, fever 25(24,5%), cough 16(15,7%) and abdominal pain 6(5,9%) were the most frequent findings. The presence of comorbidities occurred in 120(63,5%) patients. Being 21 with severe kidney disease (17,5%), Oncological diseases 21(17,5%), Asthma 19(15,8%), Sickle Cell Anemia 14(11,3%), Diabetes Mellito 10(8,3%), congenital malformations 10(8,3%), neurological diseases 11(9,2%) and another 20(16,7%). Presence of gastrointestinal manifestations (diarrhea, vomiting and/or abdominal pain) suggested worse evolution. In hospitalized patients, secondary infection occurred in 36.9%. Leukocytes greater than 15,000/mm³ were significant for determining associated bacterial infection. Lymphocytes smaller than 5,000/mm³ had a 2.4 times higher risk of ICU admission.

Conclusions/Learning Points: COVID-19 infection in children, even with comorbidities, although less severe and less frequent than in adults, can have important consequences. Sharing information about the behavior of coronavirus infection in the pediatric population is essential.

EP493 / #1366

Topic: AS13. COVID 19 and MIS-C

COVID-19 NATIONAL ONLINE TRAINING OF SCHOOL TEACHING EMPLOYEES. REINFORCING THE PREPAREDNESS OF THE EDUCATION SYSTEM IN CYPRUS.

E-Posters

E-POSTER VIEWING

Elias Margadjis¹, Aliko Phylactou Kountouri¹, Athena Michaelidou², Modestina Modestou², Irene Cotter³, Panagiota Tandele³, Ioanna Gregoriou³, Christos Charalambous³, Valentinos Silvestros³, Olga Kalakouta³, [Zoi Dorothea Pana](#)⁴

¹Ministry of Education, Culture, Sport and Youth, Health And Safety Office, Nicosia, Cyprus, ²Ministry of Education, Culture, Sport and Youth, Cyprus Pedagogical Institute, Nicosia, Cyprus, ³Ministry of Health, Epidemiological Surveillance Unit, Nicosia, Cyprus, ⁴European University of Cyprus, Medical School, Nicosia, Cyprus

Backgrounds: The COVID-19 pandemic has caused one of the greatest disruptions to education. To prevent the virus' circulation within the school premises and to ensure the students' right to education, risk communication activities among school stakeholders have been suggested. The aim of the study was to implement a national COVID-19 risk communication initiative through interactive online courses to mitigate the effects of current and future infectious diseases' outbreaks.

Methods: A national educational platform for online training courses targeting school stakeholders was implemented, as an initiative of the Ministry of Health, the Ministry of Education Culture, Sport and Youth under the auspices of the Ministry of Education Health/ Safety Office, the Pedagogical Institute and the National COVID-19 Committee. The target audience were the School Principals of the school institutions, teachers and parents. The educational aim focused on COVID-19 safety protocols, nonpharmaceutical interventions (NPIs) and vaccination. The module included a 30 min presentation followed by interactive discussion. A questionnaire was disseminated to provide feedback (score 1-5) and make improvement suggestions.

Results: During October-November 2021, seven online courses were completed. The total number of participants were 1174, 408 of which were principals of pre-primary and primary schools (34.8%) and 127 principals of secondary schools (10.8%). The total number of the questionnaire responders were 413 (rate 35.2%). The feedback included usefulness to confront with COVID-19 challenges at school (40% found the course useful). Regarding NPIs compliance, 83.8% reported that after the course they would implement mask wearing in schools. The most common suggestions were to expand the courses to children and include psychosocial support and infection control training.

Conclusions/Learning Points: The present results reveal the continuous need to support emergency preparedness plans and raise awareness in the school premises.

EP494 / #1059

Topic: AS13. COVID 19 and MIS-C

EPIDEMIOLOGICAL AND CLINICAL CHARACTERISTICS OF MULTISYSTEM INFLAMMATORY SYNDROME IN CHILDREN (MIS-C) IN ARMENIAN HOSPITAL

E-Posters

E-POSTER VIEWING

Aida Papikyan, Tamara Simonyan, Tehmine Ghalechyan, Lusine Avetyan, Hrachuhi Ghazaryan
Wigmore clinic, Pediatric, Yerevan, Armenia

Backgrounds: Multisystem inflammatory syndrome (MIS-C) is a severe hyperinflammatory condition in children associated with antecedent SARS-CoV-2 infection. We report a cohort of patients diagnosed MIS-C at our clinic.

Methods: We included patients hospitalized at Wigmore clinic, Armenia, from 25/06/20 to 11/11/21, with diagnosis MIS-C based on WHO criteria.

Results: The total number of patients was 18, 2(11%) were under 1 year old, the median age was 5 years (0,8-14y), 15(83%) was male. 17(94%) had positive anti-SARS-CoV2 antibodies. 2/17(11%) patients reported a known contact and 2/17(11%) had confirmed covid infection 3-4 week prior the admission, 1/18(5%) with negative antibodies and PCR had covid-positive grandfather parallel of his hospitalization. 7(39%) patients demonstrated Kawasaki-like disease. Presentation: Fever (3-24days) was reported in all cases, 15(83%) children had mucocutaneous signs and 7(39%) had cardiac involvement from which 3(17%) coronaritis without residual aneurysm formation and 1(5%) myocarditis with elevated troponin(121pg/ml). 5 patients(28%) reported gastrointestinal symptoms. 1 case complicated with acute kidney injury. Lab work up revealed: elevated ESR(16-45mm/h, mean-32) and CRP(19-242mg/l mean-110) in all patients and high D-dimer(>250ng/ml) in 17(94%) cases (350-4520ng/ml, mean-1493). Treatment: 5 patients(28%) received IVIG, 5(28%) – IV steroids alone and 6 patients(33%) required both. 3(17%) patients had self-limited disease. All patients received aspirin.

Conclusions/Learning Points: MIS-C have different manifestations from self-limited disease to life-threatening condition and requires high vigilance among health care provides.

EP495 / #1489

Topic: AS13. COVID 19 and MIS-C

VIRAL CO-INFECTION IN PATIENTS WITH SARS-COV-2

E-Posters

E-POSTER VIEWING

Idoia Pinedo¹, Carmina Guitart², Iolanda Jordan², Sara Bobillo-Perez², Mònica Girona-Alarcon², Mariona Fernández De Sevilla¹

¹Hospital Sant Joan de Déu, Paediatrics, Esplugues de Llobregat, Barcelona, Spain, ²Hospital Sant Joan de Déu, Intensive Care Unit, Barcelona, Spain

Backgrounds: There is low evidence of the impact of co-infection in patients with SARS-CoV-2 regarding the need for supportive therapy and comorbidity. The aim was to describe viral co-infection in patients with SARS-CoV-2. To compare differences between ward vs ICU patients and between adult and children population.

Methods: Prospective, observational study. Patients with SARS-CoV-2 infection admitted to our Hospital from March 2020 to September 2021 were included. Demographical data was collected. Clinical, microbiological and laboratory findings, treatment and outcomes were analyzed.

Results: 126 patients were recruited, 60 adults with median age of 37.5(IQR 30-46) years and 66 children with median age of 8(IQR 2-13) years. The common symptom on both groups was fever, 55(83.3%) children vs 55(91.7%) adults. Dyspnea and cough were more common in adults, in 56(93.3%) and 46(76.7%), respectively. Abdominal pain and diarrhea were more frequent in children 22(33.3%) and 28(42.4%), respectively. Diagnosis of SARS was achieved in 51(85%) adults. Twenty(30.3%) children were diagnosed of Multisystem Inflammatory Syndrome in Children (MIS-C) and 24(36.4%) had mild infection. Viral co-infection was diagnosed in 6(0.09%) children, not in adults. The viruses detected were: rino/enterovirus in 4 patients, parainfluenza in 1 and Influenza in another one. Bacterial co-infection was diagnosed in 5(0.08%) adults and 5(0.08%) children. Regarding respiratory support, 51.7% adults vs 10.6%children ($p<0.01$) needed invasive ventilation. Regarding hemodynamic support, 28.3% adults vs 18.2% children. The median PICU length of stay (LOS) was 9.5(IQR 5-14.25)days in adults and 5(IQR 2.75-6.25)days in children, ($p<0.01$). Hospital LOS was 18(IQR 11-28.5) days in adults vs 5.5(IQR 3-10) days in children, ($p<0.01$).

Conclusions/Learning Points: There were differences in respiratory and hemodynamic support, LOS and co-infection between children and adult patients. Viral co-infection was more frequent in children patients.

EP496 / #468

Topic: AS13. COVID 19 and MIS-C

PAEDIATRIC INFLAMMATORY MULTISYSTEM SYNDROME ASSOCIATED WITH COVID-19: A SIX-YEAR-OLD GIRL WITH NEUROPSYCHIATRIC SYMPTOMS MANIFESTATION

E-Posters

E-POSTER VIEWING

Kamilė Plėšnytė- Čapkauskienė¹, Lorian Kilaitė², Božena Paškevič², Paulius Kalibatas²

¹Vilnius university hospital Santaros Klinikos, Child Development Center, Vilnius, Lithuania, ²Vilnius university hospital Santaros Klinikos, Paediatrics Centre, Vilnius, Lithuania

Title of Case: Paediatric inflammatory multisystem syndrome associated with COVID-19: a six year old girl with neuropsychiatric symptoms manifestation

Background: To present and discuss a case of a patient with neuropsychiatric symptoms following the COVID-19 infection with Paediatric Inflammatory Multisystem Syndrome (PIMS) as a complication.

Case Presentation Summary: 6 years old patient was diagnosed with PIMS based on the following findings: positive SARS-CoV-2 IgG antibodies, anamnesis includes patient's mother diagnosed with COVID19 one month earlier; fever; dysfunction of multiple organ systems; hallucinations, partially positive Babinski sign, bad coordination; splenomegaly, worsening thrombocytopenia; cardiac repolarization abnormalities; one episode of abdominal pain with emesis. The MRI performed during the first hospitalization exhibited abnormalities compatible with PIMS. The subsequent test during the second hospitalization showed improved dynamics. After the treatment of IVG (2mg/kg), steroids and aspirin (75g/day, p/os) the patient improved and was discharged. After a month she was readmitted with persistent auditory and visual hallucinations and sleep disorders. After presenting a more detailed family anamnesis with impact towards differential diagnosis the patient was hospitalized at the children psychiatric department. 6 months later the detailed psychiatric examination showed absence of symptoms. The patient had been overseen by a children's cardiologist. No cardiovascular pathology was detected at the time of examination. 9 months later the patient started primary school with good adaptation.

Learning Points/Discussion: we've described a case of PIMS following the COVID19 infection which resolved after several months. Gastrointestinal symptoms of PIMS resolved in 1 week of active treatment, cardiovascular in 2 weeks. We suggest that familial anamnesis helps with differential diagnosis.

EP497 / #1275

Topic: AS13. COVID 19 and MIS-C

COMMUNITY CONTAMINATION DYNAMICS BY ALPHA-VARIANT-SARS-COV-2 IN CHILDREN AND ADULTS

E-Posters

E-POSTER VIEWING

Anne Ploin¹, Luc Panetta², Mehdi Benchaib³, Laetitia Henaff⁴, Antoine Ouziel², Zenaida Iordan², Laurence Josset⁵, Etienne Javouhey², Bruno Lina⁶, Yves Gillet², Jean-Sebastien Casalegno⁵, Dominique Ploin²

¹University of Oxford, Oxford Internet Institute, Oxford, United Kingdom, ²Hospices Civils de Lyon - Hopital Femme Mere Enfant, Service De Reanimation Et Urgences Pediatriques, Bron, France, ³Hospices Civils de Lyon, Service De Médecine Et De La Reproduction, Bron, France, ⁴Hospices Civils de Lyon, Service Hygiène, Epidémiologie Et Prévention, Lyon Cedex, France, ⁵Hospices Civils de Lyon, Laboratoire De Virologie, Lyon, France, ⁶Hospices Civils de Lyon, Institut Des Agents Infectieux - Hopital De La Croix-rousse, Lyon, France

Backgrounds: A previous study matched adult and pediatric groups to show that children were not the core source of household contamination in ancestral SARS-CoV-2 infections. We discussed the limitations to use of the influenza model of contamination for ancestral SARS-CoV-2 infections, highlighted the central role of adults, advocating a reduction in the restrictions imposed on children, e.g., school closures. To control for variants, we extended the study to an Alpha-variant-SARS-CoV-2 cohort.

Methods: General methods were described in abstract N°1237. Additionally, all index patients and their contaminators were Alpha-variant-RT-PCR+; 5 age-range quotas were used to limit the over-representation of neonatal cases; adult age intervals were minimally extended to ensure matching feasibility; and interval delay from symptom onset was also minimally extended.

Results: Twenty-nine children with February-June 2021 onset of disease were included. In these households, the first contaminators were: children in 6 cases (21%), adults in 20 cases (69%), and unidentified in 3 cases (10%). In 9 out of 29 cases (31%), the first contaminated household member was a child. Out of the 48 matched adults, first contaminators were: children in 8 cases (14%) and adults in 35 cases (60%), and unidentified in 15 cases (29%). In 8 out of 58 cases (14%), the first contaminated household member was a child [OR (not contaminated by opposite group/contaminated by opposite group)=0.072 (95%CI: 0.024-0.213, p<0.001)].

Conclusions/Learning Points: Our study extended previous work on ancestral SARS-CoV-2 to show that children were not the core source of household contamination in Alpha-variant-SARS-CoV-2. Our conclusions call for adapting the initial severe social measures targeting children in this pandemic. Community contamination remains mainly driven by adults, and the heavy social restriction of children should still be avoided as far as possible.

EP498 / #1845

Topic: AS13. COVID 19 and MIS-C

TREND OF COVID19 INFECTION IN CHILDREN DISCHARGED FROM THE PEDIATRIC EMERGENCY DEPARTMENT OF MAGENTA

E-Posters

E-POSTER VIEWING

Alessandro Porta, Marta Bellini, Francesca Lizzoli, Luciana Parola
Hospital of Magenta (Milan, Italy), ASST Ovest Milanese, Pediatric, Neonatal And Neonatal Pathology Units, Magenta (Milan), Italy

Title of Case: TREND OF COVID19 INFECTION IN CHILDREN DISCHARGED FROM THE PEDIATRIC EMERGENCY DEPARTMENT OF MAGENTA

Background: Since April 2020 the use of nasopharyngeal swabs to detect SARS-CoV-2 RNA has been progressively implemented in patients with respiratory infection. We collected data on all nasopharyngeal swabs performed in children who referred to our pediatric emergency department from April 2020 to February 2022, done to suspected respiratory viral infection and then discharged at home in a fiduciary isolation regimen waiting for the result. All data from patients admitted have not been considered in this study.

Case Presentation Summary: During the study period, 10678 children referred to different causes to our pediatric emergency department, and 9735 of them (91.1%) were discharged at home (for both medical and surgical diagnosis). 1843 of them (18.9%) were discharged waiting for the swab result, done to suspected viral respiratory infection. The swab resulted positive in 198 children (10.7% of all the swabs performed): all these families were contacted from the pediatrician. A higher positivity rate in children discharged was observed on November 2020 (24.3%) and from December 2021 to February 2022 (31.4%), with a peak on January 2022 (46.5%). From September 2020 the use of nasopharyngeal swabs increased in children with suspected viral infection, with a peak on January 2022 (done in 35.2% of patients discharged).

Learning Points/Discussion: The use of nasopharyngeal swab to detect SARS-CoV-2 RNA progressively increased since the beginning of the pandemic, and in particular from September 2020. The involvement of pediatric age in COVID19 infection had a low impact in the first phase of pandemic, with an increase with new variants in the last winter season, in particular starting from December 2022.

EP499 / #1074

Topic: AS13. COVID 19 and MIS-C

WHICH IS THE MOST AFFECTED COMPONENT OF THE FAMILY HEALTH-RELATED QUALITY OF LIFE DUE TO PEDIATRIC COVID-19 IN LATVIA?

E-Posters

E-POSTER VIEWING

Zanda Pucuka^{1,2}, Anija Meiere^{2,3}, Anda Kivite-Urtane⁴, Liene Smane^{2,3}, Ieva Roge³, Iveta Racko³, Lizete Klavina³, Jana Pavare^{2,3}

¹Children's Clinical University Hospital, Department Of Emergency Medicine, Riga, Latvia, ²Riga Stradins university, Department Of Pediatrics, Riga, Latvia, ³Children's Clinical University Hospital, Department Of Infectology, Riga, Latvia, ⁴Riga Stradins University, Department Of Public Health And Epidemiology, Riga, Latvia

Backgrounds: Aim of the study was to explore parents' perspective about the paediatric COVID-19 and family health-related quality of life (FHRQoL).

Methods: Qualitative face-to-face semi-structured, in-depth interviews with 15 parents of 20 COVID-19 patients (12 girls, 8 boys; 17 outpatient, 3 inpatient) aged 1 month – 15 years were conducted from November 2020 to April 2021. Interviews were recorded and transcribed. Thematic analysis was used for data processing.

Results: A myriad of emotions was coming up in interviews. First, sense of powerlessness, learning the diagnosis even though all the measures of epidemiological safety had been taken. Second – fear that other children would get sick. Third – fear of being unable to care for a child in case of parent's own illness. Fourth – fear of unpredictability of the course of the child's disease and symptoms observed, mostly, shortness of breath, fatigue, and the apathy. Fifth – worries about long COVID-19 as several children experienced learning difficulties, fatigue, and other post-acute symptoms. Sixth – confusion about the care provided – too many calls or lack of attention from the family physician. Seventh – anxiety due to the contradictory information flow from specialists and throughout media. Eighth – stress due to the threatening relationship breakdown. Ninth – stress due to the disrupted work schedule followed by loss of income and additional duties at home. Tenth – fear of social isolation, condemnation as people who have not complied with the implemented security measures.

Conclusions/Learning Points: Emotional well-being is one of the most affected components of the FHRQoL regarding paediatric COVID-19 infection in Latvia. Findings indicate an increased need in dedicated health services and highlights the necessary improvements in health communication and organization of health care and social support services.

Topic: AS13. COVID 19 and MIS-C

COVID-19 PANDEMIC - WHAT CHANGED IN THE EPIDEMIOLOGY AND HOSPITALIZATION RATES FOR MENINGITIS

E-Posters

E-POSTER VIEWING

Joana Queirós¹, Cláudia Correia¹, Juliana Cardoso¹, Paula Vieira¹, Alexandre Fernandes², Laura Marques²

¹Centro Materno Infantil do Norte, Centro Hospitalar Universitário do Porto, Pediatrics, Porto, Portugal, ²Centro Materno Infantil do Norte, Centro Hospitalar Universitário do Porto (CHUPorto), Pediatric Department, Infectious Diseases And Immunodeficiencies Unit, Porto, Portugal

Backgrounds: Meningitis remains a relevant cause of hospitalization, even after the introduction of new vaccines in the immunization schedule. The COVID-19 pandemic caused changes in the epidemiology of several infectious pathogens and in hospitalization rates for various conditions. The aim is to evaluate its impact on meningitis diagnosis in patients admitted to a third-level pediatric hospital.

Methods: Retrospective and descriptive study of patients admitted from January 2014 to December 2021. Sample was divided in two groups (A vs. B): before and after March 2020. Statistical analysis in SPSS 27.

Results: A total of 210 patients were included; 133 (63,3%) were male and 158 (76.7%) had >24 months old. Viral meningitis were more frequent (124; 59.0%) and 31 (14.8%) had bacterial meningitis. Almost all cases were in group A (200; 95,2%) with an average of 30 episodes/year. Non-viral pathogens more frequently identified were *N. meningococcus* and *S. pneumococcus* in group A and *E. coli*, *H. influenzae* and *M. tuberculosis* in group B. Patients in group B were younger and bacterial meningitis more frequent (OR 1.35 (p<0.001, 95% IC 1.09-1.66)).

| Variable | Total (n=210) | Group A (n=200) | Group B (n=10) | p value |
|---|-----------------|-----------------|-------------------|---------|
| Age, months (median, IQ) | 57 (25.8-83.2) | 58 (27-55.8) | 17 (5-30.5) | p<0.01 |
| Hospitalization length, days (median, IQ) | 3 (2-6) | 3 (2-6) | 14 (9-21.5) | p<0.01 |
| Leucocyte CSF count, mg/μL (median, IQ) | 237 (50-900) | 198 (47-755) | 3555 (1130-5738) | p<0.01 |
| C-reactive protein, mg/L (median, IQ) | 20.5 (6.9-40.3) | 18 (6.5-37.7) | 41.3 (22.5-147.1) | p=0.01 |

Conclusions/Learning Points: COVID-19 has changed the epidemiology of infectious diseases with a decrease in admissions for meningitis after March 2020. After this point most cases were bacterial meningitis, which explains the other findings. These changes are presumably related to limited social interaction and generalized mask use in adolescents and adults.

EP501 / #627

Topic: AS13. COVID 19 and MIS-C

COVID-19 LOCKDOWN: IMPACT ON CHILDREN WITH RECURRENT WHEEZING AND ASTHMA IN SPAIN

E-Posters

E-POSTER VIEWING

Zarife Daoud¹, Marcelo Razquin², Alvaro Diaz², Isabel Romero³, Paula Ventura²

¹Emirates Specialty Hospital, Pediatrics, Dubai, United Arab Emirates, ²HM NENS, Pediatria, Barcelona, Spain, ³HM Hospitales, Pediatria, Madrid, Spain

Backgrounds: Background and objective: The effect of lockdown measures due to COVID-19 pandemic in children with respiratory underlying conditions are still unclear. We analyzed the impact of lockdown measures in the treatment and control of children with asthma and preschool wheeze during the first wave of COVID-19.

Methods: observational study carried out in children with recurrent wheezing or asthma before and after the implementation of the lockdown by using: a questionnaire aimed to examine pre-existing respiratory disorders, step treatment (according to Spanish Guide for Asthma Management) and level of asthma control before/after lockdown (CAN questionnaire), COVID history and laboratory testing including IgG SARS-CoV-2.

Results: We enrolled 475 asthmatic and preschool wheezers (60.6% males), mean age 5.6 years. There were no differences in asthma treatment comparing both periods, since 81.7% maintained the same treatment ($p=0.103$). According to CAN questionnaire 87.7% remained well controlled during confinement. Nearly a third of children (34.9%) needed reliever treatment, mainly in older children. Determination of IgG SARS-CoV-2 was performed in 233 children (49.1%) of whom 17 (7.3%) tested positive. Seven patients positive to IgG SARS-CoV-2 were assisted in the emergency department and two required hospital admission.

Conclusions/Learning Points: During the COVID-19 lockdown most of the children with asthma and recurrent wheezing maintained their preventive treatments unchanged, showing good therapeutic adherence. As a consequence, they remained well controlled from their underlying disease. Children with positive IgG SARS-CoV-2 did not show severe signs or symptoms of COVID-19 disease, although we observed a significant increase in pediatric hospital admissions and attendances to urgent care settings.

EP502 / #1212

Topic: AS13. COVID 19 and MIS-C

DISEASE CHARACTERISTICS IN CHILDREN WITH COVID-19 BEFORE AND DURING THE DELTA-VARIANT, IN BRASOV, ROMANIA

E-Posters

E-POSTER VIEWING

Flavia Rochman¹, Oana Falup-Pecurariu², Laura Dima³, Magdalena Birtar³, Constantin Grigorita⁴

¹Children Emergency Hospital Brasov, General Pediatrics, Braşov, Romania, ²Transilvania University, Faculty Of Medicine, Brasov, Romania, ³Sacele Municipal Hospital, Pediatrics, Sacele, Romania, ⁴"Dr. Aurel Tulbure" Municipal Hospital Fagaras, Pediatrics, Fagaras, Romania

Backgrounds: COVID-19 pandemic caused by severe acute respiratory syndrome coronavirus 2 (SARS-CoV-2) has represented a major public health crisis in Romania and worldwide. Compared to previous strains, delta-variant has been a burden for the local pediatric healthcare system.

Methods: - retrospective observational study conducted between May-December 2020 and January–March and September–November 2021 - study included 314 children aged <18 years, diagnosed and hospitalized in 3 different paediatric units in the region (inclusion criteria was a positive RT-PCR result)

Results::

Demographic data: Total of patients = 314

| | | |
|-------------------------------|--|----------------------------|
| | No. patients in 2020 = 172 | No. patients in 2021 = 142 |
| Gender | M = 41.86% ; F = 58.14% | M = 60.56% F = 39.44% |
| Residence | Rural 33.13% Urban 66.87 % | Rural 29.57% Urban 70.43% |
| Mean age | 7.5 years (range 9 days – 18 yr) A higher percentage of patients in the 0 – 5 yr old age interval in 2021 cohort in contrast with 2020. (P=0.0001) | |
| Symptoms | Most patients symptomatic. Bigger % of asymptomatic in the first waves compared to delta (27.9% in 2020 vs 41.6% in 2021). More cough, GI tract symptoms, cephalgia A cluster of patients with croup-like symptoms (barking cough) in 2021 cohort in contrast with 2020. | |
| Underlying medical conditions | 15% of patients (cystic fibrosis, neurological illness, malnutrition) | |
| Laboratory findings | Normal WBC majority of cases. High ferritin values and high D-Dimers were also found in similar cases. chest x-ray or non-specificic interstitial abnormalities in most cases. | |
| Follow-up | No MIS-C was reported afterwards. | |

Conclusions/Learning Points: Delta variant proved to be more contagious in children, with a higher hospitalization rate. More symptomatic cases requiring appropriate treatment were seen in practice.

EP503 / #1507

Topic: AS13. COVID 19 and MIS-C

MENTAL STATUS ALTERATION AFTER COVID19 VACCINE IN AN ADOLESCENT

E-Posters

E-POSTER VIEWING

Sara Rodrigues, Rosário Cunha, Inês Azevedo, Graça Loureiro, Joana Cardoso
Centro Hospitalar Entre Douro e Vouga, Pediatrics, Santa Maria da Feira, Portugal

Title of Case: MENTAL STATUS ALTERATION AFTER COVID19 VACCINE IN AN ADOLESCENT

Background: Comirnaty® is an anti-COVID19 mRNA vaccine. The side effects reported during the clinical trials were relatively benign, mostly local pain and swelling, headache, muscle and joint pain, chills, fever, and diarrhea

Case Presentation Summary: A 14-year-old female was admitted to the ER, the day after her 2nd dose of Comirnaty®, with fever, headache, dizziness, and progressive deterioration of neurological status with periods of confusion since that morning. At admission she presented with fever and hypotension, alert but agitated and disoriented to person and space. Coordination tests and gait evaluation couldn't be performed but the remaining exam was normal. Complete blood count and coagulation parameters were normal. C-reactive protein was 7.6 mg/L. The head CT was also normal. The opening cerebrospinal fluid (CSF) pressure was 15cmH2O. The CSF was acellular, with normal glucose and protein levels. Urine drug screening was negative, except for benzodiazepines (used for sedation). She started treatment with iv acyclovir and ceftriaxone and was admitted to the pediatric ward for further investigation. By the following day, she had returned to her normal behavior. Head MRI was performed and despite metallic artifacts (braces), no changes were detected. SARS-CoV2 PCR, blood and CSF culture, and Multiplex PCR Assay were negative as well as oligoclonal bands in the CSF. After other conditions were excluded, the symptoms were assumed to be likely a consequence of the anti-COVID19 vaccine and reported to the National Authority of Medicines and Health Products (INFARMED).

Learning Points/Discussion: Few cases in the literature describe deterioration of neurological status associated to a COVID19 vaccine, and only in adults. With this case, we aim to create awareness of this possible side effect of COVID19 vaccine in children/adolescents.

EP504 / #1037

Topic: AS13. COVID 19 and MIS-C

SIX MONTH OUTCOMES IN CHILDREN AFTER MULTISYSTEM INFLAMMATORY SYNDROME (MIS-C) ASSOCIATED WITH COVID-19

E-Posters

E-POSTER VIEWING

Ieva Roge¹, Liene Smāne¹, Anda Kivite-Urtāne², Zanda Pucuka³, Anija Meiere¹, Iveta Racko⁴, Lizete Klavina⁴, Jana Pavare⁴

¹Children's Clinical University Hospital, Department Of Infectology, Riga, Latvia, ²Riga Stradins University, Department Of Public Health And Epidemiology, Riga, Latvia, ³Children's Clinical University Hospital, Department Of Emergency Medicine, Riga, Latvia, ⁴Children's Clinical University Hospital, Department Of Pediatrics, Riga, Latvia

Backgrounds: Multisystem inflammatory syndrome in children (MIS-C) is a rare but dangerous complication of COVID-19. The pathophysiology, immunology and long-term clinical outcomes are not yet fully known, and further research is required. The aim of our study is to identify and understand long-term outcomes of MIS-C.

Methods: In this prospective cohort study conducted from January 2021 to December 2021, 30 patients with MIS-C were enrolled. To identify the outcomes, all patients were evaluated in face-to-face visits 2 weeks, 8 weeks, and 6 months after diagnosis using clinical assessment, laboratory testing and cardiological examination.

Results: During the two-week follow up visit 20% (n=6) of children had abnormal clinical findings. Notably, significant increase was seen in these findings at 8-week follow-up (63,3%, n=14). Most often reported symptoms at 8-weeks were cognitive, musculoskeletal and neurological sequelae. At 6-month follow-up only 30% (n=9) of patients had any abnormal clinical findings. During the 2-week visit, 90% (n=27) of patients had abnormal complete blood cell and platelet counts, but 60% (n=18) of children had abnormal inflammatory parameters (D-dimers, ferritin, CRP, Il-6). Significant improvement of hematologic and inflammatory parameters was seen at 8-week (6.7%, n=2) and 6-month (3.3%, n=1) follow-up. In addition, at 2-week follow-up 60% (n=18) of patients had abnormal electrocardiograms, but 13,3% (n=4) patients had abnormal echocardiography, including two patients with diagnosed coronary artery involvement. At 8 week and 6-month follow-up visits all patients had normal cardiological findings.

Conclusions/Learning Points: Abnormal clinical, laboratory and cardiological findings were seen in majority of patients two weeks after MIS-C with significant improvement in following weeks.

EP505 / #964

Topic: AS13. COVID 19 and MIS-C

SAFETY AND FEASIBILITY OF MONOCLONAL ANTIBODY THERAPY IN CHILDREN WITH COVID-19

E-Posters

E-POSTER VIEWING

Lorenza Romani¹, Sara Chiurchiù¹, Francesca Ippolita Calò Carducci¹, Laura Corsi¹, Martina Di Giuseppe¹, Maia De Luca¹, Laura Lancella¹, Leonardo Vallesi², Tiziana Corsetti², Andrea Campana³, Paolo Palma⁴, Paolo Rossi⁵, Stefania Bernardi¹

¹Bambino Gesù Children's Hospital, IRCCS, Immunology An Infectious Diseases Unit, Rome, Italy, ²Bambino Gesù Children's Hospital, IRCCS, Hospital Pharmacy Unit., Rome, Italy, ³Bambino Gesù Children's Hospital, IRCCS, Department Of Paediatrics, Rome, Italy, ⁴Bambino Gesù Children Hospital, Clinical Immunology And Vaccinology Research Unit, Rome, Italy, ⁵Bambino Gesù Children's Hospital, IRCCS, Academic Department Of Paediatrics, Rome, Italy

Title of Case: SAFETY AND FEASIBILITY OF MONOCLONAL ANTIBODY THERAPY IN CHILDREN WITH COVID-19

Background: Children have been less frequently and severely involved than adults, however severe pediatric cases of COVID-19 have been reported. Furthermore a post-infectious inflammatory complication defined multisystem inflammatory syndrome in children (MIS-C) was described 2-4 weeks later from SARS-CoV-2 infection with a multi-organ involvement. There are few data regarding safety or efficacy of monoclonal antibody (MA) treatment for pediatric COVID-19. We report our experience with MA for the treatment of COVID-19 in children.

Case Presentation Summary: Since April 2021 to January 2022 a total of 72 pediatric patients (age 0-18 years) affected by COVID-19 with mild and moderate respiratory symptoms and with risk factors for a severe disease (eg.congenital heart disease, chronic pulmonary disease, genetic syndrome) received monoclonal antibody as treatment. Forty-six received Casirivimab – Imdevimab (23 of them were < 12 y), 22 children were treated with Bamlanivimab-Etesevimab and four patients under 12 years old were treated with Sotrovimab in the suspect of Omicron variant. For children with a weight under 40 kg a reduced dose of each monoclonal antibody was used based on the recorded studies. The most common comorbidity in our cohort was congenital heart disease. There were no significant adverse effects or reactions that required suspension of the infusion such as anaphylaxis, hypotension or dyspnea. No one was readmitted for reasons related to COVID-19 or MIS-C within 30 days after receiving treatment.

Learning Points/Discussion: Our data shows that MA treatment for mild-to-moderate SARS-CoV-2 infection was well tolerated and may be effective in halting progression to severe disease and prevention of hospitalization. Newborn physiologically immunodepressed, patients with comorbidities such as chronic heart and lung disorders may benefit from a prompt treatment with MA.

EP507 / #767

Topic: AS13. COVID 19 and MIS-C

CLINICAL CHARACTERISTICS, TRANSMISSION RATE AND OUTCOME OF NEONATES BORN TO COVID-19-POSITIVE MOTHERS: A PROSPECTIVE CASE SERIES FROM A MIDDLE-INCOME COUNTRY

E-Posters

E-POSTER VIEWING

Marloes Rood^{1,2}, Lisa Ten Kate², Kevin Van 'T Kruys², Navin Boeddha^{2,3}

¹Rijnstate Hospital, Paediatrics, Arnhem, Netherlands, ²Academic Pediatric Center Suriname, Paediatrics, Paramaribo, Suriname, ³Erasmus MC-Sophia Children's Hospital, Pediatrics, Rotterdam, Netherlands

Title of Case: Clinical characteristics, transmission rate and outcome of neonates born to COVID-19-positive mothers: A prospective case series from a middle-income country

Background: COVID-19 negatively affects placental tissue, but data of neonates born to COVID-19-positive mothers is scarce. We aim to describe clinical characteristics, transmission rate, and outcome at 3 months of age. We performed a prospective, multicenter case series from Suriname (South America). We collected clinical data of neonates born to mothers with COVID-19 infection between June 2021 and August 2021. Nasopharyngeal swabs to test COVID-19 were taken within 5 days and 2-3 weeks after birth. Follow up visit took place at the age of three months.

Case Presentation Summary: We enrolled 18 neonates. 18/18(100%) mothers were infected in the third trimester of pregnancy and 10/18(55.6%) had severe COVID-19 infection requiring ICU admission, 2/10(20%) died. 16/18(77.8%) neonates were born after cesarean section and 13/18(72.2%) were born preterm (median 35 weeks, IQR 32+4–38+0). NICU admission was needed in 7/18(38.9%) neonates. Respiratory symptoms occurred in 12/18(66.7%), 5/18(27.8%) were suspected of early-onset sepsis, and 1/18(5.6%) of late-onset sepsis. One preterm neonate developed necrotizing enterocolitis.

Nasopharyngeal swab was positive for COVID-19 in 1/18(5.5%) neonates within 5 days of life and in 0/11(0%) neonates after 2-3 weeks. Follow up showed mild neurodevelopmental delay in 2/14(14.3%) patients.

Learning Points/Discussion: We describe a high proportion of severely ill mothers due to COVID-19 infection with subsequent preterm birth and cesarean delivery. The neonatal clinical course and findings at follow up did not seem to differ from neonates born to COVID-19 negative mothers. Maternal vaccination against COVID-19 is recommended to prevent neonatal risks associated with prematurity and cesarean delivery. Neonatal outcome after maternal COVID-19 infection in the 1st or 2nd trimester of pregnancy should be studied.

EP508 / #1053

Topic: AS13. COVID 19 and MIS-C

COVID-19 AND CORONARY ARTERY DILATION IN PEDIATRIC PATIENTS

E-Posters

E-POSTER VIEWING

Glykeria Rouva, Eleni Vergadi, Ioannis Germanakis
University of Crete, Department Of Pediatrics, Heraklion, Greece

Backgrounds: Pediatric COVID-19 complications include MIS-C and Kawasaki Disease (KD). A probable association of milder COVID-19 forms with coronary artery dilation (CAD) in children remains to be investigated.

Methods: Single center prospective study, including 34 children (20 males, median age 3.1 months, 76% infants) admitted for mildly symptomatic COVID-19 (+nasal PCR) during 10 months (3-12. 2021). KD and MIS-C cases were excluded. Institutional ethics committee approval and informed consent of patients' parents was obtained. High sensitivity troponin (hsTR) and electrocardiogram (ECG) were performed at admission, a detailed echocardiography followed (20 days, range 7-50 days following first symptoms). Coronary artery dilation (CAD) was defined as a Z score (for BSA) ≥ 2 for any segment. + CAD status was associated with patients' data by appropriate statistic tests (SPSS 12.0).

Results: Abnormal CRP, hsTR and ECG abnormalities were observed in 6 (17%), 3 (9%) and 14 (41%) of cases, respectively. CAD was documented in 10 (29.4%) cases: 5 corresponding to mild dilation (z score <2.5) and 5 to small aneurysms (z score <5); 4 received low dose aspirin up to their reevaluation. + CAD cases had higher admission hsTR values (13.2 vs 5.4 pg/ml, $p=0,018$) and lower Hb values (9,5 vs 12 gr/dL, $p=0.003$). A trend (although not significant) of +CAD patients being of younger age, males, with higher admission CRP, thrombocytes and ECG abnormalities was also observed.

Conclusions/Learning Points: A substantial percentage (29%) of pediatric admissions with mild COVID-19 disease demonstrated coronary artery dilation 3 weeks after first symptoms, associated with higher hsTR and lower Hb admission values. Larger scale prospective studies are needed to document the time course of observed CAD in this patient group.

EP509 / #1191

Topic: AS13. COVID 19 and MIS-C

CHARACTERIZATION OF SARS-COV-2 INFECTION IN CHILDREN DURING THE FIRST YEAR OF PANDEMICS

E-Posters

E-POSTER VIEWING

Montserrat Ruiz-García¹, M.àngels Rifà Pujol², Anna Ricart Cumeras², Ma.Jesús Bravo Pulido², Elisabeth Solà Segura², Esperança Macià Rieradevall², Natàlia Sabat Vila², Glòria Pladullers Furriols², Maria Vinyoles Tolosa¹, Meritxell Torrabias Rodas¹, M.Teresa Riera Bosch², Marina Lobaco Soler², Pere Roura Poch³

¹Hospital Universitari de Vic, Paediatrics Department, Vic, Spain, ²Institut Català de la Salut - Catalunya Central, Pediatria Sap Osona, Vic, Spain, ³Hospital Universitari de Vic, Clinical Epidemiology Unit, Vic, Spain

Backgrounds: SARS-CoV-2 infection in children courses with mild and nonspecific symptoms likewise other viral infections, leading to the repeated performance of diagnostic tests and preventive isolations. The aim of this study is to define the clinical features of COVID19 in children of our region, Osona, located in a rural area of Catalonia.

Methods: Prospective observational study. We included a sample of patients <15 years who underwent a SARS-CoV-2 test for clinical suspicion, at the regional hospital and primary care centers of our area, from March 2020 to March 2021. We registered epidemiological features, main symptoms (fever, upper respiratory tract, lower respiratory tract, cephalgia, gastrointestinal), and severity (defined as admission and PICU need), both in positive and negative cases. We analyzed outcomes and differences between positive and negative patients.

Results: 536 patients were registered, whom 48.1% were Female. Positivity rate was 20.9%, with a greater proportion in urban than in rural area (25.9% vs 18.6%, p=0.038). The median age in months was higher in positive cases (94.4 vs 62.2, p<0.001).

Within the main symptoms, only cephalgia had a positive association with SARS-CoV-2 infection (56% vs 44%, p<0.001). On the other hand, upper respiratory tract symptoms had a negative association with obtaining a positive test (47.2% vs 52.9%, p<0.001), as well as high fever (16.3% vs 83.7%, p<0.01). No ethnical differences were founded. SARS-CoV-2 cases had less severity, with a lower admission rate (6.2% vs 13.2%, p=0.026) and no PICU cases.

Conclusions/Learning Points: In our sample, the results are consistent with the main network research in Catalonia (COPEDICAT).

We conclude that more studies of paediatric COVID19 characterization are needed in order to develop specific protocols that will help to improve the current management and children's quality of life.

EP510 / #1198

Topic: AS13. COVID 19 and MIS-C

SEVERE PAEDIATRIC COVID-19 PNEUMONITIS TREATED WITH REMDESIVIR AND NITAZOXANIDE

E-Posters

E-POSTER VIEWING

Nuria Sanchez Clemente¹, Charlene Rodrigues², Juanita Pang³, Judith Breuer³, Paul Aurora⁴

¹London School of Hygiene and Tropical Medicine, Infectious Disease Epidemiology, London, United Kingdom, ²University of Oxford, Department Of Zoology, Oxford, United Kingdom, ³UCL Great Ormond Street Institute for Child Health, Infection, Immunity And Inflammation Research Department, London, United Kingdom, ⁴Great Ormond Street Hospital for Children, Paediatric Respiratory Medicine, London, United Kingdom

Title of Case: Severe Paediatric COVID-19 pneumonitis treated with remdesivir and nitazoxanide

Background: Paediatric severe acute respiratory syndrome coronavirus 2 (SARS-CoV-2) infection rarely results in severe disease. We describe a case of a five year old girl with critical SARS-CoV-2 infection requiring Extra Corporeal Membrane Oxygenation (ECMO) treated with remdesivir and nitazoxanide who made a full recovery.

Case Presentation Summary: The girl was born at term in the UK to consanguineous parents. She had recurrent severe respiratory viral illnesses from 5 months of age which resulted in several admissions to paediatric intensive care unit (PICU). In December 2020, she presented with respiratory symptoms and a positive SARS-CoV-2 polymerase chain reaction (PCR). She developed progressive respiratory failure, leading to intubation and rapidly required ECMO. She was started on a course of remdesivir and pulsed methylprednisolone. Remdesivir was discontinued after four doses, due to increasingly deranged liver function tests. On day 15, while still on ECMO, a second course of remdesivir was commenced together with adjunctive nitazoxanide. Dual therapy was continued for ten days with evidence of viral load suppression from Ct 25 to Ct 36 occurring within 36 hours. To investigate the response to treatment, we obtained full length SARS-CoV-2 genome sequences from six positive bronchoalveolar lavage samples and four nasopharyngeal aspirate samples. All samples were identified as lineage B.1.1.7 using Local Lineage and Monophyly Assessment (LLAMA). In a phylogenetic tree with other global and local SARS-CoV-2 samples, all ten consensus sequences from this patient clustered together, indicating no evidence of multiple haplotypes or mixed infection. There were no resistance mutations identified.

Learning Points/Discussion: The successful suppression of viral load and clinical improvement raises the possibility that combining remdesivir with a second agent may improve outcomes in severe paediatric SARS-CoV-2

pneumonitis.

Figure 1 (A) Cycle threshold value trajectories with indications of treatments received. Orange bar = nitazoxanide treatment received; blue bar = remdesivir treatment received. **(B)** Chest x-ray appearances on admission (02/01), and on ECMO (03/01, 04/01, 08/01, 12/01) showing gradual improvement.

(A)

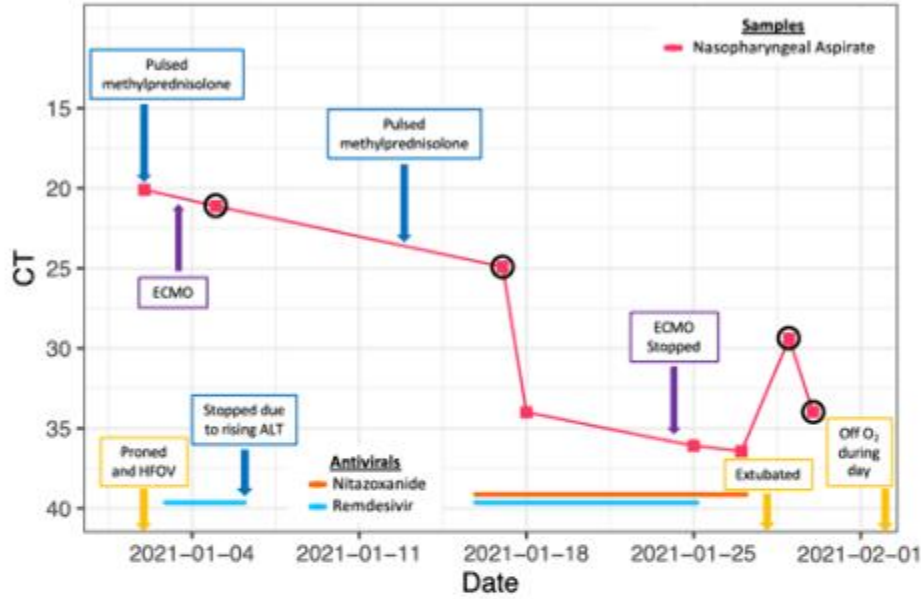

(B)

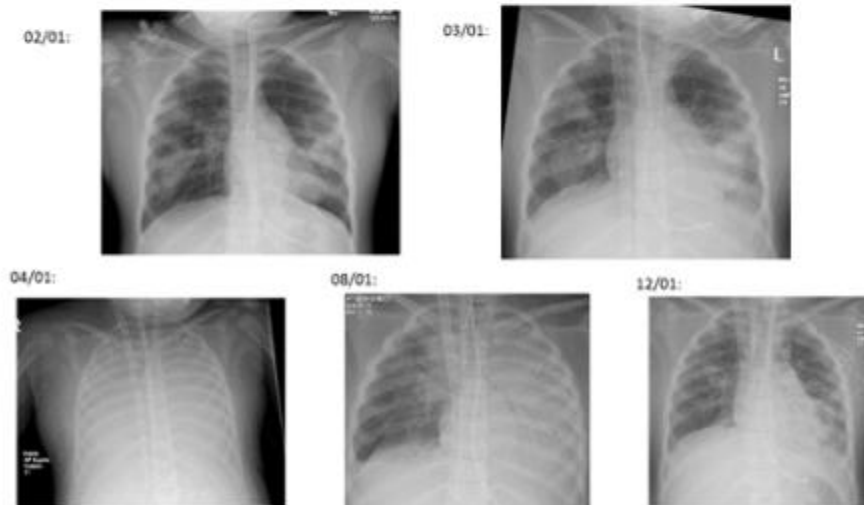

EP511 / #1353

Topic: AS13. COVID 19 and MIS-C

LINKS2HEALTHIERBUBS: A DATA LINKAGE STUDY ESTIMATING THE EFFECTIVENESS OF MATERNAL PERTUSSIS VACCINATION AMONG AUSTRALIAN INFANTS

E-Posters

E-POSTER VIEWING

Annette Regan^{1,2}, Hannah Moore³, Michael Binks⁴, Lisa Mchugh⁵, Christophery Blyth⁶, Gavin Pereira², Karin Lust⁷, Mohinder Sarna², Ross Andrews⁸, Damien Foo², Paul Effler⁹, Stephen Lambert^{8,10}, Paul Van Buynder¹¹

¹University of San Francisco, School Of Nursing And Health Professions, San Francisco, United States of America, ²Curtin University, School Of Population And Public Health, Bentley, Australia, ³University of Western Australia, Telethon Kids Institute, Nedlands, Australia, ⁴Menzies School of Health Research, Child Health Division, Darwin, Australia, ⁵University of Queensland, School Of Public Health, Brisbane, Australia, ⁶University of Western Australia, Division Of Pediatrics, Nedlands, Australia, ⁷Royal Brisbane Hospital, Department Of Internal Medicine And Aged Care & Womens And Newborn Services, Brisbane, Australia, ⁸Queensland Department of Health, Queensland Department Of Health, Brisbane, Australia, ⁹Department of Health Western Australia, Communicable Disease Control Directorate, Perth, Australia, ¹⁰National Centre for Immunisation Research and Surveillance, National Centre For Immunisation Research And Surveillance, Westmead, Australia, ¹¹Australian Immunisation Coalition, Australian Immunisation Coalition, Brisbane, Australia

Backgrounds: Maternal immunisation is a recommended strategy for protecting young infants from pertussis-related morbidity and mortality. Between 2014-2015, Australian jurisdictions introduced and funded diphtheria-tetanus-acellular pertussis (dTpa) vaccination programs for women from 28 weeks of pregnancy. We aimed to estimate the effectiveness of maternal pertussis immunisation overall and by gestational age at dTpa vaccination.

Methods: We established a population-based cohort of mother-infant pairs between 2014 and 2017 using probabilistic record linkage of three Australian jurisdictional data collections: Western Australia, Northern Territory and Queensland. Jurisdictional immunisation records were used to define maternal vaccination status and notification records were used to identify pertussis infections in infants from 0-6 months of age. Risk ratios (RR) were estimated using log-binomial regression weighted by inverse probability of vaccination. We estimated vaccine effectiveness (VE) as $1-RR$ overall and by gestational age at vaccination.

Results: Among 294,342 mother-infant pairs, 51.5% received dTpa vaccination during pregnancy, predominantly between 28–31 weeks of pregnancy. VE was 74% (95% CI 54%, 86%) among <2 month olds, 64% (95% CI 31%, 81%) in 3–4 month olds, and 60% (95% CI 28%, 77%) in 5–6 month olds. We observed similar estimates of VE for pregnancies immunized prior to 28 weeks (VE: 72% 95% CI 37%, 88%) and pregnancies immunized at 32 weeks or later (VE 68%; 95% CI 40%, 83%).

Conclusions/Learning Points: Results support current policies recommending dTpa vaccination during pregnancy and indicate vaccination is effective when administered prior to 28 weeks of gestation. Pertussis immunisation during pregnancy could prevent a majority of pertussis cases in infants <6 months of age.

EP513 / #1197

Topic: AS13. COVID 19 and MIS-C

PULMONARY FUNCTION AND LONG-TERM COMPLAINTS IN CHILDREN AND ADOLESCENTS AFTER COVID-19

E-Posters

E-POSTER VIEWING

Anne Schlegtendal¹, Leona Knoke¹, Lynn Eitner², Christoph Maier¹, Thomas Lücke², Folke Brinkmann¹
¹University Children's Hospital, Paediatric Pneumology, Bochum, Germany, ²University Children's Hospital, Neuropaediatrics, Bochum, Germany

Backgrounds: Persistent respiratory symptoms after COVID-19 in adults are frequent and pulmonary function can show long-term impairment. Only preliminary evidence is available on persistent respiratory sequelae in children. Our objective was to examine the long-term effects of both symptomatic and asymptomatic SARS-CoV-2 infection on pulmonary function in a single-center, controlled, prospective study.

Methods: Participants with serological or PCR-based evidence of SARS-CoV-2 infection were recruited from a population-based study on seroconversion rates. Multiple-breath washout, bodyplethysmography, and diffusion capacity testing were performed. Subjects were interviewed about symptoms during acute phase of infection and long-lasting complaints. Cases were compared to SARS-CoV-2 seronegative controls from the same population-based study with and without history of previous respiratory infection within six months prior to assessment.

Results: 73 seropositive children and adolescents (5–18 years) were recruited after an average of 2.6 months (range 0.4–6.0) after SARS-CoV-2 infection. Four (5.5%) had to be hospitalized during acute infection. Of the 19 patients (27.1%) who complained about persistent or newly emerged symptoms since SARS-CoV-2, eight (11.4%) reported respiratory symptoms. Comparing patients to 45 seronegative controls (14 (31,1%) with a history of previous other infection), no significant differences were detected in frequency of abnormal pulmonary function (SARS-CoV-2: 12, 16.4%; controls: 12, 27.7%; OR 0.54, 95% CI 0.22–1.34). Two patients with persistent respiratory symptoms showed abnormal pulmonary function. Multivariate analysis revealed reduced FVC ($p=0.045$) in patients with severe infection regardless of SARS-CoV-2 infection.

Conclusions/Learning Points: Pulmonary function including diffusion capacity and multiple-breath washout is rarely impaired in children and adolescents after SARS-CoV-2 infection, except of those with severe infection and did not differ between COVID-19 and other previous infections. The discrepancy between persistent respiratory symptoms and normal pulmonary function suggests a different underlying pathology like dysfunctional breathing.

EP514 / #1455

Topic: AS13. COVID 19 and MIS-C

COVID-19 PANDEMIC IN A PAEDIATRIC TERTIARY EMERGENCY SERVICE (ES)

E-Posters

E-POSTER VIEWING

Mariana Sebastião^{1,2}, Ana Rita Fradique¹, Cátia Martins^{1,2}, Lia Gata^{1,3}, Fernanda Rodrigues^{1,2,4}
¹Hospital Pediátrico Coimbra - Centro Hospitalar e Universitário de Coimbra, Emergency Service, Coimbra, Portugal, ²Hospital Pediátrico, Centro Hospitalar e Universitário de Coimbra, Infectious Diseases Unit And Emergency Service, Coimbra, Portugal, ³Hospital Pediátrico, Centro Hospitalar e Universitário de Coimbra, Portugal, Infectious Diseases Unit And Emergency Service, Coimbra, Portugal, ⁴University of Coimbra, Faculty Of Medicine, Coimbra, Portugal

Backgrounds: COVID-19 was first identified in Portugal in March 2020, with the government declaring a State of Emergency shortly after, that lasted until May 2020. Later in the year, a new wave led to a new State of Emergency, lasting until May 2021. The Wuhan strain dominated until the end of 2020 followed by Alpha, then Delta and since December 2021 Omicron variants. The pandemic brought unexpected effects on healthcare services access and usage. The aim of this study is to analyse the impact in a paediatric ES.

Methods: Coimbra Children's Hospital, located in the central region of Portugal, provides tertiary care for the entire central region of the country and is the referral centre for COVID-19 and PIMS-TS admissions. We analysed the ES episodes between March 2018 and December 2021, the number of SARS-CoV-2 positive tests and the number of PIMS-TS cases observed over this period.

Results: ES admissions, SARS-CoV-2 positive tests and PIMS-TS cases are shown in the figure. In the first year of the pandemic there was an historic reduction in the ES episodes that rose back up to pre-pandemic numbers in June 2021, followed by a further fall during the Omicron wave that is taking place. There were two peaks of SARS-CoV-2 detection during the Alpha and Omicron waves. The majority of PIMS-TS cases followed the peak of the Alpha wave.

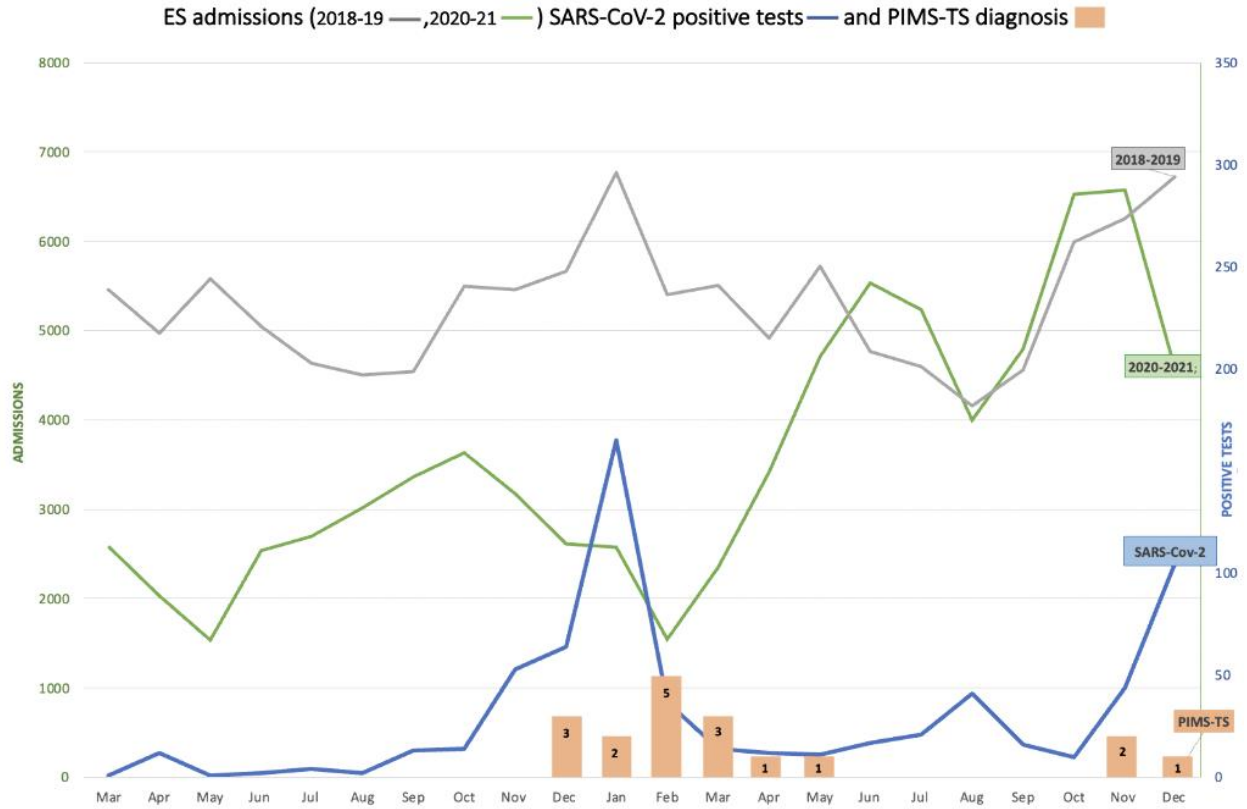

Conclusions/Learning Points: The months with the highest rates of SARS-CoV-2 detection had the lowest presentation rates at the ES, with an important reduction as compared to the same months in previous years. The highest number of PIMS-TS cases occurred during the period of high community transmission in the Alpha wave.

EP515 / #923

Topic: AS13. COVID 19 and MIS-C

CHANGE IN RESPIRATORY VIRAL PATHOGEN DETECTION IN UK CHILDREN BEFORE AND DURING THE COVID-19 PANDEMIC IN THE PERFORM AND DIAMONDS STUDIES

E-Posters

E-POSTER VIEWING

Priyen Shah¹, Marie Voice¹, Jethro Herberg², Colin Fink^{1,2}

¹Imperial College London, Paediatric Infectious Diseases, London, United Kingdom, ²Imperial College London, Department Of Infectious Disease, London, United Kingdom

Backgrounds: The public health response to Covid-19 led to reduced societal mixing. We examined how public health actions that were designed to reduce SARS-CoV-2 transmission impacted on the detection of other respiratory pathogens.

Methods: We compared detection of 20 respiratory viruses before and after the emergence of Covid19, in children presenting to emergency departments in the U.K. with fever or a suspected infective or inflammatory disease recruited to the PERFORM (January 2017-August 2018) and DIAMONDS (January 2020-August 2021) studies. Throat swabs were analysed using the NxTAG™ Respiratory Pathogen Panel (RPP) assay (Luminex® Corporation).

Results: The detection of one or more viruses in throat swabs fell from 328 of 754 (43.5%) before January 2020 to 120 of 558 (21.5%) after ($p=0.007$). Of the 120 patients with positive viral detections after January 2020, SARS-CoV-2 was detected in 24 (20%). There were decreased detections of most viruses including influenza A (2.9% to <1%, $p=0.005$), influenza B (2.5% to <1%, $p=0.014$), RSV (5.8% to <1%, $p=0.008$), combined parainfluenza1-4 (5% to 2.6%, $p=0.01$), human metapneumovirus (2.4% to <1%, $p=0.002$) and enterovirus (3.1% to <1%, $p=0.005$). Rhinovirus (19% to 15%) and bocavirus (5.3% to 5.1%) showed no significant change in frequency of positive detections. Detection of adenovirus increased (4.1% to 7.1%, $p=0.019$).

Conclusions/Learning Points: Whilst the contribution of secular trends and inter-seasonal variation cannot be excluded, the public health actions to reduce respiratory viral transmission led to an uneven effect across different viruses. For 9 viruses, there was a decrease to <1% detection, though not for rhinovirus, bocavirus or adenovirus. Understanding the basis for these differences may help control future viral outbreaks.

EP516 / #1044

Topic: AS13. COVID 19 and MIS-C

GASTROENTEROLOGICAL SYMPTOMS IN A NEW CORONAVIRUS INFECTION IN CHILDREN AND THE CYTOKINE STATUS

E-Posters

E-POSTER VIEWING

Maria Shakmaeva¹, Anna Polunina², Dmitriy Ivanov², Vladimir Timchenko³, Svetlana Bannova³, Olga Gurina², Alexander Blinov², Olga Varlamova², Lubov Pochinyaeva⁴, Kseniya Klikunova², Sergey Lapin⁵, Valeria Novikova²

¹Saint-Petersburg State Pediatric Medical University, Department Of Infectious Diseases In Children Named After Professor M.g. Danilevich, Saint-Petersburg, Russian Federation, ²St. Petersburg State Pediatric Medical University, Department Of Propaedeutics Of Children's Diseases, Saint-Petersburg, Russian Federation, ³St. Petersburg State Pediatric Medical University, Department Of Infectious Diseases In Children Named After Professor M.g. Danilevich, Saint-Petersburg, Russian Federation, ⁴Children's City Clinical Hospital No. 5 named after N.F. Filatov, Children's City Clinical Hospital No. 5 Named After N.f. Filatov, Saint-Petersburg, Russian Federation, ⁵Pavlov First St. Petersburg State Medical University, Pavlov First St. Petersburg State Medical University, Saint-Petersburg, Russian Federation

Backgrounds: It is known that diarrhea in Covid-19 infection occurs with a frequency of 7.2-8.2%, vomiting 7.1-8.5%, abdominal pain 2.0-3.4%. The relationship between their frequency and the age of children, the severity of the disease and the level of pro-inflammatory cytokines has not been studied.

Methods: 161 children aged 3 years to 15 years with Covid-19 were examined. Gastroenterological symptoms were assessed, the level of interleukins IL6, IL18, IL 10 and procalcitonin in the blood serum was determined.

Results: The frequency of abdominal pain in the examined children was 0.7%, nausea 2.4%, vomiting 3.9%, diarrhea 4.6%. No relationship was found between the frequency of gastrointestinal symptoms and the severity of Covid-19 infection and the age of children. The level of IL6 in children with mild form was lower (0,12 mcg/ml (0,01-0,58) than in moderate (0,47 mcg/ml (0,01 - 2,19), p=0,032). The level of IL6 in children with vomiting (2.45 mcg/ml (2.22–4.88 mcg/ml) was higher than in its absence (0.82 mcg/ml (0.23-2.68 mcg/ml) p= 0.027. The level of IL18 in children with mild form was lower (227.05 pg/ml (149.65-295.81) than in moderate (329.26 pg/ml (264.87-504.23), p=0.002. The level of procalcitonin in children with vomiting (0.097 ng / ml (0.052-0.461) was higher than in the absence of it (0.034 ng / ml (0.022-0.062) p = 0.008.

Conclusions/Learning Points: 1. The frequency of gastrointestinal symptoms in children with Covid-19 does not exceed 5% and does not depend on the age of patients and the severity of the disease. 2. The production of cytokines IL6 and IL18 increases with the severity of the disease. 3. During vomiting, the level of pro-inflammatory cytokines IL-6 and procalcitonin is higher, which indicates the role of a systemic inflammatory response.

EP517 / #735

Topic: AS13. COVID 19 and MIS-C

CLINICAL AND EPIDEMIOLOGICAL CHARACTERISTICS OF MULTISYSTEM INFLAMMATORY SYNDROME IN CHILDREN IN UKRAINE: A CASE SERIES

E-Posters

E-POSTER VIEWING

Olha Shvaratska¹, Tina Bordiy¹, Svitlana Alifanova¹, Yaroslav Vilensky¹, Valentin Ulianov²

¹Dnipro State Medical University, Department Of Pediatrics 3 And Neonatology, Dnipro, Ukraine, ²Dnipro City Children Clinical Hospital 6, Department Of Infectious Diseases, Dnipro, Ukraine

Title of Case: CLINICAL AND EPIDEMIOLOGICAL CHARACTERISTICS OF MIS-C IN UKRAINE

Background: Multisystem inflammatory syndrome in children (MIS-C) is a rare but severe and potentially fatal complication of SARS-CoV-2 infection that requires timely management. However, it could be challenging to diagnose MIS-C since the manifestations can vary widely. Moreover, the relation to the preceding SARS-CoV-2 infection is not always clear especially in countries with limited testing and numerous underdiagnosed COVID-19 cases.

Case Presentation Summary: We performed an assessment of all MIS-C cases at the level of the major city secondary level healthcare setting, Dnipro City Children Hospital 6 (Ukraine), for the period from April 2020 to December 2021. Ten children aged 3 to 14 years were diagnosed with MIS-C in total, including five cases during the latest epidemic surge with SARS-CoV-2 variant B.1.617.2 predominance. Male to female ratio was 9:1. One patient had juvenile idiopathic arthritis, one had chronic kidney disease, and eight were previously healthy. The prevalence of MIS-C symptoms was registered as: gastrointestinal disorders (100% of cases), skin rash (90%), non-exudative conjunctivitis (80%), hand and feet edema (60%), hypotension (40%), pulmonary and cardiac involvement (20% each). All children presented with an elevated serum C-reactive protein, in most cases elevated D-dimer, procalcitonin and ferritin were also found. Specific serum immunoglobulins M detection confirmed the association with COVID-19 since SARS-CoV-2 PCR tests were mostly negative. In younger children MIS-C had more favorable course compared to adolescents. All patients recovered without any serious long-term sequelae.

Learning Points/Discussion: Therefore, in lower middle-income countries with a limited access to SARS-CoV-2 testing it is essential to consider MIS-C even in absence of confirmed SARS-CoV-2 infection, as well as to apply adequate management and follow-up to ensure a better care for patients.

EP518 / #742

Topic: AS13. COVID 19 and MIS-C

ACUTE FEEDING DISORDERS IN INFANTS AFTER ASYMPTOMATIC SARS-COV-2 INFECTION: A CASE SERIES

E-Posters

E-POSTER VIEWING

Olha Shvaratska¹, Victor Mavrutenkov², Tatiana Mavrutenkova³

¹Dnipro State Medical University, Department Of Pediatrics 3 And Neonatology, Dnipro, Ukraine, ²Dnipro State Medical University, Department Of Infectious Diseases, Dnipro, Ukraine, ³Diagnostic Center of Medical Academy, Department Of Pcr Diagnostics, Dnipro, Ukraine

Title of Case: ACUTE FEEDING DISORDERS IN INFANTS AFTER ASYMPTOMATIC SARS-COV-2 INFECTION

Background: Considering that vaccination against COVID-19 for infants is not expected to be implemented soon, we may anticipate an increase in proportion of cases in the youngest age group. Thus, presentation of COVID-19 in young children is an issue of a substantial clinical significance.

Case Presentation Summary: We observed two cases of food refusal in previously healthy first year infants (5-month-old breastfed male and 12-month-old female on formula feeding) several weeks after a confirmed symptomatic SARS-CoV-2 infection in caregivers. Parents reported no or minor symptoms in their children during or immediately after COVID-19 in the family members; none of the infants had fever, cough, or upper respiratory manifestations. Both infants actively communicated hunger and attempted to start eating but repeatedly refused feeding. Examination revealed no underlying medical conditions including infections and oral lesions. Current body weight in both infants corresponded to age, however, the weight-to-age curve has flattened recently. Both infants seemed hydrated, however, some reduction in stool frequency was reported. We assume that feeding refusal in both cases could be explained with olfactory and taste disorders due to asymptomatic SARS-CoV-2 infection. Feeding correction was prescribed along with daily control of body weight. Shortly both families stopped attending the follow-up visits, and we found no related hospital admissions in the registry in the subsequent month. Thus, we cannot be completely confident about the full restoration of taste and actual recovery time.

Learning Points/Discussion: Thus, clinical presentation and post-acute sequela of COVID-19 in infants could be limited to taste disorders only, which are difficult to be detected but could result in food refusal. Currently there is a paucity of taste rehabilitation methods, consequently, further studies are warranted.

EP519 / #610

Topic: AS13. COVID 19 and MIS-C

SEVERE ACUTE RESPIRATORY SYNDROME-RELATED CORONAVIRUS 2 PREVALENCE IN CHILDREN AND YOUNG ADULTS IN BRITISH COLUMBIA (THE SPRING STUDY): AN OBSERVATIONAL STUDY

E-Posters

E-POSTER VIEWING

Sarah Silverberg¹, Hennady Shulha¹, Bahaa Abu-Raya¹, Sofia Bartlett², Julie Bettinger¹, Adriana Cabrera¹, Daniel Coombs³, Soern Gantt^{1,4}, Vivek Gill¹, David Goldfarb⁵, Helen He¹, Agatha Jassem², Mel Krajden², Muhammad Morshed², Laura Sauve¹, Inna Sekirov², Danuta Skowronski⁶, Manish Sadarangani¹

¹BC Children's Hospital, Vaccine Evaluation Center, Vancouver, Canada, ²BC Centre for Disease Control, Public Health Laboratory, Vancouver, Canada, ³University of British Columbia, Mathematics, Vancouver, Canada, ⁴CHU Sainte-Justine, Centre De Recherche Du Chu Sainte-justine, Montreal, Canada, ⁵BC Children's Hospital, Pathology And Laboratory Medicine, Vancouver, Canada, ⁶BC Centre for Disease Control, Influenza & Emerging Respiratory Pathogens, Vancouver, Canada

Backgrounds: Pediatric COVID-19 cases are generally considered less severe than in adults with a varying proportion considered asymptomatic. These differences in clinical presentation complicate estimates of disease burden by age based solely on reported surveillance data. We aimed to estimate age- and sex-specific prevalence of SARS-CoV-2 infection in children and youth based on presence of serum anti-SARS-CoV-2 IgG antibodies and define symptomatic and asymptomatic infection rates.

Methods: We conducted a prospective, observational study of children and youth <25 years of age in British Columbia, Canada across two phases, December 2020-March 2021 and since June 2021 (ongoing, data presented to October 2021). Participants completed an electronic survey and self-collected finger-stick dried blood spot samples. Phase 2 participants are unvaccinated children less than 10yo.

Results: There were 2129 participants included in Phase 1 and 360 included in Phase 2 analyses. Of the tested samples, 4.4% (n=95) were seropositive in Phase 1, while 5.3% (n=19) were seropositive amongst 0-9yo unvaccinated children in Phase 2. Amongst all ages in Phase 1, youth ages 20-24 had the highest seroprevalence of 7.22% (95% CI: 5.21, 9.92). There was no significant difference in seroprevalence between boys and girls. Participants who identified as South Asian, West Asian, and Filipino had a higher seroprevalence of 10.89% (95% CI: 6.19, 18.46), 25% (95% CI: 8.89, 53.23) and 14.63 (95% CI: 6.88, 28.44) respectively.

Conclusions/Learning Points: We found low rates of COVID-19 seroprevalence amongst children and youth before the introduction of pediatric COVID-19 vaccines, with higher rates amongst 20-24yo youth. Seroprevalence in Phase 1 was more than double the provincially reported case rates for the same age group collected and time frame. Findings suggest a substantial under-detection and/or under-reporting of SARS-CoV-2 cases amongst children and youth.

EP520 / #1937

Topic: AS13. COVID 19 and MIS-C

SEVERE PANCYTOPENIA AND REBOUND HYPER THROMBOCYTOSIS

E-Posters

E-POSTER VIEWING

Tracy Evans Gilbert¹, Corrine Sin Quee², Chelsea Brown², Michelle Reece-Mills³

¹University of the West Indies, Child And Adolescent Health, Kingston, Jamaica, ²University of The West Indies, School Of Clinical Medicine And Research, Nassau, Bahamas, ³University of The West Indies, Child And Adolescent Health, Kingston, Jamaica

Title of Case: SEVERE PANCYTOPENIA AND HYPERTHROMBOCYTOSIS FOLLOWING ACUTE INFECTION WITH COVID-19

Background: COVID 19 is known to have a spectrum of hematopoietic events including severe pro-inflammatory states associated with a unique coagulopathy or thrombocytopenia. We describe novel severe pancytopenia with marked rebound thrombocytosis and spontaneous recovery in a previously healthy teenage girl diagnosed with SARS-CoV2 infection.

Case Presentation Summary: A previously healthy athletic 14-year-old girl presented with a syncopal attack. She denied COVID-19 symptoms, bone pain, fatigue, palpitations, bruising, or blood loss. She had a household infectious contact with COVID 19. Examination showed pallor, no petechiae, purpura, lymphadenopathy, organomegaly, or dysmorphic features. She was well-appearing, afebrile, relatively tachycardic (HR 94/min), BP 100/64, with otherwise normal examination. The diagnosis was severe pancytopenia after initial investigations showed: Hemoglobin (Hb) 5.6g/dL, MCV 54fL, white blood cell (WBC) 2.5×10^9 /L-absolute neutrophil count(ANC) 925/ μ l, Platelet 115000/ μ l. Her SARS-CoV-2 RT-PCR was positive, and the peripheral blood smear showed microcytosis, rare large platelets but no blasts; normal- iron studies, ferritin, and LDH and negative-ANA, HIV, HBsAg, and Coombs; EBV titers-suggested past infection. Bone marrow aspiration/biopsy ruled out leukemia and aplastic anemia. She developed hyposmia on day 5. She received a red blood cell transfusion and was discharged on day 9 with a Hb 7.8g/dL, WBC 4.01×10^9 /L -ANC 1520, Platelet 39000/ μ l. Two weeks later, her platelet increased to 1071000/ μ l. Seven weeks later, all results were normal.

Learning Points/Discussion: Severe pancytopenia and rebound hyper-thrombocytosis can occur with COVID-19. Similar to other acute infections, cytokines, particularly interleukin-6 or thrombopoietin, can be implicated. This patient did not present with an acute inflammatory process; however, for patients with platelet counts more than 1,000,000 per mL, prophylactic aspirin for the rare development of stroke or thrombosis should be considered considering the disease spectrum with COVID 19

EP521 / #1485

Topic: AS13. COVID 19 and MIS-C

SEVERE BACTERIAL INFECTION INITIALLY MISDIAGNOSED AS MIS-C: CAUTION NEEDED

E-Posters

E-POSTER VIEWING

Anna Stanzelova¹, Agathe Debray¹, Slimane Allali¹, Zahra Belhadjer², Muhamed-Kheir Taha³, Jérémie F Cohen¹, Julie Toubiana¹

¹Hôpital Necker Enfants Malades, Assistance Publique – Hôpitaux de Paris (AP-HP), Université de Paris, Pédiatrie Générale Et Maladies Infectieuses, Paris, France, ²Hôpital Necker Enfants Malades, Assistance Publique – Hôpitaux de Paris (AP-HP), Université de Paris, M3c, Paris, France, ³Institut Pasteur, Invasive Bacterial Infections, Paris, France

Title of Case: Severe bacterial infection initially misdiagnosed as MIS-C: caution needed

Background: Multisystem Inflammatory Syndrome in Children (MIS-C) is a well-recognized hyperinflammatory complication of novel coronavirus disease 2019 (COVID-19) in children.

Case Presentation Summary: We present the case of a 6-year-old boy with fever, productive cough, odynophagia, diffuse myalgia, and abdominal pain in October 2020, at the height of the second wave of the COVID 19 pandemic in France. On clinical exam, he was tachycardic. Initial work up showed high inflammatory markers (C-reactive-protein (CRP) 324 mg/L, procalcitonin 23 ng/mL) and biological signs of myocardial injury (N-Terminal pro-BNP (NT-proBNP) 1760 ng/L (N<300 ng/L), high-sensitivity troponin I 54 ng/L (N<26 ng/L). The electrocardiogram showed sinus tachycardia with diffuse ST elevation with no other abnormalities. Transthoracic echocardiogram revealed left ventricular dysfunction, with decreased left ventricular ejection fraction (47%) and septo-apical hypokinesia. He was treated with intravenous corticosteroid therapy (methylprednisolone 0.8 mg/kg/12h) and intravenous immunoglobulins (IVIg 1 g/kg/day for two days). Despite this treatment, he remained febrile. His blood cultures grew *Neisseria meningitidis* on the second day of admission. He responded well to a treatment by third generation cephalosporins, but his stay was complicated by secondary right elbow meningococcal septic arthritis and polyseritis.

Learning Points/Discussion: While the current pandemic has raised awareness of multisystem inflammatory complications in children and specifically the cardiac involvement post COVID 19 infection, it is important to maintain a wide differential diagnosis in children with febrile myocardial dysfunction, and treat with empiric antibiotics until bacterial infection is ruled out.

EP522 / #1918

Topic: AS13. COVID 19 and MIS-C

COVID19 -EPIDEMIOLOGICAL, CLINICAL AND EVOLUTIVE ASPECTS IN INFANTS, DURING THE 5 PANDEMIC WAVES IN A TERTIARY HOSPITAL FROM ROMANIA

E-Posters

E-POSTER VIEWING

Andreea Florentina Stoenescu^{1,2}, Geta Vancea^{1,2}, Dana Ispas¹, Nicoleta Voicu-Parvu¹, Gabriela Precup¹, Nicoleta Tudor¹, Gabriela Scurtu¹, Andreea Popica¹, Elena Sandu¹, Claudia Chirila¹, Raluca Bontea¹, Octavian Tabacaru¹, Alexandra Vlad¹, Diana Potarniche¹, Mihai Radu¹, Catalin Iacob¹, Dragos Budea¹, Ionela Voda¹, Corneliu Popescu^{1,3}, Emanoil Ceausu^{1,2}, Simin-Aysel Florescu^{1,2}

¹Clinical Hospital of Infectious and Tropical Diseases "Dr. Victor Babeş", Infectious Diseases, Bucharest, Romania, ²Carol Davila University of Medicine and Pharmacy, Infectious Diseases, Bucharest, Romania, ³Carol Davila University of Medicine and Pharmacy, Virology, Bucharest, Romania

Backgrounds: The COVID-19 pandemic has affected all age groups. The aim of the study was to determine the incidence, clinical and biological characteristics and evolution of patients diagnosed with COVID-19.

Methods:: Prospective study on a group of infants admitted to the Clinical Hospital of Infectious and Tropical Diseases „Dr. Victor Babeş ”from Bucharest, during the pandemic between March 2020 - February 2022.

Results: During the evolution of the 5 waves, 288 patients under 1 year of age were hospitalized. Of these, 60.7% were male. The onset of the pandemic has seen a decline in the number of patients under 1 year of age. Subsequently, the following waves were characterized by an increasing incidence of cases in this age group. 71.1% had contact with a family member diagnosed with COVID19. The clinical picture was dominated by fever, present in 83.3% of all cases, especially in wave 5 when it affected 95% of hospitalized patients. Digestive manifestations were present in 39.2% of all patients, especially in the second and fifth wave. Respiratory symptoms occurred in 32.9% of cases in the form of cough, while 17.3% of patients had rhinorrhea. During the last wave, most patients were diagnosed with laryngitis. Hematologically, leukopenia was present in 14.5% of cases and lymphopenia in 13.5%. Biochemically, hepatocytolysis was the most common in 59.3% of patients. Patients had a favorable evolution under treatment, 1 patient required transfer to the pediatric intensive care unit and oro-tracheal intubation.

Conclusions/Learning Points: The incidence of SARS-COV2 infection in infants increased progressively during the pandemic. The clinical picture was dominated by fever and digestive manifestations, with a favorable evolution in most cases.

EP523 / #1534

Topic: AS13. COVID 19 and MIS-C

SARS-COV-2 NEUTRALIZING ANTIBODIES IN VACCINATED MOTHERS AND IN THEIR CHILDREN

E-Posters

E-POSTER VIEWING

Marta Stracuzzi¹, Anna Sala¹, Gabriella Guida¹, Claudia Vanetti², Claudio Fenizia^{2,3}, Daria Trabattoni³, Mario Clerici⁴, Gian Vincenzo Zuccotti⁵, Valeria Savasi⁶, Vania Giacometti¹

¹Università degli Studi di Milano, Pediatric Infectious Disease Unit, Luigi Sacco Hospital, Milano, Italy, ²Università degli studi di Milano, Chair Of Immunology - Department Of Pathophysiology And Transplantation, Milan, Italy, ³Università degli studi di Milano, Department Of Biomedical And Clinical Sciences "Luigi Sacco", Milan, Italy, ⁴Università degli studi di Milano and IRCCS Fondazione Don Carlo Gnocchi, Department Of Pathophysiology And Transplantation, Milan, Italy, ⁵Università degli studi di Milano, Department Of Pediatrics, V. Buzzi Children's Hospital, Department Of Biomedical And Clinical Sciences "I. Sacco" And Pediatric Clinical Research Center "Romeo Ed Enrica Invernizzi", Milan, Italy, ⁶Università degli studi di Milano, Department Of Obstetrics, Milan, Italy

Backgrounds: Promising data on protective immunological response induced by vaccines against SARS-CoV-2 in pregnant and lactating women have already been obtained. We aimed to study in depth the possibility for the mothers to transfer neutralizing antibodies, induced by the COVID-19 vaccines, to the offsprings both trans placentally and during breastfeeding.

Methods: Eight SARS-CoV-2 vaccinated mothers during pregnancy or breastfeeding and their children were enrolled in the study. Blood samples were collected before SARS-CoV-2 vaccine (ChAdOx1-S and BNT162b2 Vaccines, MO), at delivery (B) and after 3 months from it (T3). Subjects were assigned to 3 study groups: 1) full vaccinated pre-partum (n = 2); 2) partial vaccinated pre partum (n = 4), and 3) fully vaccinated during breastfeeding (n = 2). None of the enrolled subjects were SARS-CoV-2 infected during sampling. Plasma neutralizing antibody (Nab) assay was performed.

Results: We compared the different groups at each time points (Table 1). In group 1, Nabs in the neonates were detected independently from the level of protection in the mother and the time from the second dose. However, after 3 months from delivery, Nabs waned in both mother and newborn. In group 2, single dose vaccine was not sufficient to elicit Nabs in the mother neither in the newborn. In group 3, we found Nabs in mothers, but not in their children.

Conclusions/Learning Points: A complete administration of COVID-19 vaccine can elicit a maternal humoral response that effectively transfers to the fetus and neonates. A single dose is not sufficient to confer antibody protection to the newborns. Our preliminary data suggest that Nab activity decrease rapidly in newborn born from fully SARS-CoV-2 vaccinated women, independently from the time of vaccine administration.

EP524 / #1527

Topic: AS13. COVID 19 and MIS-C

PERIPHERAL MONOCYTES IN CHILDREN WITH MILD TO MODERATE COVID-19 INFECTION

E-Posters

E-POSTER VIEWING

Garyfallia Syridou, Artemis Mavridi, Danai Ktena, Vassiliki Papaevangelou
National and Kapodistrian University of Athens, Third Department Of Pediatrics, Attikon University
Hospital, Athens, Greece

Backgrounds: Severe COVID-19 is characterized by lymphopenia as a prominent biomarker in adults, while laboratory findings in children with COVID-19 vary between studies. Whether peripheral monocytes have a distinctive pattern in hospitalized versus non-hospitalized COVID-19 paediatric patients is not yet defined.

Methods: Children 0-16 years old with mild to moderate SARS-CoV2 infection, either inpatients or outpatients, diagnosed in our hospital between February 2020 and December 2021, with a complete blood count (CBC) performed at initial evaluation, were included in our study. Demographic characteristics, symptoms and laboratory findings were recorded. CBC findings between hospitalized and non-hospitalized COVID-19 patients were compared.

Results: Sixty-two children (median age=2.2 years, 2:3 girls:boys) with confirmed SARS-CoV2 infection and CBC performed at first hospital evaluation were recorded, of which 47 (76%) were hospitalized. Among all COVID-19 patients, 25.8% had leucopenia, 14.5% neutropenia, 29% lymphopenia, while 24.1% had absolute and 38.7% relative monocytosis. However, no statistically significant association was found between hospitalization and absolute leucocyte counts or lymphocyte-to-monocyte ratio. Interestingly, when comparing hospitalized and non-hospitalized COVID-19 cases a statistically significantly higher monocyte percentage was found in the latter group (11% vs 16%, p-value=0.01).

Conclusions/Learning Points: Peripheral monocytes seem to be higher in COVID-19 paediatric outpatients with mild symptoms when compared to hospitalized children. Peripheral monocytes are fundamental for the control of viral infections and quantity along with quality changes seem to be associated with COVID-19 disease severity.

EP525 / #467

Topic: AS13. COVID 19 and MIS-C

A CAUTIONARY TALE ON THE ADVERSE EFFECTS OF HIGH-DOSE STEROID USE IN CHILDREN WITH PIMS-TS

E-Posters

E-POSTER VIEWING

Grace Tan¹, Alasdair Bamford², Emma Borrow³, Anna Rybak⁴, Orlagh MCGarrity⁵, Karlie Grant², Delane Shingadia², Sara Farah²

¹Lewisham and Greenwich NHS Trust, Medicine, London, United Kingdom, ²Great Ormond Street Hospital for Children NHS Foundation Trust, Paediatric Infectious Diseases, London, United Kingdom, ³Great Ormond Street Hospital for Children NHS Foundation Trust, Paediatric Intensive Care, London, United Kingdom, ⁴Great Ormond Street Hospital for Children NHS Foundation Trust, Paediatric Gastroenterology, London, United Kingdom, ⁵Great Ormond Street Hospital for Children NHS Foundation Trust, Pharmacy, London, United Kingdom

Title of Case: Upper Gastrointestinal Bleed in a patient with PIMS-TS

Background: COVID-19 has led to the emergence of Paediatric Inflammatory Multisystem syndrome temporally associated with SARS-CoV-2 (PIMS-TS), which clinically resembles Kawasaki Disease and Toxic Shock Syndrome. Standard clinical practice is being developed, with intravenous immunoglobulin, high-dose steroids, and supportive measures as the mainstay treatment. Here, we highlight the risk of high-dose steroid therapy in children.

Case Presentation Summary: A 7-year-old, previously healthy, girl presented with a five-day history of fever, abdominal pain, conjunctivitis, maculopapular rash and bilateral periorbital swelling. She was resuscitated with 3 intravenous fluid boluses and started on intravenous immunoglobulin, oral high-dose aspirin, and omeprazole. A positive COVID-19 antibody test later confirmed the diagnosis of PIMS-TS. She became hypotensive despite initial treatment and was transferred to PICU, where she received 10mg/kg intravenous methylprednisolone and 0.5 mcg/kg/min of noradrenaline. She was stepped down to the ward the following day to complete 3 days of methylprednisolone with oral lansoprazole for gastroprotection and prophylactic dalteparin. Upon completion, she experienced intermittent abdominal pain and 3 episodes of melaena. Despite being haemodynamically stable, her haemoglobin dropped from 80mg/dl three days ago to 43mg/dl with a normal clotting profile, necessitating 2 units of blood transfusion. An urgent OGD visualised a 0.5cm ulcer in the gastric antrum covered in fibrin, which was treated with adrenaline. Thereafter, she improved on intravenous esomeprazole and was discharged after three days, with an interval OGD arranged in six weeks.

Learning Points/Discussion: Although stress ulcers, a known complication in PICU patients, remain a differential, clinicians should be vigilant around the side effect of upper gastrointestinal bleed from high-dose steroid therapy in this patient cohort. Future clinical trials for PIMS-TS should include detailed information on adverse outcomes from therapeutic strategies.

EP526 / #982

Topic: AS13. COVID 19 and MIS-C

PREVALENCE AND PROFILE OF ANXIETY AND DEPRESSION AMONG HEALTHCARE WORKERS HANDLING PEDIATRIC PATIENTS IN OSPITAL NG MAKATI DURING COVID-19 PANDEMIC

E-Posters

E-POSTER VIEWING

Ria Camille Tan, Ma. Lucila Perez, Jennifer Lim
Ospital ng Makati, Pediatrics, Makati City, Philippines

Backgrounds: The World Health Organization declared the outbreak of a novel coronavirus a global health emergency on January 31, 2020. The frontline healthcare workers are experiencing heightened levels of stress, anxiety, and even insomnia greatly affecting their mental health aggravating the strain on our healthcare system. Early detection and targeted interventions are needed to enhance psychological wellbeing of healthcare workers and strengthen the healthcare systems' capacity during the pandemic.

Methods: A cross-sectional analytic study. The questionnaires used in the study include a questionnaire on sociodemographic characteristics, Patient Health Questionnaire 9-item (PHQ-9), Generalized Anxiety Disorder 7-item (GAD-7) and Coronavirus Anxiety Scale (CAS) Questionnaire. Ordinal logistic regression analysis was used to determine the relationship between profile of healthcare workers to depressive and anxiety scores. Prevalence rates of high-level stress, anxiety symptoms requiring further evaluation, and depressive symptoms requiring treatment was expressed as proportions with 95% confidence intervals (CI).

Results: The study showed that 27.6% of the respondents screened positive for depression symptoms, 38.3% for anxiety symptoms and 4.3% for dysfunctional COVID-related anxiety. Depression and anxiety were significantly more prevalent in resident physicians than other healthcare workers.

Conclusions/Learning Points: The prevalence of anxiety and depression within healthcare workers handling pediatric patients in Ospital ng Makati during the COVID-19 pandemic are high specifically among nurses and residents. Appropriate psychological screening measures necessitate to improve mental health of healthcare workers is warranted.

EP527 / #1879

Topic: AS13. COVID 19 and MIS-C

THE IMPACT OF COVID -19 PANDEMIC ON YOUNG ATHLETES' MOOD

E-Posters

E-POSTER VIEWING

Stefania Totska¹, Filippina Giannisi², Ilektra Toulia², Stefanos Tsotoulidis³

¹Toumpa Primary Health Centre, Pediatric, Thessaloniki, Greece, ²KASSANDRIA PRIMARY HEALTH CENTRE, Pediatric, KASSANDRIA, Greece, ³KASSANDRIA PRIMARY HEALTH CENTRE, Kassandra Internal Medicine, KASSANDRIA, Greece

Backgrounds: Most epidemiologic studies have suggested that children are just as likely as older age groups to become infected with the coronavirus but are far less likely to develop severe symptoms. However, the Covid-19 pandemic affected children and adolescents' life in various ways, especially during lockdown period. Aim of our study was to investigate the impact of COVID-19 pandemic on young athletes' mood and workout routine.

Methods:: An online survey was conducted by means of a questionnaire which was completed by athletes (aged 12-18) from various cities in Greece, during a strict 3-month lockdown (January 2021- April 2021).

Results: A total of 518 children completed the questionnaire (248 boys) whose mean age was 15.3±1.56 years. Most of them were involved in team sports (84.2%) and the majority of them practiced for more than 3 years (79.6%). Mean training time was 4.83±1.57 hours/week before pandemic which was reduced significantly by 1 hour during lockdown (3.82±2.34 hours/week spent on leisure activities, p=0.001). A quarter of the participants (26%) reported that there was not enough space in their house in order to do any kind of exercise. Most athletes (71.6%) claimed that discontinuation of training had a negative effect on their mood, 73.5% missed their teammates very much and 64% felt very positive about returning back to regular training. However 33.8% did not feel much confident that they will return to previous athletic performance level. There was a small but significant negative correlation between age and the above perceptions.

Conclusions/Learning Points: This study revealed the negative impact of Covid-19 pandemic restrictions on children and adolescents' exercise routine but most importantly on their mood and perception towards regaining previous physical condition.

EP528 / #620

Topic: AS13. COVID 19 and MIS-C

INTENSIVE CARE NEEDS AND OUTCOME OF COVID-19 RELATED MULTISYSTEM INFLAMMATORY SYNDROME IN CHILDREN (MIS-C): A SYSTEMATIC REVIEW

E-Posters

E-POSTER VIEWING

Christos Triantafyllou¹, Maria Gamvrouli²

¹Center for Clinical Epidemiology and Outcomes Research (CLEO), Non-profit Civil Partnership, Athens, Greece, ²National and Kapodistrian University of Athens, Department Of Nursing, Athens, Greece

Backgrounds: Multisystem inflammatory syndrome in children (MIS-C) associated with COVID-19 is a hyperinflammatory syndrome occurring in close temporal association with a severe acute respiratory syndrome coronavirus 2 (SARS-CoV-2) infection in children. The aim of this systematic review was to investigate the intensive care needs and outcome of COVID-19 related MIS-C.

Methods: A systematic search up to September 2021 was conducted in PubMed and IATROTEK-online databases. Moreover, cited references from selected articles were used to find additional studies that were not retrieved in the initial search. Studies eligible for inclusion were those that were published in English and Greek, were case-control or cohort studies of neonates and children aged ≤ 18 years old hospitalized with COVID-19, the full text was available, and their study population included at least 5 cases of children with MIS-C. Study quality was evaluated using the Critical Appraisal Skills Programme Tool (CASP) for cohort and case-control studies.

Results: Of 506 papers identified in the search, 9 were included. Regarding the study design, the majority of the studies were retrospective observational studies and two were prospective observational studies. Four of the studies were conducted in India, two in the USA, and by one in Turkey, Qatar, and Oman. The results of the studies showed that out of the total of 292 patients with MIS-C, only 9 died (3%), while 67.8% (160/236) of the children were hospitalized in Pediatric Intensive Care Unit (PICU).

Conclusions/Learning Points: The results of this systematic review indicate that although the majority of hospitalized children with COVID-19 related MIS-C require careful supportive intensive care, they have a satisfactory outcome. Further studies and longer surveillance of COVID-19 pediatric patients with MIS-C are required to improve diagnostic, treatment, and surveillance criteria.

EP529 / #1885

Topic: AS13. COVID 19 and MIS-C

REMDESIVIR ADMINISTRATION IN CHILDREN WITH SARS-COV-2 INFECTION: A 2-YEAR EXPERIENCE

E-Posters

E-POSTER VIEWING

Maroula Tritzali, Maria Noni, Chrysi-Aikaterini Georgokosta, Enti Ntempis-Zangogiannis, Irene Tzovara, Sotiria Dervili, Anastasia Polytarchou, Vana Spoulou, Athanasios Michos
"Aghia Sophia" Children's Hospital, Division Of Infectious Diseases, First Department Of Pediatrics, Medical School, National And Kapodistrian University Of Athens, Athens, Greece

Backgrounds: Remdesivir was the first antiviral medication to get emergency approval for COVID-19 treatment and it remains one of the few therapeutic options for children with severe COVID-19, despite the mixed results from early clinical studies regarding its efficacy and an incomplete understanding of its safety profile.

Methods:: This is a retrospective study of children 0-16 years old who were diagnosed with SARS-CoV-2 infection and treated with remdesivir, at the largest tertiary pediatric hospital of Athens, Greece, during a 2-year period.

Results: Among 1010 hospitalized children with PCR-documented SARS-CoV-2 infection, 23 (56.5% males) with median age of 9 years (IQR 0.9-14.6) were treated with remdesivir. Fifteen patients (65.2%) had comorbidities, such as obesity (n=5, 33.3%), cardiopulmonary disease (n=3, 20%), neurologic conditions (n=3, 20%), hematologic malignancies (n=2, 13.3%), polycythemia rubra vera (n=1, 6.6%) and moderate prematurity (n=1, 6.6%). The indications for remdesivir treatment were respiratory distress with emerging need for supplemental oxygen (n=16, 69.5%), the presence of medical complexity predisposing for severe disease (n=6, 26%) and extensive pneumonia (n=1, 4.3%). Adverse events were reported in 4 children (17.3%), three boys developed sinus bradycardia and a girl nausea. The majority of children achieved a favorable clinical outcome. However, despite remdesivir treatment, 6 patients (26%) required admission in the pediatric intensive care unit (PICU) and a 1-month infant died due to respiratory failure. Additional therapeutic agents included dexamethasone (n=18, 78.2%), prophylactic heparin (n=11, 47.8%), antibiotics (n=7, 30.4%), IVIG (n=4, 17.4%) and 1 child received tocilizumab while in PICU.

Conclusions/Learning Points: In our study remdesivir was well tolerated with a low incidence of adverse events. Nonetheless, clinical studies should concentrate on pediatric care, particularly the safety and pharmacokinetics of remdesivir, especially in children under the age of 12.

EP530 / #849

Topic: AS13. COVID 19 and MIS-C

COVID-19 VACCINES AGAINST THE PRE-SARS-COV-2 OMICRON (B.1.1.529) VARIANTS IN CHILDREN WITH MODERATE TO SEVERE SARS COV-2 INFECTION: 6-MONTH FOLLOW-UP

E-Posters

E-POSTER VIEWING

Gonzalo Valenzuela^{1,2,3}, Clara Schulze-Schiappacasse³, Gonzalo Alarcon³, Rocío Rodríguez³, Tamara García-Salum^{1,2}, Javiera Arce³, Carmen Gualteros³, Jorge Levican², Eileen Serrano², Leonardo Almonacid², María José Avendaño², Catalina Pardo-Roa², Monserrat Gutiérrez^{3,4}, Irini Nicolaides^{3,5}, Javiera Aravena^{3,5}, Rafael Medina^{1,2,3,6}

¹Pontificia Universidad Católica de Chile, Department Of Pediatric Infectious Diseases And Immunology, SANTIAGO, Chile, ²Pontificia Universidad Católica de Chile, Laboratory Of Infectious Diseases And Molecular Virology, Santiago, Chile, ³Pontificia Universidad Católica de Chile, Department Of Pediatrics, Santiago, Chile, ⁴Hospital Dr Sótero del Río, Paediatric Unit, Santiago, Chile, ⁵Hospital La Florida Dra. Eloísa Díaz Insunza, Pediatric Unit And Department Of Emergency, Santiago, Chile, ⁶Icahn School of Medicine at Mount Sinai, Department Of Microbiology, New York, United States of America

Backgrounds: Vaccination against COVID-19 in children has recently been approved in different countries. Multiple vaccination schedules, including boosters or heterologous vaccines, have been proposed. In turn, vaccination effectiveness in patients with moderate to severe COVID-19 is scarcely known. We describe the vaccination schedules of pediatric patients infected by SARS-CoV-2 and their reinfection events.

Methods: Descriptive multicenter study conducted in Chile. We included children with moderate and severe COVID-19 (2020-2021). Patients who died or were vaccinated prior to hospitalization were excluded. Vaccination schedules included CoronaVac for emergency use in children over 3 years, BNT162b2 vaccine in pediatric patients over 5 years and Ad5-nCoV vaccine in patients over 18 years. COVID-19 reinfection was defined as individuals infected with different genetic strains of SARS-CoV-2 confirmed by PCR.

Results: Of a total of 221 COVID-19 inpatients between 2020-2021, 9 patients (4.0%) died, and 2 patients received 1 dose of vaccine prior to infection (0.9%). Of 210 patients, 114 (54.3%) were male. The average age was 8.4 (0-20 years old). Those patients ≥ 3 years correspond to 130 (61.9%). 1107 (82.3%) patients received at least 1 dose of vaccine: 68 (63.6%) CoronaVac, 37 (34.5%) Pfizer, and 2 (1.8%) Ad5-nCoV. The mean time between administration and positive RT-PCR was 227 days (range 40-842). 90 (69.2%) days with complete vaccination, 18 (13,8%) days with booster, and 3 (2,3%) days with heterologous vaccines. No reinfection was detected at follow-up.

Conclusions/Learning Points: In patients with moderate to severe SARS-CoV-2, no reinfections were observed at 6-months follow-up. More research is needed regarding the evolution of immune response against new strains such as Omicron, and in relation to longitudinal follow-up.

EP531 / #1042

Topic: AS13. COVID 19 and MIS-C

DEXAMETHASONE IN HOSPITALIZED CHILDREN WITH COVID-19: A MULTICENTER STUDY

E-Posters

E-POSTER VIEWING

Gonzalo Valenzuela^{1,2}, Rocío Rodríguez², Gonzalo Alarcon², Clara Schulze-Schiappacasse², Tamara García-Salum^{1,2,3}, Jorge Levican², Eileen Serrano², Leonardo Almonacid², María José Avendaño², Catalina Pardo-Roa², Monserrat Gutiérrez^{2,4}, Irini Nicolaidis^{2,5}, Javiera Aravena^{2,5}, Rafael Medina^{1,2,6}

¹Pontificia Universidad Católica de Chile, Laboratory Of Infectious Diseases And Molecular Virology, Santiago, Chile, ²Pontificia Universidad Católica de Chile, Department Of Pediatrics, Santiago, Chile, ³Pontificia Universidad Católica de Chile, Department Of Pediatric Infectious Diseases And Immunology, SANTIAGO, Chile, ⁴Hospital Dr Sótero del Río, Paediatric Unit, Santiago, Chile, ⁵Hospital La Florida Dra. Eloísa Díaz Insunza, Pediatric Unit And Department Of Emergency, Santiago, Chile, ⁶Icahn School of Medicine at Mount Sinai, Department Of Microbiology, New York, United States of America

Backgrounds: Dexamethasone treatment reduces mortality and improves clinical outcomes in adult COVID-19 inpatients. Reports in children are scarce. We aimed to evaluate the association between the use of dexamethasone and severe outcomes in children with COVID-19.

Methods: Retrospective multicenter study conducted in Chile. We included inpatients children with COVID-19 between 2020-2021. We compared patients who received systemic dexamethasone 0.15 mg/kg/dose (maximum 6mg) once daily with patients who receive usual care and did not receive corticosteroids. PIMS and COVID asymptomatic inpatients were excluded. Main outcomes were: Length of stay (LOS), ICU admission, ICU stay, oxygen, ventilatory support, vasoactive drugs and mortality.

Results: A total of 137 patients were included, median age was 10,9 years, 66(48,2%) were male, 70(51,1%) overweight or obese, 64(46,7%) received dexamethasone, 65(47,4%) were admitted to ICU, 51(37,2%) required ventilatory support and 19(13,9%) invasive mechanical ventilation (IMV). We observed in children with IMV who received dexamethasone, mortality was significantly lower OR: 0.033 (95% CI, 0.00 to 0.77). Regarding adverse effects in patients who received dexamethasone, insulin requirements were observed in 5(3.6%), thrombosis in 4(2.9%) and no gastrointestinal bleeding was reported.

Conclusions/Learning Points: As observed in adults, in children hospitalized with COVID-19 who receive dexamethasone resulted in lower mortality among those who were receiving IMV. Further studies are needed to generate recommendations in children.

EP532 / #1378

Topic: AS13. COVID 19 and MIS-C

IMMUNOLOGICAL ASPECTS OF SARS-COV-2 INFECTION IN PAEDIATRIC PATIENTS

E-Posters

E-POSTER VIEWING

Claudia Vanetti¹, Marta Stracuzzi², Claudio Fenizia³, Fiona Limanaqi³, Laura Paradiso², Emma Longoni², Lucia Barcellini⁴, Vito Lampasona⁵, Lorenzo Piemonti⁵, Iliaria Marzinotto⁵, Stefania Dispinseri⁶, Gabriella Scarlatti⁶, Cristian Loretelli¹, Paolo Fiorina¹, Mario Clerici³, Mara Biasin¹, Vania Giacomet², Gian Vincenzo Zuccotti⁴, Daria Trabattoni¹

¹University of Milan, Department Of Biomedical And Clinical Sciences "Luigi Sacco", Milan, Italy, ²University of Milan, Pediatric Infectious Disease, Milano, Italy, ³University of Milan, Department Of Pathophysiology And Transplantation,, Milan, Italy, ⁴Ospedale dei Bambini V. Buzzi, Department Of Paediatrics, Milan, Italy, ⁵Ospedale San Raffaele, Diabetes Research Institute, Milan, Italy, ⁶Ospedale San Raffaele, Viral Evolution And Transmission Unit, Milan, Italy

Backgrounds: Children affected by COVID-19 are more likely to develop mild or asymptomatic clinical presentation compared with adults. Nonetheless, exhaustive reports on specific immune responses to SARS-CoV-2 in paediatric patients remain scarce. The present study aims to characterize the immunological profile in a cohort of SARS-CoV-2-infected children at different ages with different clinical manifestations.

Methods: 18 SARS-CoV-2-infected children were enrolled in the study and compared to 13 age-matched healthy controls. Patients were stratified into pauci-symptomatic/moderate (PM, 55,6%) and severe/critical (SC, 44,5%) cases, as well as according to time from symptoms onset (acute and subacute, cut-off 7 days), and age classes (infants 39%, children 44% and adolescents 17%). A SARS-CoV-2 neutralization activity (NTA) assay was performed and specific antibodies to SARS-CoV-2 as well as HCoV-OC43 and HCoV-HKU1 were tested in plasma. In plasma and in supernatants from PBMC cultures, upon stimulation with SARS-CoV-2-specific antigens, we evaluated anti-viral immune response by gene expression analysis (QuantigenePlex assay) and by evaluation of cytokine concentration (Multiplex Cytokine Array).

Results: A slight tendency towards increased NTA was found in SC, acute and in older cases. SARS-CoV-2 infection in paediatric patients results in hyperactivation of immune response both at RNA and protein level ($p < 0.05$), in comparison to the healthy counterpart. Further increases in SARS-CoV-2-specific immunological markers of cytokine storm, T-cell activation, and inflammasome components occur in the SC and acute cases. Notably, a hyper-inflammatory profile emerged in infants, which is reminiscent of that observed in SC.

Conclusions/Learning Points: In the present study, we characterized immunological aspects in SARS-CoV-2-infected paediatric patients. Our data suggest the existence of specific SARS-CoV-2-induced immunological profiles unraveling correlations with clinical severity, time to symptoms onset and age, which deserve to be further investigated in larger cohort studies.

EP533 / #899

Topic: AS13. COVID 19 and MIS-C

THE BULGARIAN COHORT OF COVID-19 HOSPITALIZED CHILDREN

E-Posters

E-POSTER VIEWING

Petar Velikov, Tatiana Tcherveniakova

Infectious Diseases Hospital "Prof. Ivan Kirov", Clinic Of Pediatric Infectious Diseases, Sofia, Bulgaria

Backgrounds: Bulgaria is a strongly affected country during the COVID-19 pandemic. The spectrum and severity of the disease in children is still unclear.

Methods: We performed a prospective, cross-sectional study and aim to clarify the spectrum of disease in Bulgarian children with COVID-19.

Results: Between 8 March 2020 and 1 June 2021, 132 children were admitted to our hospital: all due to relevant COVID-19 disease. PCR was positive in 90% (119/132) and serology for SARS-CoV-2 IgM and/or IgG was positive for 12% (16/132); 59% (79/132) were male, 52% had contact with a known COVID-19 adult patient, and 31.8% (42/132) had comorbidities. One (0.9%) patient died, who had serious comorbidities. Coinfections were detected in 25% (33/132) patients. Diagnosis in patients admitted with COVID-19 were: pneumonia 34%; upper respiratory tract infection 14%; inflammatory multisystemic syndrome related with SARS-CoV-2 (MIS-C) 16/132 (12%); Urinary tract infection 10%; gastrointestinal symptoms 9%; or bronchiolitis in 3%. 35% of patients needed O₂ and 3% were transferred to the PICU. In the X-ray at admission of 132 patients, 16% had consolidation and 23% had infiltrates. Risk factors for severe outcome (PICU or oxygen therapy) included pneumonia, MIS-C features, age under 1 or between 10 and 14, comorbidities, lymphopenia, increased CRP and increased urea.

Conclusions/Learning Points: COVID-19 in children has a wide range of characteristics and severity. The Bulgarian cohort shows a significant proportion of moderately ill patients.

EP535 / #1335

Topic: AS13. COVID 19 and MIS-C

COVID-19 INFECTION IN CHILDREN; A THREE-MONTH PROSPECTIVE CLINICAL AND LABORATORY FOLLOW-UP

E-Posters

E-POSTER VIEWING

Maria Antoniadou¹, Dimitra - Irinna Vitoratou¹, Patra Koletsis¹, Kyriaki Chorianopoulou², Konstantina Giannakopoulou², Efstathia Staikou², Markos Kalachanis³, Panagiotis Vlismas³, Spiros Massias³, Stavroula Kostaridou¹

¹Penteli Children's Hospital, Paediatric, Penteli, Greece, ²Penteli Children's Hospital, Biopathology Department, Athens, Greece, ³Penteli Children's Hospital, Cardiology, Penteli, Greece

Backgrounds: Robust epidemiologic data confirm the milder course of COVID-19 infection in the pediatric population however data is scarce on potential health consequences. We prospectively followed-up patients younger than 16 years old, diagnosed with COVID-19, three months post-diagnosis, in order to explore for any sequelae associated with COVID-19 infection.

Methods: The COVID-19 registry of Penteli Children's Hospital was accessed, and all pediatric patients diagnosed with SARS-CoV-2 infection between 01/05/2020 and 30/04/2021 were identified. 106 patients were included in the three-month follow-up session, which consisted of demographic and anthropometric data documentation, interview concerning persisting symptoms, physical examination, electrocardiography, and laboratory workup. 60 patients underwent an echocardiogram.

Results: Three patients presented earlier with MIS-C. Of the laboratory work-up conducted, the abnormal values most frequently seen were prolonged APTT (82,7%), followed by high monocyte absolute count (74,5%). Troponin was normal in all subjects except for the MIS-C cases. A negative association between age group and IgG COVID-19 antibody levels was observed ($p=0.03$), whereas no association was found between disease severity or weight status and IgG levels ($p=0.36$ and $p=0.38$ respectively). ECG and echocardiogram did not reveal any new-onset disturbances except for one case with MIS-C where transient AV-block and negative T (I, aVL) were observed. When questioned for persistent symptoms, four patients, aged 8 to 15 years old, reported fatigue and a female adolescent complained of anxiety since admission.

Conclusions/Learning Points: Our findings largely demonstrate a favorable outcome in most patients enrolled, regardless of age, sex, weight status and disease severity.

EP537 / #893

Topic: AS13. COVID 19 and MIS-C

FEATURES OF THE COVID-19 MANIFESTATION IN CHILDREN OF DIFFERENT AGE GROUPS.

E-Posters

E-POSTER VIEWING

Alina Zaretska, Yuriy Kharchenko

Odessa National Medical University, Children Infection Diseases, Odesa, Ukraine

Backgrounds: Most studies focus only on the features of the SARS-Cov-2 disease in adults, despite the increasing number of children infected by it. Thus, the clinical and paraclinical manifestations of COVID-19 in children remain uncertain.

Methods: The study was performed on the Odessa city infectious diseases hospital during April - September 2020. There 60 children aged from 3 months to 18 years with laboratory-confirmed SARS-CoV-2 were examined.

Results: COVID-19 incidences occur in all age groups, and the severity and duration of clinical and paraclinical manifestations were depended on the child's age. The data indicate that the most characteristic manifestations of COVID-19 in children under 3 years of age were acute onset (90.0%) with intoxication (75.0%), fever (60.0%), with nasal congestion (25.0%), rhinorrhea (20.0%), leukocytosis (25.0%), leukopenia (15.0%), anemia (10.0%), increased ESR and C-reactive protein (55.0%) and CT signs of bronchitis (35.0%). The course of COVID-19 in children from 4 to 6 years is characterized by acute onset (85.71%), fever (57.14%), pharyngitis (85.71%), anemia (14.28%), lymphopenia (28.56%), and the absence, according to CT, of bronchial and pulmonary lesions (71.43%). Gradual onset with intoxication (88.89%), headache (16.67%), febrile fever (33.33%), dry cough (77.78%), lymphocytosis (16.67 %) with accelerated ESR (38.89%), and pneumonia (38.89%) is typical for COVID-19 in children from 7 to 12 years. The mildest course (26.67%), fever (46.67%), with loss of smell (20.0%), leukopenia (20.0%), acceleration ESR (20.0%), decreased prothrombin (13.33%), and no bronchial and pulmonary lesions (73.33%), according to CT, were characteristic of the course of COVID-19 in children aged from 13 to 18 years.

Conclusions/Learning Points: The severity and duration of clinical symptoms of COVID-19 depend on the child's age. The acutest and varied course was observed in children under 3 years.

EP539 / #770

Topic: AS14. Microbiome

CHRONIC ISOLATION OF BLASTOBOTRYS SPECIES IN SPUTUM OF A CHILD WITH CYSTIC FIBROSIS

E-Posters

E-POSTER VIEWING

Angeliki Stathi¹, Argyri Petrocheilou², Helen Kirikou¹, Anastasia Vardakastani¹, Afroditi Milioni³, Stavroula Kritikou³, Aristeia Velegraki^{3,4}, Malamati Mika¹, Ioanna Loukou², Levantia Zachariadou¹
¹"Aghia Sophia" Children's Hospital, Microbiology, Athens, Greece, ²"Aghia Sophia" Children's Hospital, Cystic Fibrosis, Athens, Greece, ³Medical School, National and Kapodistrian University of Athens, Mycology Research Laboratory & Uoa/hcpf Culture Collection, Athens, Greece, ⁴BIOMEDICINE S.A., Mycology Laboratory, Athens, Greece

Title of Case: CHRONIC ISOLATION OF BLASTOBOTRYS SPECIES IN SPUTUM OF A CHILD WITH CYSTIC FIBROSIS

Background: Recently discovered, anamorphic fungi *Blastobotrys adenivorans* and *Blastobotrys raffinosa* are rarely reported in human infection, mostly in immunocompromised and cystic fibrosis patients (CF). Chronic *Blastobotrys* species isolation from the sputum of a child with CF is reported.

Case Presentation Summary: The case concerns an 11-year-old boy diagnosed with CF right at birth. He was colonized with *Pseudomonas aeruginosa* at the age of 9-months, and with *Candida albicans* one-year later. From the age of 3-years, *Staphylococcus aureus*, *Stenotrophomonas maltophilia*, along with *C. albicans*, non-*albicans*-yeasts and sporadically *P. aeruginosa* were isolated. He is admitted to the hospital every 3-month for iv-antibiotics and, in the interim, often needs oral antibiotics due to frequent pulmonary exacerbations-increased cough and/or hemoptysis, since early childhood. Azithromycin was added at the age of 6-years and *B. raffinosa* and *B. adenivorans* appeared in sputum cultures. Within one-year, *S. aureus* disappeared first, followed by *P. aeruginosa* and finally *S. maltophilia*. *Blastobotrys* species dominated exclusively ever with *C. albicans* until today. VITEK-2 (Biomérieux®) and MALDI-TOF/MS (Biotyper3.1-BRUKER®), failed to identify both *Blastobotrys* isolates, whereas sequencing of domains ITS1/ITS2-region did. Antifungal susceptibility testing (MIC-Test Strips™-Liofilchem®) for both species showed low MIC (µg/mL) values for isavuconazole(0.095), amphotericin(0.125), micafungin(0.32), caspofungin(0.38), anidulafungin(0.38), itraconazole(0.75), posaconazole(1.5) and reduced susceptibility to fluconazole(256), voriconazole(32) and flusytosine(32). Treatment with micafungin was associated with improved clinical course and posaconazole with reduced hemoptysis episodes.

Learning Points/Discussion: The rarity of cases with chronic isolation of *Blastobotrys* species from respiratory samples in CF patients, combined to the disappearance of other microbes raises the matter of the interactions of these fungi within CF lung microbiome. As *Blastobotrys* species is not identified using standard diagnostics, the fungus may be underreported.

EP540 / #1364

Topic: AS15. Prolonged / recurrent fever

KAWASAKI DISEASE IN INFANTS LESS THAN 6 MONTHS: A RETROSPECTIVE STUDY IN A TERTIARY GREEK CHILDREN'S HOSPITAL.

E-Posters

E-POSTER VIEWING

Konstantinos Brachos¹, Marina Letsiou¹, Eleftheria Fotopoulou¹, Anastasia Manoli¹, Elisavet Kotsi¹, Spiridon Massias², Panagiotis Vlismas², Patra Koletsis¹, Paraskevi Korovessi¹

¹Penteli Children's Hospital, Department Of Pediatrics, Athens, Greece, ²Penteli Children's Hospital, Cardiology Unit, Athens, Greece

Backgrounds: Kawasaki disease (KD) is the predominant cause of acute vasculitis especially in children under 5 years. However, limited studies are focused on infants under 6 months. The purpose of this study is to investigate the incidence, clinical characteristics, laboratory findings and echocardiographic data of KD in infants under the age of 6 months.

Methods: We retrospectively reviewed the medical records of 28 children with KD admitted to Penteli Children's Hospital during the last five years.

Results: We identified 28 KD patients, of which 5 (18%) were ≤ 12 months, and 4 (14%) were ≤ 6 months. Among infants below six months (mean age 3.6 ± 0.7 months), mean time to presentation to our hospital was 6.2 ± 2.5 days, and mean time to diagnosis was 8 ± 2.5 days. The most frequent clinical finding was rash (75%), while lymphadenopathy and extremity changes were present in 50% and conjunctival injection in 25%. None of the infants had oral mucosal changes. Incomplete KD was diagnosed in 75%. All infants had anemia. Elevated WBC and decreased albumin was present in 75%, followed by elevated platelets (50%), and increased ALT (25%). None of them had aseptic pyuria. Three out of four infants had cardiac involvement thus long-term follow-up was required. Two had high z-scores of coronary artery diameter (2,39 and 3,54 respectively) and the third had right coronary artery aneurysm. All KD infants received treatment with intravenous immunoglobulin and had an uneventful recovery.

Conclusions/Learning Points: Infants under 6 months with KD commonly present with incomplete form. Most of them had cardiac involvement. Therefore KD should be suspected in infants with unexplained fever and echocardiography is essential since coronary artery dilatation is often observed in this high-risk age group.

EP541 / #1837

Topic: AS15. Prolonged / recurrent fever

PLASMODIUM FALCIPARUM MALARIA IN IRELAND WITHOUT RECENT TRAVEL TO MALARIA-ENDEMIC COUNTRY

E-Posters

E-POSTER VIEWING

Rema Buzeid

our lady of lourdes droghea hospitald hospital, Paediatric, Drogheda, Ireland

Title of Case: Plasmodium falciparum Malaria in Ireland without Recent Travel to Malaria-Endemic Country .

Background: In Europe, imported malaria cases occur due to returning travellers or immigration mostly from African countries.

Case Presentation Summary: a 1 year old female from the Nigerian community born in Ireland. She presented to Portlaoise hospital due to sustained fever and cough for 10 days prior to admission . She was treated in the community for a LRTI . She had no jaundice, vomiting or diarrhoea .she had no underlying disease . She had never been abroad and attained her normal milestones. Her father had recently returned from Lagos(Nigeria) and had received both pre and post malaria vaccines. Clinical assessment revealed a high-grade fever , heart rate 167 bpm, oxygen saturation 98% and respiratory rate 67 breaths/minute. She looked unwell ,irritable ,pallor. Her breath sound was normal. Her liver was mildly enlarged with sharp margins .Laboratory studies showed a haemoglobin concentration of 7.7g/dL, a haematocrit 38.0% and a white cell count 4 with 70% neutrophils, 11.2% lymphocyte, reticulocyte 1%. The platelet count was 77 . Her peripheral blood smear showed normochromic red blood cells with several target cells and few basophilic stipplings, and few ring-form trophozoites of P falciparum in normal-sized red cells , parasitaemia (1.3%). Her CRP was 44 mg/dl. The patient received artesunate intravenously 3 doses . Then artesunate was switched to an oral Riamet for 3 days . She was discharged home well , continued anti malaria treatment and for a review in 3 months.

Learning Points/Discussion: The physicians should be aware of the possibility of Plasmodium falciparum infections in patients who have been in contact with travellers who recently returned from malaria-endemic area (luggage, airport, local transmission)..

EP542 / #681

Topic: AS15. Prolonged / recurrent fever

RASH AND FEVER IN A TEENAGER - EXPLORING INFECTIOUS AND INFLAMMATORY ETIOLOGIES

E-Posters

E-POSTER VIEWING

Ana João Fernandes¹, Lídia Leite¹, Cláudia Patraquim¹, Iva Brito^{2,3}, Helena Silva¹, Maria Miguel Gomes^{1,4}
¹Hospital de Braga, Pediatria, Braga, Portugal, ²Centro Hospitalar São João, Reumatologia Pediátrica E Jovem Adulto, Porto, Portugal, ³Universidade do Porto, Faculdade De Medicina, Porto, Portugal, ⁴Universidade do Minho, Escola De Medicina, Braga, Portugal

Title of Case: Rash and fever

Background: Fever and rash are common complaints in children and may have an inflammatory or infectious etiology. Mediterranean spotted fever (MSF) is a disease caused by *Rickettsia conorii* that presents with fever and a characteristic rash.

Case Presentation Summary: Fifteen-years-old girl presented with four-day history of fever, pruriginous rash with caudocephalic progression involving the palms and soles, hand finger edema, odynophagy, myalgias, nausea and anorexia. She was previously healthy and there was no familiar history of immunologic or other diseases. The day before the complaints, she had an outdoor activity with the scouts but there was no notion of bite. Physical examination showed generalized maculopapular rash and right cervical adenopathy. Laboratory tests revealed elevation of inflammatory markers (C-reactive protein 150mg/L and sedimentation rate 82mm/h) but without leukocytosis. By the seventh day of fever there was worsening of inflammatory markers and doxycilin was started due to the suspicion of MSF. By the tenth day of fever she presented with hand finger arthralgia and evanescent rash. An autoinflammatory syndrome was suspected and ibuprofen was started. After 48-hours of treatment there were no clinical or analytical changes and treatment with methylprednisolone pulses was started. Since the beginning of corticotherapy there was lowering of inflammatory markers and the teenager remained afebrile. She was discharged after 4 days of afebrile and maintained treatment with oral prednisolone. *Rickettsia conorii* serology was initially positive for IgM and negative for IgG. Four weeks later serology was negative for both IgM and IgG which did not confirm the diagnosis of MSF.

Learning Points/Discussion: Authors present this case given the importance of differential diagnosis. Even if the patient has suggestive clinical and epidemiological context for MSF clinicians should never forget autoinflammatory syndromes.

EP543 / #300

Topic: AS15. Prolonged / recurrent fever

ANTIBIOTIC USE IN CHILDREN WITH KAWASAKI DISEASE

E-Posters

E-POSTER VIEWING

Yejin Kim¹, Soo-Young Lee²

¹St. Vincent's Hospital, College of Medicine, The Catholic University of Korea, Department Of Pediatrics, Suwon, Korea, Republic of, ²Bucheon St. Mary's Hospital, College of Medicine, The Catholic University of Korea, Department Of Pediatrics, Bucheon, Korea, Republic of

Backgrounds: As the diagnostic criteria for Kawasaki disease (KD) consist of the clinical features that are shared by other childhood febrile illnesses, KD is sometimes confused with a bacterial infection, leading to clinical situations in which children with the disease receive antibiotics. Here, we report the extent of antibiotic use in children with KD and the clinical parameters confusing KD with a bacterial infection.

Methods: Medical records of 140 children who were diagnosed with KD at the study hospital were retrospectively reviewed. The diagnosis of KD was based on American Heart Association criteria. All children with KD received treatment with intravenous immunoglobulin (2 g/kg/dose) and underwent echocardiography during hospitalization. Depending on whether antibiotics were treated, the child was assigned to two groups: KD with antibiotics or KD without antibiotics.

Results: Of the children with KD, 54.3% (76/140) received treatment with intravenous antibiotics (ampicillin/sulbactam or cefotaxime 100-200 mg/kg/day). The clinical and laboratory findings between the KD with antibiotics group (n=76) and the KD without antibiotics group (n=64) were compared. The KD with antibiotics group was younger ($P<0.001$), experienced longer hospital stay ($P=0.045$), showed higher values of leukocyte count ($P=0.005$) and C-reactive protein (CRP, $P=0.005$), and possessed more cases with pyuria ($P=0.034$) than the KD without antibiotics group. There were no pathogens isolated from bacterial cultures in both groups.

Conclusions/Learning Points: A relatively high proportion (54.3%) of children with KD receive antibiotics in actual practice. Because their clinical and laboratory findings in the acute phase did not fulfil the diagnostic criteria for KD but rather suggested bacterial infections, the children with KD received antibiotics. The clinical parameters confusing KD with a bacterial infection were young age, leukocytosis, increased CRP levels and the presence of pyuria.

EP544 / #301

Topic: AS15. Prolonged / recurrent fever

ARE CORONARY ARTERY LESIONS PATHOGNOMONIC OF KAWASAKI DISEASE? - A MURINE MODEL OF SEPSIS AND A REVIEW OF THE LITERATURE

E-Posters

E-POSTER VIEWING

Soo-Young Lee¹, Yeji Kim²

¹Bucheon St. Mary's Hospital, College of Medicine, The Catholic University of Korea, Department Of Pediatrics, Bucheon, Korea, Republic of, ²Seoul St. Mary's Hospital, College of Medicine, The Catholic University of Korea, Department Of Pediatrics, Seoul, Korea, Republic of

Backgrounds: We hypothesize that coronary artery lesions (CALs) are not pathognomonic of Kawasaki disease (KD), but may be observed in children with various diseases that cause severe inflammation. The purpose of this study was to observe CALs in a murine model of sepsis and to review the literature supporting our hypothesis.

Methods: To induce sepsis, 6-week-old C57BL/6 mice were intraperitoneally injected with endotoxin on days 0, 2, 5, 7, and 9. Histological findings of the major organs (i.e., heart, liver, and kidney) were compared between the sepsis and the control. The hearts of the septic mice were further examined to observe CALs. A PubMed search was performed for literature review.

Results: Infiltrating inflammatory cells were relatively increased in the heart, liver, and kidneys of the sepsis group, compared with those of the control group. Lymphocytic infiltration was identified in pericardial soft tissue and myocardium (myocarditis) of septic mice. Coronary arteries were found, but no CALs were observed in septic mice. A literature review has demonstrated the presence of CALs in a variety of childhood diseases: Epstein-Barr virus or cytomegalovirus infection, rabies, Escherichia coli sepsis, toxic shock syndrome, viral myocarditis, Takayasu arteritis, juvenile idiopathic arthritis, rheumatic fever, leukemia, and hemophagocytic lymphohistiocytosis.

Conclusions/Learning Points: We did not observe CALs in a murine model of sepsis. However, we found many studies of CALs development in childhood diseases other than KD. The presence of CALs may indicate the severity of the inflammation rather than the cause of the inflammation. Subsequent studies are needed to evaluate the clinical significance of CALs in children.

EP545 / #886

Topic: AS15. Prolonged / recurrent fever

A RARE CASE OF SYSTEMIC JUVENILE IDIOPATHIC ARTHRITIS (SJIA) IN A 10-MONTH-OLD INFANT INITIALLY DIAGNOSED AS MIS-C

E-Posters

E-POSTER VIEWING

Despoina Tatarioti¹, Konstantina Patouni², Despoina Maritsi³, Anastasia Koutsaki¹, Dimitrios Delis⁴, [Mersyni Mavrikou](#)⁴

¹"P& A Kyriakou" Children's Hospital, First Paediatric Department, Athens, Greece, ²P&A Kyriakou Children's Hospital, First Paediatric Department, Athens, Greece, ³"P& A Kyriakou" Children's Hospital, Second Department Of Paediatrics, National And Kapodestrian University Of Athens, Athens, Greece, ⁴"P&A Kyriakou" Children's Hospital, First Paediatric Department, Athens, Greece

Title of Case: A rare case of systemic juvenile idiopathic arthritis (sJIA) in a 10-month-old infant initially diagnosed as MIS-C

Background: sJIA is a multisystem inflammatory disease accounting for 10–20% of JIA cases that rarely affects infants. Clinical manifestations vary among young children. Immune system reaction is mainly activated by interleukin-1 and interleukin-6. Newly emerging biologic agents targeting those markers showed promising results.

Case Presentation Summary: A previously healthy 10-month-old female infant was admitted with a two day history of high fever, rash and diarrhea. Clinical examination was otherwise unremarkable. Inflammatory markers were highly elevated. Therefore, wide-spectrum antibiotics were administered. Due to the continuation of fever, two systems involvement (skin, gut) and increased inflammatory markers, the clinical suspicion of MIS-C emerged. Treatment with IVIG, methylprednisolone and aspirin was initiated. Echocardiogram and abdominal ultrasound were normal. Testing for infectious causes including Sars-Cov-2 serology was negative. NGS was performed in order to screen for antoinflammatory diseases presenting in the infantile age with prolonged fever and systemic inflammation. No mutations were detected. Despite the aforementioned treatment, clinical manifestations including high fever and widespread evanescent salmon-pink maculopapular rash did not subside. Inflammatory markers remained high. Diagnosis of MIS-C was revisited and the clinical suspicion of sJIA emerged. Treatment with anti-IL-6 agent was initiated. Subsequently, fever subsided and inflammatory markers improved. The infant was discharged in excellent condition, with a milder rash appearing during evening hours. Two months after discontinuation of corticosteroids, she suffered a relapse and was treated successfully with an anti-IL-1 β blocker (canakinumab). She remains in remission ever since.

Learning Points/Discussion: Clinical presentation of sJIA can be non-specific among infants and diagnosis may delay, especially during Covid-19 pandemic. Biologic agents have gained a major role in sJIA therapy with encouraging results.

EP546 / #1796

Topic: AS15. Prolonged / recurrent fever

FEVER, ORGANOMEGALY AND PANCYTOPENIA: A CASE OF VISCERAL LEISHMANIASIS (VL)

E-Posters

E-POSTER VIEWING

Behrouz Nezafat Maldonado¹, Shivani Shah², Wolfgang Muller², Amanda Williams², Bhanu Williams²
¹Imperial College London, School Of Public Health, London, United Kingdom, ²Northwick Park Hospital, Paediatrics, London, United Kingdom

Title of Case: FEVER, ORGANOMEGALY AND PANCYTOPENIA: A CASE OF VISCERAL LEISHMANIASIS (VL)

Background: Pyrexia of unknown origin can present a diagnostic conundrum for paediatricians. In this case an extensive workup revealed a diagnosis of VL four weeks after initial presentation.

Case Presentation Summary: A healthy six-year-old boy presented to the emergency department with a three-week history of persisting pyrexia, associated with two weeks of night sweats and rigors. He had no history of anorexia, weight loss or recent travel. He looked well but hepatosplenomegaly and pallor were present. Initial investigations found pancytopenia: anaemia (79g/L), neutropenia ($0.9 \times 10^9/L$), thrombocytopenia $117 \times 10^9/L$. The initial diagnosis was of probable haematological malignancy; differentials included EBV, CMV and vasculitis. Bone marrow biopsy showed no evidence of malignancy and histology was negative. Further travel history at the tertiary unit had revealed travel to France and Spain in the previous 18 months. In view of this, further investigations were recommended by infectious diseases specialists. *Leishmania donovani* PCR was positive and later antibodies to *L donovani* were detected in the peripheral blood. A 10-day course of intravenous Liposomal Amphotericin B was commenced with resolution of fevers within 48 hours and normalisation of cell lines by 3 months. At 6 months he remained systemically well and hepatosplenomegaly had resolved.

Learning Points/Discussion: The case illustrates how early involvement with specialist centres and an initial comprehensive travel history covering at least the last two years may expedite diagnosis. VL endemicity is a re-emerging problem in Europe, has an incubation period of 10 days-24 months and is thus an important differential diagnosis. The case highlights the need to consider a broader spectrum of infectious agents within the differential diagnosis due to changes in the distribution of vector-borne diseases resulting from climate change.

EP547 / #773

Topic: AS15. Prolonged / recurrent fever

FEVER OF UNKNOWN ORIGIN IN A 12-YEAR-OLD GIRL – CASE REPORT

E-Posters

E-POSTER VIEWING

Ana Sofia Nunes, Mariana Pereira, Ana Antunes, Margarida Reis Morais
Hospital de Braga, Department Of Paediatrics, Braga, Portugal

Title of Case: FEVER OF UNKNOWN ORIGIN IN A 12-YEAR-OLD GIRL – CASE REPORT

Background: Fever of unknown origin (FUO) is defined as rectal temperature above 38.3°C, for ≥8 days, when no diagnosis is identified after an appropriate clinical history and physical examination. FUO has multiple causes including infectious, rheumatologic and neoplastic diseases.

Case Presentation Summary: Healthy 12-year-old girl was admitted with a 7-day history of fever, intermittent posterior pleuritic chest pain and generalized myalgia. Cough, dyspnea, rash or arthralgia were denied. She had sporadic contact with stray cats in past months. She had already completed four days of azithromycin and was on the third day of amoxicillin/clavulanic acid, with no improvement. Physical examination was normal. Analytically: slight leukocytosis, neutrophilia and increased inflammatory markers; normal cardiac biomarkers except NT-proBNP (157pg/mL); negative blood culture; doubtful Epstein Barr Virus (EBV) viral capsid IgM and positive IgG, negative IgG early and nuclear antigens; negative Paul-Bunnell test and SARS-CoV-2. Chest radiography, abdominal ultrasound and electrocardiogram were normal. Echocardiogram showed a small pericardium effusion, so she started a 2-week ibuprofen treatment in a tapered way. Rheumatology and Ophthalmology evaluations were normal.

The ongoing treatment was stopped but the persistence of fever (D8) led to prescription of ceftriaxone for 7 days.

Apyretic since D10 of disease, with clinical and analytical improvement, she was discharged to outpatient follow up. One week later, Bartonella henselae antibodies were available (IgM 1:200/IgG 1:1280) and she repeated azithromycin.

Learning Points/Discussion: This case highlights that FUO can be the only symptom of cat-scratch disease.

We intend to discuss the possibility of a cross-reaction between EBV and B. henselae antibodies, as described in literature.

Given the lack of response to prior azithromycin treatment, an EBV co-infection may explain the persistence of fever.

EP548 / #489

Topic: AS15. Prolonged / recurrent fever

PYREXIA OF UNKNOWN ORIGIN IN CHILDREN: 3 YEAR EXPERIENCE IN A TERTIARY LONDON HOSPITAL DURING THE COVID-19 PANDEMIC

E-Posters

E-POSTER VIEWING

Eleni Papachatzzi¹, [Harsita Patel](#)², Alison Kent¹, Hermione Lyall¹, Elizabeth Whittaker¹

¹Imperial Healthcare NHS Trust, Paediatric Infectious Diseases, London, United Kingdom, ²Imperial College London, Infectious Disease, London, United Kingdom

Backgrounds: Pyrexia of unknown origin (PUO) in children remains a clinical challenge. Despite improvements in diagnostic and management approaches, the aetiology of >50% of cases is unknown. We describe our experience of PUO before and during the COVID-19 pandemic.

Methods: Anonymised data from referrals to paediatric infectious disease (PID) services were collected retrospectively between 01/01/2019 – 31/12/2021. Pyrexia of unknown origin was defined as undifferentiated fever for ≥ 7 days.

Results: 66 patients with PUO were referred over the study period (4.2% of referrals). The majority were from paediatric wards (92.4%), with the remainder from intensive care units (3%), general practitioners (1.5%) and emergency departments (1.5%). 40 (60.6%) were managed locally and of these 5 had PID follow-up, 21 (31.8%) were transferred to our center, 5 (7.6%) were transferred to another tertiary hospital (for services not available at our center e.g. cardiology/rheumatology). Details of 17 transfers are available in Table 1. The median age was 4 years (IQR 2-9), 10 (59%) were females and 2 (12%) had serious co-morbidities. Identified causes included: infection 5/17 (29%), inflammatory 4/17 (24%) and malignancy 1/17 (0.06%). In 7/17 (41%) no aetiology was found. Of the 45 cases not transferred to our center, identified causes included: infection 3/45 (6.7%), inflammatory 3/45 (6.7%) and multisystem inflammatory syndrome in children (MIS-C) 1/45 (2.2%), with no cause identified in 38/45 (84%).

Table 1: Clinical details of patients transferred to our centre with pyrexia of unknown origin. Abbreviations: M – male, F – female, UTD – up to date, GDD – global developmental delay, NPA – nasopharyngeal aspirate

| Patient (Age, Gender) | Reason for referral | Past medical history/ immunisations | Diagnosis | Category |
|-----------------------|---|---|--|--------------|
| 2y, M | fevers, generalised lymphadenopathy, hepatomegaly and anaemia | Nil UTD, no BCG scar | 1. Likely bacterial infection 2. Influenza A/ Rhinovirus/Enterovirus positive (NPA) 3. Adenovirus (stools) | Infection |
| 2y, F | 3/52 fevers, lethargy, diarrhoea, reduced appetite, mosquito bite marks | Nil UTD except BCG | Likely viral illness | Infection |
| 9y, F | 9/7 fever, headache, lethargy | Nil UTD | Disseminated TB | Infection |
| 16y, F | fevers, abdominal pain, ovarian nodules and abdominal lymph nodes on USS | Mild asthma UTD | Abdominal TB | Infection |
| 16y, F | fever, hilar LN, cavitating lesions | GDD UTD, no BCG scar | Pneumonia, likely secondary to aspiration | Infection |
| 6y, M | recurrent fevers, intermittent abdominal pain, mild hepatosplenomegaly | Anaemia, Vitamin D deficiency UTD | Post streptococcal inflammatory syndrome | Inflammatory |
| 9y, F | 8/7 fever, rash | Nil UTD | Juvenile idiopathic arthritis | Inflammatory |
| 4y, M | 6/52 fevers, intermittent rash, stiff gait | Nil UTD | Systemic juvenile idiopathic arthritis | Inflammatory |
| 2y, M | fevers 1 year, periodic 2-3 weeks | Eczema only BCG | Presumed auto-inflammatory disorder, CARD 14 gene deficiency | Inflammatory |
| 6y, M | 5/52 fever, night sweats, rigors, vomiting, weight loss, abdominal pain | Chronic HBV UTD | Hodgkin's Lymphoma | Malignancy |
| 13y, F | fevers, persistent right-sided cervical lymph node, lethargy, poor appetite, leg pains, headaches | 34/40, Mild asthma, Tonsillectomy UTD except BCG, HPV | Not known | Not known |
| 0.19y, M | 10/7 fever, vomiting, decreased feeds, decreased wet nappies, diarrhoea, low CRP | Nil UTD | Not known | Not known |
| 2y, M | fever, diarrhoea and vomiting, lethargy, pancytopenia, tonsillitis | Nil UTD, no BCG scar | Not known | Not known |
| 0.83y, F | 3/52 fever, no focus | 36/40, PROM UTD | Not known | Not known |
| 1y, F | prolonged fever, no focus, neutropenia | Failure to thrive No 12m immunisations | Not known - remains admitted to hospital | Not known |
| 7y, F | prolonged fever, rigors, abdominal pain not responding to antibiotics | Mild asthma, eczema UTD | Not known | Not known |
| 4y, F | 11/7 fevers, abdominal pain, vomiting | Viral induced wheeze, Cow's milk protein intolerance UTD | Extensive enterocolitis of uncertain aetiology | Not known |

Conclusions/Learning Points: Reassuringly, the majority of the persistent fevers in children resolve,

even without a specific diagnosis. Of note, there has not been an increase in PUO cases during the COVID-19 pandemic. Finally, in cases where the cause of PUO is identified, infective and inflammatory conditions are most common, highlighting the importance for joint management with rheumatology.

EP549 / #423

Topic: AS15. Prolonged / recurrent fever

AMEBIC LIVER ABSCESS AS THE CAUSE OF FEVER OF UNKNOWN ORIGIN IN AN INFANT

E-Posters

E-POSTER VIEWING

Elda Skenderi

University Hospital Center "Mother Teresa", Tirana, Albania, Pediatrics, Tirana, Albania

Title of Case: Amebic Liver Abscess as the Cause of Fever of Unknown Origin in an Infant

Background: Amebiasis is a parasitic infection caused by the protozoal organism *Entamoeba histolytica*. *E. histolytica* is capable of causing a spectrum of illnesses from asymptomatic infection to dysentery and invasive extraintestinal conditions, most common of which is amebic liver abscess. It is transmitted through the fecal-oral route. Infective cysts, can be found in fecally contaminated food, water supplies and hands of food handlers.

Case Presentation Summary: A 14-months old boy presented with a history of 10-days fever 38-39°C, and loose stools 3-4 times a day. He was treated with oral antibiotics but fever persisted. On physical examination he appeared moderately ill, no abnormalities were found. Laboratory examinations revealed leukocytosis (WBC=17,300cells/mm³), mild anemia (RBC=3,280,000cells/mm³, hemoglobin=9.5g/dL), and elevated transaminases (ALT=133U/L, AST=96U/L). Blood and urine cultures were negative. CMV, EBV and Salmonellosis, Brucellosis, Rickettsiosis serology were negative. Radiologic examination of the respiratory system and abdominal ultrasound revealed no abnormalities. After 1 week of hospitalization no diagnosis was made and fever persisted. A total body CT was ultimately performed and discovered a liver abscess (1.7cm x 1.3cm). Serologic examination for *E. histolytica* resulted positive. Treatment with metronidazole was initiated and fever subsided on the third day.

Learning Points/Discussion: To highlight the fact that amebic liver abscess is a potential cause of pediatric Fever of Unknown Origin (FUO). Amebic liver abscess is the most common manifestation of amebiasis and a potential cause of FUO in children. It is more prevalent in developing countries but with the increasing phenomena of migration and agriculture tourism it is found worldwide.

EP550 / #1519

Topic: AS15. Prolonged / recurrent fever

INFECTIVE ENDOCARDITIS DUE NUTRITIONALLY VARIANT STREPTOCOCCI IN CHILDREN: A REPORT OF 2 CASES.

E-Posters

E-POSTER VIEWING

Pamela Zacasa, Luis Lozano Vázquez, Eduardo Arias De La Garza
National Institute of Pediatrics, Infectious Diseases, Mexico City, Mexico

Title of Case: INFECTIVE ENDOCARDITIS DUE NUTRITIONALLY VARIANT STREPTOCOCCI IN CHILDREN: A REPORT OF 2 CASES.

Background: There are only 17 cases of pediatric Infective endocarditis (IE) by Nutritionally variant Streptococci (NVS) reported worldwide. We report two cases of IE due NVS.

Case Presentation Summary: Case 1: 8-year-old female, with patent arterial duct, and 6 months of fever, hyporexia, weight loss, fatigue, arthralgia, and paleness. Was admitted with diagnosis of fever of unknown origin. Trans-thoracic echocardiogram (TTE) without abnormalities, but isolation of *Granulicatella elegans* in three peripheral blood cultures established suspicion of IE and antibiotic treatment was initiated. Patient showed good response with cessation of symptoms. At day 28th of treatment was programmed for surgical correction of PAD. A second TTE reported a vegetation (13 mm x 3 mm) on pulmonary valve, surgically removed without complications. Received 44 days of ceftriaxone and 10 days of gentamicin, remaining asymptomatic on follow up. Case 2: 6-year-old female, previously healthy with 4 weeks of lower right limb weakness, and daily non-quantified fever. At admission: decreased response to stimuli, caries, and grade V/VI heart murmur. TTE shows two hyperechogenic images (9x5.1mm and 10x5.7mm) on mitral valve, a third image (9x9 mm) on tricuspid valve, tendinous cords rupture, four chambers dilation, and pericardial effusion. Blood cultures reported growth of *Abiotrophia defectiva*, adjusting antibiotic therapy to IV G Penicillin plus Gentamicin. Brain MRI with ischemic areas on both hemispheres. On day 38 of treatment: vegetation resection and valve reconstruction without complications, is discharged after 55 days of antibiotics.

Learning Points/Discussion: NVS are fastidious organisms which cause unspecific clinical manifestations, with frequent development of complications and 20% mortality, must be suspected in IE cases without a microbiological isolation, prolonged fever, and presence of another risk factors.

EP551 / #374

Topic: AS16. Others

STEROID USE AND OUTCOME IN CULTURE-PROVEN COMPLICATED ENTERIC FEVER IN A TERTIARY CARE HOSPITAL, KARACHI, PAKISTAN.

E-Posters

E-POSTER VIEWING

Falak Abro, Sonia Qureshi, Nasheet Sagri, Farah Qamar
Aga Khan University Hospital, Karachi, Karachi, Pakistan

Backgrounds: Typhoid fever is a potentially serious multi-systemic illness caused by *Salmonella typhi*. However, data on the use and outcome of steroids along with anti-microbial therapy in complications of typhoid fever is scarce. The study aimed to review and report the indications, dose, and outcomes of steroids used in cases of complicated enteric fever in children admitted with complicated enteric fever at a tertiary care hospital, Karachi.

Methods: A retrospective review of files of 109 children with culture-proven complicated enteric fever, conducted at the Aga Khan University Hospital (AKUH), Karachi from January 2017 to December 2019. Statistical analysis was performed on SPSS version 22 software.

Results: Out of 109 patients, 52 (47.7%) received steroids and 57 (52.29%) did not receive steroids. The time to defervescence and length of hospital stay in children who did not receive steroids was significantly longer compared to children who received steroids; median (IQR) 16 (12-19) and 10 (7-14); $p=0.002$ and 6 (5.0-8.0), 5(4.0-6.0); $p=0.01$ respectively. The median (IQR) steroid loading dose was 24.5 (5-40) mg and the maintenance dose was 10 (5-15) mg. Steroids were most commonly prescribed for cases with pleural effusion 31(59.6%), colitis 12 (23%), septic shock 18 (34.6%), intensive care admission 16 (30.8%), encephalopathy, 5 (9.6%) and multi-organ dysfunction 5 (9.6%). Four (7.6%) of 52 patients with severe illness who received steroids expired.

Conclusions/Learning Points: Our study concludes that indications and doses of steroid use in complicated enteric fever are variable. The use of steroids has a beneficial effect on defervescence and length of hospital stay. However, larger clinical trials are needed to determine the appropriate use of steroids in enteric fever.

EP552 / #1015

Topic: AS16. Others

A RARE CASE OF BRAIN ABSCESS CAUSED BY ACTINOMYCES IN AN IMMUNOCOMPETENT CHILD: A CASE REPORT AND LITERATURE REVIEW.

E-Posters

E-POSTER VIEWING

Bandar Albaradi, Abdalazeem Hamad

King Fahad Specialist Hospital, Pediatric Infectious Diseases, Dammam, Saudi Arabia

Title of Case: A RARE CASE OF BRAIN ABSCESS CAUSED BY ACTINOMYCES IN AN IMMUNOCOMPETENT CHILD: A CASE REPORT AND LITERATURE REVIEW

Background: Actinomyces species occur worldwide, being components of endogenous oral and gastrointestinal tract flora. Actinomycosis is an uncommon, chronic granulomatous disease caused by the filamentous, gram-positive bacterium *Actinomyces israelii*. Infection is uncommon in infants and children. A high level of suspicion is required for diagnosis, as it may be missed or mistaken for malignancy. Severe cases involve the central nervous system.

Case Presentation Summary: We report a case of a 13-year-old boy, a healthy child, who presented with focal convulsion. No history of fever and no meningeal signs. CT brain showed left frontal irregular-shaped hyperdense lesion with central hypodensity. It exerts local mass effect on adjacent brain parenchyma resulting in effacement of the adjacent sulci and 7 mm left-to-right midline shift (figure 1). He underwent brain abscess drainage. The abscess wall was thick and adherent to the cortex. The collection was a thick cheesy white material (figure 2). HIV, TB workup, and immunological workup all are negative. Gram stain and initial bacterial culture for brain abscess were negative, however, after extension incubation for anaerobic culture (14 days instead of 7 days) the growth of *Actinomyces* spp. were identified (figure 3). The patient completed six weeks on Meropenem and Vancomycin in high Doses, then shifted to high doses of oral Amoxicillin for a total of 12 months. Recovery was full with no recurrence of brain abscess after six months of follow-up.

Learning Points/Discussion: Although rare, *Actinomyces* brain abscess can be disseminated and fatal. We emphasize the importance of early surgical drainage of the brain abscess combined with a prolonged course of appropriate antimicrobial therapy to achieve a successful outcome.

EP553 / #840

Topic: AS16. Others

“MY VOICE SOUNDS DIFFERENT”: A CASE OF ACUTE IDIOPATHIC VELOPHARYNGEAL INSUFFICIENCY

E-Posters

E-POSTER VIEWING

Rita Aldeia Da Silva^{1,2}, Inês Rua^{2,3}, Sandra Catarina Ferraz², Sandrina Martins², Helena Ramalho²
¹Hospital de Braga, Paediatrics, Braga, Portugal, ²Unidade Local de Saúde do Alto Minho, Paediatrics, Viana do Castelo, Portugal, ³Hospital Pediátrico de Coimbra, Paediatrics, Coimbra, Portugal

Title of Case: “MY VOICE SOUNDS DIFFERENT”: A CASE OF ACUTE IDIOPATHIC VELOPHARYNGEAL INSUFFICIENCY

Background: The velopharyngeal complex has an essential role in breathing, deglutition and speech. Velopharyngeal Insufficiency (VPI) results from impaired closure of the velopharyngeal port, related with congenital, acquired, iatrogenic or idiopathic conditions. Acute Idiopathic VPI is a rare entity that occurs usually in children and presents with rhinolalia and nasal regurgitation. Its cause is unknown but frequently associated with viral infections. Complete spontaneous recovery is the rule.

Case Presentation Summary: A previous healthy eight-year-old girl went to the emergency department due to sudden voice modification, noticed by herself and parents, that started 2 days before. Also referred fear of ingesting liquids after a previous episode of choking on water with nasal reflux. She had cough and rhinorrhea in the previous days, without fever. Physical examination showed unilateral velar paralysis with open rhinolalia during phonation, without other changes (remaining neurological exam included).

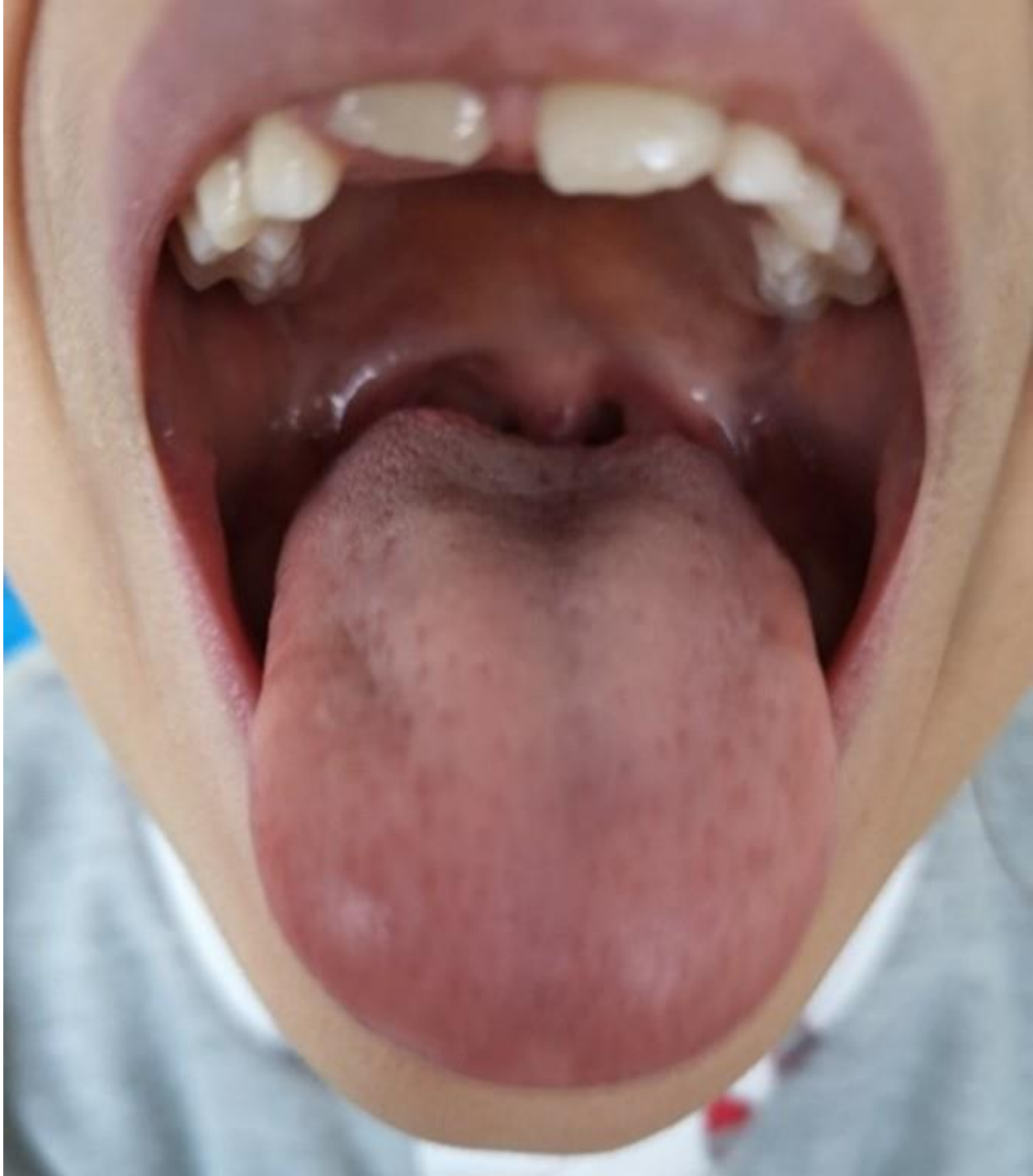

Fiberoptic nasopharyngoscopy was performed allowing characterization of the muscles involved. The cervical and brain computed tomography and the magnetic resonance imaging of the brain excluded any lesions. The respiratory panel and infectious serologies were negative. After a week without treatment and no recovery, she was treated with prednisolone for 5 days and was referred to speech therapy. On follow-up, the symptoms improved within 2 weeks and resolved completely in a month.

Learning Points/Discussion: The cause of acute isolated VPI remains unknown, but an infectious intercurrent can be associated. In this case a recent history of respiratory illness was reported. Other causes of VPI should be excluded before assuming idiopathic cause and follow-up is necessary to ensure

its benign nature. More reports and studies are necessary to further understand its pathology and clinical course.

EP554 / #1250

Topic: AS16. Others

CEFTRIAXONE-ASSOCIATED PSEUDOLITHIASIS IN AN ADOLESCENT WITH ABDOMINAL PAIN.

E-Posters

E-POSTER VIEWING

Ourania Alexandropoulou, Konstantinos Miliordos
General Hospital, Pediatrics, AGRINIO, Greece

Title of Case: Ceftriaxone-associated pseudolithiasis in an adolescent with abdominal pain.

Background: Cholelithiasis during childhood is an uncommon condition. Among its etiologies is ceftriaxone-related pseudolithiasis that is often neglected.

Case Presentation Summary: Case presentation: A 15-year old adolescent was admitted to a paediatric ward complaining of fever up to 39.5oC for 3 weeks and significant dysphagia. On admission he was febrile and had severe trouble opening his mouth due to trismus. Redness and swelling in the tonsillar area were observed, as well as multiple tender swollen lymph nodes, hot potato voice and severe odynophagia. No other pathology was identified. Laboratory data were the following: WBC:12.900/mm³ (ANC:10400), ESR:69 mm (1st hour), CRP: 17.4 mg/dl. An otorhinolaryngology evaluation diagnosed a unilateral peritonsillar abscess to the right and an incision and drainage of the pus were performed. The patient started receiving treatment with 80 mg/kg of ceftriaxone. On the fourth day of hospitalization the child complained of pain in the right upper part of the abdomen. An ultrasound detected gallstones of diameter>5 mm. Antibiotic therapy was changed to ampicillin-sulbactam and metronidazole. The symptoms subsided the next day. An abdominal ultrasound 21 days post hospitalization was performed that was normal and no gallstones were depicted.

Learning Points/Discussion: Learning points/Discussion: Ceftriaxone associated pseudolithiasis is not such a rare implication during treatment of infectious diseases and its diagnosis should not be neglected due to its asymptomatic or oligosymptomatic manifestation.

EP555 / #1523

Topic: AS16. Others

HEMATOLOGICAL PROFILE IN CHILDREN WITH COVID-19 PRESENTING IN A DISTRICT HOSPITAL.

E-Posters

E-POSTER VIEWING

Ourania Alexandropoulou¹, Sotiria Liapikou², Georgios Ntonas¹, Amalia Roulia², Konstantinos Miliordos², Simoni Gregoriou²

¹General Hospital, Pediatrics, AGRINIO, Greece, ²General Hospital, Pediatrics, AΓΓΙΝΙΟ, Greece

Backgrounds: Acquired cytopenia in previously healthy children is common in paediatric practice and usually appears during viral infections. Hematological changes in patients with SARS-CoV2 infection are common and include lymphopenia, leukopenia/neutropenia and occasionally thrombocytopenia. Aim The aim of this study was to assess the hematological profile among the febrile children with SARS-CoV2 infection who were examined in the emergency department of a district hospital. The molecular diagnosis has been by using RT-PCR from nasopharyngeal swabs.

Methods: Material–methods 229 febrile confirmed cases aged 4.0 ± 3.8 years (range 0-16) with RT-PCR test during a 1-year period were included. The molecular diagnosis has been by using RT-PCR from nasopharyngeal swabs.

Results: Among them 123/229 (53.7%) were boys and 106/229 (46.3%) were girls. The patients had a mean(\pm SD) age: 6.4 ± 3.9 yr .The mean \pm SD duration of fever was 3.4 ± 2.8 days. The highest prevalence of cases was observed during fall (116/229) (50.7%) and the lowest during summer (34/229) (14.8%). The majority of the cases had lymphopenia 170/229 (74.2%), 94/229(41%) had leukopenia and only 19 cases (8.3%) had neutropenia /leukopenia. There were no abnormalities in red blood cell count or level of hemoglobin. Only 1 case had mild thrombocytopenia. The cytopenia was transient and lasted for 3.3 ± 6.5 days.

Conclusions/Learning Points: Conclusion Hematological abnormalities are not rare in COVID-19 patients, may affect one or more cell lines.They are usually transient, without serious complications and resolve spontaneously.

EP558 / #1351

Topic: AS16. Others

PEDIATRIC HOSPITALIZATION FOR MILIARY TUBERCULOSIS IN BRAZIL: AN EPIDEMIOLOGICAL STUDY

E-Posters

E-POSTER VIEWING

Caio Augusto De Lima¹, Nathalia Caroline Teixeira Zana¹, Veronica Perius De Brito¹, João Victor Aguiar Moreira¹, Alessandra Akemi Cury Satokata¹, Marcos Vinicius Teixeira Martins¹, Douglas Alves Da Costa Canella², Artur Rodrigues Mazurek², Otavio Augusto Freire Campos¹, Mariângela De Lima Alves¹, Claudia Aparecida Botelho Carrijo¹, Monike Evelyn Da Silva¹, Sebastiana Silva Sabino¹, Luana Araújo Macedo Scalia¹, Tatianny Calegari¹

¹Federal University of Uberlândia, Faculty Of Medicine, Uberlandia, Brazil, ²Federal University of Grande Dourados, Faculty Of Medicine, Grande Dourados, Brazil

Backgrounds: Miliary tuberculosis is an important condition in pediatrics and leads its patients to present systemic clinical manifestations. Its diagnosis must be early, so that drug treatment proves to be effective.

Methods: Epidemiological study on national hospitalizations for miliary tuberculosis, between 2011 and 2020, carried out with data from the Sistema de Informações de Morbidade Hospitalar of the Ministry of Health of Brazil. Measures of central tendency, their confidence intervals and hypothesis tests were estimated to identify possible changes in the variables, considering a 5% significance level.

Results: An average of 26.80 (± 7.20) hospitalizations per year was recorded, of which 86.35% (± 3.88) occurred in an emergency regimen, with an average length of stay of 12.95 (± 1.75) days and a mortality rate of 3.69% (± 1.45). For the male population, 48.70% (± 2.35) of hospitalizations were found, with an average length of stay of 11.60 (± 0.92) days and a mortality rate of 4.55% (± 0.46). For the female group, there is a stay of 13.93 (± 0.54) days and a mortality of 2.88% (± 0.65). The highest rates of hospitalizations, 50.49% (± 6.25) of the total, and mortality, 3.88% (± 0.77), were observed for the brown population. By age group, there is a trend of increasing mortality with decreasing age (p -value=0.0347).

Conclusions/Learning Points: The miliary form of tuberculosis is responsible for urgent conditions that still lead to several pediatric hospitalizations in Brazil. The values presented here indicate the need for differentiated health strategies for the brown and younger population. In addition, the higher male mortality, accompanied by shorter lengths of stay in the services, may signal the possible need to review the national care protocols for this disease.

EP559 / #1477

Topic: AS16. Others

EPIDEMIOLOGY OF PEDIATRIC SCHISTOSOMIASIS IN THE STATE OF MINAS GERAIS - BRAZIL

E-Posters

E-POSTER VIEWING

Caio Augusto De Lima¹, Otavio Augusto Freire Campos¹, Monike Evelyn Da Silva¹, Artur Rodrigues Mazurek², Douglas Alves Da Costa Canella², João Victor Aguiar Moreira¹, Marcos Vinicius Teixeira Martins¹, Nathalia Caroline Teixeira Zana¹, Alessandra Akemi Cury Satokata¹, Veronica Perius De Brito¹, Tatiany Calegari¹

¹Federal University of Uberlândia, Faculty Of Medicine, Uberlandia, Brazil, ²Federal University of Grande Dourados, Faculty Of Medicine, Grande Dourados, Brazil

Backgrounds: Schistosomiasis is a parasitic disease caused by the parasite *Schistosoma mansoni* when it comes into contact with snails in freshwater reservoirs infected by the worms, being a public health problem related to lack of basic sanitation and sanitary issues that can lead to infant mortality if they do not have it. the proper treatment.

Methods: Epidemiological study on schistosomiasis in the state of Minas Gerais - Brazil, between 2007 and 2017, with patients aged between 0 and 14 years, carried out with data from the Hospital Morbidity Information System of the Ministry of Health of Brazil.

Results: Between 2007 and 2017, there were 14039 cases, with an increase in patients younger than 1 year (593), 1-4 years (853), 5-9 years (4137), 10-14 (8456), with great concentration of cases in the years between 2009 (2775) and 2010 (5123), with a predominance of 8539 males and 5499 females. Among races, 8581 cases were black/brown people, 2650 were white people and 2424 were unresponsive. During the period, clinical evolution was ignored in 5252 cases, 8714 resulted in cure, 71 were not cured and one death due to schistosomiasis .

Conclusions/Learning Points: The data show that even with the large number of children acquiring schistosomiasis, identification and treatment are easily accessible through free public policies by the Unified Health System - SUS that provide adequate treatment, the same system demonstrates advances in basic sanitation, the main risk factor for acquiring the disease. The state of Minas Gerais is one of the most developed in Brazil, due to its large territorial extension, it has regions where income inequalities, social and racial factors are still vulnerability factors for the population.

EP560 / #74

Topic: AS16. Others

MULTIDRUG RESISTANT SHIGELLA FLEXNERI : A RARE CASE OF SEPTIC SHOCK IN A 5 YEAR OLD CHILD

E-Posters

E-POSTER VIEWING

Deepak Bhat, Gurdeep Singh Dhooria

Dayanand Medical College and Hospital, Pediatrics, Ludhiana, India

Title of Case: Multidrug Resistant Shigella Flexneri : A Rare Case of Septic Shock In A 5 year old child

Background: Shigellosis is primarily caused by *S. dysenteriae*, *S. flexneri*, *S. boydii*, and *S. sonnei*. *S. dysenteriae* type 1 and *S. flexneri* are among the most virulent serotypes, associated with invasive shigellosis leading to septicemia. . Risk factors for developing septicemia in shigellosis include young age, malnutrition and immune-suppression.

Case Presentation Summary: Shigellosis is still an important public health problem in developing and under-developed countries. It may lead to rare but potentially fatal various extra intestinal complications like septicemia, shock, involvement of CNS, urinary tract and liver especially in young malnourished children. *Shigella dysenteriae* type 1 and *Shigella flexneri* are among the most toxic of serotypes associated with septicemia. There is increasing infection with multi drug resistant strains. Herein we report a 5 year old child who came to our emergency department as a case of acute dysentery with shock and his stool and blood culture both grew multidrug resistant shigella flexneri.

Learning Points/Discussion: *Shigella* infection should be kept as a differential diagnosis when a patient with severe sepsis associated with diarrhoea and vomiting is encountered. Antibiotic susceptibility profile of the isolate has to be kept in mind while treating such patients especially when the patient do not respond even after 48 hours of empirical antibiotic treatment, which could be life saving.

EP561 / #1018

Topic: AS16. Others

WHAT COULD CAUSE AN EXTENSIVE ALOPECIA IN CHILDREN?

E-Posters

E-POSTER VIEWING

Joana Capela, Mariana Reis, Inês Almeida, Márcio Moura, Maria Virtuoso
Centro Hospitalar Universitário do Algarve, Serviço De Pediatria, Faro, Portugal

Title of Case: What could cause an extensive alopecia in children?

Background: Tinea capitis (TC) is a scalp infection caused by the Tricophyton and Microsporum genera fungi, frequent between three and seven years of age. Stray cats and dogs are the main source of contagion. Kerion is a deep infection, with painful plaque on the scalp and purulent exudate, caused by zoophilic dermatophytes. The diagnosis is clinical, achieved with the help of dermoscopy, tricoscopy, laboratory tests and mycological cultural examination. The mainstay of treatment consists of systemic and topical antifungals. Scarring alopecia results from a massive inflammatory response, or delay in treatment.

Case Presentation Summary: We report a case of a seven-year-old boy, who went to the emergency department with a painful plaque and purulent exudate on the scalp, for the last two months. The child also reported itching and denied fever. He had regular contact with a domestic dog and stray cats. He had extensive alopecia, pustules, meliceric scabs, purulent exudation and fluctuation of the occipital scalp, with posterior cervical satellite adenopathies. Analytically we found leukocytosis, neutrophilia, thrombocytosis and increased CRP. A diagnosis of Kerion with bacterial superinfection was thus assumed. Scale and hair samples were collected for direct and cultural examination. Empirical treatment was started with terbinafine, shampoo and antifungal spray, systemic and topical antibiotics and prednisolone, with a favorable clinical evolution, despite maintaining cicatricial alopecia after four weeks of antifungal agents.

Learning Points/Discussion: This case highlights the importance on early diagnosis and intervention in cases of TC, specifically Kerion, since it has an adequate response to treatment, if started early. Late diagnosis can lead to alopecia and irreversible scars, which may result in a high psychological and social impact for these children.

EP562 / #1532

Topic: AS16. Others

TETANUS IN PREVIOUSLY VACCINATED SCHOOL-AGED CHILDREN IN AFRICA. SHOULD WE RECONSIDER THE VACCINE SCHEDULE?

E-Posters

E-POSTER VIEWING

Carolina Castro¹, Ana Cristóvão Ferreira¹, Isabel Coelho², Joana Glória¹, Swasilanne Bandeira³, José Gonçalo Marques⁴

¹Hospital de Santa Maria - Centro Hospitalar Universitário Lisboa Norte, Serviço De Pediatria Médica, Departamento De Pediatria, Lisboa, Portugal, ²Hospital Espírito Santo de Évora, Serviço De Pediatria, Évora, Portugal, ³Hospital Ayres de Menezes, Serviço De Pediatria, São Tomé, Sao Tome and Principe, ⁴Hospital de Santa Maria - Centro Hospitalar Universitário Lisboa Norte, Unidade De Infeciologia E Imunodeficiências - Departamento De Pediatria, Portugal, Portugal

Title of Case: TETANUS IN PREVIOUSLY VACCINATED SCHOOL-AGED CHILDREN IN AFRICA. SHOULD WE RECONSIDER THE VACCINE SCHEDULE?

Background: Tetanus is an acute, toxin-mediated disease caused by *Clostridium tetani*. It occurs more frequently in warmer climates and during warmer months. Widespread vaccination has dramatically reduced this disease's incidence, particularly in high-income countries. Furthermore, access to healthcare and the treatment availability may be determinant to the prognostic of the disease.

Case Presentation Summary: We review a case series of three patients with tetanus in a low-income western African country. All had completed the implemented vaccine scheme of a 3-dose primary series (at 6, 10 and 14 weeks-of-life). The milder case was in an 8-year-old boy who received proper wound management and a booster vaccination when he got injured. A second moderate case was seen in a 5-year-old boy with no index wound who got a booster dose at diagnosis, when he presented with generalised muscle spasms and risus sardonicus. The most severe case was observed in a 9-year-old girl whose wound was stitched. She didn't receive a booster tetanus vaccine nor antibiotic treatment. She later presented with gait disturbance, generalised muscle contraction, trismus and opisthotonos. All patients were managed conservatively with antibiotics and muscle relaxants, with no human tetanus immunoglobulin available. The patients had long hospital stays, but all recovered.

Learning Points/Discussion: Tetanus is a potentially lethal disease, mainly in low-income countries. Proper wound management could effectively change the disease course, but vaccination is key, specially in countries where prompt wound care may not be easily accessible. This case series reinforces the question of the durability of protection conferred by a 3-dose vaccination schedule against tetanus that ends before 4-months-old and supports the implementation of two booster doses in preschool children.

EP563 / #530

Topic: AS16. Others

ABDOMINAL PAIN IN ADOLESCENCE - WHAT DOES IT HIDE?

E-Posters

E-POSTER VIEWING

André Costa Azevedo, Cátia Silva, Sofia Miranda, Sandrina Martins, Isabel Martinho, Francisca Martins
Unidade Local de Saúde do Alto Minho, Paediatrics, Viana do Castelo, Portugal

Title of Case: ABDOMINAL PAIN IN ADOLESCENCE - WHAT DOES IT HIDE?

Background: The majority of episodes of abdominal pain in paediatric age are benign but more serious underlying diseases may be considered. Pyogenic liver abscesses are an uncommon yet potentially life-threatening cause of abdominal pain in children. Staphylococcus aureus is the most common pathogen followed by Escherichia coli and Klebsiella species. Typical clinical manifestations are fever and abdominal pain, but other nonspecific findings may be present.

Case Presentation Summary: A 13-year-old boy was asymptomatic 2 weeks prior to presentation when he developed diarrhoea, vomiting and fever, and was diagnosed with acute gastroenteritis. These symptoms resolved, but after one week fever recurred associated to right upper quadrant abdominal pain and his clinical course worsened with progressive anorexia, asthenia and 5 kilograms' weight loss. On physical examination, patient was pale and had abdominal tenderness on palpation, mainly on right quadrants. Laboratory tests revealed neutrophilic leucocytosis, elevated value of C-reactive protein and elevated serum levels of aminotransferases and lactate dehydrogenase. Abdominal computerized tomography (CT) revealed a large collection in the right hepatic lobe suggesting a subcapsular liver abscess. He was started on intravenous antibiotics and a CT-guided percutaneous drainage was performed. Stool Entamoeba histolytica antigen was negative and Escherichia coli was identified from the drained abscess fluid. An immunological study and colonoscopy were performed, which were normal.



Learning Points/Discussion: Although more common in developing countries, liver abscesses should be considered in differential diagnoses in children presenting with unspecific symptoms such as fever and abdominal pain. Most of liver abscesses are cryptogenic, however underlying conditions, including immunodeficiencies should be excluded. Intravenous antibiotics and percutaneous drainage are the standard treatment for hepatic abscesses and should be initiated in order to reduce mortality rate.

EP565 / #695

Topic: AS16. Others

ANEMIA AND HUMAN PARVOVIRUS B19 INFECTION – NOT ALWAYS APLASTIC ANEMIA

E-Posters

E-POSTER VIEWING

Mariana Eiras Dias, Inês Silva, Rita Barreira

Centro Hospitalar Lisboa Ocidental - Hospital São Francisco Xavier, Paediatrics, Lisboa, Portugal

Title of Case: ANEMIA AND HUMAN PARVOVIRUS B19 INFECTION – NOT ALWAYS APLASTIC ANEMIA

Background: Human parvovirus B19 (HPV-B19) causes transient aplastic crises in immunocompromised individuals. HPV-B19 has rarely been implicated as a cause of autoimmune hemolytic anemia (AIHA) in healthy children. This is a case report of an immunocompetent child presenting AIHA secondary to HPV-B19.

Case Presentation Summary: A 8-year-old boy presented with pallor, asthenia and orange urine over a period of 4 days which was preceded of 4 days of vomiting, diarrhea and fever. At observation he had generalized paleness with jaundice of the sclera and a systolic murmur. Blood analysis revealed a regenerative (reticulocytes of 15.6 %) normocytic anemia (hemoglobin of 4,6 g/dL) without other cytopenias. The peripheral blood smear showed some spherocytes. Further blood tests showed laboratory evidence of hemolysis with positive direct Coombs emphasizing that we were facing a case of an autoimmune hemolytic anemia. During hospitalization, multiple blood transfusions were required and corticosteroid therapy was started. Broaden complementary diagnostic exams demonstrated positivity for IgM and IgG of HPV-B19. He was discharged after 10 days with a hemoglobin (Hb) of 8,6 g/dL under prednisolone (PDN) 1.5 mg/kg/day and was followed up in the Pediatrics and Hematology consultation. He is currently followed in the consultation and stopped PDN seven months after hospital discharge with an increase in Hb parameters within normal limits and absence of clinical complaints.

Learning Points/Discussion: This case emphasizes the importance of clinical suspicion of HPV-B19 infection even in immunocompetent children in an episode of AIHA. In this case, the anemia could be due to a double mechanism: on one hand, the formation of antibodies directed against red blood cells and on the other hand erythroblastopenia related to HPV-B19.

EP566 / #1432

Topic: AS16. Others

NONTYPHOIDAL SALMONELLA INFECTIONS IN A LEVEL II PORTUGUESE HOSPITAL – A 10 YEARS RETROSPECTIVE STUDY

E-Posters

E-POSTER VIEWING

Ana Sofia Figueiredo, Carolina Quintela, Sandra Pereira, Joana Carvalho
Centro Hospitalar de Trás os Montes e Alto Douro, Paediatrics, Vila Real, Portugal

Backgrounds: Nontyphoidal salmonella infect small intestinal epithelial cells causing gastroenteritis.

Methods: To study infections severity and prevalence from 2012 to 2021, we performed a retrospective descriptive analyses and correlation tests using SPSS.

Results: We report 60 salmonella infections, 59 gastroenteritis and 1 extraintestinal disease (bacteriemia). The number of fecal microbiology analysis substantially increased since 2012, nonetheless the positive percentage was stable along the years (4-8%). Patients median age was 4.9 years. Most occurred in summer (60%) and an epidemiological link was found in 27%. The majority had diarrhea (93%) and fever (80%) and almost half reported vomiting (52%), fecal blood (53%) and abdominal pain (45%). Salmonella species serotype was identified in 10 patients, five enteritidis, three 4,5:i, one typhimurium and one choleraesuis. Intravenous fluid therapy was administered in 27 (45%).

Hospitalizations (n=16) were due to dehydration (6), age (4), persistent vomiting (3), acute kidney injury (2) and bacteremia (1). No difference was found between hospitalized and non-hospitalized children median age (p=0,146). Antibiotic treatment was completed in 8 (13%) with third-generation cephalosporins, but only 3 fulfilled ESPHGAN criteria. Bacterial intestinal coinfection with *Campylobacter* and *Escherichia coli* was found in 2 patients and 3 had other complications, including acute kidney injury and hypocalcemia. Complications were not associated with other relevant diseases or younger age.

Conclusions/Learning Points: Only 27% had epidemiological risk factors which may difficult the identification of pathogen source. Fecal blood reported is lower than described in the literature, maybe due to early or isolated evaluations during disease course. Five patients were treated with antibiotics despite recommendations, which should be avoided since it doesn't shorten disease course and may prolong bacterial shedding. It is important to revise antibiotics use to improve patients care.

EP568 / #1261

Topic: AS16. Others

DETECTION IN AN ORPHANAGE OF COMMUNITY-ACQUIRED METHICILLIN-RESISTANT STAPHYLOCOCCUS AUREUS.

E-Posters

E-POSTER VIEWING

Samuel Gonzalez-Garcia¹, Aida Hamdan-Partida², Rubén Del Muro-Delgado³, Anaid Bustos-Hamdan⁴, Jaime Bustos-Martínez²

¹Universidad Autónoma Metropolitana, Doctorado En Ciencias Biológicas Y De La Salud, Mexico City, Mexico, ²Universidad Autónoma Metropolitana Unidad Xochimilco, Atención A La Salud, Mexico City, Mexico, ³Universidad Autónoma Metropolitana, Sistemas Biológicos, Mexico City, Mexico, ⁴Hospital Infantil de México "Federico Gómez", None, Mexico City, Mexico

Backgrounds: Staphylococcus aureus is a pathogenic bacterium that is associated with various diseases both in hospitals and in the community. Between 20% and 35% of the adult population are carriers of this microorganism in the nasal vestibule, but can also be found in the pharynx of people. The MRSA strains had manifested primarily in hospitals, but in recent years have appeared in community outbreaks in healthy children and adults, with no history of hospitalization. These strains were called community-acquired methicillin-resistant Staphylococcus aureus (CA-MRSA). The objective of this work was to detect the presence of strains CA-MRSA in an orphanage in Mexico City.

Methods: Pharyngeal and nasal swabs of 80 people between 3 and 19 years old of both genders were taken. We identified S. aureus by microbiological methods. The mecA and Panton-Valentine leukocidin (PVL) genes were detected by PCR. The SCCmec type and spa-type were determined.

Results: 56% of the population had S. aureus; 12.5% only in the pharynx, 17.5% only in the nose and 26% at both sites. We detected only four MRSA strains (5%), one in the pharynx and three in the nose, which presented the mecA, the PVL genes, and have the SCCmec type IV, so they are CA-MRSA strains.

Conclusions/Learning Points: The results show that there are CA-MRSA strains in healthy children and adolescents in an orphanage in Mexico City.

EP569 / #1277

Topic: AS16. Others

COLONIZATION OF STAPHYLOCOCCUS AUREUS AND STAPHYLOCOCCUS EPIDERMIDIS IN CHILDREN AND ADOLESCENTS OF MEXICO CITY.

E-Posters

E-POSTER VIEWING

Samuel Gonzalez-Garcia¹, Aida Hamdan-Partida², Miguel Ángel Zavala-Sánchez³, Anaid Bustos-Hamdan⁴, Jaime Bustos-Martínez²

¹Universidad Autónoma Metropolitana, Doctorado En Ciencias Biológicas Y De La Salud, Mexico City, Mexico, ²Universidad Autónoma Metropolitana Unidad Xochimilco, Atención A La Salud, Mexico City, Mexico, ³Universidad Autónoma Metropolitana, Sistemas Biológicos, Mexico City, Mexico, ⁴Hospital Infantil de México "Federico Gómez", None, Mexico City, Mexico

Backgrounds: Staphylococcus aureus is a Gram-positive bacterium, it is an opportunistic and potentially lethal pathogen of great clinical importance due to the different virulence. In recent years, S. epidermidis has acquired great relevance because it has become an important opportunistic pathogen. The objective of the work was to determine the pharyngeal and nasal colonization of S. aureus and S. epidermidis in children and adolescents from Mexico City.

Methods: 477 pharyngeal and nasal swabs were performed in pediatric patients under 16 years of age between 2013 and 2019, the swabs were stored in trypticasein soy broth, inoculated on mannitol salt agar and incubated for 24 hours at 37 ° C. The presence of S. aureus and S. epidermidis was determined by mannitol fermentation and positivity to the coagulase test or by sequencing of the 16S rRNA gene.

Results: A total of 240 women (50.42%) and 237 men (49.58%) (N = 476) with an average age of 7.39 years (+/- 2.76) were studied, finding 68.49% of S. aureus carriers, regardless of gender and the isolation site, in which 207 (43.48%) strains of S. aureus isolated were found in the nose and 225 (47.26%) in the pharynx, while 141 (29.62%) strains of S. epidermidis were found in the nose and only 70 (14.7%) in the pharynx, 35 strains of other staphylococci (Staphylococcus spp) (7.35%) were isolated in the nose and 46 (9.66%).

Conclusions/Learning Points: A high percentage of carriers was found in the pharynx, compared to the nose, which is consistent with investigations that study the nose and pharynx in parallel, and more S. aureus than S. epidermidis were also isolated in both sites and in a larger percentage to other staphylococci.

EP570 / #1356

Topic: AS16. Others

PRESENCE IN A NURSERY OF COMMUNITY-ACQUIRED METHICILLIN-RESISTANT STAPHYLOCOCCUS AUREUS

E-Posters

E-POSTER VIEWING

Samuel Gonzalez-Garcia¹, Aida Hamdan-Partida², María Teresa Nuñez-Cardona³, Anaid Bustos-Hamdan⁴, Jaime Bustos-Martínez²

¹Universidad Autónoma Metropolitana, Doctorado En Ciencias Biológicas Y De La Salud, Mexico City, Mexico, ²Universidad Autónoma Metropolitana Unidad Xochimilco, Atención A La Salud, Mexico City, Mexico, ³Universidad Autónoma Metropolitana, El Hombre Y Su Ambiente, Mexico City, Mexico, ⁴Hospital Infantil de México "Federico Gómez", None, Mexico City, Mexico

Backgrounds: Staphylococcus aureus is a microorganism of great medical importance. For many years it has been recognized as one of the major pathogens for humans. Infections with methicillin-resistant S. aureus (MRSA), are usually acquired in hospitals (strains HA-MRSA). However, in the late 90's, MRSA strains emerged in healthy adults and children in communities. These strains cause infections in the community. The prevalence of these infections has increased significantly in recent years. Strains of S. aureus that cause these infections are called strains MRSA community-acquired (CA-MRSA). The aim of this work was to make the identification and molecular characterization of strains of Staphylococcus aureus isolated in a daycare of Mexico City.

Methods: Throat swabs samples from 87 children, between 2 and 6 years old were taken. S. aureus was identified by microbiological methods. The mecA and Panton-Valentine leukocidin (PVL) genes were detected by PCR. The SCCmec type and spa-type were determined.

Results: 25% of the population had S. aureus in the throat. From the strains isolated, we found that 22% (five strains) were MRSA, of which only one present the mecA gene, the gene of PVL and SCCmec type IV, therefore we found a CA-MRSA strain.

Conclusions/Learning Points: The results show there may be strains CA-MRSA in healthy carriers in Mexico City, so strains CA-MRSA are present circulating in the community.

EP571 / #1141

Topic: AS16. Others

ANALYSIS OF BIOFILM-PRODUCING ABILITY IN STRAINS DERIVED FROM INVASIVE NON-TYPEABLE HAEMOPHILUS INFLUENZAE INFECTIONS

E-Posters

E-POSTER VIEWING

Kenji Gotoh¹, Saho Shima², Atsushi Miyake¹, Yuhei Tanaka³, Naruhiko Ishiwada⁴, Hiroshi Watanabe¹
¹Kurume University School of Medicine, The Department Of Infection Control And Prevention, Kurume, Japan, ²Kurume University School of Medicine, Pediatrics And Child Health, Kurume-city, Fukuoka, Japan, ³Kurume University of Medicine, The Department Of Pediatrics And Child Health, Kurume City, Japan, ⁴Chiba University, Division Of Infection Control And Prevention, Chiba, Japan

Backgrounds: After the introduction of the Hib vaccination, the number of serious infections caused by Hib has decreased dramatically, but the incidence of infections caused by non-typeable Haemophilus influenzae (NTHi) is on the rise. In particular, invasive NTHi infections have been reported, and biofilm production has attracted attention as a factor on the bacterial side that can lead to invasive infections. We evaluated the biofilm-producing ability of isolated from neonatal meningitis and sterile specimens from children.

Methods: The cap gene and the bex gene were used to identify the NTHi. These isolates were performed MLST analysis. We performed the plate assay method and the flow cell chamber method to evaluate the biofilm production ability of two neonatal meningitis isolates, five pediatric invasive infectious disease isolates. In the flow cell chamber method, the cells were stained with LIVE/DEAD and DRAQ5 and observed under a confocal microscope.

Results: In MLST analysis, the same sequence type was not observed in the isolates. In the plate assay, both strains from neonates showed low biofilm production ability, while the strains from invasive pediatric infections showed high biofilm production ability. In addition, confocal microscopy showed that the strains of invasive pediatric infections had many viable bacteria in the biofilm, and the surface was covered with extracellular DNA, forming a thick slim.

Conclusions/Learning Points: Biofilm production does not appear to be relevant to the pathogenicity of NTHi isolated from neonates. On the other hand, biofilms are thought to have an effect on the strains that caused invasive infections in children. Based on the confocal microscopy results, extracellular DNA is likely to be an important element, and the expression analysis of thermo-nucleases is necessary.

EP572 / #1254

Topic: AS16. Others

FEVER WITHOUT A SOURCE IN CHILDREN: INTERNATIONAL COMPARISON OF GUIDELINES.

E-Posters

E-POSTER VIEWING

Sanne Graaf¹, Maya Keuning², Frans Plötz^{1,2}, Dasja Pajkrt³

¹Tergooi Hospital, Paediatrics, Blaricum, Netherlands, ²Emma Children's Hospital, Amsterdam University Medical Centre, Paediatrics, Amsterdam, Netherlands, ³Amsterdam University Medical Centre, Pediatric Infectious Diseases, Amsterdam, Netherlands

Backgrounds: Fever without a source (FWS) in children poses a diagnostic challenge. To distinguish a self-limiting infection from a serious infection, multiple guidelines have been developed to aid physicians in the management of FWS. Currently, there is no comparison of existing FWS guidelines.

Methods: This comparative review describes consistencies and differences in guideline definitions and diagnostic and therapeutic recommendations. A literature search was performed to include secondary care FWS guidelines of high-income countries, composed by national or regional pediatric or emergency care associations, available in English or Dutch.

Results: Ten guidelines of five high-income countries were included, with varying age ranges of children with FWS. In children younger than one month with FWS, the majority of the guidelines recommended laboratory testing, blood and urine culturing and antibiotic treatment irrespective of the clinical condition of the patient. Recommendations for blood culture and antibiotic treatment varied for children aged one to three months. In children aged above three months, urine culture recommendations were inconsistent while all guidelines consistently recommended cerebral spinal fluid testing and antibiotic treatment exclusively for children with a high risk of serious infection.

Conclusions/Learning Points: We found these guidelines broadly consistent, especially for children with FWS younger than one month. Guideline variation was seen most in the targeted age ranges and in recommendations for children aged one to three months and above three months of age. The findings of the current study can assist in harmonizing guideline development and future research for the management of children with FWS.

EP573 / #1515

Topic: AS16. Others

TWO CASES OF CUTANEOUS LEISHMANIASIS IN ARMENIA

E-Posters

E-POSTER VIEWING

Benik Mkhitarian¹, Mark Grigoryan¹, Sose Margaryan², Tatevik Grigoryan², Violeta Manukyan², Gevorg Baklachyan¹, Hasmik Hakobyan², Suren Brutyan², Lernik Martirosyan², Vigen Asoyan³, Hripsime Apresyan⁴

¹Yerevan State Medical University, Military Medicine, Yerevan, Armenia, ²"MURATSAN" HOSPITAL COMPLEX (YEREVAN STATE MEDICAL UNIVERSITY NAMED AFTER MKHITAR HERATSI), Isolation Unit, Yerevan, Armenia, ³Yerevan State Medical University, Infectious Diseases, Yerevan, Armenia, ⁴Yerevan State Medical University, Pediatric Infectious Diseases, Yerevan, Armenia

Title of Case: Two Cases of Cutaneous Leishmaniasis in Armenia

Background: More than 90% of Cutaneous Leishmaniasis cases occur in the Mediterranean basin, the Americas, the Middle East and Central Asia. Although Cutaneous Leishmaniasis is the most common form of leishmaniasis. In Armenia Visceral Leishmaniasis occur frequently than other forms. Armenia is endemic region for this disease, although most cases are imported.

Case Presentation Summary: Case 1: A 10-year-old girl was admitted to Muratsan University Hospital with papular lesion of nose, which persisted for about 6-7 months. Vital signs were normal. Physical examination showed 0.6x0.6cm papule with distinct borders on the tip of nose. The lesion was hyperemic and non-mobile, non-tender during palpation. After surgical removal microscopic analysis of tissue samples discovered granulomas with non-necrotic center surrounded predominantly with histiocytes, lymphocytes and low plasmatic cells typical for Leishmaniasis, and Leishmania parasites. Intramuscular Meglumium Antimoniate was preferred intralesional injection out of papule location (14 days). Case 2: A previously healthy one-year-old boy was presented to Muratsan University Hospital. Physical examination showed 2.5x3cm lesions surrounded by hyperemic and swollen rim on right cheek and forehead skin. A papule appeared on cheek 4 months ago then gradually became an ulcer. After 2 months the same was noticed on forehead. Before admission topical antibacterial drugs were used with no positive effect. Rapid antigen test - negative, microscopic examination - Leishmania parasites. She was treated with intralesional injection of Meglumium Antimoniate (14 days).

Learning Points/Discussion: Parasitic infections such as Leishmaniasis seems to be neglected as a cause of skin infection such described in these patients. As the definitive diagnosis of CL is made by microscopic examples or PCR test and negative predictive value of rapid tests is low (negative result cannot exclude CL), it is highly recommended to recognize clinical presentations of CL.

EP574 / #1482

Topic: AS16. Others

CANDIDA GUILLIERMONDII IN A PATIENT WITH WILMS TUMOR AFTER TREATMENT WITH DEXAMETHASONE DUE TO CANCER HEMOPHAGOCYTOSIS

E-Posters

E-POSTER VIEWING

Lambrini Damianidou¹, Vasiliki Antari¹, Georgios Totikidis², Maria Lamprou², Kiriaki Kotsoglanidou², Eleni Papadimitriou³, [Elias Iosifidis](#)⁴, Emmanuel Roilides⁴, Evgenia Papakonstantinou²

¹Ippokratio Hospital of Thessaloniki, Paediatric Oncology Department, Thessaloniki, Greece, ²Hippokraton Hospital of Thessaloniki, Pediatric Oncology Department, Thessaloniki, Greece, ³Aristotle University of Thessaloniki, 1st Department Of Pediatrics, Thessaloniki, Greece, ⁴Aristotle University of Thessaloniki, Infectious Diseases Unit, 3rd Pediatric Department, Thessaloniki, Greece

Title of Case: CANDIDA GUILLIERMONDII IN A PATIENT WITH WILMS TUMOR AFTER TREATMENT WITH DEXAMETHASONE DUE TO CANCER HEMOPHAGOCYTOSIS

Background: To describe a non-Candida albicans fungemia in a cancer patient treated for Hemophagocytic lymphohistiocytosis (HLH). Candida Guilliermondii is part of the normal fungal microbiota of human skin and mucosa. It is a rare cause of invasive candidiasis in cancer patients, particularly those with hematological malignancies. There is limited literature and only few cases have been reported worldwide, especially in pediatric population.

Case Presentation Summary: A two-year-old female patient with Wilms Tumor was hospitalized with fever (38 °C) after 6 weeks of successful treatment of HLH with dexamethasone. Laboratory tests results included leukocytosis 15,6 K/ μ L (3,8 – 10,5 K/ μ L) with 82% neutrophils, 11,8% lymphocytes, normal rates of hemoglobin concentration and platelet count and substantially elevated C-reactive protein level (59,4mg/L, normal rate \leq 6mg/L). C. Guilliermondii was isolated from the central vein catheter (CVC) blood culture. CVC was replaced and intravenous (IV) antifungals therapy (micafungin 2mg/kg per day) was administered for ten days. She became afebrile the next day, whereas blood culture from CVC was negative on third day of treatment. The child was stable and afebrile during the whole hospitalization.

Learning Points/Discussion: Recognizing non-albicans Candida species as clinically relevant pathogens is important due to its decreased susceptibility to antifungal agents. C. guilliermondii poses a threat in the hospital setting, particularly in cancer patients, immunocompromised and patient with indwelling CVC.

EP577 / #1592

Topic: AS16. Others

ENTEROCOCCAL BACTEREMIA IN CHILDREN: AN 11-YEAR CLINICAL EXPERIENCE WITH 64 PATIENTS

E-Posters

E-POSTER VIEWING

Kyo Jin Jo¹, Su Eun Park²

¹Pusan National University Children's Hospital, Pediatrics, Yangsan-si, Gyeongsangnam-do, Korea, Republic of, ²Pusan National University Children's Hospital, Pediatrics, Yangsan, Korea, Republic of

Backgrounds: We aimed to describe the epidemiology and clinical and laboratory characteristics of enterococcal bacteremia in Korean children.

Methods: We retrospectively reviewed the medical records of children who were defined as the isolation of enterococci from blood cultures in Pusan National University Children's Hospital during December 2009 to November 2019.

Results: Overall, 64 patients were enrolled during the study period. 43 (67.2%) patients were male, and the median age was 0 year (range 0-15). *Enterococcus faecalis* (50%) was the most common defined strain, followed by *Enterococcus faecium* (45.3%), *Enterococcus avium* (3.1%), and *Enterococcus hirae* (1.6%). Significant underlying diseases were present in 60 (93.8%) patients, including prematurity (34.4%), cardiac disease (18.8%), gastrointestinal disorder (10.9%), and hematologic malignancy (7.8%). 56 (87.5%) patients had received previously broad-spectrum antibiotics. 54 (84.4%) patients were nosocomial in origin, and 16 (25%) patients were polymicrobial bacteremia. The source of bacteremia was identified in 36 (56.3%) patients. Among them, intravascular device being the most common identifiable source. 29 (45.3%) strains were resistant to ampicillin and 16 (25%) strains were resistant to vancomycin. There was no strain resistant to linezolid. After appropriate antibiotic treatment, 5 (7.8%) patients recurred enterococcal bacteremia and 7 (10.9%) patients were diagnosed with bacteremia defined other pathogen from blood culture. The mortality rate was 7.8%. Comparing patients who were defined enterococcal bacteremia resistant to vancomycin with those who did not, there were no significant differences in patients' age and sex ($P=0.118$, $P=0.516$). Mortality rate was significantly higher in patients who were defined enterococcal bacteremia resistant to vancomycin ($P=0.022$).

Conclusions/Learning Points: Enterococcal bacteremia in children was usually nosocomial and occurred in children with serious underlying diseases.

EP579 / #704

Topic: AS16. Others

THE CHANGING NATURE OF PAEDIATRIC INFECTIOUS DISEASES CONSULTATIONS OVER THE SARS-COV-2 PANDEMIC

E-Posters

E-POSTER VIEWING

Alison Kent¹, Harsita Patel², Eleni Papachatzi¹, Hermione Lyall¹, Elizabeth Whittaker¹

¹Imperial Healthcare NHS Trust, Paediatric Infectious Diseases, London, United Kingdom, ²Imperial College London, Infectious Disease, London, United Kingdom

Backgrounds: Paediatric infectious disease (PID) services have played a leading role in the COVID-19 pandemic. PID leadership has been essential for the management of novel conditions such as paediatric COVID-19 pneumonitis and multisystem inflammatory syndrome in children (MIS-C). With limited evidence-based treatment options, the management of these critically ill children remains challenging. We describe the changing nature of referrals to a specialist PID service from local network hospitals, during the COVID-19 pandemic.

Methods: All PID consultations to our service are recorded for clinical governance purposes. As part of service evaluation, anonymised data from referrals between 01/01/2019 - 31/12/21 was analysed retrospectively. This included patients' location, age, clinical condition, comorbidities, differential diagnoses, outcome and PID input.

Results: Over the 3-year study period a total of 1581 referrals were made from 54 institutions. The majority of referrals regarded inpatients in other hospitals (94%) with a range of clinical conditions (table 1). There was an annual increase in the number of referrals (54% increase 2019-2020, 25% increase 2020-2021) and number of patients transferred to a specialist centre over the study period (9.4% to 17.2%, 183% increase). This correlated with an increase in consultations regarding patients with MIS-C and acute COVID-19. However, even excluding these SARS-CoV-2 related conditions, referrals over the study period increased (29% increase 2019-2020, 2% increase 2020-2021).

Conclusions/Learning Points: SARS-CoV-2 related conditions have led to an increase in referrals and transfers to our specialist PID service. However, referrals for other conditions have also increased compared to the pre-COVID-19 era. This may reflect increasing diagnostic uncertainty and / or more awareness of PID services. This data will be used for workforce planning and outreach training in 2022.

EP580 / #380

Topic: AS16. Others

EVALUATION OF PEDIATRIC CASES WITH SUSPECTED RABIES EXPOSURE IN THE PEDIATRIC EMERGENCY DEPARTMENT

E-Posters

E-POSTER VIEWING

Yalçın Kara¹, Mahmut Kizil¹, Merve İşeri Nepesov¹, Ömer Kılıç², Sabiha Şahin³, Ener Cagri Dinleyici⁴
¹Eskişehir Osmangazi University, Pediatric Infectious, Eskişehir, Turkey, ²Eskişehir Osmangazi Medical University, Pediatric Infectious, Eskişehir, Turkey, ³Eskişehir Osmangazi Medical University, Pediatric Emergency Care, Eskişehir, Turkey, ⁴Eskişehir Osmangazi Medical University, Pediatric Intensive Care, Eskişehir, Turkey

Backgrounds: Rabies is a public health problem that can be prevented by vaccination and prophylaxis practices both in our country and in the world. In this study, we aimed to investigate the clinical and epidemiological features of suspected rabies-contact children admitted to our hospital.

Methods: In our study, pediatric patients who were admitted to the Pediatric Emergency Department of Eskişehir Osmangazi University Faculty of Medicine between January 2013 and June 2021 with contact an animal which has a rabies risk were evaluated retrospectively. Epidemiological and clinical features of 746 pediatric cases included in the study, and prophylaxis practices after suspected rabies exposure were evaluated.

Results: Of the 746 cases included in the study, 55% were male, and the mean age was 102 months (4 months-216 months). Of the cases, 94% resided in the city and 6% resided in the countryside. There was cat contact in 54% and dog contact in 46% of the cases. Of contact animals, 84% were waif and 89% were unvaccinated. While 82% of suspected rabies contacts were in category-2, 60% had upper extremity contact and 21% lower extremity contact. Rabies vaccine was administered to 99%, rabies immunoglobulin to 10%, tetanus prophylaxis to 32%. Immunoglobulin, antibiotic, tetanus prophylaxis, suturing and hospitalization were higher in the dog-contact group than in the cat-contact group. Compliance with the rabies vaccination schedule was high in both groups.

Conclusions/Learning Points: Our study shows that rabies suspected contact cases should be mostly with waif and unvaccinated animals, and precautions such as vaccinating and sheltering stray animals should be increased. Rabies, which is still a deadly public health problem for the whole world and for our country, can be prevented by vaccination, post-exposure prophylaxis practices and community education.

EP581 / #746

Topic: AS16. Others

CELLULAR AND HUMORAL ANAMNESTIC IMMUNE RESPONSES TO 13-VALENT PNEUMOCOCCAL CONJUGATE VACCINE (PCV13) IN CHILDREN WITH IDIOPATHIC NEPHROTIC SYNDROME (INS)

E-Posters

E-POSTER VIEWING

Konstantina Kitsou¹, Varvara Askiti², Argyroula Zampetoglou², Andromachi Mitsioni², Marianna Tzanoudaki³, Emmanouil Liatsis³, Gkikas Magiorkinis⁴, Vassiliki Spoulou¹

¹Aghia Sophia Children's Hospital, Immunobiology And Vaccine Research Lab, Athens, Greece, ²P. and A. Kyriakou" Children's Hospital, Department Of Nephrology, Athens, Greece, ³Specific Reference Centre for Primary Immunodeficiencies-Paediatric Immunology, "Aghia Sophia" Children's Hospital, Department Of Immunology & Histocompatibility, Athens, Greece, ⁴Medical School, National and Kapodistrian University of Athens, Department Of Hygiene, Epidemiology And Medical Statistics, Athens, Greece

Backgrounds: Children under immunosuppression often demonstrate lower vaccine-induced protection. We evaluated the immunogenicity and the persistence of antibodies induced by PCV13 booster against Pneumococcal Serotypes(PS1,PS3,PS7F,PS9V,PS19A),and its effect on PS1-and PS9V-specific Memory B-cells(MBCs),in children with treated INS.

Methods: Paediatric INS patients under corticosteroids(n=17)-GroupA,Immunomodulatory Treatments(IMTs)-Cyclosporine-A(CsA) and mycophenolate mofetil(n=10)-GroupB and age-matched controls(n=17)-GroupC received a PCV13 booster. Sera was collected before,one-month(1M) and 12-months(12M) after PCV13. PS-specific IgG-antibodies in sera were quantified using the WHO ELISA protocol. For the PS-specific MBCs evaluation,PBMCs were isolated from 9 of these INS patients [CsA(n=4)/corticosteroids(n=5)], and controls(n=6), at baseline and at 1M. A novel Flow Cytometry protocol was applied, utilizing chemically-biotinylated-polysaccharides incubated with anti-biotin-coated beads and anti-biotin PE-antibodies,CD10-APC-AlexaFluor-750,CD20-ECD,CD19-PC7,CD27-PC5.5. PS-specific MBCs were identified as CD19⁺CD20⁺CD10⁺CD27⁺PS⁺ events;MBC counts were calculated using a separate B-cell count measurement.

Results:

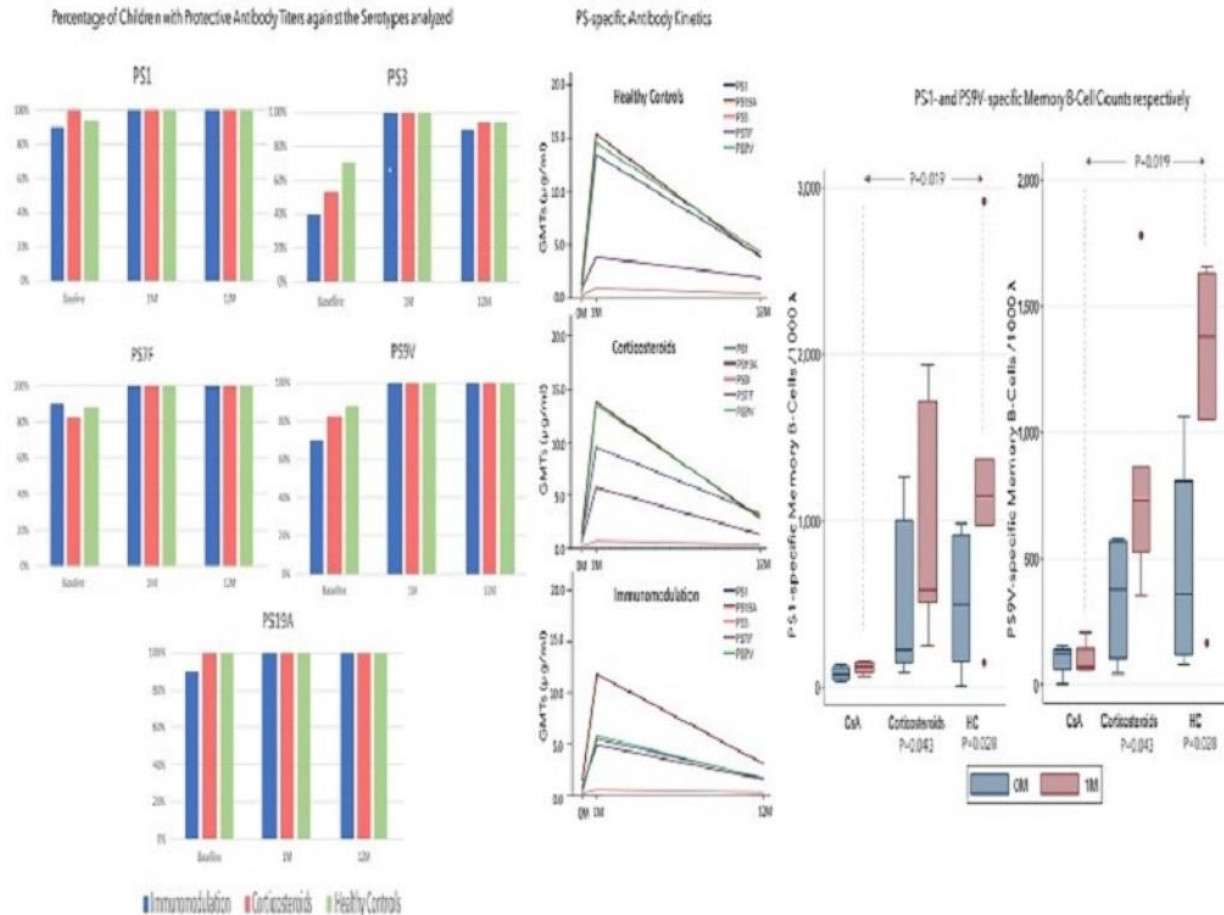

The percentage of the children with protective titers per group are shown in Figure. At baseline, no significant differences in the Geometric Mean Titers (GMTs) against the serotypes evaluated were observed among groups. GMTs significantly increased at 1M and 12M, in all groups for all Serotypes ($p < 0.05$). Lower GMTs were observed in Group B compared to Group C for PS1/3/9V at both timepoints ($p < 0.05$). No significant differences in the GMTs against the serotypes evaluated were observed between Group A and Group C, and between Group B and Group C for PS7F/19A. At baseline, the levels of antigen-specific MBCs did not differ between INS children and controls. At 1M, antigen-specific MBCs in children under CsA were significantly lower compared to controls for both serotypes (both $p = 0.019$); no differences were found between children under corticosteroids and controls. Antigen-specific MBCs significantly increased in controls and patients under corticosteroids ($p < 0.05$), contrary to patients under CsA.

Conclusions/Learning Points: A booster PCV13 was beneficial for children under IMT. Our results indicate a negative effect of these treatments on the longevity of PCV13-induced protection.

Acknowledgements: ESPID Small Grant Award (2021).

EP582 / #638

Topic: AS16. Others

INFLUENZA VACCINE RESPONSES IN ADOLESCENTS WITH OBESITY ARE SIMILAR TO ADOLESCENTS WITH NORMAL WEIGHT

E-Posters

E-POSTER VIEWING

Iris Kristinsdottir^{1,2}, Ásgeir Haraldsson^{1,2}, Siggeir Brynjolfsson^{2,3}, Tryggvi Helgason⁴, Valtyr Thors^{1,2}
¹Children's Hospital Iceland, Department Of Infectious Diseases And Immunology, Reykjavík, Iceland, ²University of Iceland, Faculty Of Medicine, School Of Health Sciences, Reykjavík, Iceland, ³Landspítali University Hospital, Department Of Immunology, Reykjavik, Iceland, ⁴Children's Hospital Iceland, Department Of Obesity, Reykjavik, Iceland

Backgrounds: Obesity is one of the major public health challenges worldwide. It has been associated with increased severity of influenza infections in adults and may be similar in children. Obesity has been associated with reduced immune response to tetanus and hepatitis B vaccinations. The aim of the study was to assess the humoral response to influenza vaccinations in obese adolescents and determine whether dose adjustments are needed to better protect this potential risk group.

Methods: 30 adolescents with obesity and 30 controls with normal weight, aged 12-18 years, were recruited. Participants received tetravalent influenza vaccination (2020/2021 season). Venous blood was collected prior to the vaccination and again four weeks later. Participants underwent body composition measurements (height, weight, body fat percentage, waist circumference). Haemagglutination inhibition assay was done to assess the humoral immune response. Seroconversion was defined as four-fold rise in titre post-vaccination.

Results: 29/30 participants in the study group and 30/30 of controls completed the study. The median BMI was 36 and 19, for the study and control group, respectively. The median body fat percentage was 48% for the study group and 18% in the control group. The study group had higher post-vaccination titres against the B Victoria strain, titres were similar against other strains. Seroconversion in the study group occurred in 29/29, 27/29, 28/29 and 27/29 against A H1N1, A H3N2, B Victoria and B Yamagata, respectively. For the control group, seroconversion was observed against A H1N1, A H3N2, B Victoria and B Yamagata in 28/30, 27/30, 30/30 and 24/30, respectively.

Conclusions/Learning Points: Teenagers with obesity do not have lower humoral response to influenza vaccination than teenagers with normal weight peers. Our study does not support any need for changes in dosing.

EP583 / #553

Topic: AS16. Others

WAS THE CHANGE OF THE RECOMMENDATION FOR PNEUMOCOCCAL VACCINATION FROM A 3+1 TO A 2+1 SCHEDULE IN TERM INFANTS ACCOMPANIED BY AN INCREASED VACCINATION ACCEPTANCE?

E-Posters

E-POSTER VIEWING

Katharina Schley¹, Christof Von Eiff², Kathrin Borchert³, Karolin Seidel³, Christian Jacob³, Maren Laurenz²
¹Pfizer Deutschland GmbH, Heor, Berlin, Germany, ²Pfizer Pharma GmbH, Vaccines, Berlin, Germany, ³Xcenda GmbH, Eu Real World Evidence, Hannover, Germany

Backgrounds: In August 2015, the German Standing Committee on Vaccination (STIKO) changed the pneumococcal conjugate vaccination (PCV) schedule for term infants from a 3+1 (2, 3, 4, and 11-14 months) to a 2+1 scheme (2, 4, and 11-14 months). It was expected that a reduction might lead to a higher acceptance of vaccination. Study aim was to assess vaccination rates and timeliness for PCV according to STIKO after change of recommendation based on real-world data.

Methods: A retrospective claims data analysis using the InGef Research Database containing an age and gender representative sample of the statutory health insured population in Germany was conducted. The study population of this analysis consisted of all term infants in this database born in 2013 (last cohort completely under 3+1 recommendation) or in 2016 respectively 2018 (first respectively third cohort completely under 2+1 recommendation) with an individual follow-up of 24 months.

Results: After follow-up of 24 months, 91.4% (90.9%/91.2%) of the 2018 (2016/2013) birth cohort received at least one PCV dose. Of the 2013 cohort, 68.3% received a booster dose according to the 3+1 schedule. Regarding the 2016/2018 cohort, 75.6%/76.7% received a booster dose presumably either according to the 2+1 (71.7%/73.8%) or 3+1 (3.9%/3.0%) schedule. If administered, the booster dose was received within the recommended timeframe only in 47.1% (2018), 46.3% (2016), and 45.1% (2013).

Conclusions/Learning Points: So far, there is no clear evidence that the reduction of the PCV schedule for term infants induced a higher acceptance of vaccination. The rate of unvaccinated infants remained constant, and vaccinations continued to be often delayed. Although the rate for the booster dose increased, 23% of term infants born in 2018 still did not receive a PCV booster dose.

EP584 / #897

Topic: AS16. Others

POTENTIAL IMPACT OF TWO DIFFERENT RECOMMENDATIONS FOR PNEUMOCOCCAL VACCINATION IN PRETERM (3+1) AND TERM (2+1) INFANTS – A CLAIMS DATA ANALYSIS IN GERMANY

E-Posters

E-POSTER VIEWING

Katharina Schley¹, Christof Von Eiff², Kathrin Borchert³, Karolin Seidel³, Christian Jacob³, Maren Laurenz²
¹Pfizer Deutschland GmbH, Heor, Berlin, Germany, ²Pfizer Pharma GmbH, Vaccines, Berlin, Germany, ³Xcenda GmbH, Eu Real World Evidence, Hannover, Germany

Backgrounds: In August 2015, the German Standing Committee on Vaccination (STIKO) changed the pneumococcal conjugate vaccination (PCV) schedule for term infants (TI) from a 3+1 (2, 3, 4, and 11-14 months) to a 2+1 scheme (2, 4, and 11-14 months). For preterm infants (PI), the 3+1 schedule remained unchanged. Study aim was to assess vaccination rates and timeliness (as recommended by STIKO) for PCV in PI after the change of recommendation for TI based on real-world data.

Methods: A retrospective claims data analysis was conducted using the InGef Research Database containing an age and gender representative sample of the statutory health insured population in Germany. The study population consisted of all PI in the database (identified by ICD-10-GM codes P07.2 and P07.3) born in 2013, 2016 or 2018 with an individual follow-up of 24 months. Hexavalent (HEXA) combination vaccination with a consistent 3+1 recommendation for TI and PI was analyzed as reference.

Results: After follow-up of 24 months, 70.4% (68.3%/65.5%) of PI of birth cohort 2018 (2016/2013) received the four recommended HEXA vaccinations. At the same age, only 46.6% (40.5%/64.5%) of PI obtained the four recommended PCV doses and 4.6% (5.9%/5.8%) received no PCV at all. Of those receiving the PCV booster dose, only 50.1% (2018), 47.6% (2016) and 44.4% (2013) received the fourth PCV on time as recommended by STIKO.

Conclusions/Learning Points: Although STIKO still recommends a 3+1 PCV schedule for PI in Germany, only 46.6% of all PI received the four recommended doses within 24 months whereas 31.6% presumably received a 2+1 schedule. Vaccinations were often delayed and about 5% of all infants remained unvaccinated. In order to protect this vulnerable group, efforts are needed to increase adherence to STIKO recommendation.

EP585 / #76

Topic: AS16. Others

SEVERE INTESTINAL PSEUDO-OBSTRUCTION ASSOCIATED WITH ACUTE EPSTEIN-BARR VIRUS INFECTION IN A 2 YEAR OLD BOY

E-Posters

E-POSTER VIEWING

Peter Paul Lim¹, Meenal Thadasina², Louise Sawaya³, Sandeep Sarkaria⁴, Joao Pedro Matias Lopes⁴, Eichii Miyasaka⁵, David Zhang¹

¹University Hospitals-Rainbow Babies and Children's Hospital, Pediatric Infectious Diseases, Cleveland, United States of America, ²University Hospitals-Rainbow and Babies Children's Hospital, Pediatrics, Cleveland, United States of America, ³University Hospitals Cleveland Medical Center, Department Of Medicine And Pediatrics, Cleveland, United States of America, ⁴University Hospitals-Cleveland Medical Center, Department Of Allergy And Immunology, Cleveland, United States of America, ⁵University Hospitals-Cleveland Medical Center, Pediatric Surgery, Cleveland, United States of America

Title of Case: SEVERE INTESTINAL PSEUDO-OBSTRUCTION ASSOCIATED WITH ACUTE EPSTEIN-BARR VIRUS INFECTION IN A 2 YEAR-OLD-BOY

Background: Epstein-Barr virus (EBV) can be responsible for a wide array of clinical presentations. However, obstructive CT findings and abdominal tenderness warranting diagnostic surgical intervention from acute EBV infection has not been previously described in literature.

Case Presentation Summary: A 2-year-old boy with G6PD deficiency, otherwise healthy, presented with 5-day history of high-grade fevers, nasal congestion, fatigue, vomiting, diarrhea, and progressive abdominal distension. His initial laboratory findings are significant for elevated inflammatory markers, hyponatremia, elevated creatinine and mild transaminitis. Abdominal CT showed diffuse dilatation of the intestines but with a transition point in the left mid-abdomen consistent with bowel obstruction. He underwent diagnostic surgical exploration demonstrating transition point in mid-jejunum and diffusely dilated bowel throughout without mechanical obstruction (image). The mesentery appeared edematous but there was no ischemic or necrotic area or any mass noted. His post-operative course was complicated by prolonged ileus. Empiric antibacterial agents were discontinued when bacterial cultures were negative. His extensive infectious work up revealed acute EBV infection with viremia of 212,026 IU/ml. His preliminary immunologic work up did not demonstrate any primary inborn error of immunity. He was discharged on hospital day 9. Repeat EBV testing two weeks later showed decreased viral load to 2194 IU/ml. He continued to recover well on supportive



management.

Learning Points/Discussion: EBV can manifest in variable clinical presentations including what seems like a surgical abdomen from severe ileus resulting in severe intestinal dilatation. It is therefore prudent to consider acute EBV infection part of the differential diagnosis in a pediatric patient who presents with intestinal distension with no apparent radiologic mechanical obstruction.

EP586 / #543

Topic: AS16. Others

HYDROA VACCINOFORME: AN EXTREMELY RARE SKIN DISORDER ASSOCIATED WITH EPSTEIN-BARR VIRUS

E-Posters

E-POSTER VIEWING

Peter Paul Lim¹, Smitha Hosahalli Vasanna², Chaithra Sreenath², Sonia Gera³, Irina Pateva², Sonal Shah⁴, Amy Edwards¹, Kathryn Ruda Wessell⁵

¹University Hospitals-Rainbow Babies and Children's Hospital, Pediatrics, Division Of Pediatric Infectious Diseases, Cleveland, United States of America, ²University Hospitals-Rainbow Babies and Children's Hospital, Pediatrics, Division Of Pediatric Hematology-oncology, Cleveland, United States of America, ³University Hospitals-Rainbow Babies and Children's Hospital, Pediatrics, Cleveland, United States of America, ⁴University Hospitals-Rainbow Babies and Children's Hospital, Dermatology, Cleveland, United States of America, ⁵University Hospitals-Rainbow Babies and Children's Hospital, Pediatrics, Division Of Pediatric Allergy, Immunology And Rheumatology, Cleveland, United States of America

Title of Case: HYDROA VACCINOFORME: AN EXTREMELY RARE SKIN DISORDER ASSOCIATED WITH EPSTEIN-BARR VIRUS

Background: Epstein-Barr virus (EBV) is implicated in a myriad of clinical presentations. A very rare chronic photosensitizing cutaneous disorder in childhood with sporadic epidemiology, Hydroa Vacciniforme (HV), is associated with chronic EBV infection albeit its pathogenesis remains enigmatic. HV exists in the spectrum of EBV-related lymphoproliferative disorders ranging from an exclusive cutaneous presentation to a multi-systemic involvement.

Case Presentation Summary: A previously healthy 7-year-old boy presented with a one-year history of relapsing and remitting vesicular eruption of his bilateral ear lobes, neck and face following sun exposure. The involved areas initially developed erythema and edema with overlying vesicles, which evolved into necrotic plaques with overlying eschar, and eventually healed with varioliform scarring, characterized by depressed atrophic macules. Photoprotected areas of his body were uninvolved. Initial whole blood EBV viremia was 221,508 IU/mL with plasma viral load of 2,351 IU/mL. Skin biopsy from left lateral neck lesion showed spongiosis and interface dermatitis with a perivascular lymphocytic infiltrate and papillary edema, consistent with early HV. Mesenteric lymph node biopsy demonstrated paracortical hyperplasia, reactive follicles at variable stages of maturation and scattered EBV cells. Lymph node biopsy was negative for lymphoma. Immunologic work up did not demonstrate immunodeficiency. Serum protein immunofixation test was normal. Genetic testing showed six variants of unknown significance. Recurrence of intermittent lesions was prevented by strict



photorestriction.

Learning Points/Discussion: EBV is associated with variable cutaneous lesions. HV should be considered when remitting and relapsing vesicles or crusted papules occur on sun-exposed areas especially among children. Skin and lymph node biopsy are necessary to establish the HV diagnosis, and further evaluation for EBV associated lymphoproliferative disorders and underlying inborn errors of immunity is imperative.

EP587 / #1230

Topic: AS16. Others

VIRAL RESPIRATORY PATHOGENS DETECTED AMONG CHILDREN 0-5 YEARS DURING THE COVID-19 PANDEMIC IN BULGARIA

E-Posters

E-POSTER VIEWING

Ivelina Trifonova¹, Veselin Dobrinov¹, Iliana Grigorova¹, Svetla Angelova¹, Iveta Madzharova¹, Silviya Voleva¹, Chiydem Ismailova¹, Lybomira Grigorova¹, Ivaylo Alexiev¹, Tatiana Tcherвениakova², Ralitsa Yordanova², Neli Korsun¹

¹National Center of Infectious and Parasitic Diseases, Virology, Sofia, Bulgaria, ²Infectious Diseases Hospital "Prof. Ivan Kirov", Clinic Of Pediatric Infectious Diseases, Sofia, Bulgaria

Backgrounds: Acute respiratory infections are a major cause of morbidity and hospitalizations in children. This study aimed to determine the role of co-infections involving SARS-CoV-2 as a cause of acute respiratory infections in childhood.

Methods: Nasopharyngeal samples were taken prospectively from outpatients and inpatients aged 0-5 years treated for ARI in different regions of the country from December 2020 to December 2021. Real-time PCR was performed for SARS CoV-2, influenza viruses, and 8 common respiratory viruses - respiratory syncytial virus (RSV), human metapneumovirus (HMPV), parainfluenza viruses (PIV)1/2/3, rhinoviruses(RV), adenoviruses (AdV), and bocaviruses (BoV).

Results: Of 500 children studied, 144(22.8%) were positive for SARS CoV-2. Among the children infected with SARS CoV-2, 21(14.5%) cases of co-infections were found in combination with one respiratory virus and 1(0,7%) with two viruses. The most frequently identified co-pathogens with SARS CoV-2 were BoV(n=8;36%), followed by RV(n=4;18%), RSV(n=4;18%), HMPV(n=1;4.5%), AdV(n=3;13.6%). Of 385 SARS CoV-2-negative children, at least one respiratory virus was detected in 147 (38%). Influenza viruses were not identified. The most commonly detected pathogen was RSV (n=75, 19.4%), followed by BoV(n=56;14.8%), RV(n= 36;9.3%), PIV3(n=22;5.7%), AdV(n=15; 3.8%), and HMPV(n=12;3.1%). The incidence of non-SARS CoV-2 respiratory viruses was low in the winter and autumn months of 2021 when the incidence of SARS-CoV-2 was high and increased sharply in June, July, and August when the incidence of SARS CoV-2 reduced. On the other hand, the share of co-infections with SARS CoV-2 in February(13.6%), March(18.2%) and September(18%), October (21.7%) were higher than in the summer months.

Conclusions/Learning Points: During the COVID-19 pandemic, the incidence of respiratory infections in children 0-5 years of age was lower than in the previous seasons (70-80%). RSV and other non-influenza viruses showed unusual seasonal activity during the study period.

EP588 / #677

Topic: AS16. Others

ONYCHOMYCOSIS IN CHILDREN: A CASE REPORT OF 10 PATIENTS

E-Posters

E-POSTER VIEWING

Diakité Mamoudou, Cissé Lamissa, Dembele Fatoumata, Dicko Adama Aguisa, Sissoko Madou, Faye Ousmane

Hospital Dermatology of Bamako, Dermatology, Bamako, Mali

Title of Case: children's onychomycosis

Background: Onychomycosis is uncommon in children with an estimated prevalence of 0,5%. Although, in tropical area predisposing factors are met to favor fungal infection, studies are scarce and identification of etiological agent is rarely performed. This study is aimed at investigating the etiological agents of onychomycosis in children in Bamako Dermatology Hospital.

Case Presentation Summary: Cases

All patients consulting for nail dystrophy were examined for onychosis. Of 23 patients, 10 were confirmed during six months (Table 1)

| Num | Age | sex | Origine | topography | Clinical features | Direct microscopy research mycelial filament | culture |
|-----|-----|-----|---------|------------------|--|--|-------------------|
| 1 | 10 | F | Urban | 1 finger | Greyish nails, dermatophytosis | Positive | T souda |
| 2 | 15 | F | Urban | 1 finger | Black nails, dermatophytosis | negative | Candida |
| 3 | 10 | F | Rural | 4 fingers | Greyish, dermatophytosis | Positive | Asperg Niger |
| 4 | 15 | M | Urban | 6 fingers/3 toes | Dystrophy nails | Positive | T souda |
| 5 | 11 | F | Urban | 6 toes | Greyish nails, tinea capitis | positive | Candida |
| 6 | 15 | M | Urban | 1finger/3 toes | Yellowish nails, paronychia | Negative | Candida |
| 7 | 7 | M | Rural | 4 fingers/6 toes | Greyish nails, dermatophytosis, paronychia | Positive | Asperg versicolor |
| 8 | 13 | F | Urban | 3 fingers | Normal colour nails, tinea capitis | Positive | T souda |
| 9 | 12 | F | Urban | 8 toes | Greyish nails | Positive | Candida |
| 10 | 11 | M | Urban | 2 fingers/1 toe | Black nails, tinea capitis | Positive | T souda candida |

Learning Points/Discussion: Discussion : In our series, most of the children are teenagers presenting with nail changes (dystrophy, color change) combined with other skin manifestations of fungal infection such as tinea capitis and tinea corporis. The later in

addition to the identification of *T soudanense* would indicate that the most likely cause of the nail infection is from a cutaneous focus. The prevention of onychomycosis requires early treatment of fungal skin infections.

EP589 / #961

Topic: AS16. Others

BARTONELLA HENSELAE ENCEPHALOPATHY IN A PEDIATRIC PATIENT

E-Posters

E-POSTER VIEWING

Tamima Hossain¹, Ihinosen Edgal¹, Joan Dickerson², Yamini Mandelia³

¹East Carolina University, Pediatrics, Greenville, United States of America, ²Hemby Children's Hospital, Pediatrics, Charlotte, United States of America, ³East Carolina University, Pediatrics- Infectious Disease, Greenville, United States of America

Title of Case: Bartonella henselae encephalopathy in a pediatric patient

Background: Bartonella henselae is a well-known cause of Cat Scratch Disease, with a rare manifestation of encephalopathy. The purpose of this report is to present a patient's summarized data, and to discuss the authors approach to work-up and management of Bartonella henselae encephalopathy.

Case Presentation Summary: We report a case of a healthy 13-year-old boy who presented with fever, right axillary lymphadenitis x 2 weeks and altered mental status x 24 hours in the setting of exposure to kittens. His white blood cell count and inflammatory markers were elevated. Given the fevers and altered mental status, lumbar puncture was completed to rule out bacterial meningitis, the results of which showed no meningitis. Bartonella henselae titers were sent and returned positive. He was empirically started Doxycycline and Rifampin. His fevers resolved, right axillary lymphadenitis improved, mental status returned to baseline and inflammatory markers improved within 48 hours of the start of antibiotics. He was discharged home to complete 3 weeks of antimicrobial therapy, however, he stopped short due to intolerance.

Learning Points/Discussion: There is paucity of literature on management of Bartonella encephalopathy. Reports have described patients on prolonged antibiotics as well as no antibiotics. Antibiotic therapy tends to have a dramatic clinical response in immunocompromised patients, but minimal response in the immunocompetent. Some literature suggests treating immunocompetent patients by supportive care, with most patients recovering without lasting neurological damage. This report is our attempt to share insight into this unique case to increase awareness and medical knowledge. Our patient's quick resolution of symptoms and short antimicrobial therapy suggests perhaps prolonged antimicrobials are not needed for immunocompetent patients.

EP590 / #904

Topic: AS16. Others

A CASE OF BACTEREMIA DUE TO HAEMOPHILUS INFLUENZA TYPE B IN A HEALTHY FULLY IMMUNIZED 12-YEAR-OLD BOY

E-Posters

E-POSTER VIEWING

Konstantina Patouni, Antonios Ispanopoulos, Katerina Oikonomopoulou, Vasiliki Korentzelou, Dimitrios Delis, [Mersyni Mavrikou](#)
"P&A Kyriakou" Children's Hospital, First Paediatric Department, Athens, Greece

Title of Case: A case of bacteremia due to Haemophilus Influenza type B in a healthy fully immunized 12-year-old boy

Background: Haemophilus Influenza type b (Hib) was one of the leading causes of invasive bacterial infections in early childhood prior to the introduction of immunization. Due to the excellent immunogenicity of Hib conjugate vaccines, such cases are nowadays rare.

Case Presentation Summary: A previously healthy 12-year-old boy presented to the emergency department with a history of acute right sided chest pain and fever of recent onset. Upon examination, he appeared unwell and tachycardic. Decreased air entry in the right hemithorax was noted. Blood tests revealed elevated inflammatory markers. On chest X-ray, infiltrates of the lower lobes were present. An ultrasound of the right hemithorax showed a small pleural effusion. After obtaining blood and urine cultures, the patient was started on intravenous ceftriaxone. Blood culture was positive for Hib, which was susceptible to third generation cephalosporines. The patient improved shortly after initiation of antibiotic treatment and completed a ten day course of intravenous ceftriaxone. An abdominal ultrasound was performed and confirmed the presence of spleen. Despite the fact that the patient was fully immunized, antibodies against Hib were negative upon admission. Immunoglobulin classes and subclasses levels, as well as complement levels were normal. Three weeks after the admission, an antibody response against Hib was found.

Learning Points/Discussion: After the implementation of catholic immunization against Hib in western countries, cases of invasive disease are rare and mainly affect non-immunized or immunocompromised children of younger age. The presented case of Hib bacteremia in a fully immunized healthy 12-year-old child is unusual.

EP591 / #910

Topic: AS16. Others

A RARE CASE OF BACTEREMIA DUE TO KLEBSIELLA PNEUMONIAE PRESENTING WITH RASH IN A 9-MONTH-OLD INFANT

E-Posters

E-POSTER VIEWING

Konstantina Patouni¹, Katerina Oikonomopoulou², Dimitrios Pagourdakis², Mersyni Mavrikou², Dimitrios Delis², Andriani Vazeou²

¹P&A Kyriakou Children's Hospital, First Paediatric Department, Athens, Greece, ²"P&A Kyriakou" Children's Hospital, First Paediatric Department, Athens, Greece

Title of Case: A rare case of bacteremia due to Klebsiella Pneumoniae presenting with rash in a 9-month-old infant

Background: Klebsiella Pneumoniae is the second most common cause of gram negative bacteremia following Eschericia coli. The presence of rash in patients with bacteremia caused by Klebsiella pneumoniae is extremely rare.

Case Presentation Summary: A previously healthy 9-month-old infant was admitted with a two day history of fever and rash. Upon admission, the patient was in good condition and hemodynamically stable. On examination, generalized maculopapular rash of red-purple colour with vasculitic and hemorrhagic lesions was noted. Inflammatory markers were elevated (CRP: 95 mg/dl, procalcitonin: 33,75 ng/dl). Coagulation studies revealed increased levels of d-dimers, while troponin and ferritin levels were within normal limits. Cardiology evaluation, a chest x-ray and an abdominal ultrasound were performed and were normal. Intravenous treatment with ceftriaxone was initiated. Due to clinical suspicion of MIS-C, the patient was also administered intravenous immunoglobulin at a dose of 2 gr/kg. Blood culture was positive for Klebsiella pneumoniae and intravenous amikacin was added to the therapeutic scheme, which was later discontinued based on antibiogram results. Intravenous antibiotics were administered for a total course of ten days. Fever subsided on the fourth day of treatment, while the rash gradually improved. Serology testing for Sars-Cov-2 was negative. The clinical course of the patient and the presence of an alternate diagnosis ruled out MIS-C.

Learning Points/Discussion: Skin manifestations are an atypical clinical finding in patients with bacteremia due to Klebsiella Pneumoniae and have been described in a very small number of patients that mainly belong to the neonatal age group. The diagnosis of MIS-C should be considered and ruled out in patients that present with fever, rash and high inflammatory markers.

Topic: AS16. Others

MICROARRAY RESULTS FROM NASOPHARYNGEAL LYTA-POSITIVE CHILDREN AND ADULTS: OBSERVATIONAL DATA FROM THE TRANSMISSION OF PNEUMOCOCCUS (TOP) STUDY

E-Posters

E-POSTER VIEWING

Jane Metz^{1,2}, Leon Danon³, Begonia Morales-Aza¹, Kate Gould^{4,5}, Jenifer Oliver¹, Elizabeth Oliver¹, Kaltun Duale¹, Helen Rice¹, Paul Heath⁶, Shari Sapuan⁶, Saul Faust⁷, Matthew Snape⁸, Stephen Hughes⁹, Jason Hinds^{4,5}, Bradford Gessner¹⁰, Adam Finn^{1,2}

¹University of Bristol, Bristol Vaccine Group, Bristol, United Kingdom, ²Bristol Royal Hospital for Children, Paediatric Immunology And Infectious Diseases, Bristol, United Kingdom, ³University of Bristol, Mathematics, Bristol, United Kingdom, ⁴University of London, Institute For Infection And Immunity, London, United Kingdom, ⁵Bioscience Innovation Centre, Bugs Bioscience, London, United Kingdom, ⁶St George's, University of London, Paediatric Infectious Diseases Research Group, London, United Kingdom, ⁷University Hospital Southampton, Nihl Clinical Research Facility, Southampton, United Kingdom, ⁸University of Oxford, Oxford Vaccine Group, Oxford, United Kingdom, ⁹Manchester University NHS Foundation Trust, Paediatric Allergy And Immunology, Manchester, United Kingdom, ¹⁰Pfizer Vaccines, Medical Development And Scientific Clinical Affairs, Collegeville, United States of America

Backgrounds: Understanding streptococcal pneumoniae (Sp) carriage and transmission is fundamental to preventing invasive pneumococcal disease. Microarray provides highly sensitive/specific serotype data, potentially useful in elucidating transmission pathways.

Methods: Across 10 UK-sites, 405 household family units (1378 participants; a unit = 2-year-old (index) child + 2+ household contacts) were enrolled as part of the Transmission of Pneumococcus Study. 5 serial nasopharyngeal samples (NPS) were collected 2-weekly over 2 months from each participant (October-December 2017 and 2018). LAIV was given to the index child on either day 0 or day 28.

Results: At baseline, 274/405 index children were lytA positive and analysed by microarray. 240 samples were carrying Sp serotypes. The four most common serotypes were 15B/C, 11A, 21 and 35F, present in 102 index participants (table 1). 71 of these index children had household contacts with lytA-positive samples. These were then also analysed by microarray (330 samples). In 45/71 families, index children shared ≥ 1 serotypes with ≥ 1 household contacts. 43% of lytA NPS analysed had multiple serotype/strain carriage. Table 1. The 4 most carried Sp serotypes (index, baseline)

| Serotype | n | Single (multiple) strain/serotype(s) | Families (contacts) with same serotype | Family (contacts) carrying serotype without index carriage |
|----------|------------------------------|--------------------------------------|--|--|
| 15B/C | 42 | 28 (14) | 19 (24) | 5 (6) |
| 11A | 27 | 14 (13) | 13 (17) | 7 (8) |
| 21 | 22 | 12 (10) | 6 (7) | 6 (6) |
| 35F | 17 | 11 (6) | 7 (9) | 2 (4) |
| Total | 108 (102 index participants) | 65 (43) | 45 (57) | 20 (24) |

Conclusions/Learning Points: NP carriage of the same Sp serotypes by multiple household members supports that household Sp transmission occurs. Multiple serotype carriage

was observed in a significant proportion of participants. Further data analysis is investigating the role of Sp density in serotype commonality and Sp vs non-Sp streptococci.

EP593 / #1109

Topic: AS16. Others

IN [CAT] SICKNESS AND IN HEALTH” - SPOROTRICHOSIS AS A DIFFERENTIAL DIAGNOSIS OF PERSISTENT AND REFRACTORY SKIN LESIONS

E-Posters

E-POSTER VIEWING

Camila Morais¹, Giovanna Guerra², Marcus Martuchelli¹, Samantha Matos², Daniel Jarovsky², Flávia Almeida³, Eitan Berezin⁴, Marco Aurélio Palazzi Sáfy³, Mariana Arnoni²

¹Santa Casa de São Paulo, Pediatric Infectious Disease, São Paulo, Brazil, ²Santa Casa de São Paulo, Pediatric Infectious Diseases, São Paulo, Brazil, ³Sabará Children’s Hospital, Pediatric Infectious Diseases, São Paulo, Brazil, ⁴Santa Casa, Pediatric, SAo Paulo, Brazil

Title of Case: In [cat] sickness and in health” - Sporotrichosis as a differential diagnosis of persistent and refractory skin lesions

Background: Sporotrichosis is caused by fungi of the genus *Sporothrix*. The first cases related the inoculation on the skin or mucous membrane by trauma with contaminated plant material or soil, but zoonotic transmission has also been reported. Were present two cases of cat-transmitted sporotrichosis, an endemic disease in several Latin American countries.

Case Presentation Summary: Case #1: A healthy 3-year-old boy was admitted with hyperemia, edema, pruritus, and purulent secretion in the right eye for one month, associated with a nodular lesion in the malar region and cervical inflammatory lymph nodes on the same side. There was recent intimate contact with a domestic cat with sporotrichosis. Culture-confirmed sporotrichosis was treated with itraconazole for 6 months; symptoms improved after 2 months. Image 1 Case #2: A healthy 7-year-old girl was admitted with hyperemia, edema, pruritus, and purulent secretion in the left hand for 1 month, after a healthy cat bite. Skin lesions and ulcers ascended to the left arm. She was first treated with cefalexin, then amoxicillin-clavulanate, and ciprofloxacin, without significant clinical improvement. Sporotrichosis was considered as a differential diagnosis, culture was performed and empirical potassium iodide oral solution was initiated; symptoms greatly improved in the first weeks of treatment. IMAGE 2





Learning Points/Discussion: Sporotrichosis should be considered as a differential diagnosis in refractory skin infections, especially when an epidemiologic link to cats (sick or not) is present. Treatment is curative but sequelae can occur if diagnostic and adequate treatment is delayed.

EP595 / #1875

Topic: AS16. Others

NEONATAL SEIZURE

E-Posters

E-POSTER VIEWING

Ergena Neziri¹, Laureta Sadedini¹, Mirzana Kapllanaj², Suela Demiraj³

¹Mother Teresa Hospital Center, Albania, Pediatric Emergency Department, tirana, Albania, ²Mother Teresa Hospital Center, Albania, Pediatric Onco-hematology Department, tirana, Albania, ³Hygea Hospital Albania, Hygea Hospital Albania, tirana, Albania

Title of Case: Neonatal Seizures

Background: Neonatal seizure is an occurrence of abnormal, paroxysmal and persistent ictal rhythm with an amplitude of 2 microvolts in electroencephalogram, detected in infants younger than 4 weeks. Common cause of neonatal seizure include hypoxic ischemic encephalopathy, intracranial haemorrhage, intracranial infection, congenital cerebral malformations metabolic disorders.

Case Presentation Summary: A 3-days -old girl was brought with the complaint of fever since 8 hours, weak crying since and not taking food since one day, uprolling of eyeballs since 20 minute. Baby was born at term by normal vaginal delivery. There was no postnatal event problem at the time of delivery. She cried immediately after delivery and also started breastfeeding. Examination: The girl was appearing to be appropriate for gestation She was lying without much movement, responding to the flickering of the sole by weak cry. Anterior fontanelle was full and tensed. Neonatal reflexes were sluggish and was hypotonic. The anthropometric measurements include weight 3kg, length 49cm, head circumference was 33cm. Baby was febrile 38.5°C. Laboratory findings: Wbc 18.5×10^3 , Rbc 4.5×10^6 , Hb 13g/dl, PCR 25 mg/dl, procalcitonin 10ng/ml, glycemia 86mg/dl, ph 7.37, pCO₂ 38mmHg, BE -1, serum electrolytes normal, CSF: turbid, leukocyte 102, polymorphs 60%, glucose 10mg/dl, protein 400 mg/dl, CSF gram stain negative. Treatment: On the first day of hospitalisation, due to repeated episodes of seizures was administered a single loading dose phenobarbital 20mg/kg, ampiciline 200mg twice a day, gentamicin 12mg once a day for a week. Baby recovers without sequelae and was discharged after clinical conditions and biochemical parameters improved

Learning Points/Discussion: Seizures are a common manifestation of serious central nervous system disease in the newborn. Seizures of different etiology will have different prognosis. Prompt diagnosis and intervention are indicated because seizures indicate serious underlying disease and may interfere with supportive care. The presence of neonatal seizures is the best predictor of long-term physical and cognitive deficits

EP596 / #1165

Topic: AS16. Others

USING OF INFORMATION TECHNOLOGIES DURING THE COVID-19 PANDEMIC

E-Posters

E-POSTER VIEWING

Zarema Obradovic

UNIVERSITY OF SARAJEVO, Faculty For Health Studies, SARAJEVO, Bosnia and Herzegovina

Backgrounds: The COVID-19 pandemic has caused many changes in everyday life, and one of them is related to the increased use of information technology, especially during the lock-down period. Schools switched to online teaching, and students spent several hours a day with a computer to monitor classes, and to complete school assignments. A large number of students spent most of their time in the apartment with video games, watching movies, or listening to music on their computers or mobile phones due to restrictions on movement. Prolonged sitting with electronic devices, often in an incorrect body position is not good for health.

Methods: The research was conducted in in three high schools using questionnaires that students filled out anonymously.

Results: There are significant differences in the length of time that students from different schools spend using information technologies. For 74.3% of students it was 2-4 hours a day. Over 6 hours a day, spend 12% of the students of the Gymnasium at the computer. Using of information technology in leisure time, which is most often stated by students of the High School of Economics, 28% spend over 3 hours every day. The largest percentage of students spend time with the computer in a supine position, which is an incorrect position that causes various health problems. The most common health problems are headache, eye problems, back and arm pain and they were most present in medical school students (45%: 38.2%: 52.7%: 34.5%).

Conclusions/Learning Points: High school students during the COVID-19 pandemic overuse information technologies, most often in the wrong position, which has a negative impact on their health and it is necessary to think about this problem and work on its prevention

EP597 / #1325

Topic: AS16. Others

EPIDEMIOLOGY AND MANAGEMENT OF CELLULITIS IN A PEDIATRIC EMERGENCY DEPARTMENT

E-Posters

E-POSTER VIEWING

Eider Oñate¹, Amaia Camara², Paula Mercado², Mikel Mata², Miriam Alkorta³, Cristina Calvo¹

¹Donostia University Hospital, Pediatrics, San Sebastian, Spain, ²Donostia University Hospital, Pediatric Emergency, San Sebastian, Spain, ³Donostia University Hospital, Microbiology, San Sebastian, Spain

Backgrounds: Patients with cellulitis commonly present to pediatric emergency departments(EDs). Most cases of nonfacial cellulitis are mild and can be treated with oral antibiotics, although some cases may be severe enough to warrant parenteral antibiotics. There is a great variability in antibiotic use and management among and within different settings. The main objective of this study was to determine antibiotic choices, routes of administration, and outcomes of children treated in our emergency route.

Methods: Observational and retrospective study carried out by reviewing the medical records of patients<14 years-old with a diagnosis of cellulitis in the emergency-room of a tertiary hospital of a Spanish province between January-2021 and December-2021. Data analyzed included: demographics; clinical presentation; laboratory and microbiology results; management, including choice, dose, and route of antibiotic(s); treatment-failures; hospital-admissions and time spent in the ED.

Results: 153 with cellulitis were identified. The mean-age was $5,7\pm 3,85$ years, and most were boys(84[55.0%]). Most infections occurred in summer. The majority involved the lower-extremity (n=67[43.7%]). A 7,8% of patients associated lymphangitis. Of 23 children from whom cultures were collected, a pathogen was isolated in 16(70%) being the most common S.Aureus(56%).110 patients were treated with oral antibiotics(OA), 23 with intravenous antibiotics(IA), and 20 received $2,6\pm 0,99$ doses of IA previous OA in emergency-observation unit. 27 patients required admission, 23 from the IA group and 4 from the mixed group. The most commonly prescribed antibiotic was amoxicillin-clavulanic acid. Treatment failure with OA occurred in 11(7.2%) of the cases.

Conclusions/Learning Points: Noncomplicated cellulitis is most commonly treated using amoxiciline-clavulanic. Treatment with oral antibiotics was effective in most of cases. A reasonable alternative for admission and IA regimen could be to give a single dose of intravenous antibiotics followed by a prescription for oral antibiotics

EP598 / #73

Topic: AS16. Others

THE IMPACT OF SOLUTION-FOCUSED BRIEF THERAPY ON THE QUALITY OF LIFE OF ADOLESCENTS LIVING WITH HIV: A QUASI- EXPERIMENTAL STUDY IN SEVEN TREATMENT HUBS IN CENTRAL LUZON

E-Posters

E-POSTER VIEWING

Marie Christel Penuliar-Retirado

JBLMGH, Pediatrics, City of San Fernando, Pampanga, Philippines

Backgrounds: Adolescents living with HIV ALHIV continue to be a vulnerable group as exemplified by a 50% increase in their deaths despite the global decrease in HIV- related deaths by 30%. This increase in adolescent HIV-related deaths is due primarily to poor prioritization of adolescents in national HIV plans, inadequate provision of accessible and acceptable HIV testing and counseling and treatment services, and the lack of support for adolescents to remain in care and adhere to antiretroviral therapy.

Methods: The quality of life of 27 ALHIV from JBLMGH Bahay Lingad, Lakan Community Center & Primary HIV Care Clinic, Villa Esperanza, HEARTH Unit JCPMGH, Bataan HAVEN, Luntiang Silong, and TPH Cares were assessed using the WHOQOL-HIV BREF Filipino version. WHOQOL-HIV BREF Filipino version was administered before and after two sessions of SFBT.

Results: There is a statistically significant improvement in patient's quality of life in terms of psychological domain ($t(26) = 2.13, p = <.05$) from 66.30 ± 17.24 to $72.22 \pm (p <.05)$ and environmental domain ($t(26) = 2.91, p = <.005$) from 73.61 ± 12.14 to $77.20 \pm 12.40 (p <.005)$ after the SFBT sessions. Based on the Pearson product-moment correlation, the physical domain was moderately correlated with the psychological domain ($r=0.588, p <.001$), social relationships domain ($r=.418, p <.05$), and environmental domain ($r=.544, p <.01$). The psychological domain was strongly correlated with the level of independence domain ($r=.70, p <.001$) and moderately correlated with the social relationships domain ($r=.452, p <.05$).

Conclusions/Learning Points: This study supports that we should give emphasis and importance to both the physical and psychological domains, which directly influence all the other domains, as a holistic approach in providing optimal care for ALHIV.

EP599 / #701

Topic: AS16. Others

PERPLEXING PAPULOVESICULAR RASH IN A TODDLER

E-Posters

E-POSTER VIEWING

Maja Pietrzak¹, Ewa Talarek^{1,2}, Magdalena Marczyńska^{1,2}

¹Regional Hospital of Infectious Diseases in Warsaw, Paediatric Infectious Ward, Warsaw, Poland, ²Medical University of Warsaw, Department Of Children's Infectious Diseases, Warsaw, Poland

Title of Case: Perplexing papulovesicular rash in a toddler.

Background: Eruptive pseudoangiomatosis is a rare condition that should be considered in a differential diagnosis of a patient with prolonged papular rash.

Case Presentation Summary:



Almost 2-year-old boy was admitted with a pruritic rash of 4-weeks duration. The rash started as papulovesicular lesions located on the face and limbs and was diagnosed as varicella by a general practitioner. No improvement was seen after treatment with acyclovir. The patient was consulted by a specialist of infectious diseases who suspected hand, foot and mouth disease and potential bacterial superinfection, additionally bilateral otitis media was found. Despite antibiotic treatment with cefuroxime there was no improvement in skin condition and after 6 days patient returned for the follow-up visit. The patient's mother reported persistent pruritus despite prolonged administration of antihistaminics and cough since the preceding day. On admission the patient was in good general condition, physical examination revealed papulovesicular rash on erythematous base localised mainly on face and limbs, diaper dermatitis and multiple symmetrical crackles on auscultation. RSV infection was confirmed. Supportive therapy was used. Resolution of abnormalities on auscultation was observed over few days but the rash persisted. Consulting dermatologists made diagnosis of eruptive pseudoangiomatosis and ordered topical tacrolimus. In few weeks gradual improvement of the skin condition was seen.

Learning Points/Discussion: Eruptive pseudoangiomatosis is a rare condition that appears on exposed

sites of the body and is characterised by erythematous papules encircled by a pale halo. It is self-resolving and the etiology remains unknown. Recognition of this entity is important, since it resolves spontaneously in about 3 weeks and does not require any further investigation.

EP600 / #818

Topic: AS16. Others

NEWBORNS WITH PERINATAL INFECTIOUS DISEASES RISK FACTORS: APPROACH IN A SECONDARY LEVEL NEONATAL PATHOLOGY UNIT

E-Posters

E-POSTER VIEWING

Alessandro Porta, Marta Bellini, Francesca Lizzoli, Luciana Parola
Hospital of Magenta (Milan, Italy), ASST Ovest Milanese, Pediatric, Neonatal And Neonatal Pathology Units, Magenta (Milan), Italy

Backgrounds: In term or late preterm newborns with infectious diseases (ID) risk is debatable the necessity to perform laboratory analysis compared with the only clinical observation. Quite often, inflammatory blood tests have not a good specificity or sensibility in the first hours/days of life, and a non-accurate blood test interpretation can lead to an inappropriate antibiotic treatment in early life.

Methods: In a retrospective data collection (June to August 2020 and March to May 2021), we collected data of each newborn with ID risk (positive vaginal swab, unknown vaginal swan, prolonged rupture of maternal membranes > 18 hours, maternal fever and suspected chorionamniosis) with the aim to assess the rate of blood tests and antibiotic treatments administered in our department.

Results: From June to August 2020, 290 newborns were admitted with a gestational age more than 34 weeks, and 267 from March to May 2021. 69 (23.8%) of the patients during the three months studied of 2020 vs 57 (21.3%) during 2021 had at least one ID risk factor, 36 (12.4%) during 2020 received blood test to evaluate inflammatory indexes vs 24 (8.9%) during 2021 and 9 (3.1%) received antibiotic treatment during 2020 vs 6 (2.2%) during 2021. Considering patients with ID risk, 27.5% undergo specific blood tests during 2020 vs 19.3% during 2021, and 5.8% during 2020 vs 5.2% during 2021 received antibiotic treatment.

Conclusions/Learning Points: The presence of maternal ID risk factors should be accurately evaluated case by case, to avoid any misdiagnosis of neonatal infection and prevent the risk of over treating with inappropriate antibiotics. Clinical observations of each newborn could be the right way to follow, performing blood tests only in presence of symptoms suspected for ID.

EP603 / #1359

Topic: AS16. Others

PREDICTORS AND FEATURES OF SEVERE RESPIRATORY DISORDERS IN NEWBORNS FROM MOTHERS WITH DIABETES

E-Posters

E-POSTER VIEWING

Veronika Prylutskaya¹, [Kate Serhiyenka](#)², O. Svirskaya³, N. Lybzikova⁴, A. Shevcova⁴

¹Belarussian state medical university, 1st Department Of Children's Diseases, Minsk, Belarus, ²Belarussian state medical university, Children Infection Diseases, Minsk, Belarus, ³Republican Research and Practical Center «Mother and child», -, Минск, Belarus, ⁴Belarussian state medical university, 1st Department Of Children's Diseases, Минск, Belarus

Backgrounds: Type 1 diabetes (T1D) in the mother is a risk factor for the development of severe respiratory disorders (RD) in newborns.

Methods: Prospective single-center study was carried out at the RRPC «Mother and child». We examined 106 full-term newborns from mothers suffering from T1D. Body weight (Me (Q25-Q75)) at birth was 3885 (3370–4480) g, body length 53 cm (46–60) cm. Large for gestational age (LGA) are 65 (61,3%).

Results: The contribution of risk factors was revealed: hypertensive disorders of pregnancy (OR=2.63 (95% CI 1.80–3.86), $\chi^2=4.37$, $p<0.05$), colpitis, urogenital infections (OR=2.34 (1.59–3.45), $\chi^2=4.43$, $p<0.05$), abdominal delivery (OR=2.81 (1.46–5.41), $\chi^2=4.46$, $p<0.05$), insufficiency vitamin D (OR=2.31 (1.58–3.38), $\chi^2=3.80$, $p<0.05$) and macrosomia (OR=3.03 (2.09–4.40), $\chi^2=6.61$, $p<0.01$) in the formation of RD of infectious and non-infectious genesis in newborns from mothers with T1DM. Predictors of the development of severe RD are the features of the underlying mother's disease (high levels of glycated hemoglobin in the mother on the eve and during pregnancy (7.1%), long experience of diabetes (14.0 (7.0–19.5) years).

Conclusions/Learning Points: T1DM in mothers is high-risk factor for the development of RD, even in full-term newborns. Features of the course of severe RD in full-term infants are frequent diagnostics of congenital pneumonia, deviations of physical development (LGA), significantly lower vitamin D provision in newborns.

EP604 / #596

Topic: AS16. Others

PHARYNGITIS, JAUNDICE AND ANEMIA IN A 13-YEAR-OLD FEMALE

E-Posters

E-POSTER VIEWING

Gaja Setnikar Kimovec, Tina Plankar Srovin, Natalija Bahovec, Mojca Rožič, Tanja Avramoska, Maja Arnež, Urška Šivic, Simona Bizjak, Minca Mramor, Petra Prunk Križanec, Aida Granda, Katarina Vincek
University Medical Centre Ljubljana, Department Of Infectious Diseases, Ljubljana, Slovenia

Title of Case: Pharyngitis, Jaundice and Anemia in a 13-year-old female

Background: Epstein-Barr virus (EBV) infection is common in paediatric population and is usually asymptomatic in early childhood. Adolescents commonly have infectious mononucleosis syndrome with fever, pharyngitis, lymphadenopathy, splenomegaly and fatigue. Hematological complications are usually mild, hemolytic anemia is rare and happens in only 1 % to 3 % of patients.

Case Presentation Summary: A 13-year-old, previously healthy female, presented with fever, fatigue, poor appetite and three episodes of vomiting. She had no upper respiratory symptoms or rash. She had a mild cough. She got sick 1 week before being admitted to the hospital. Clinical exam in the local hospital revealed pharyngitis, jaundice, palpable liver margin and mild dehydration.

Learning Points/Discussion: Results: Laboratory test revealed increased reactants of acute phase, normal white blood cell and thrombocyte count, anemia (hemoglobin 71 g/L), increased LDH, increased aminotransferases and hyperbilirubinemia. Direct Coombs test was positive for anti-C3d. Acute EBV infection was confirmed by serological methods. Molecular test for *Mycoplasma pneumoniae* was negative. Patients' lowest hemoglobin value was 70 g/L, she was tachypneic and tachycardic. She received a total of 3 units of red blood cell transfusions, hemoglobin levels dropped significantly approximately 12-20 hours after each transfusion. Due to hemolysis, she received hyperhydration. There was one episode of hyperkalemia, that subsided with hydration and diuretic therapy. After the third transfusion her hemoglobin value was stable and she was discharged. Conclusion: Our patient did not have all the classical symptoms of infectious mononucleosis but she developed hemolytic anemia, which is a rare complication. EBV infection should be considered in any case of hemolytic anemia. In patients with severe hemolytic disease treatment is possible with glucocorticoids, plasmapheresis or rituximab.

EP605 / #1456

Topic: AS16. Others

CLOSTRIDIOIDES DIFFICILE-ASSOCIATED DISEASES IN CHILDREN

E-Posters

E-POSTER VIEWING

D Kulagina¹, Olga Gorbich¹, Tatyana Artsemchik², Olga Simachenko²

¹Belarusian state medical university, Hygiene Of Children And Adolescents, Minsk, Belarus, ²Belarusian state medical university, Pediatric Infectious Diseases, Minsk, Belarus

Backgrounds: Identification of risk factors for the development of Clostridioides difficile-associated infections, as well as the features of this nosological form among children.

Methods: A controlled analytical research of the "case-control" type included 11 patients admitted to the Healthcare Institution "City Children's Clinical Hospital of Infectious Diseases" in Minsk in the period 2015-2020. Data processing and analysis of the research results were carried out using Microsoft Excel.

Results: The widespread use of antibiotic therapy throughout the world has led to an increase in complications such as antibiotic-associated diarrhea and colitis. According to the results of the research, the average age of patients with this nosological form was 8 years, the percentage of girls with C. difficile-associated infection was 72%. It was found that children aged 0-6 years prevailed among the sick (54.5%). One of the risk factors for the severe course of CDI was the presence of comorbidities, such as primary immunodeficiency. When analyzing antibacterial agents used in therapy for patients with CDI, it was found that preference was given to vancomycin (45.4%) and metronidazole (27.2%).

Conclusions/Learning Points: The risk factors for the development of C. difficile-associated infection among hospitalized children were age under 6 years and the presence of concomitant diseases.

EP606 / #488

Topic: AS16. Others

ARTHROBACTER OXYDANS BACTEREMIA: FIRST PAEDIATRIC CASE IN GREECE

E-Posters

E-POSTER VIEWING

Kalliopi Spyridopoulou¹, Giorgos Paradeisis¹, Sophia Zisi¹, Anna Simou², Ioanna Marsellou², Angeliki Stathi¹, Maria Filippidou³, Sofia Chante³, Levantia Zachariadou¹

¹"Aghia Sophia" Children's Hospital, Microbiology, Athens, Greece, ²BIOMEDICINE S.A., Mycology Laboratory, Athens, Greece, ³National and Kapodistrian University of Athens/Aghia Sophia Children's Hospital, Medical School, First Department Of Paediatrics/haematology-oncology Unit Unit, Athens, Greece

Title of Case: ARTHROBACTER OXYDANS BACTEREMIA: FIRST PAEDIATRIC CASE IN GREECE

Background: Arthrobacter is a genus of Gram-positive obligate aerobic soil bacteria. First isolated from human specimens in 1996, it has been documented as a cause of human infection on extremely limited occasions. The first case of Arthrobacter spp. bacteremia in an oncology paediatric patient in Greece is reported.

Case Presentation Summary: A 3-year-old boy, recently diagnosed with a Primitive neuroectodermal tumor of the posterior fossa with leptomeningeal dissemination, classified as Group 3 medulloblastoma based on DNA methylation analysis, was admitted to the oncology unit due to fever 38.2°C with no other clinical findings, 14-days after the first chemotherapy cycle (Carboplatin/Etoposide). Laboratory tests revealed a WBC count of 10,510cells/μL(77.6% lymphocytes), double increased within 24-hours, and a C-reactive-protein level of 7.24 mg/L, reaching 20.4mg/L within three days. Blood cultures from the Hickman catheter and a peripheral site were collected and antibiotic therapy with piperacillin/tazobactam and teicoplanin was started. On the fifth day of incubation, Hickman blood culture taken before antibiotic administration revealed a coryneform Gram-positive aerobic rod. Vitek2-compact (BioMérieux) failed to identify the isolate, whereas MALDI-TOF MS-Biotyper3.1 (BRUKER) identified it as Arthrobacter oxydans(score 2.32). Antibiotic MIC-testing (E-test method) showed sensitivity to penicillin, piperacillin/tazobactam, teicoplanin, meropenem, ciprofloxacin, linezolid, tetracycline, gentamicin, erythromycin, clindamycin, co-trimoxazole and rifampicin. Clinical and laboratory findings normalized within three and five days respectively and antibiotic therapy lasted 14 days. Clinicians attributed the fever to the isolated pathogen.

Learning Points/Discussion: Arthrobacter is an extremely rare bloodstream pathogen and, also, rarely recovered from other clinical samples. To our knowledge, this is the first A.oxydans bacteremia reported in Greece. The source of A.oxydans in this case remains unknown. Identification of A.oxydans demands the use of proteomic and other not conventional methods.

EP607 / #454

Topic: AS16. Others

UNUSUAL PREDISPOSING FACTORS FOR PAEDIATRIC MUCORMYCOSIS: A CASE SERIES

E-Posters

E-POSTER VIEWING

Keang Suy¹, Arjun Chandna^{1,2}, Thyl Miliya¹, Vorlark Meas³, Nara Leng³, Paul Turner^{1,2}

¹Angkor Hospital for Children, Cambodia Oxford Medical Research Unit, Siem Reap, Cambodia, ²University of Oxford, Centre For Tropical Medicine And Global Health, Nuffield Department Of Medicine, Oxford, United Kingdom, ³Angkor Hospital for Children, Medical, Siem Reap, Cambodia

Title of Case: UNUSUAL PREDISPOSING FACTORS FOR PAEDIATRIC MUCORMYCOSIS: A CASE SERIES

Background: Mucormycosis is a rare, life-threatening fungal infection. We report three cases of paediatric mucormycosis at Angkor Hospital for Children, Cambodia.

Case Presentation Summary: Patient A was a previously healthy 8-year-old boy transferred from another hospital with suspected acute leukaemia. He had been hospitalised for an acute febrile illness with pancytopenia and epistaxis. Flow cytometry from a bone marrow aspirate was normal and pancytopenia resolved. Progressive necrotic periorbital ulceration developed. An old gauze, used to control epistaxis, was discovered at surgical debridement. Multiple tissue cultures grew *Rhizopus arrhizus*, identified by MALDI-ToF. The patient recovered after repeated debridement and amphotericin B. Patient B was a previously healthy 14-year-old boy who presented with left eye pain and reduced vision one week after falling from a tractor into mud. A fractured zygoma and acute glaucoma were diagnosed. Pain worsened over four days, with development of periorbital swelling which progressed to necrosis. Tissue taken during debridement grew *Mucormycota* spp., identified by colony appearance and lactophenol blue stain. Despite repeated debridement and amphotericin B, the patient died. Patient C was a 5-month-old child hospitalised with severe pneumonia and severe acute malnutrition. She developed a necrotic lesion on her anterior chest wall where an ECG lead had been placed for cardiac monitoring. *Rhizopus microsporus* grew from debrided tissue, identified by MALDI-ToF. Amphotericin B was started but, unfortunately, the patient died.

Learning Points/Discussion: Whilst none of these children had a history of haemato-oncological immunosuppression, all had impairment of their innate (breach of skin barrier) or adaptive (severe malnutrition) immune systems. Being alert to uncommon risk factors in patients presenting with progressive, necrotic soft-tissue lesions could hasten diagnosis and improve patient outcomes.

EP609 / #631

Topic: AS16. Others

EPIDEMIOLOGICAL CHARACTERISTICS OF HOSPITALIZED PEDIATRIC PATIENTS WITH COVID-19: A SYSTEMATIC REVIEW

E-Posters

E-POSTER VIEWING

Christos Triantafyllou¹, Vasileios Triantafyllou², Maria Gamvrouli³

¹Center for Clinical Epidemiology and Outcomes Research (CLEO), Non-profit Civil Partnership, Athens, Greece, ²University of Western Attica, Department Of Biomedical Engineering, Athens, Greece, ³National and Kapodistrian University of Athens, Department Of Nursing, Athens, Greece

Backgrounds: The COVID-19 global pandemic caused by severe acute respiratory syndrome coronavirus 2 (SARS-CoV-2) infection, warranted attention for whether it has unique manifestations in children. The aim of this systematic review was to present the epidemiological characteristics of hospitalized pediatric patients with COVID-19.

Methods: A systematic search up to September 2021 was conducted in PubMed and IATROTEK-online databases with the key-words: "mortality", "Pediatric Intensive Care Unit", "Paediatric Intensive Care Unit", "PICU", and "COVID-19", without time limit for the publication of scientific papers. Moreover, cited references from selected articles were used to find additional studies that were not retrieved in the initial search. Studies eligible for inclusion were those that were published in English and Greek, were case-control or cohort studies of children aged ≤ 18 years old hospitalized with COVID-19, and the full text was available. Study quality was evaluated using the Critical Appraisal Skills Programme Tool (CASP) for cohort and case-control studies.

Results: Of 30 papers identified in the search, 9 were included. The results of the nine studies showed that out of the total of 1886 pediatric patients with COVID-19, 33 died (1.74%), 548 (29%) were hospitalized in PICU, and 4.1% of the pediatric patients with COVID-19 (60/1452) required either invasive or non-invasive mechanical ventilation.

Conclusions/Learning Points: The results of this systematic review indicate that although a significant number of the hospitalized children with COVID-19 require careful supportive intensive care, the mortality rate is low. This highlights the importance of vaccinating children against SARS-CoV-2 and of the implementation of personal hygiene measures, in order to significantly reduce the risk of severe illness and the development of complications of COVID-19.

EP610 / #1463

Topic: AS16. Others

TWITTER AS AN EDUCATIONAL IMPACT TOOL FOR PEDIATRIC INFECTIOUS DISEASE (#PEDSID) CONFERENCES: EXPERIENCE OF THE VIRTUAL CONFERENCE OF THE SOCIEDAD LATINOAMERICANA DE INFECTOLOGÍA PEDIÁTRICA (#SLIPE2021)

E-Posters

E-POSTER VIEWING

Rolando Ulloa-Gutierrez¹, Maria Avila-Aguero¹, Xavier Sáez-Llorens², Soraya Castro³, Juan Pablo Torres⁴, Pio Lopez⁵, Roberto Debbag⁶

¹Hospital Nacional de Niños "Dr. Carlos Sáenz Herrera", Centro de Ciencias Médicas, Caja Costarricense de Seguro Social (C.C.S.S.), Servicio De Infectología Pediátrica, San José, Costa Rica, ²Hospital del Niño Dr. José Renán Esquivel, Servicio De Infectología, Ciudad de Panama, Panama, ³Instituto Materno Infantil y de Especialidades, Servicio De Pediatría, Santiago, Dominican Republic, ⁴Hospital de Niños "Dr. Luis Calvo Mackenna, Universidad de Chile, Department Of Pediatrics, Division Of Pediatric Infectious Diseases, Santiago, Chile, ⁵Centro de Estudios de Infectología Pediátrica, Dirección Médica, Cali, Colombia, ⁶Hospital Garrahan, Servicio De Infectología Y Telemedicina, Buenos Aires, Argentina

Backgrounds: Despite the emergence of new agents such as the latest SARS-CoV2, Twitter use by pedsID subspecialists remains low if compared to other pediatric subspecialties (i.e. #pedsICU). The objective of this novel study is to describe the impact of live tweeting during a pedsID society conference.

Methods: The bi-annual conference of SLIPE society was held virtually from Buenos Aires, Argentina from October 13-15, 2021 (<https://www.slipe2021.org>). Around 12,400 persons registered for the conference; however, ~ 7,500 were active participants in the platform. A full-day pre-conference workshop for young investigators was held on October 12 as well. Twitter activity of the official #SLIPE2021 hashtag was measured through Symplur® (<https://www.symplur.com>). We excluded Tweets with no hashtags.











Results: From October 1 to October 30, 2021, a total of 544 Tweets using the #SLIPE2021 hashtag were made by 149 participants, with an average of 1 Tweet per hour and 4 tweets by participants. An approximate ~9,121,000 impressions of tweets around the world were registered during the 30-day period (Figure 1), specially from Latin America. Although most tweets and impressions were posted during days 3 and 4 of the conference, activity remained also in the next 5 days after the conference was finished and decreased thereafter.

Conclusions/Learning Points: Twitter can be a strong and useful social media network for virtually reaching health care workers, including pediatricians and infectious disease experts. Although we missed important tweets without hashtags, the use of conference hashtags by attendees and influencers facilitates not only the registry and measurement of this social media tool, but also to diffuse updated pedsID

knowledge.











The #SLIPE2021 Influencers

Top 10 Influential

-  [@SLIPEcongreso](#) 100
-  [@rolandoug](#) 85
-  [@Maluavi](#) 83
-  [@jptorrest](#) 74
-  [@SorayaCastroLL](#) 71
-  [@dr_rdebbag](#) 70
-  [@sochipe](#) 68
-  [@edu_lopezmed](#) 65
-  [@healthhashtags](#) 61
-  [@camachomgerman](#) 60











 Tweet

Prolific Tweeters

-  [@SLIPEcongreso](#) 94
-  [@rolandoug](#) 73
-  [@Maluavi](#) 56
-  [@SorayaCastroLL](#) 36
-  [@xsaeszll](#) 24
-  [@csarahmotat](#) 20
-  [@MilciadesCP](#) 11
-  [@_AGEI](#) 9
-  [@NancyVir](#) 7
-  [@dr_rdebbag](#) 7

 Tweet

Highest Impressions

-  [@Maluavi](#) 5.3M
-  [@xsaeszll](#) 2.4M
-  [@PeterHotez](#) 228.4K
-  [@csarahmotat](#) 148.1K
-  [@rolandoug](#) 126.6K
-  [@dr_rdebbag](#) 116.6K
-  [@Nopanaden](#) 106.8K
-  [@SorayaCastroLL](#) 100.3K
-  [@NancyVir](#) 75.6K
-  [@SLIPEcongreso](#) 66.7K

 Tweet

The Numbers

9.121M Impressions

544 Tweets

149 Participants

1 Avg Tweets/Hour

4 Avg Tweets/Participant

 Tweet

Twitter data from the #SLIPE2021 hashtag from Fri, October 1st 2021, 12:00AM to Sat, October 30th 2021, 12:00AM (America/Costa_Rica) – Symplur.



Top 10 Influencers is determined by the SymplurRank algorithm.

EP611 / #963

Topic: AS16. Others

TRANSFER OF MATERNAL ANTIBODIES OF ALL ISOTYPES THROUGH MILK, CORD BLOOD AND AMNIOTIC FLUID.

E-Posters

E-POSTER VIEWING

Arthur Van Stigt¹, Anneke Hellinga¹, Daphne Van Meerwijk¹, Maaïke Nederend¹, Christianne Lammers¹, Kitty Bloemenkamp², Gerco Den Hartog³, Joanne Wildenbeest⁴, Belinda Van 'T Land^{1,5}, Louis Bont⁶, Jeanette Leusen¹

¹University Medical Center Utrecht, Center For Translational Immunology, Utrecht, Netherlands, ²University Medical Center Utrecht, Gynaecology And Obstetrics, Utrecht, Netherlands, ³Centre for Infectious Disease Control, National Institute for Public Health and the Environment (RIVM), Centre For Immunology Of Infectious Diseases And Vaccines, Bilthoven, Netherlands, ⁴University Medical Center Utrecht, Paediatric Immunology And Infectious Disease, Utrecht, Netherlands, ⁵Danone Nutricia Research, Department Of Immunology, Utrecht, Netherlands, ⁶ReSViNET foundation, Resvinet Foundation, Zeist, Netherlands

Backgrounds: Maternal vaccines are well-established vaccination strategies for several infections like influenza and pertussis. Antibody transfer through placenta and cord blood is assumed to be the most important route of transfer of maternal immunity. Human milk and amniotic fluid also contain antibodies. Specific antibodies in breastfeeding are associated with protection from infections in neonates. Amniotic fluid also contains antibodies that can neutralize RSV in vitro and protect mice pups in in vivo models. Very little is known about the difference in antibody composition between these three media and their contribution in protection from infections. More insight into these three pathways of maternal immunity transfer is vital for improving maternal vaccines.

Methods: The PRIMA transfer study is designed to compare antibody repertoires between cord blood, breastfeeding and amniotic fluid. Amniotic fluid and cord blood are collected at birth, and human milk and maternal blood are sampled in the first week postpartum. This is the first study as far as we know in which all human antibody isotypes are analyzed in these samples.

Results: Overall, total antibody levels are lower in cord blood, human milk and amniotic fluid compared to maternal serum. Human milk is enriched for IgA1 and IgA2 (76.35% and 15.45% respectively in human milk, 18.53% and 3.66% in maternal serum), cord blood and amniotic fluid are enriched for IgG1 and IgG2 (25.97% and 67.94% in cord blood, 27.62% and 54.92% in amniotic fluid, 14.35% and 45.16% in maternal serum). Amniotic fluid is also enriched for IgE and IgG4 (0.17% and 1.21% in amniotic fluid, 0.02% and 0.56% in maternal serum).

Conclusions/Learning Points: These data indicate that different isotypes are selectively transported into these media, possibly to offer optimal protection against pathogens at different sites.

EP612 / #1542

Topic: AS16. Others

PEDIATRIC DEEP NECK INFECTIONS: OUTCOMES IN A TWELVE-YEAR SERIES OF A TERTIARY HOSPITAL IN SOUTHERN SPAIN.

E-Posters

E-POSTER VIEWING

Álvaro Vázquez-Pérez¹, Juan Luis Santos Pérez²

¹Hospital Universitario Materno-Infantil Virgen de las Nieves, Pediatrics, Granada, Spain, ²Hospital Virgen de las Nieves, Pediatric Unit, Granada, Spain

Title of Case: PEDIATRIC DEEP NECK INFECTIONS: OUTCOMES IN A TWELVE-YEAR SERIES OF A TERTIARY HOSPITAL IN SOUTHERN SPAIN.

Background: Deep neck infections (DNI) often have a rapid onset and can progress to life-threatening complications. Their diverse clinical picture can have an impact on the difficulty of its initial diagnosis since it is not commonly suspected in the context of oropharyngeal infections. This study aimed to analyse the epidemiology, clinical presentation, and diagnostic clues of children with DNI.

Case Presentation Summary: METHODS A retrospective clinical record review of patients (aged < 14 years) diagnosed with acute neck infections (ANI), admitted to a tertiary university hospital in Granada (Andalusia, Spain) from January 2007 to June 2019, was performed. Adenitis, peritonsillar abscesses, and DNI cases were included. RESULTS A total of 144 with acute neck infections (ANI) were identified. Half of the cases with ANI (73, 51%) corresponded to peritonsillar abscesses and 63 (44%) to adenitis. Eight patients were diagnosed with DNI (6%). Regarding DNI, most of the patients were male (62%). The median age was 4 years (IQR: 2-5). The most common clinical presentation was neck mass or swelling (62%) and torticollis (50%). 65 % of the cases were initially diagnosed as adenitis. Surgery was performed in 62% patients. There was no long-term morbidity or mortality.

Learning Points/Discussion: DNI are challenging infections that should be suspected in the presence of guide symptoms, such as torticollis. Among other complications, they can also cause venous thromboembolism. DNI has to be suspected in oropharyngeal infections with unfavourable evolution, and cardinal symptoms like torticollis. It is frequent the confusion of reactive adenopathy with adenitis. DNIs present high morbidity in the absence of treatment, but with a good early infection control, complications can be avoided.

EP614 / #1093

Topic: AS16. Others

A POPULATION BASED STUDY OF THE EPIDEMIOLOGY OF SEPSIS IN INFANTS IN MALTA

E-Posters

E-POSTER VIEWING

Gerd Xuereb, David Pace

Mater Dei Hospital, Department Of Child & Adolescent Health, MSIDA, Malta

Backgrounds: Sepsis is an important childhood disease, yet epidemiological data in Malta are limited. We aimed to study the incidence and aetiology of sepsis in the first year of life in Malta.

Methods: Positive blood cultures from all infants outside of the neonatal period (29 days-<1 year) taken between January 2009 and December 2020 at Mater Dei Hospital, which is the only hospital for the whole population in Malta, were collected and analysed retrospectively. Organisms that are usual contaminant lines were excluded. The incidence and aetiology of sepsis outside the neonatal period were determined.

Results: Over the 12 year study period there were 132 culture-proven episodes of sepsis during infancy. The mean age was 3.56 months (95% CI: 3.33-4.39) and 57% of patients were males. The incidence rate of culture-proven sepsis during infancy was 2.56 per 1000 live births. The incidence of Gram-negative bacteremia in infancy was 1.49 per 1000 live births and that of Gram-positive bacteria sepsis was 1.05 per 1000 live births.

The most common causes of sepsis in infancy were *Escherichia coli* (0.54/1000 live births), *Klebsiella pneumoniae* (0.21/1000 live births), *Streptococcus pneumoniae* (0.21/1000 live births) and *Neisseria meningitidis* (0.17 per 1000 live births), Methicillin sensitive *Staphylococcus aureus* (0.17/1000 live births), and Methicillin-resistant *Staphylococcus aureus* (0.17/1000 live births each).

Conclusions/Learning Points: Bacterial sepsis is still an important cause for hospitalisation of infants. In Malta the initial empiric antibiotic regimens for infantile sepsis should ensure appropriate cover for the most frequent pathogens isolated.